



CITROËN JUMPY

HANDBOOK

CRÉATIVE TECHNOLOGIE



On-line handbook

Select one of the following means of access to view your handbook on-line...

Referring to the handbook on-line also gives you access to the latest information available, easily identified by the bookmark, associated with this symbol:



MyCITROËN

Find your handbook on the CITROËN website, under "MyCITROËN".

This personal and customisable space allows you to establish direct and special contact with the manufacturer.

If the "MyCITROËN" function is not available on the CITROËN public website for your country, you can find your handbook at the following address:

<http://service.citroen.com/ddb/>

Select:

- > the language,
 - > the vehicle, its body style,
 - > the print edition of your handbook appropriate for the date of registration of your vehicle.
-

Scan this code for direct access to your handbook.





This handbook has been designed to help you to make the most of your vehicle in all situations and in complete safety.

Take the time to read through it so as to familiarise yourself with your vehicle.

Key

 safety warning

 additional information

 contributes to the protection of the environment

Key

This key will enable you to identify the special features of your vehicle:

 Van

 Crew cab with manual child lock

 Crew cab with electric child lock

 Combi

This handbook covers all of the variations in equipment available across the whole range.

Your vehicle will be fitted with only some of the equipment described in this document, depending on its trim level, version and the specification for the country in which it was sold.

The descriptions and illustrations are given as indications only.

Automobiles CITROËN reserves the right to modify the technical characteristics, equipment and accessories without having to update this edition of the handbook.

This document forms an integral part of your vehicle.

Remember to pass it on to the new owner in the event of the sale of the vehicle.

CITROËN has a presence on every continent,

a complete product range,

bringing together technology and a permanent spirit of innovation,

for a modern and creative approach to mobility.

We thank you and congratulate you on your choice.

At the wheel of your new vehicle,

getting to know each system,

each control, each setting,

makes your trips, your journeys

more comfortable and more enjoyable.

Happy motoring!

Contents

| | | | | | | | | |
|---------------------------------|--------------------|----------|--------------------------------------|--------------------------------|----------|---|--------------------------------|----------|
| | Overview | 1 | | Ease of use and comfort | 3 | | Lighting and visibility | 4 |
| Labels | | 11 | Steering wheel adjustment | | 99 | Mirrors | | 143 |
| | Eco-driving | | Front seats | | 99 | Lighting control stalk | | 146 |
| | | | 2-seat front bench seat | | 104 | Daytime running lamps | | 149 |
| | Instruments | 1 | Moduwork | | 106 | Automatic illumination of headlamps | | 149 |
| Instrument panels | | 14 | Fixed one-piece bench seat | | 110 | Automatic headlamp dipping | | 153 |
| Indicator and warning lamps | | 17 | Fixed rear seat and bench seat | | 113 | Manual headlamp beam height adjustment | | 155 |
| Engine coolant temperature | | 31 | Fixed crew cab | | 117 | Wiper control stalk | | 156 |
| Distance recorders | | 38 | Interior fittings | | 119 | Automatic rain sensitive wipers | | 157 |
| Lighting dimmer | | 39 | Loading area fittings | | 122 | | | |
| Trip computer | | 40 | Seating area fittings | | 123 | | | |
| Touch screen | | 43 | Heating / Ventilation | | 125 | | | |
| Setting the date and time | | 46 | Manual air conditioning | | 126 | | | |
| | Access | 2 | Dual-zone automatic air conditioning | | 128 | | | |
| Key | | 47 | Front demist - defrost | | 132 | | | |
| Key, remote control | | 47 | Door mirrors demist - defrost | | 133 | | | |
| "Keyless Entry and Starting" | | 55 | Rear screen demist - defrost | | 134 | | | |
| Locking / unlocking from inside | | 72 | Rear Heating - Air Conditioning | | 137 | | | |
| Front doors | | 74 | Programmable Heating / Ventilation | | 138 | | | |
| Manual sliding side door(s) | | 75 | Courtesy lamp(s) | | 141 | | | |
| Electric sliding side door(s) | | 78 | | | | | | |
| Hands-free sliding side door(s) | | 87 | | | | | | |
| Side-hinged rear doors | | 91 | | | | | | |
| Tailgate | | 94 | | | | | | |
| Alarm | | 95 | | | | | | |
| Electric windows | | 98 | | | | | | |
| | | | | | | | Safety | 5 |
| | | | | | | Hazard warning lamps | | 160 |
| | | | | | | Emergency or assistance call | | 160 |
| | | | | | | Horn | | 161 |
| | | | | | | Electronic stability control (ESC) | | 161 |
| | | | | | | Grip control | | 164 |
| | | | | | | Seat belts | | 166 |
| | | | | | | Airbags | | 170 |
| | | | | | | Child seats | | 174 |
| | | | | | | Deactivating the passenger's front airbag | | 177 |
| | | | | | | ISOFIX mountings | | 186 |
| | | | | | | Manual child lock | | 194 |
| | | | | | | Electric child lock | | 194 |
| | | | | | | Child lock on rear windows | | 195 |

| | | | | | |
|--|----------|--|----------|-------------------------|----------|
| Driving | 6 | Practical information | 7 | Technical data | 9 |
| Driving recommendations | 196 | Fuel tank | 265 | Dimensions | 328 |
| Starting-switching off the engine, manual key, remote control | 199 | Diesel misfuel prevention | 266 | Engines | 332 |
| Starting and switching off the engine, "Keyless Entry and Starting" | 202 | Snow chains | 268 | Weights | 332 |
| Parking brake | 205 | Towing a trailer | 269 | Identification markings | 337 |
| Hill start assist | 206 | Energy economy mode | 270 | | |
| 5-speed manual gearbox | 207 | Accessories | 271 | | |
| 6-speed manual gearbox | 207 | Roof bars / Roof rack | 273 | | |
| Gear shift indicator | 208 | Changing a wiper blade | 274 | | |
| Automatic gearbox | 209 | Bonnet | 276 | | |
| Electronic gearbox | 214 | Diesel engine | 277 | | |
| Stop & Start | 218 | Checking levels | 278 | | |
| Head-up display | 222 | Checks | 281 | | |
| Memorising speeds | 224 | AdBlue® and SCR system (BlueHDi Diesel) | 283 | | |
| Speed limit recognition | 225 | | | Audio and telematics | |
| Speed limiter | 229 | | | Emergency or assistance | 338 |
| Cruise control | 232 | | | CITROËN Connect Nav | 341 |
| Dynamic cruise control | 236 | | | CITROËN Connect Radio | 429 |
| Collision Risk Alert and Active Safety Brake | 243 | | | Bluetooth® audio system | 483 |
| Lane departure warning system | 248 | | | | |
| Fatigue detection system | 250 | In the event of a breakdown | 8 | | |
| Blind spot monitoring system | 252 | Warning triangle (stowing) | 287 | | |
| Parking sensors | 255 | Tool box | 287 | | |
| Reversing camera, interior mirror | 258 | Temporary puncture repair kit | 290 | | |
| 180° rear vision | 259 | Changing a wheel | 296 | | |
| Under-inflation detection | 262 | Changing a bulb | 303 | | |
| | | Changing a fuse | 316 | | |
| | | 12 V battery | 321 | | |
| | | Towing | 325 | | |
| | | Running out of fuel (Diesel) | 327 | Alphabetical index | |

Exterior

| | |
|-------------------------|--------------|
| Speed limit recognition | 225-228 |
| Collision Risk Alert | 243-245 |
| Active Safety Brake | 243, 246-248 |
| Fatigue detection | 250-251 |

| | |
|-----------------------------|---------|
| Changing a wiper blade | 274 |
| Automatic wiping | 157-158 |
| Front demisting, defrosting | 132 |

| | |
|--------------------|-----|
| Opening the bonnet | 276 |
|--------------------|-----|

| | |
|---|---------|
| Automatic illumination of headlamps | 149 |
| Automatic headlamp dipping | 153-154 |
| Direction indicators | 148 |
| Manually adjusting the headlamp beam height | 155 |
| Changing front bulbs | 303-309 |
| Headlamp wash | 158 |

| | |
|-----------------|---------|
| Parking sensors | 255-257 |
| Towing | 325-326 |

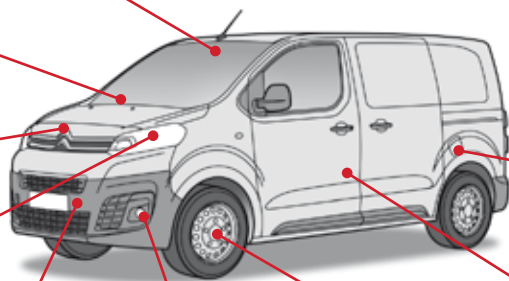
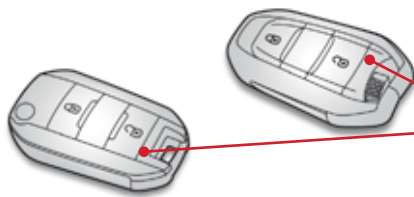

| | |
|-----------------------|----------|
| Front foglamps | 147, 309 |
| Daytime running lamps | 149, 305 |
| Cornering lighting | 152 |

| | |
|---|---------|
| Key | 47 |
| Key, remote control | 47-54 |
| Changing the battery, reinitialisation | 54 |
| Keyless Entry and Starting | 55-71 |
| Changing the battery, reinitialisation | 70 |
| Starting - switching off the engine, key, remote control | 199-201 |
| Starting - switching off the engine, Keyless Entry and starting | 202-204 |
| Locking / unlocking from inside | 72-73 |
| Alarm | 95-97 |

| | |
|-------------------------------------|---------|
| Filler cap, fuel tank | 265-266 |
| Misfuel prevention | 266-267 |
| Running out of Diesel fuel, priming | 327 |

| | |
|--------------|---------|
| Front doors | 74-75 |
| AdBlue® tank | 283-286 |
| Tool box | 287-289 |

| | |
|---------------------------|--------------|
| Under-inflation detection | 262-264 |
| Tyres, pressures | 263-264, 337 |
| ESC programme | 161-163 |
| ABS, EBFd | 162 |
| DSC, ASR | 163 |
| Grip control | 163, 164-165 |
| Snow chains | 268 |

Exterior (continued)

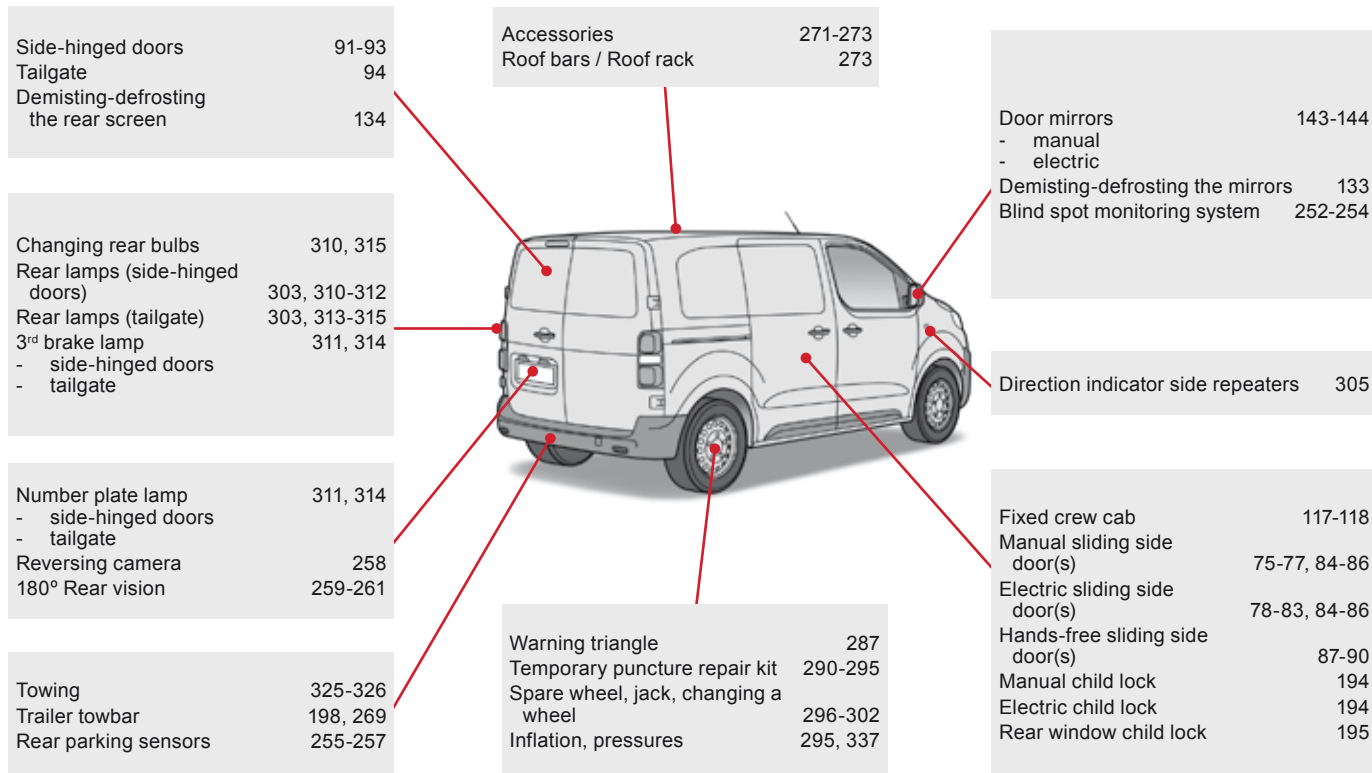

Instruments and controls

| | |
|-----------|-----|
| Air vents | 135 |
|-----------|-----|

| | |
|------------------------------|-----|
| Adjusting the manual mirrors | 143 |
|------------------------------|-----|

| | |
|---|---------|
|  Dashboard fuses | 316-318 |
|---|---------|

| | |
|--------------------|-----|
| Opening the bonnet | 276 |
|--------------------|-----|

| | |
|--------------------------|---------|
| 5/6-speed manual gearbox | 207 |
| Gear shift indicator | 208 |
| Automatic gearbox | 209-213 |
| Electronic gearbox | 214-217 |
| Stop & Start | 218-221 |
| Hill start assist | 206 |

| | |
|-------------------------------------|--------------|
| Courtesy lamps | 141-142 |
| Rear view mirror | 145 |
| Reversing camera on interior mirror | 258 |
| Emergency or assistance call | 160, 338-339 |

| | |
|---------------|-----|
| Parking brake | 205 |
|---------------|-----|

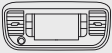
| | |
|--|----------------|
|  Touch screen (CITROËN Connect Nav) | 43-45, 341-428 |
| Touch screen (CITROËN Connect Radio) | 43-45, 429-482 |

| | |
|---|-------------|
|  Bluetooth® audio system | 46, 483-505 |
| Setting the date and time | 46 |

| | |
|--------------------------------------|---------------|
| Heating / Ventilation | 125 |
| Manual air conditioning | 126-127 |
| Automatic dual-zone air conditioning | 128-131 |
| Rear heating, air conditioning | 137 |
| Air recirculation | 125, 126, 131 |
| Front demist / defrost | 132 |
| Rear screen demist / defrost | 134 |

| | |
|---|----------|
| 12 V accessory socket | 121 |
| USB port / JACK auxiliary socket | 122 |
| Deactivating the passenger front airbag | 172, 177 |

Instruments and controls (cont.)

| | | |
|--|------------------------|--|
| Instrument panel | 14-16 | |
| Warning lamps | 17-30 | |
| Coolant temperature | 31 | |
| Service indicator | 31-33 | |
| Oil level indicator | 34 | |
| AdBlue® range indicator | 35-37 | |
| Distance recorder | 38 | |
| Gear shift indicator | 208 | |
| Lighting dimmer | 39 | |
| Trip computer | 40-42 | |
| Setting the time and date | 46 | |
| Fatigue detection | 250-251 | |
| Electric windows | 98 | |
| Adjusting the electric mirrors | 143 | |
| Lighting control | 146-151 | |
| Direction indicators | 148 | |
| Grip control | 163, 164-165 | |
| Programmable heating / ventilation | 138-140 | |
| Alarm | 95-97 | |
| Manually adjusting the headlamp beam height | 155 | |
| Lane departure warning system | 248-249 | |
| Blind spot monitoring system | 252-254 | |
| Automatic headlamp dipping | 153-154 | |
| Head-up display | 222-223 | |
| Memorising speeds | 224 | |
| Speed limiter | 229-231 | |
| Cruise control | 232-235 | |
| Dynamic cruise control | 236-242 | |
| Setting the time and date | 46 | |
| 180° Rear vision | 259-261 | |
| Memorising speeds | 224 | |
| Speed limit recognition | 225-228, 231, 234, 238 | |
| Collision Risk Alert | 243-245 | |
| Active Safety Brake | 243, 246-249 | |
| Deactivating Stop & Start | 220 | |
| Wiper control | 156-159 | |
| Trip computer | 40-42 | |
| Locking/unlocking from inside | 72-73 | |
| Electric sliding door(s) | 78-86 | |
| Cabin / loading area selectivity | 47-48, 55 | |
| Electric child lock | 194 | |
| Hazard warning lamps | 160 | |
| Reinitialising the under-inflation detection | 263-264 | |
| Deactivating Stop & Start | 220 | |
| Deactivating the DSC/ASR system | 163 | |
| Adjusting the steering wheel | 99 | |
| Horn | 161 | |



Interior

| | |
|---|---------|
| Interior fittings | 119-122 |
| - cup/can holder | |
| - mats | |
| - sun visors | |
| - glove box | |
| - storage box | |
| - upper storage box | |
| - accessory socket, USB port, JACK auxiliary socket | |
| Tool box | 287-289 |

| | |
|------------------------|---------|
| Front seats | 99-103 |
| - manual adjustments | |
| - electric adjustments | |
| - head restraints | |
| - heated seats | |
| Seat belts | 166-168 |

| | |
|------------------------------|-----|
| Rear courtesy lamps | 141 |
| Changing courtesy lamp bulbs | 312 |

| | |
|----------------|---------|
| Fixed crew cab | 117-118 |
|----------------|---------|

| | |
|-------------------------|---------|
| Loading area fittings | 122-123 |
| - lashing rings | |
| - loading area bulkhead | |
| Accessories | 271-273 |

| | |
|-------------------------------------|------------------|
| Temporary puncture repair kit | 287-289, 290-295 |
| Spare wheel, jack, changing a wheel | 287-289, 296-302 |

| | |
|------------------------------|-----|
| Interior rear view mirror | 145 |
| Front courtesy lamp | 141 |
| Changing courtesy lamp bulbs | 312 |

| | |
|---|----------|
| Airbags, front, lateral | 170-173 |
| Deactivating the passenger front airbag | 172, 177 |
| 12 V accessory socket | 121 |
| USB port | 122 |
| JACK auxiliary socket | 122 |

| | |
|-------------------------|---------|
| 2-seat front bench seat | 104-105 |
| Heated bench seat | 105 |
| Moduwork | 106-109 |
| Work table | 109 |
| Child seats | 174-183 |

| | |
|-----------------------------------|---------|
| ISOFIX mountings (fixed crew cab) | 186-189 |
|-----------------------------------|---------|

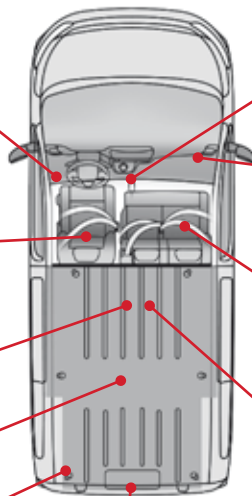



Interior

| | |
|---|---------|
| Interior fittings | 119-122 |
| - cup/can holder | |
| - mats | |
| - sun visors | |
| - glove box | |
| - storage box | |
| - upper storage box | |
| - accessory socket, USB port, JACK auxiliary socket | |
| Tool box | 287-289 |

| | |
|--|---------|
| Front seats, adjustments, head restraint | 99-103 |
| - manual adjustments | |
| - electric adjustments | |
| - table position | |
| - head restraints | |
| - heated seats | |
| Seat belts | 166-168 |

| | |
|--------------------------------|---------|
| Fixed one-piece bench seat | 110-112 |
| Rear seat and fixed bench seat | 113-115 |
| Seat labels | 116 |

| | |
|------------------------------|-----|
| Rear courtesy lamp | 142 |
| Changing courtesy lamp bulbs | 312 |

| | |
|---------------------------|---------|
| Seating area fittings | 123-124 |
| - high load retaining net | |
| - rear windows | |
| Accessories | 271-272 |

| | |
|------------------------------|-----|
| Rear view mirror | 145 |
| Front courtesy lamp | 142 |
| Changing courtesy lamp bulbs | 312 |

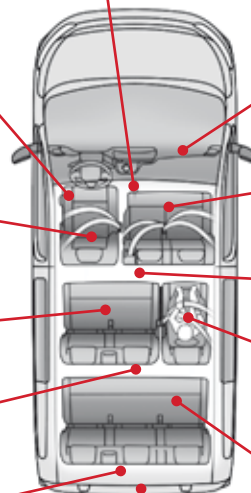

| | |
|---|----------|
| Front, side airbags | 170-173 |
| Deactivating the passenger front airbag | 172, 177 |
| 12 V accessory sockets | 121 |
| USB port | 122 |
| JACK auxiliary socket | 122 |

| | |
|-------------------------|---------|
| 2-seat front bench seat | 104-105 |
| Heated bench seat | 105 |

| | |
|---------------------------------|-----|
| Rear heating - air conditioning | 137 |
|---------------------------------|-----|

| | |
|-------------------|------------------|
| Child seats | 174-181, 184-185 |
| ISOFIX mountings | 186-187, 190-192 |
| Rear side windows | 124, 195 |

| | |
|--|------------------|
| Temporary puncture repair kit | 287-289, 290-295 |
| Spare wheel, jack, changing a wheel, tools | 287-289, 296-302 |

| | |
|--------------------------------|---------|
| Fixed one-piece bench seat | 110-112 |
| Rear seat and fixed bench seat | 113-115 |
| Seat labels | 116 |

Maintenance - Technical data



| | |
|--|---------|
| Checking levels | 278-280 |
| - oil | |
| - brake fluid | |
| - power steering fluid | |
| - coolant | |
| - screenwash, headlamp wash fluid | |
| - additive (Diesel with particle filter) | |
| Checking components | 281-282 |
| - battery | |
| - air / passenger compartment filter | |
| - oil filter | |
| - particle filter | |
| - brake pads / discs | |

| | |
|----------------|---------|
| Changing bulbs | 303-315 |
| - front | |
| - rear | |

| | |
|--------------------------|-----|
| Platform cab | |
| Changing rear lamp bulbs | 315 |
| Dimension | 331 |

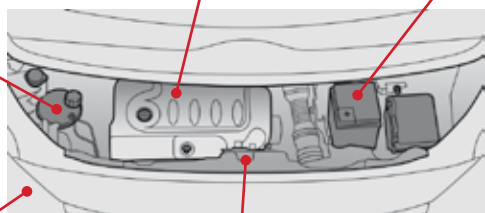
| | |
|------------------------------------|-----|
| Running out of fuel (priming pump) | 327 |
|------------------------------------|-----|



| | |
|---|--------------|
| 12V battery | 321-325 |
|  | |
| Load reduction, economy mode | 270 |
| Engine compartment fuses | 316-317, 320 |
|  | |

| | |
|---------|---------|
| Weights | 332-336 |
|---------|---------|

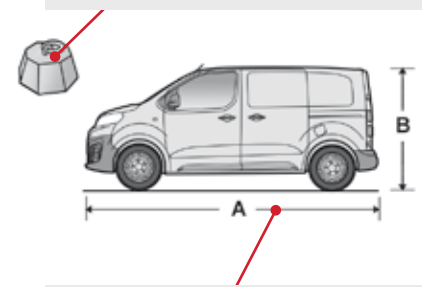

| | |
|-------------------------|---------|
| Dimensions | 328-331 |
| Identification markings | 337 |

| | |
|--------------------|---------|
| Opening the bonnet | 276 |
| Under the bonnet | 277 |
| Engines | 332-336 |
| AdBlue® | 283-286 |

Labels

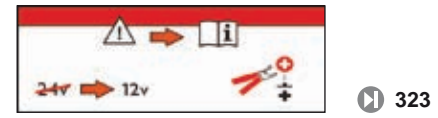
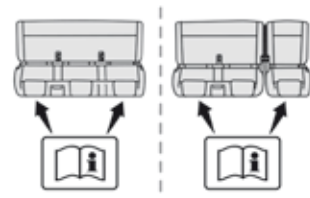
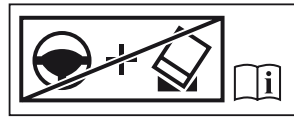

Eco-driving

Eco-driving is a range of everyday practices that allow the motorist to optimise their fuel consumption and CO₂ emissions.

Optimise the use of your gearbox

With a manual gearbox, move off gently and change up without waiting. During acceleration change up early.

With an automatic or electronic gearbox, give preference to automatic mode and avoid pressing the accelerator pedal heavily or suddenly.

The gear shift indicator invites you to engage the most suitable gear: as soon as the indication is displayed in the instrument panel, follow it straight away.

For vehicles fitted with an electronic or automatic gearbox, this indicator appears only in manual mode.

Drive smoothly

Maintain a safe distance between vehicles, use engine braking rather than the brake pedal, and press the accelerator progressively. These practices contribute towards a reduction in fuel consumption and CO₂ emissions and also help to reduce the background traffic noise.

If your vehicle has cruise control, make use of the system at speeds above 25 mph (40 km/h) when the traffic is flowing well.

Control the use of your electrical equipment

Before moving off, if the passenger compartment is too warm, ventilate it by opening the windows and air vents before using the air conditioning. Above 30 mph (50 km/h), close the windows and leave the air vents open.

Remember to make use of equipment that can help keep the temperature in the passenger compartment down (sunroof and window blinds...). Switch off the air conditioning, unless it has automatic regulation, as soon as the desired temperature is attained.

Switch off the demisting and defrosting controls, if not automatic.
Switch off the heated seat as soon as possible.

Switch off the headlamps and front foglamps when the level of light does not require their use.

Avoid running the engine before moving off, particularly in winter; your vehicle will warm up much faster while driving.

As a passenger, if you avoid connecting your multimedia devices (film, music, video game...), you will contribute towards limiting the consumption of electrical energy, and so of fuel. Disconnect your portable devices before leaving the vehicle.

Limit the causes of excess consumption

Spread loads throughout the vehicle; place the heaviest items in the bottom of the boot, as close as possible to the rear seats.

Limit the loads carried in the vehicle and reduce wind resistance (roof bars, roof rack, bicycle carrier, trailer...). Use a roof box in preference. Remove roof bars and roof racks after use.

At the end of winter, remove snow tyres and refit your summer tyres.

Observe the recommendations on maintenance

Check the tyre pressures regularly, when cold, referring to the label in the door aperture, driver's side.

Carry out this check in particular:

- before a long journey,
- at each change of season,
- after a long period out of use.

Don't forget the spare wheel and the tyres on any trailer or caravan.

Have your vehicle serviced regularly (engine oil, oil filter, air filter, passenger compartment filter...) and observe the schedule of operations recommended in the manufacturer's service schedule.

With a BlueHDi Diesel engine, if the SCR system is faulty your vehicle becomes polluting; go to a CITROËN dealer or a qualified workshop without delay to have the emissions of nitrogen oxides brought back to the legal level.

When refuelling, do not continue after the third cut-off of the nozzle to avoid any overflow.

At the wheel of your new vehicle, it is only after the first 1 800 miles (3 000 kilometres) that you will see the fuel consumption settle down to a consistent average.

LCD instrument panel

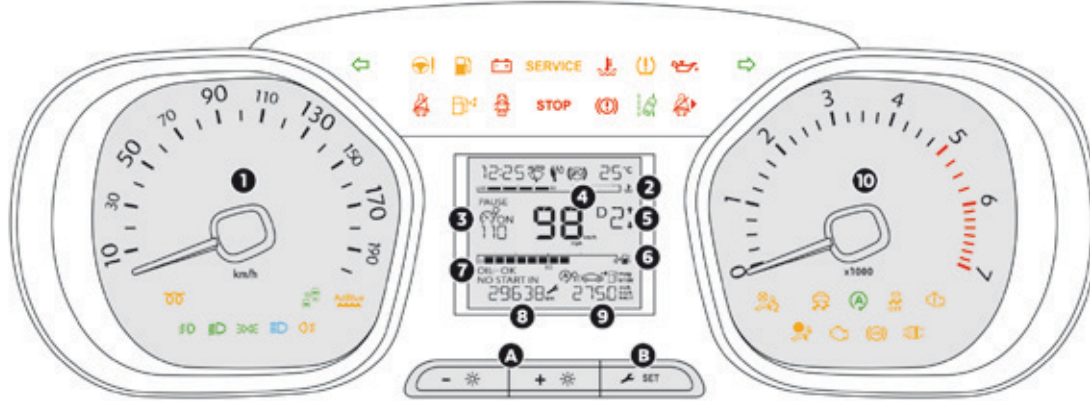

Dials and screens

1. Analogue speedometer (mph or km/h).
2. Engine coolant temperature gauge.
3. Cruise control or speed limiter settings.
4. Digital speedometer (mph or km/h).
5. Gear shift indicator.
Gear with an automatic or electronic gearbox.
6. Fuel gauge.
7. Engine oil level indicator.
8. Service indicator, then total distance recorder (miles or km).
These functions are displayed in turn when the ignition is switched on.
9. Trip recorder (miles or km).
10. Rev counter (x 1 000 rpm or tr/min).

Control buttons

- A. Main lighting dimmer.
- B. Service indicator reset.
If fitted to your vehicle, trip recorder reset.
Date and time adjustment.
Instantaneous information on:
 - servicing,
 - remaining driving range with the emissions control fluid (AdBlue®).

LCD text instrument panel

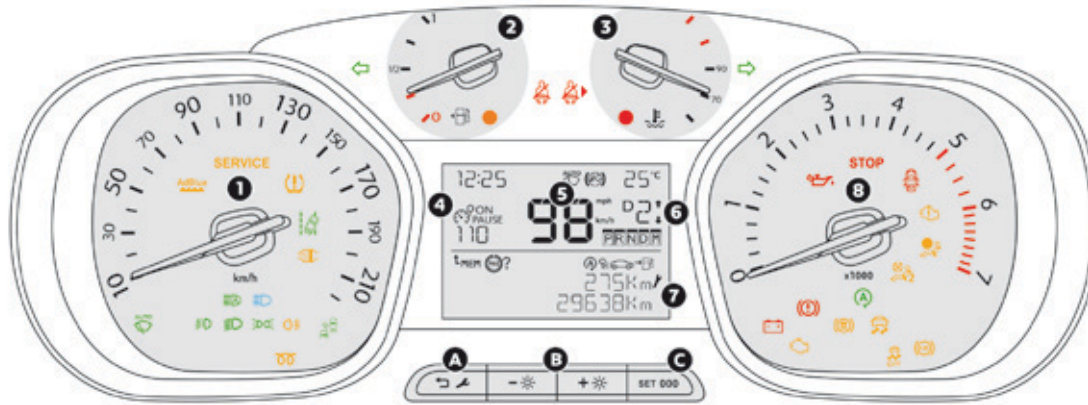

Dials and screens

1. Analogue speedometer (mph or km/h).
2. Fuel gauge.
3. Engine coolant temperature gauge.
4. Cruise control or speed limiter settings.
5. Digital speedometer (mph or km/h).
6. Gear shift indicator.
Gear with an automatic or electronic gearbox.
7. Service indicator, then total distance recorder (miles or km), trip recorder (miles or km), display of messages, ...
8. Rev counter (x 1 000 rpm or tr/min).

Control buttons

- A. Service indicator reset.
Recall of instantaneous information on:
 - servicing,
 - remaining driving range with the emissions fluid (AdBlue®).
- B. Main lighting dimmer.
- C. Trip recorder reset.

Matrix instrument panel

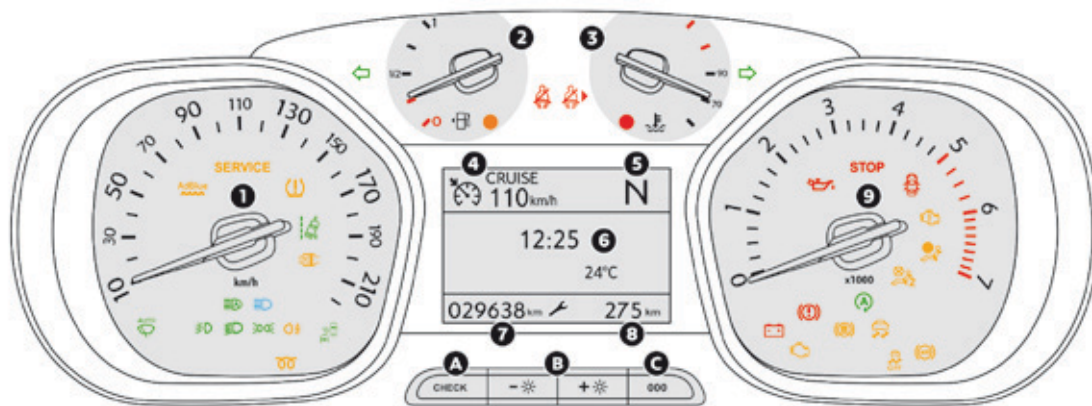

Dials and screens

1. Analogue speedometer (mph or km/h).
2. Fuel gauge.
3. Engine coolant temperature gauge.
4. Cruise control or speed limiter settings.
5. Gear shift indicator.
Gear with an automatic or electronic gearbox.
6. Display area: alert or state of function messages, trip computer, digital speedometer (mph or km/h), ...
7. Service indicator, then total distance recorder (miles or km).
These functions are displayed in turn when the ignition is switched on.
8. Trip recorder (miles or km).
9. Rev counter (x 1 000 rpm or tr/min).

Control buttons

- A. Service indicator reset.
Alert log display.
Recall of information on:
 - servicing,
 - remaining driving range with the emissions fluid (AdBlue®).
- B. Main lighting dimmer.
- C. Trip recorder reset.

Indicator and warning lamps

Visual indicators informing the driver that a system is in operation or is switched off (indicator lamp), or has a fault (warning lamp).

When the ignition is switched on

Certain warning lamps come on for a few seconds when the vehicle's ignition is switched on.

When the engine is started, these same warning lamps should go off.

If they remain on, before moving off, refer to the information on the warning lamp concerned.

Associated warnings

Certain warning lamps may come on in one of two modes: fixed (continuous) or flashing. Only by relating the type of illumination to the operation of the vehicle can it be determined whether the situation is normal or a fault has occurred. In the event of a fault, the illumination of the warning lamp may be accompanied by an audible signal and/or a message.

Warning lamps

When the engine is running or the vehicle is being driven, illumination of one of the following warning lamps indicates a fault which requires action on the part of the driver.

Any fault resulting in the illumination of a warning lamp must be investigated further using the associated message.

If you encounter any problems, contact a CITROËN dealer or a qualified workshop.



Operation indicator lamps

If one of the following indicator lamps comes on in the instrument panel and/or instrument panel screen, this confirms that the corresponding system has come into operation.

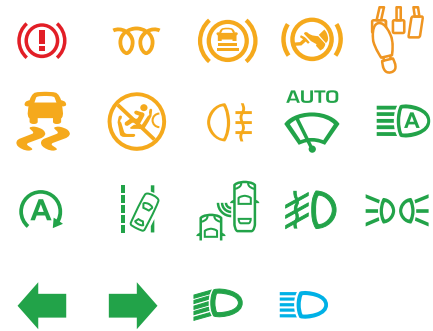











Deactivation indicator lamps

If one of the following indicator lamps comes on, this confirms that the corresponding system has been switched off intentionally.





This may be accompanied by an audible signal and the display of a message.









| Warning / indicator lamp | | State | Cause | Action / Observations |
|---|----------------------|--|--|--|
| STOP | STOP | fixed, associated with another warning lamp, accompanied by an audible signal and a message. | Illumination of this warning lamp is related to a serious fault detected with the engine, the braking system, the power steering, etc., or a major electrical fault. | You must stop as soon as it is safe to do so. Park, switch off the ignition and call a CITROËN dealer or a qualified workshop. |
|  | Parking brake | fixed. | The parking brake is applied or not properly released. | Release the parking brake to switch off the warning lamp, keeping your foot on the brake pedal. Observe the safety recommendations. For more information on the Parking brake , refer to the corresponding section. |
|  | Braking | fixed. | The brake fluid level has dropped significantly. | You must stop as soon as it is safe to do so. Top-up with brake fluid listed by CITROËN. If the problem persists, have the system checked by a CITROËN dealer or a qualified workshop. |
|  +  | | fixed, associated with the ABS warning lamp. | The electronic brake force distribution (EBFD) system has a fault. | You must stop as soon as it is safe to do so. Have it checked by a CITROËN dealer or a qualified workshop. |



| Warning / indicator lamp | | State | Cause | Action / Observations |
|--|---|---|---|--|
|   | Seat belt(s) not fastened / unfastened | fixed or flashing accompanied by an audible signal. | A seat belt has not been fastened or has been unfastened. | Pull the strap then insert the tongue in the buckle. |
|  | Battery charge* | fixed. | The battery charging circuit has a fault (dirty or loose terminals, slack or cut alternator belt, ...). | The warning lamp should go off when the engine is started. If it does not go off, contact a CITROËN dealer or a qualified workshop. |
|  | Engine oil pressure | fixed. | There is a fault with the engine lubrication system. | You must stop as soon it is safe to do so. Park, switch off the ignition and contact a CITROËN dealer or a qualified workshop. |
|  or  | Maximum coolant temperature | fixed with the needle in the red zone. fixed (only with the LCD instrument panel). | The temperature of the cooling system is too high. | Stop as soon as it is safe to do so. Wait until the engine has cooled down before topping-up the level, if necessary. If the problem persists, contact a CITROËN dealer or a qualified workshop. |



* Depending on the country of sale.



| Warning / indicator lamp | State | Cause | Action / Observations |
|---|--|--|---|
|  | <p>Door(s) open</p> <p>fixed, associated with a message identifying the door, if the speed is below 6 mph (10 km/h).</p> <p>fixed, associated with a message identifying the door, together with an audible signal if the speed is above 6 mph (10 km/h).</p> | <p>A front, side or rear door (left-hand side-hinged door or tailgate) is still open.</p> | <p>Close the door in question.</p> <p>If your vehicle has side-hinged rear doors and the right-hand door is still open, it being open will not be signalled by this warning lamp.</p> |
|  <p>or</p>  | <p>Low fuel level</p> <p>fixed, with the needle in the red zone.</p> <p>fixed (only with the LCD instrument panel).</p> | <p>When it first comes on there remains less than 8 litres of fuel in the tank.</p> | <p>You must refuel as soon as possible to avoid running out of fuel.</p> <p>This warning lamp will come on every time the ignition is switched on, until a sufficient addition of fuel is made.</p> <p>Fuel tank capacity : approximately 69 litres.</p> <p>Never continue to drive until you run out of fuel as this could damage the emission control and injection systems.</p> |
|  | <p>Presence of water in the Diesel fuel</p> <p>fixed (only with the LCD instrument panel).</p> | <p>The Diesel fuel filter contains water.</p> | <p>There is a risk of damage to the injection system.</p> <p>Contact a CITROËN dealer or a qualified workshop without delay.</p> |

| Warning / indicator lamp | | State | Cause | Action / Observations |
|--|------------------------------|--|---|---|
|  + STOP | Engine auto-diagnosis system | fixed, associated with the STOP warning lamp. | A major engine fault has been detected. | You must stop as soon as it is safe to do so. Park, switch off the ignition and contact a CITROËN dealer or a qualified workshop. |
|  | Engine auto-diagnosis system | fixed. | The emission control system has a fault. | The warning lamp should go off when the engine is started. If it does not go off, contact a CITROËN dealer or qualified workshop without delay. |
|  | | flashing. | The engine management system has a fault. | Risk of destruction of the catalytic converter. Have it checked by a CITROËN dealer or a qualified workshop. |
| + SERVICE | | fixed, associated with the SERVICE warning lamp. | A minor engine fault has been detected. | Have it checked by a CITROËN dealer or a qualified workshop. |
|  | Diesel engine pre-heating | fixed. | The ignition switch is at the 2 nd position (ignition on). Or The " START/STOP " button has been pressed. | Wait until the warning lamp goes off before starting. Once it goes off, starting is immediate, on condition that: <ul style="list-style-type: none"> - the clutch pedal is pressed fully down with a manual gearbox, - pressure is maintained on the brake pedal with an automatic or electronic gearbox. The period of illumination of the warning lamp is determined by the ambient conditions (up to about thirty seconds in extreme conditions). If the engine does not start, switch the ignition off and then on, wait until the warning lamp goes off again, then start the engine. |

| Warning / indicator lamp | State | Cause | Action / Observations |
|--|--------------------------------|--|--|
|  + SERVICE | Under-inflation | fixed, accompanied by an audible signal and a message. The pressure in one or more tyres is too low. | Check the tyre pressures as soon as possible. This check should preferably be carried out when the tyres are cold. You must reinitialise the system after the adjustment of one or more tyre pressures and after changing one or more wheels. For more information on Under-inflation detection , refer to the corresponding section. |
| | | flashing then fixed, accompanied by the Service warning lamp. | Check the tyre pressures as soon as possible. Have the system checked by a CITROËN dealer or a qualified workshop. |
|  | Foot on the brake pedal | fixed. The brake pedal must be pressed. | With an automatic or electronic gearbox, press the brake pedal, engine running, before releasing the parking brake, to release the selector lever and come out of position P or N . If you wish to release the parking brake without pressing the brake pedal, this warning lamp will remain on. |
|  | Foot on the clutch | fixed. In the STOP mode of Stop & Start, the change to START mode is denied because the clutch pedal is not fully down. | If your vehicle has a manual gearbox, you must declutch fully to allow the change to engine START mode. |

| Warning / indicator lamp | State | Cause | Action / Observations |
|---|---|--|--|
|  Anti-lock Braking System (ABS) | fixed. | The anti-lock braking system has a fault. | The vehicle retains conventional braking. Drive carefully at reduced speed and contact a CITROËN dealer or a qualified workshop without delay. |
|  Collision Risk Alert / Active Safety Brake | flashing. | The system is operating. | The system brakes briefly so as to reduce the speed of collision with the vehicle ahead. |
| | fixed, accompanied by a message and an audible signal | The system has a fault. | Have the system checked by a CITROËN dealer or a qualified workshop. |
| | fixed, accompanied by a message. | The system has been deactivated (via the menu). | For more information on the Collision Risk Alert / Active Safety Brake system, refer to the corresponding section. |
|  Particle filter (Diesel) | fixed, accompanied by an audible signal message on the risk of blockage of the particle filter. | This indicates that the particle filter is starting to become saturated. | As soon as driving conditions allow, regenerate the filter by driving at a speed of at least 35 mph (60 km/h) until the warning lamp goes off. |
| | fixed, accompanied by an audible signal and a message that the particle filter additive level is too low. | This indicates the low level of the additive reservoir. | Have the reservoir topped-up as soon as possible by a CITROËN dealer or a qualified workshop. |

| Warning / indicator lamp | State | Cause | Action / Observations |
|--|--|---|---|
|  Airbags | on temporarily. | This warning lamp comes on for a few seconds when you turn on the ignition, then goes off. | This warning lamp should go off when the engine is started. If it does not go off, contact a CITROËN dealer or a qualified workshop. |
| | fixed. | One of the airbag or seat belt pretensioner systems has a fault. | Have them checked by a CITROËN dealer or a qualified workshop. |
|  Passenger's front airbag | fixed in the seat belt and front passenger's airbag warning lamps display. | <p>The control switch, located at the passenger's end of the dashboard, is set to the "OFF" position.</p> <p>The passenger's front airbag is deactivated.</p> <p>You can install a rearward facing child seat, unless there is a fault with the airbags (airbag warning lamp on).</p> | Turn the control switch to the "ON" position to activate the passenger's front airbag; in this case, you must not install a child seat in the rearward facing position on this seat. |
|  Passenger's airbag system | fixed. | <p>The control switch, located at the passenger's end of the dashboard, is at the "ON" position.</p> <p>The passenger's front airbag is activated.</p> <p>In this case, do not install a rearward facing child seat on the front passenger seat.</p> | Turn the control switch to the "OFF" position to deactivate the passenger's front airbag. You can install a rearward facing child seat, unless there is a fault with the airbags (airbag warning lamp on). |



| Warning / indicator lamp | State | Cause | Action / Observations |
|---|-----------|---|---|
|  <p>Dynamic stability control (DSC/ASR)</p> | fixed. | <p>The button is pressed and the indicator lamp comes on. The DSC/ASR is deactivated. DSC: dynamic stability control. ASR: anti-slip regulation.</p> | <p>Press the button to activate the DSC/ASR. Its indicator lamp goes off. The DSC/ASR system is activated automatically when the vehicle is started. If deactivated, the system is reactivated automatically from around 30 mph (50 km/h). For more information on the Electronic stability programme (ESC) and in particular, DSC/ASR, refer to the corresponding section.</p> |
|  <p>Dynamic stability control (DSC/ASR)</p> | flashing. | The DSC/ASR regulation is operating. | The system optimises traction and improves the directional stability of the vehicle in the event of loss of grip or trajectory. |
| | fixed. | The DSC/ASR system has a fault. | Have the system checked by a CITROËN dealer or a qualified workshop. |
|  <p>Power steering</p> | fixed. | The power steering has a fault. | <p>Drive carefully at reduced speed. Have it checked by a CITROËN dealer or a qualified workshop.</p> |





| Warning / indicator lamp | | State | Cause | Action / Observations |
|---|-------------------------------------|---|--|---|
|  | AdBlue® (BlueHDi Diesel) | fixed, on switching on the ignition, accompanied by an audible signal and a message indicating the remaining driving range. | The remaining driving range is between 350 miles (600 km) and 1500 miles (2400 km). | Have the AdBlue® tank topped-up as soon as possible: go to a CITROËN dealer or a qualified workshop, or carry out this operation yourself. |
| | | flashing, accompanied by an audible signal and a message indicating the remaining driving range. | The remaining driving range is between 0 and 350 miles (600 km). | You must top-up the AdBlue® tank to avoid a breakdown : go to a CITROËN dealer or a qualified workshop, or carry out this operation yourself. |
| | | flashing, accompanied by an audible signal and a message indicating that starting is prevented. | The AdBlue® tank is empty: the starting inhibition system required by legislation prevents starting of the engine. | To be able to start the engine, you must top-up the AdBlue® tank : go to a CITROËN dealer or a qualified workshop, or carry out this operation yourself. It is essential to add at least 3.8 litres of AdBlue® to the fluid tank. |









For topping-up the AdBlue® fluid or for more information on **AdBlue®**, refer to the corresponding section.

| Warning / indicator lamp | State | Cause | Action / Observations |
|--|--|---|--|
|  <p>SCR emissions control system (BlueHDi Diesel)</p> | <p>fixed, on switching on the ignition, associated with the SERVICE and engine diagnostic warning lamps, accompanied by an audible signal and a message.</p> | <p>A fault with the SCR emissions control system has been detected.</p> | <p>This alert disappears once the exhaust emissions return to normal levels.</p> |
| | <p>flashing, on switching on the ignition, associated with the SERVICE and engine diagnostic warning lamps, accompanied by an audible signal and a message indicating the remaining driving range.</p> | <p>After confirmation of the fault with the emissions control system, you can drive for up to 650 miles (1 100 km) before the engine starting inhibition system is triggered.</p> | <p>Contact a CITROËN dealer or a qualified workshop without delay, to avoid a breakdown.</p> |
| | <p>flashing, on switching on the ignition, associated with the SERVICE and engine diagnostic warning lamps, accompanied by an audible signal and a message.</p> | <p>You have exceeded the authorised driving limit following confirmation of a fault with the emissions control system: the engine starting inhibition system prevents starting of the engine.</p> | <p>To be able to start the engine, you must call on a CITROËN dealer or a qualified workshop.</p> |

| Warning / indicator lamp | | State | Cause | Action / Observations |
|---|----------------------|--|---|---|
| SERVICE  | Service | on temporarily. | A minor fault has occurred for which there is no specific warning lamp. | Identify the fault by means of the associated message, for example: <ul style="list-style-type: none"> - low engine oil level, - low screenwash/headlamp wash fluid level, - discharged remote control battery, - low tyre pressures, - saturation of the particle filter (FAP) on Diesel vehicles. - ... For more information on Checks and in particular the particle filter, refer to the corresponding section. For any other faults, contact a CITROËN dealer or a qualified workshop. |
| | | fixed. | A major fault has occurred for which there is no specific warning lamp. | Identify the fault by reading the message and contact a CITROËN dealer or a qualified workshop. |
| | | fixed, associated with flashing and then fixed display of the service spanner. | The servicing interval has been exceeded. | Only on BlueHDi Diesel versions. Your vehicle must be serviced as soon as possible. |
|  | Rear foglamps | fixed. | The rear foglamps are on. | Turn the ring on the stalk rearward to switch off the rear foglamps. |

| Warning / indicator lamp | | State | Cause | Action / Observations |
|---|--------------------------------------|---|---|--|
|  | Automatic wiper | fixed. | The wiper control has been pushed down. | Automatic front wiping is activated. To deactivate automatic wiping, operate the control stalk downwards or put the stalk into another position. |
|  | Automatic headlamp dipping | fixed. | The lighting control stalk is in the "AUTO" position, and the function has been activated. The main beam headlamps come on if the exterior lighting and driving conditions permit. | The camera, located at the top of the windscreen, manages the operation of main beam, depending on the ambient lighting and driving conditions. For more information on Automatic headlamp dipping , refer to the corresponding section. |
|  | Stop & Start | fixed. | When the vehicle stops (red lights, traffic jams, ...) the Stop & Start system has put the engine into STOP mode. | The warning lamp goes off and the engine restarts automatically in START mode, as soon as you want to move off. |
| | | flashes for a few seconds, then goes off. | STOP mode is temporarily unavailable, or START mode is invoked automatically. | For more information on Stop & Start , refer to the corresponding section. |
|  | Lane departure warning system | fixed. | The lane departure warning system has been activated. | The lane departure warning system is on. For more information on the Lane departure warning system , refer to the corresponding section. |
|  | Blind spot monitoring system | fixed. | The blind spot monitoring system has been activated. | For more information on the Blind spot monitoring system , refer to the corresponding section. |

| Warning / indicator lamp | | State | Cause | Action / Observations |
|---|---------------------------------------|-----------------------|--|---|
|  | Front foglamps | fixed. | The front foglamps are switched on using the ring on the lighting control stalk. | Turn the ring on the lighting control stalk rearward once to switch off the front foglamps. |
|  | Sidelamps | fixed. | The lighting stalk is in the "Sidelamps" position. | |
|  | Left-hand direction indicator | flashing with buzzer. | The lighting stalk has been pushed down. | |
|  | Right-hand direction indicator | flashing with buzzer. | The lighting stalk has been pushed up. | |
|  | Dipped beam headlamps | fixed. | The lighting stalk is in the "Dipped beam headlamps" position. | |
|  | Main beam headlamps | fixed. | The lighting stalk has been pulled towards you. | Pull the stalk to return to dipped beam headlamps. |

i For more information on the **Lighting control stalk**, refer to the corresponding section.

Engine coolant temperature

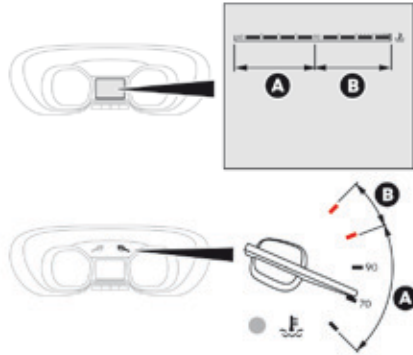

With the engine running, when the needle or the bar graph (depending on version) is:

- in zone **A**, the temperature of the engine coolant is correct,
- in zone **B**, the temperature of the engine coolant is too high; the maximum temperature and the central **STOP** warning lamps come on, accompanied by an audible signal and a warning message in the touch screen.

You MUST stop as soon as it is safe to do so.

Wait a few minutes before switching off the engine.

Contact a CITROËN dealer or a qualified workshop.

Checking the level

After driving for a few minutes, the temperature and pressure in the cooling system increase.

To top up the level:

- ☞ wait at least one hour for the engine to cool,
- ☞ unscrew the cap two turns to allow the pressure to drop,
- ☞ when the pressure has dropped, remove the cap,
- ☞ top up the level to the "MAX" mark.



Be aware of the risk of burns when topping up the cooling system. Do not fill above the maximum level (indicated on the header tank).

Service indicator

System which informs the driver when the next service is due, in accordance with the manufacturer's servicing schedule.

The point at which the next service is due is calculated from the last indicator zero reset, depending on the distance travelled and the time elapsed since the last service.

For BlueHDi Diesel versions, the degree of deterioration of the engine oil is also taken into account (depending on the country of sale).



More than 1 800 miles (3 000 km) remain before the next service is due

When the ignition is switched on, no service information appears in the screen.

Between 600 miles (1 000 km) and 1 800 miles (3 000 km) remain before the next service is due

For 5 seconds after the ignition is switched on, the spanner symbolising the service operations comes on. The distance recorder display line indicates the distance remaining before the next service is due.

Example: 1 700 miles (2 800 km) remain before the next service is due.

For 5 seconds after the ignition is switched on, the screen indicates:

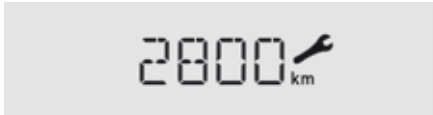

5 seconds after the ignition is switched on, **the spanner goes off**; the distance recorder resumes its normal operation. The screen then indicates the total distance.

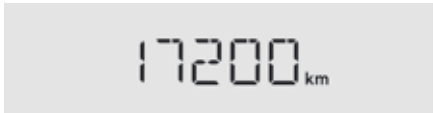

Less than 600 miles (1 000 km) remain before the next service is due

Example: 560 miles (900 km) remain before the next service is due.

For 5 seconds after the ignition is switched on, the screen indicates:



5 seconds after the ignition is switched on, the distance recorder resumes its normal operation. **The spanner remains on** to indicate that a service must be carried out soon.

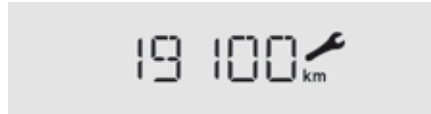

Service overdue

For 5 seconds after the ignition is switched on, **the spanner flashes** to indicate that the service must be carried out as soon as possible.

Example: the service is overdue by 180 miles (300 km).

For 5 seconds after the ignition is switched on, the screen indicates:



5 seconds after the ignition is switched on, the distance recorder resumes its normal operation. **The spanner remains on.**

For BlueHDi Diesel versions, this alert may also be accompanied by the fixed illumination of the service warning lamp when the ignition is on.

The distance remaining may be weighted by the time factor, depending on the driving conditions. Therefore, the spanner may also come on if you have exceeded the period since the last service, indicated in the manufacturer's service schedule. For BlueHDi Diesel versions, the spanner may also be brought on earlier than expected, depending on the degree of deterioration of the engine oil (depending on the country of sale). The rate of deterioration of the engine oil depends on the driving conditions in which the vehicle is used.

Resetting the service indicator

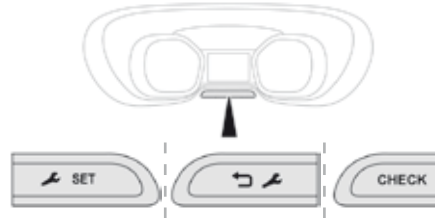

After each service, the service indicator must be reset to zero. If you have carried out the service on your vehicle yourself, switch off the ignition:



☞ Press and hold this button,

- ☞ Switch on the ignition; the distance recorder display begins a countdown,
- ☞ When the display indicates "**=0**", release the button; the spanner disappears.

If you have to disconnect the battery following this operation, lock the vehicle and wait at least five minutes for the reset to be registered.

Retrieving the service information

You can access the service information at any time.



☞ Press this button.

The service information is displayed for a few seconds, then disappears.

Engine oil level indicator

On versions fitted with an electric oil gauge, information on the oil level is displayed in the instrument panel for a few seconds when the ignition is switched on, at the same time as the service information.

- The level read will only be correct if the vehicle is on level ground and the engine has been off for more than 30 minutes.

Oil level correct



This is indicated by a message in the instrument panel.

Oil level incorrect

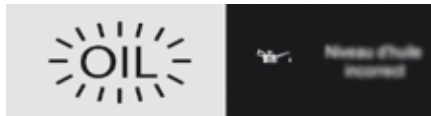

This is indicated by a message in the instrument panel.

If the low oil level is confirmed by a check using the dipstick, the level must be topped-up to avoid damage to the engine.

Oil level indicator fault



This is indicated by a message in the instrument panel. Contact a CITROËN dealer or a qualified workshop.

Dipstick

- To locate the dipstick and the oil filler cap for the **Diesel engine**, refer to the corresponding section.



There are 2 marks on the dipstick:

- **A** = max; never exceed this level,
- **B** = min; top-up the level via the oil filler, using the grade of oil suited to your engine.

AdBlue® fluid range indicators

Once the AdBlue® tank is on reserve or after detection of a fault with the SCR emissions control system, when the ignition is switched on, an indicator displays an estimate of the distance that can be covered, the range, before engine starting is prevented.

In the event of simultaneous system fault and low AdBlue® level, the shortest range figure is the one displayed.



The engine start prevention system required by regulations is activated automatically once the AdBlue® tank is empty.

In the event of the risk of non-starting related to a lack of AdBlue®

Remaining range greater than 1 500 miles (2 400 km)

When switching on the ignition, there is no automatic display of range in the instrument panel.



Pressing this button will display the remaining range.

You can access this information in the touch screen, if your vehicle has one.



Select the **"Driving"** menu.

Select **"OPTIONS"**.



Then select **"Diagnostic"**.



The range is then displayed temporarily.

Above 3 000 miles (5 000 km), the value is not specified.

Remaining range between 350 and 1500 miles (600 and 2 400 km)



When switching on the ignition, this warning lamp comes on, accompanied by an audible signal and the display of a message (e.g.: "Top up emissions additive: Starting prevented in 900 miles") indicating the remaining range expressed in miles or kilometres.



If your vehicle has an LCD instrument panel, "NO START IN" is displayed.

When driving, the message is displayed every 200 miles (300 km) until the fluid has been topped-up.

Go to a CITROËN dealer or a qualified workshop to have the AdBlue® topped-up. You can also top-up the tank yourself.



For more information on **AdBlue® and the SCR system**, and in particular on topping-up the AdBlue®, refer to the corresponding section.

Remaining range between 0 and 350 miles (0 and 600 km)



When switching on the ignition, this warning lamp flashes, accompanied by an audible signal and the display of a message (e.g. "Top up emissions additive: Starting prevented in 350 miles") indicating the remaining range expressed in miles or kilometres.



If your vehicle has an LCD instrument panel, "NO START IN" is displayed.

When driving, the message is displayed every 30 seconds until the fluid has been topped-up. Go to a CITROËN dealer or a qualified workshop to have the AdBlue® topped-up. You can also top-up the tank yourself. Otherwise you will not be able to restart your engine.

i For more information on **AdBlue® and the SCR system**, and in particular on topping-up the AdBlue®, refer to the corresponding section.

Breakdown related to a lack of AdBlue®



When switching on the ignition, this warning lamp flashes, accompanied by an audible signal and the display of the message "Top up emissions additive: Starting prevented".

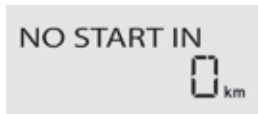

If your vehicle has an LCD instrument panel, "NO START IN" is displayed.

The AdBlue® tank is empty: the system required by regulations prevents engine starting.

! To be able to start the engine, we recommend that you call on a CITROËN dealer or a qualified workshop for the top-up required. If you carry out the top-up yourself, it is essential to add at least 3.8 litres of AdBlue® to the tank.

In the event of a fault with the SCR emissions control system

! A system that prevents engine starting is activated automatically from 650 miles (1 100 km) after confirmation of a fault with the SCR emissions control system. Have the system checked by a CITROËN dealer or a qualified workshop as soon as possible.

In the event of the detection of a fault



These warning lamps come on, accompanied by an audible signal and the display of the message "Emissions fault". The alert is triggered when driving when the fault is detected for the first time, then when switching on the ignition for subsequent journeys, while the fault persists.

i If it is a temporary fault, the alert disappears during the next journey, after self-diagnosis of the SCR system.

During an authorised driving phase (between 650 miles and 0 miles) (1 100 km and 0 km)



If a fault with the SCR system is confirmed (after 30 miles (50 km) covered with the permanent display of the message signalling a fault), these warning lamps come on, accompanied by an audible signal and the display of a message (e.g.: "Emissions fault: Starting prevented in 150 miles") indicating the remaining range expressed in miles or kilometres.



If your vehicle has an LCD instrument panel, "NO START IN" is displayed.

While driving, the message is displayed every 30 seconds while the fault with the SCR system persists. The alert is repeated when switching on the ignition. You should go to a CITROËN dealer or a qualified workshop as soon as possible. Otherwise, you will not be able to restart your engine.

Starting prevented



Every time the ignition is switched on, these warning lamps come on, accompanied by an audible signal and the display of the message "Emissions fault: Starting prevented".

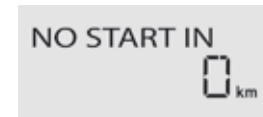

If your vehicle has an LCD instrument panel, "NO START IN" is displayed.

! You have exceeded the authorised driving limit: the starting prevention system inhibits engine starting.

To be able to start the engine, you must call on a CITROËN dealer or a qualified workshop.

Distance recorders

The total and trip distances are displayed for thirty seconds when the ignition is switched off, when the driver's door is opened and when the vehicle is locked or unlocked.

i When travelling abroad, you may have to change the units of distance: the display of road speed must be in the official units (miles or km) for the country. The change of units is done via the screen configuration menu, with the vehicle stationary.



Total distance recorder

It measures the total distance travelled by the vehicle since its first registration.



Trip distance recorder

It measures the distance travelled since it was reset to zero by the driver.



With the ignition on, press this button until zeros appear.



Lighting dimmer

This system allows the brightness of the instruments and controls to be adjusted to suit the ambient light level.

At the instrument panel

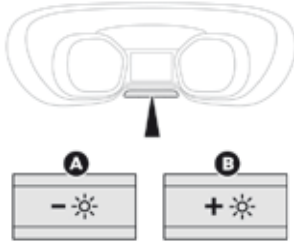

- ☞ With the exterior lighting on, press this button to raise the level of brightness.
 - ☞ With the exterior lighting on, press this button to lower the level of brightness.
- As soon as the lighting reaches the required level of brightness, release the button.

With the touch screen

- ☞ Press on the **Settings** button.
- ☞ Select "**OPTIONS**".
- ☞ Select "**Screen configuration**".
- ☞ Select the "**Brightness**" tab.
- ☞ Adjust the brightness by moving the cursor.
- ☞ Press on "**Confirm**" to save and quit.

You can also switch off the screen. To do this:

- ☞ Press on the **Settings** button.
- ☞ Select **Switch off screen**.

The screen goes off completely. Press on the screen again (anywhere on its surface) to activate it.

Trip computer

System that gives you information on the current journey (range, fuel consumption...).



Display of information

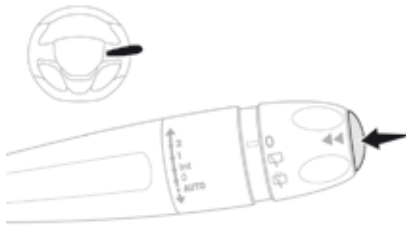

☞ Press the button on the end of the **wiper control stalk** to display the different trip computer tabs in turn.

☞ Or, depending on equipment, press the thumbwheel on the **steering wheel**.

- The current information with:
 - the range,
 - the current fuel consumption,
 - the Stop & Start time counter.

1

- Trip "1" with:
 - the average speed,
 - the average fuel consumption,
 - the distance travelled, for the first trip.

Depending on equipment, a 2nd trip is available.

2

- Trip "2" with:
 - the average speed,
 - the average fuel consumption,
 - the distance travelled, for the second trip.

Trips "1" and "2" are independent but their use is identical.

For example, trip "1" can be used for daily figures, and trip "2" for monthly figures.

Trip reset

With LCD instrument panel

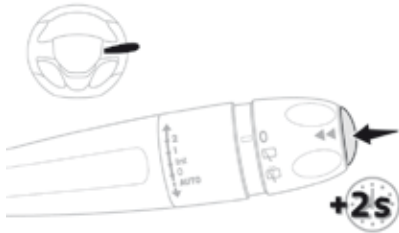

- ☞ When the trip is displayed, press the button on the end of the **wiper control stalk** for two seconds.

With LCD text or matrix instrument panel

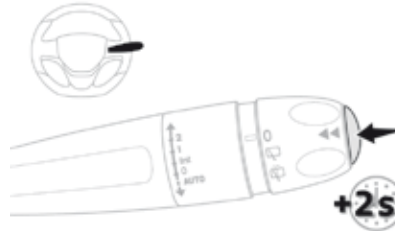

- ☞ When the trip is displayed, press the button on the end of the **wiper control stalk**.

With LCD text instrument panel

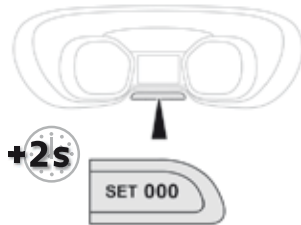

- ☞ When the desired trip is displayed, press the reset button in the instrument panel for more than two seconds.



- ☞ Or, depending on equipment, press the thumbwheel on the **steering wheel** for more than two seconds.

A few definitions



Range

(miles or km)

The distance which can still be travelled with the fuel remaining in the tank (related to the average fuel consumption over the last few miles (kilometres) travelled).



This value may vary following a change in the style of driving or the relief, resulting in a significant change in the current fuel consumption.

When the range falls below 20 miles (30 km), dashes are displayed. After filling with at least 8 litres of fuel, the range is recalculated and is displayed when it exceeds 60 miles (100 km).



If dashes are displayed continuously while driving in place of the digits, contact a CITROËN dealer or a qualified workshop.



Current fuel consumption

(mpg or l/100 km or km/l)

Calculated over the last few seconds.



This function is only displayed from 20 mph (30 km/h).



Average fuel consumption

(mpg or l/100 km or km/l)

Calculated since the last trip reset.



Average speed

(mph or km/h)

Calculated since the last trip reset.



Distance travelled

(miles or km)

Calculated since the last trip reset.



Stop & Start time counter

(minutes / seconds or hours / minutes)

If your vehicle is fitted with Stop & Start, a time counter calculates the time spent in STOP mode during a journey.

It resets to zero every time the ignition is switched on.

Touch screen

Use the buttons on either side of the touch screen for access to the menus, then press the virtual buttons in the touch screen.

✓ Use this button to confirm.

✗ Use this button to quit.

! As a safety measure, the driver must only carry out operations requiring sustained attention with the vehicle stationary.

Menus



Driving.

Allows certain functions to be switched on and off and their settings adjusted.



Settings.

Allows configuration of the display and the system.



Radio Media.



Connectivity.



Connected navigation.



Telephone.



Adjust volume/Mute.
On/Off.













For more information on the touch screen, refer to the **Audio and telematics** section.

Driving menu

The systems with settings that can be adjusted are detailed in the table below.

For more information on a driving assistance system refer to the corresponding section.

| Button | Corresponding function | Comments |
|--|---------------------------------------|---|
|  | Under-inflation initialisation | Reinitialisation of the under-inflation system. |
|  | Blind spot monitoring system | Activation/Deactivation of the function. |
|  | Stop & Start system | Activation/Deactivation of the function. |
|  or  | Lane departure warning system | Activation/Deactivation of the function. |
|  | Automatic headlamp dip | Activation/Deactivation of the function. |

| Button | Corresponding function | Comments |
|---|--|---|
|  | <p>Vehicle settings To deactivate/activate a function, press OFF/ON. To modify a setting (lighting duration, ...) or find additional information, press the symbol for the function.</p> | <p>Access to other functions with settings that can be adjusted. Select or deselect the tabs at the bottom of the touch screen to sort the display of the desired functions.</p> <ul style="list-style-type: none"> - Lighting: <ul style="list-style-type: none"> - "Directional headlamps": activation/deactivation of the directional headlamps. - "Guide-me-home lighting": activation/deactivation of the automatic guide-me-home lighting. - "Welcome lighting": activation/deactivation of the exterior welcome lighting. - "Mood lighting": activation/deactivation of the interior mood lighting. - Access: <ul style="list-style-type: none"> - "Hands-Free Access": activation/deactivation of the motorized opening and closing of a side door by the hands-free system, - "Locks your vehicle after the motorized closing of a side door, using hands-free access.": activation/deactivation of the locking of your vehicle after the motorized closing of a side door by the hands-free system. - Assistance (driving aids): <ul style="list-style-type: none"> - "Rear wiper in reverse": activation/deactivation of the operation of the rear wiper in reverse. - "Recommended speed display": activation/deactivation of the speed limit recognition system, allowing a speed setting to be given to the cruise control or speed limiter. - "Collision risk alert and automatic braking": activation/deactivation of collision risk alerts. - "Fatigue Detection System": activation/deactivation of the driver fatigue detection system. |
|  | <p>Diagnostic</p> | <p>List of current alerts.</p> |
|  | <p>Parking sensors</p> | <p>Activation/Deactivation of the function.</p> |
|  | <p>Adjust speed settings</p> | <p>Memorisation of speed settings for the speed limiter or active cruise control.</p> |

Setting the time and date

Without audio system

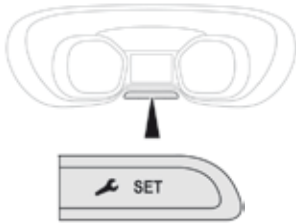

- ☞ Press this button to display the following settings in turn:
 - hours,
 - minutes,
 - 12 or 24 hour format.

With the audio system



- ☞ Press the **MENU** button for access to the **main menu**.



- ☞ Press the "◀" or "▶" button to select the **Personalisation-configuration** menu, then confirm by pressing the **"OK"** button.
- ☞ Press the "▲" or "▼" button to select the **Display configuration** menu then confirm by pressing the **"OK"** button.
- ☞ Press the "▲" or "▼" and "◀" or "▶" buttons to set the date and time, then confirm by pressing the **"OK"** button.

With the touch screen



- ☞ Press on **Settings** for access to the different menus.

- ☞ Select **"OPTIONS"**.

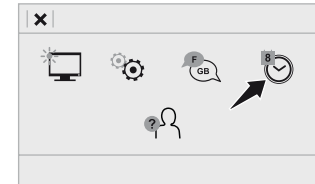

- ☞ Select **"Setting the time-date"**.

- ☞ Select the **"Date"** or **"Time"** tab.
- ☞ Modify the settings in the associated **"Date"** or **"Time"** fields then press on **"Confirm"**.



- ☞ Press on **"Confirm"** to save and quit.



You can choose to synchronise the time and date with the GPS navigation system (if fitted to your vehicle) so that these settings are adjusted automatically.

Key

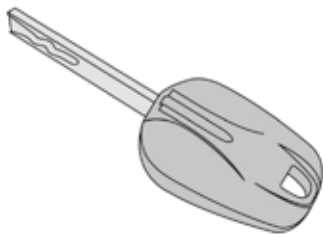

The key allows the central locking or unlocking of the vehicle using the door lock. It also allows the fuel filler cap to be removed and refitted and the engine started or switched off.

Key, remote control

It allows the central locking or unlocking of the vehicle using the door lock or from a distance. It also allows the vehicle to be located, the fuel filler cap to be removed and refitted and the engine to be started or switched off, as well as providing protection against theft.

i The remote control buttons are not active when the ignition is switched on.

Unfolding / Folding the key

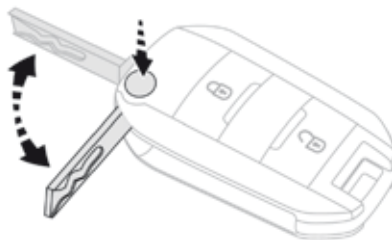

e Press this button to unfold or fold the key.

! If you do not press the button, you risk damaging the remote control.



What is the point of total or selective unlocking?



Total unlocking allows **all** of the vehicle's doors (front, side and rear) to be unlocked.



Selective unlocking allows either the **cab** doors, or the **loading area** doors (side and rear) to be unlocked.

i This separation of **cab** and **loading area** locking provides security in use. It allows you to prevent access to the part of the vehicle where you are not present.

Programming



- To activate this selectivity between **cab** and **loading area**, switch the ignition on and press this button for more than 2 seconds.

Its indicator lamp comes on.



- To deactivate this selectivity and return to **total** unlocking, switch the ignition on and press this button for more than 2 seconds.

Its indicator lamp goes off.

The modification is confirmed by an audible signal and, depending on equipment, the display of a message.

i By default, selectivity between **cab** and **loading area** is activated.



Total unlocking



Cab and **loading area** selectivity deactivated.

Using the key



- To **totally** unlock the vehicle, turn the key towards the front of the vehicle.
 - Then to open the door, pull the handle.
- If your vehicle has an alarm, this is not deactivated. Opening a door will trigger the alarm, which can then be stopped by switching the ignition on.

Using the remote control



- Press one of these buttons (depending on equipment) to unlock the vehicle.



If fitted to your vehicle, pressing and holding this button allows the windows to be opened. The window stops when you release the button.



Using the remote control with electric sliding side door(s)



- To **totally** unlock the vehicle without opening the side door, press this button.



- To **totally** unlock the vehicle and open the side door, press and hold this button until the door has opened.



Unlocking is signalled by the rapid flashing of the direction indicators for about two seconds. Depending on version, the door mirrors unfold at the same time.

Selective unlocking



Cab and loading area selectivity activated.

Using the remote control



To unlock the **cab** doors only, make an initial press on this button.



To unlock the **loading area** doors (side and rear), press this button again

i

If fitted to your vehicle, pressing and holding this button opens the windows. The window stops when you release the button.



If fitted to your vehicle:



To unlock the **loading area** only, press this button.

Using the remote control with electric sliding side door(s)



Press this button to unlock the **loading area** only, without opening the side door.



Press this button to unlock the **loading area** only and open the side door, press and hold this button until the door has opened.

i

Unlocking is confirmed by rapid flashing of the direction indicators for about two seconds. Depending on version, the electric door mirrors unfold at the same time.

Unlocking



Using the key

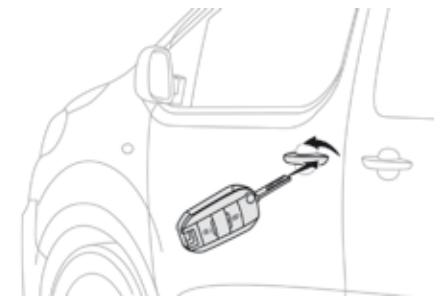

To unlock the vehicle, turn the key to the front of the vehicle.

Then pull the handle to open the door.

If your vehicle has an alarm, this is not deactivated. Opening a door will trigger the alarm, which can then be stopped by switching the ignition on.

2

Using the remote control



To unlock the vehicle, press this button.

Using the remote control with electric sliding side door(s)



To unlock the vehicle and open the side door, press and hold this button until the door has opened.

i Unlocking is signalled by the rapid flashing of the direction indicators for about two seconds. Depending on version, the door mirrors unfold at the same time.

Locking

Using the key

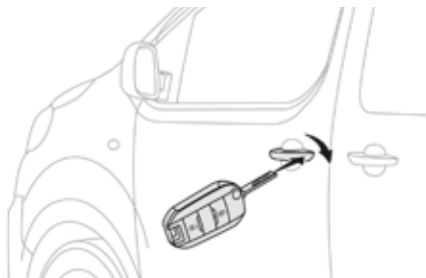

To unlock the vehicle totally, turn the key to the rear of the vehicle.

If your vehicle has an alarm, this will not be activated.

Using the remote control



To lock the vehicle **totally**, press this button.

i If fitted to your vehicle, pressing and holding this button closes the windows. The window stops when you release the button.



! Ensure that no person or object might prevent the correct closing of the windows. Be particularly aware of children when operating the windows.



If a door is not fully closed (except the right-hand door with side-hinged doors):

- vehicle stationary and the engine running, this warning lamp comes on, accompanied by an alert message for a few seconds,
- vehicle moving (speed above 6 mph (10 km/h)), this warning lamp comes on, accompanied by an audible signal and an alert message for a few seconds.

! Driving with the doors locked may render access for the emergency services difficult in an emergency. As a safety measure (children on board), never leave the vehicle without taking your remote control, even for a short period.

i If your vehicle is not fitted with an alarm, locking is confirmed by the fixed illumination of the direction indicators for about two seconds. According to version, the door mirrors fold at the same time.

i If one of the openings (doors or boot) is still open, the central locking does not take place. When the vehicle is locked, if it is unlocked inadvertently, it will lock itself again automatically after about thirty seconds unless a door is opened. And if your vehicle has an alarm, this will be reactivated (with volumetric monitoring, even if this had been deactivated). The folding and unfolding of the door mirrors by the remote control can be deactivated by a CITROËN dealer or a qualified workshop.

Deadlocking

! Deadlocking renders the exterior and interior door controls inoperative. It also deactivates the manual central control button. Therefore, never leave anyone inside the vehicle when it is deadlocked.

Using the key

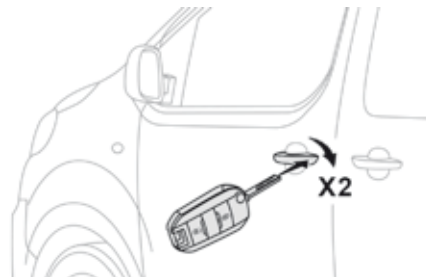

To deadlock the vehicle:

- ☞ Turn the key to the rear of the vehicle.
- ☞ Then **within five seconds**, turn the key to the rear again.

Using the remote control

To lock the vehicle:



- ☞ Press this button.



Depending on version, the door mirrors fold at the same time.

To deadlock the vehicle:



- ☞ Then **within five seconds after locking**, press this button again.



If your vehicle is not fitted with an alarm, deadlocking is signalled by the fixed illumination of the direction indicators for about two seconds.

i

If fitted to your vehicle, pressing and holding this button allows the windows to be closed. The window stops when you release the button.



!

Ensure that no person or object could prevent the correct closing of the windows.

Be particularly aware of children when operating the windows.

Locating your vehicle

This function allows you to identify your vehicle from a distance, particularly in poor light. Your vehicle must have been locked for more than five seconds.



☞ Press this button

This switches on the courtesy lamps and the direction indicators flash for about ten seconds.

Remote operation of lighting

If fitted to your vehicle.



A short press on this button switches on the lighting remotely (sidelamps, dipped beam headlamps and number plate lamps).



A second press on this button before the end of the timed period cancels the remote lighting.

Anti-theft protection

Electronic engine immobiliser

The remote control contains an electronic chip which has a special code. When the ignition is switched on, this code must be recognised in order for starting to be possible.

This electronic engine immobiliser locks the engine management system a few moments after the ignition is switched off and prevents starting of the engine by anyone who does not have the key.

SERVICE In the event of a fault, you are informed by illumination of this warning lamp, an audible signal and a message in the screen.

In this case, your vehicle will not start; contact a CITROËN dealer as soon as possible.

i

Keep safely, away from your vehicle, the label attached to the keys given to you on acquisition of the vehicle.

Back-up control(s)

For mechanically locking and unlocking the doors in the event of a fault with the central locking system or a battery failure.

Locking the driver's door

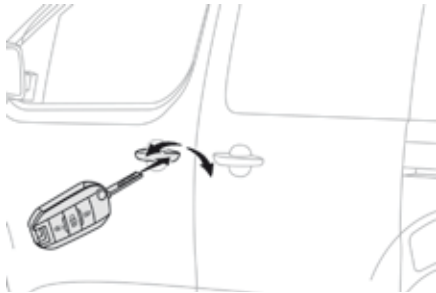

- ☞ Insert the key in the door lock and turn it to the rear.

Unlocking

- ☞ Insert the key in the door lock and turn it to the front.

i If your vehicle has an alarm, it will not be deactivated/activated on unlocking/locking the vehicle. Opening a door will trigger the alarm, which can be stopped by switching on the ignition.

Locking the front passenger door

- ☞ Open the door.

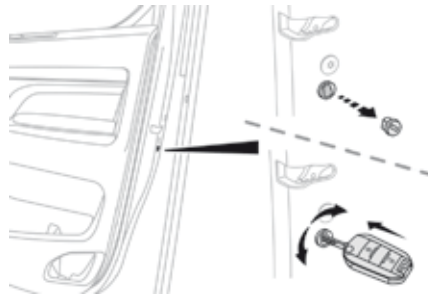

- ☞ Remove the cap on the edge of the door.
- ☞ Insert the key into the latch aperture (without forcing) and turn the assembly.
- ☞ Remove the key and refit the cap.
- ☞ Close the door and check from the outside that it has locked correctly.

Unlocking

Use the interior door handle.

Locking the sliding side door

- ☞ If fitted to your vehicle, check that the electric child lock is not on.
- ☞ Open the door.

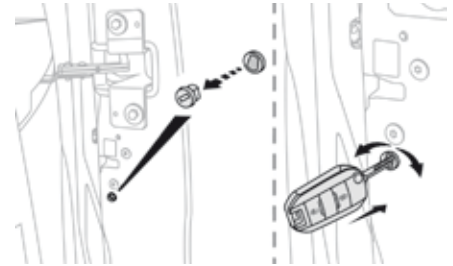

- ☞ Remove the cap on the edge of the door.
- ☞ Insert the key into the latch aperture (without forcing) and turn the assembly.
- ☞ Remove the key and refit the cap.
- ☞ Close the door and check from the outside that it has locked correctly.

Unlocking

- ☞ Use the interior door handle.

i For more information on the **Child lock**, refer to the corresponding section.

Locking the side-hinged doors

- ☞ If fitted to your vehicle, check that the electric child lock is not on.
- ☞ Open the left-hand door.

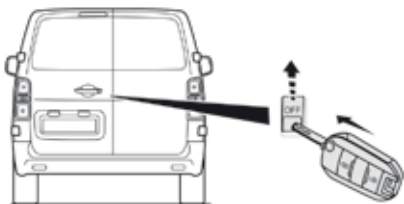

- ☞ Insert the key into the latch aperture on the edge of the door (without forcing) and slide the assembly upward.
- ☞ Remove the key.
- ☞ Close the door and check from the outside that it has locked correctly.

Unlocking

- ☞ Use the interior door handle.

Remote control problem

Following disconnection of the vehicle battery, replacement of the remote control battery or in the event of a remote control malfunction, you can no longer unlock, lock or locate your vehicle.

- ☞ First of all, use the key in the lock to unlock or lock your vehicle.
- ☞ Then reinitialise the remote control.

If the problem persists, contact a CITROËN dealer as soon as possible.

Reinitialisation



- ☞ Lock the driver's door using the key.
- ☞ Press one of the remote control buttons.

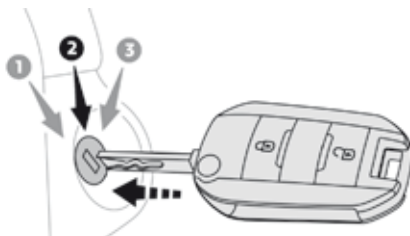

- ☞ Turn the key to position **2 (Ignition on)**.
- ☞ Switch off the ignition and remove the key from the ignition switch.

The remote control is fully operational again.

Changing the battery

Battery ref.: CR1620 / 3 volts.

SERVICE If the battery is flat, you are informed by lighting of this warning lamp in the instrument panel, an audible signal and a message in the screen.

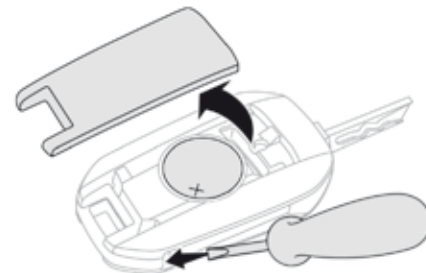

- ☞ Unclip the cover using a screwdriver in the cut-out.
- ☞ Remove the cover.
- ☞ Extract the flat battery from its location.
- ☞ Place the new battery into its location observing the original direction.
- ☞ Clip the cover in place.



Do not throw the remote control batteries away, they contain metals which are harmful to the environment. Take them to an approved collection point.

"Keyless Entry and Starting"

Remote control

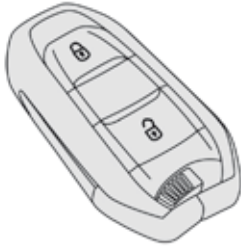

It allows the central locking or unlocking of the vehicle from a distance. It is also used to locate and start the vehicle, as well as providing protection against theft.



What is the point of total or selective unlocking?



Total unlocking allows **all** of the vehicle's doors (front, side and rear) to be unlocked.



Selective unlocking allows either the **cab** doors, or the **loading area** doors (side and rear) to be unlocked.

i This separation of **cab** and **loading area** locking provide security in use. It allows you to prevent access to the part of the vehicle where you are not present.

Programming



- To activate this selectivity between **cab** and **loading area**, switch the ignition on and press this button for more than 2 seconds.

Its indicator lamp comes on.



- To deactivate this selectivity and return to **total** unlocking, switch the ignition on and press this button for more than 2 seconds.

Its indicator lamp goes off.

The modification is confirmed by an audible signal and, depending on equipment, the display of a message.

i By default, selectivity between **cab** and **loading area** is activated.



Total unlocking



Cab and loading area selectivity deactivated.



☞ Press one of these buttons (depending on equipment) to unlock the vehicle.



i

If fitted to your vehicle, pressing and holding this button allows the windows to be opened. The window stops when you release the button.



With electric sliding side door(s)



☞ To **totally** unlock the vehicle without opening the side door, press this button.



☞ To **totally** unlock the vehicle and open the side door, press and hold this button until the door has opened.



i

Unlocking is signalled by the rapid flashing of the direction indicators for about two seconds. Depending on version, the door mirrors unfold at the same time.



Selective unlocking



Cab and loading area selectivity activated.



☞ To unlock only the **cab doors**, make an initial press on this button.



☞ To unlock the **loading area** doors (side and rear), press on this button again.

i

If fitted to your vehicle, pressing and holding this button allows the windows to be opened. The window stops when you release the button.



If fitted to your vehicle:



☞ Press on this button to unlock the **loading area** only.

With electric sliding side door(s)



To unlock the **loading area** only without opening the side door, press on this button.



To unlock the **loading area** only and open the side door, press and hold this button until the door has opened.

i Unlocking is signalled by the rapid flashing of the direction indicators for about two seconds. Depending on version, the door mirrors unfold at the same time.



Unlocking



To unlock the vehicle, press this button.



With electric sliding door(s)

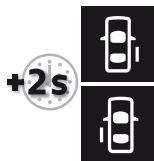

To unlock the vehicle and open the side door, press and hold this button until the door has opened.

i Unlocking is signalled by the rapid flashing of the direction indicators for about two seconds. Depending on version, the door mirrors unfold at the same time.

Locking



To **totally** lock the vehicle, press this button.



If fitted to your vehicle, pressing and holding this button allows the windows to be closed. The window stops when you release the button.



Ensure that no person or object could prevent the correct closing of the windows.

Be particularly aware of children when operating the windows.



If a door is not correctly shut (except the right-hand door with side-hinged rear doors):

- vehicle stationary and the engine running, this warning lamp comes on, accompanied by an alert message for a few seconds,
- vehicle moving (speed above 6 mph (10 km/h)), this warning lamp comes on, accompanied by an audible signal and an alert message for a few seconds.

! Driving with the doors locked may make access to the passenger compartment by the emergency services more difficult in the event of an emergency. As a safety measure (children on board), never leave the vehicle without your remote control, even for a short period.

i If your vehicle is not fitted with an alarm, locking is signalled by the fixed illumination of the direction indicators for about two seconds. Depending on version, the door mirrors fold at the same time.

i If one of the doors remains open, the central locking does not take place. If the vehicle is inadvertently unlocked, it will automatically lock itself again after about thirty seconds, if no door is opened. And if fitted to your vehicle, the alarm is reactivated (with volumetric monitoring, even if you had deactivated it).

i The automatic folding and unfolding of the electric door mirrors can be deactivated by a CITROËN dealer or a qualified workshop.

Deadlocking

! Deadlocking renders the exterior and interior door controls inoperative. It also deactivates the manual central control button. Therefore, never leave anyone inside the vehicle when it is deadlocked.

To lock the vehicle:



☞ Press this button.

i Depending on version, the door mirrors fold at the same time.

To deadlock the vehicle:



☞ Then **within five seconds after locking**, press this button again.

i If your vehicle is not fitted with an alarm, deadlocking is signalled by the fixed illumination of the direction indicators for about two seconds.

i If fitted to your vehicle, pressing and holding this button allows the windows to be closed. The window stops when you release the button.



! Ensure that no person or object could prevent the correct closing of the windows. Be particularly aware of children when operating the windows.

"Keyless Entry and Starting" on your person

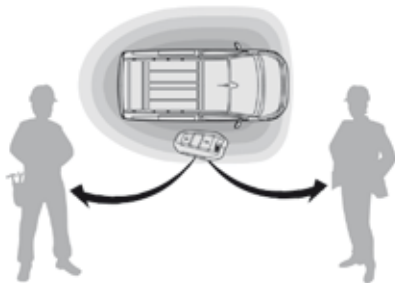

This allows the unlocking, locking and starting the vehicle while keeping the remote control on your person.

i In the ignition on (accessories) position, with the "START/STOP" button, the hands-free function is deactivated. For more information on "**Keyless Entry and Starting**" and in particular the "ignition on" position, refer to the corresponding section.

i The unlocking, locking or deadlocking does not take place:

- if the ignition is on,
- if one of the doors or the boot is still open,
- if the key for the Keyless Entry and Starting system has been left inside the vehicle.

When the vehicle is locked (with the remote control or Keyless Entry and Starting), if it is unlocked inadvertently, it will lock itself again automatically after about thirty seconds unless a door has been opened.

And if your vehicle has an alarm, this will be reactivated (with volumetric monitoring, even if this had been deactivated).

i The folding and unfolding of the door mirrors by the remote control can be deactivated by a CITROËN dealer or a qualified workshop.

! As a safety measure (children on board), never leave the vehicle without taking your Keyless Entry and Starting remote control, even for a short period. Guard against theft when the Keyless Entry and Starting remote control is in the recognition zone with the vehicle unlocked. In order to preserve the charge of the cell battery in the remote control, the "hands-free" functions go into extended stand-by after 21 days of non-use. To restore these functions, press one of the remote control buttons or start the engine with the remote control at the reader.



Total unlocking



Cab and loading area selectivity deactivated.

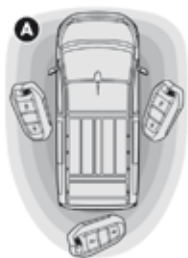

- ☞ To unlock the **vehicle**, remote control on your person and in the recognition zone **A**, pass your hand behind one of the door handles (front doors, manual sliding side doors or side-hinged doors).
- ☞ Pull the handle to open the corresponding door.

With electric sliding side door(s)

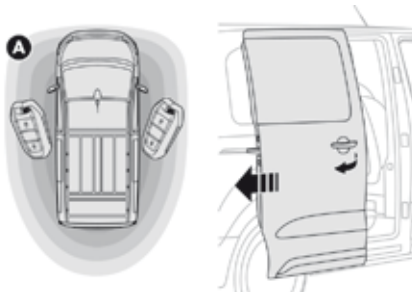

- ☞ To unlock the **vehicle**, remote control on your person and in the recognition zone **A**, pull and release the door handle. This action also triggers the electrically powered opening of the corresponding door.

With tailgate

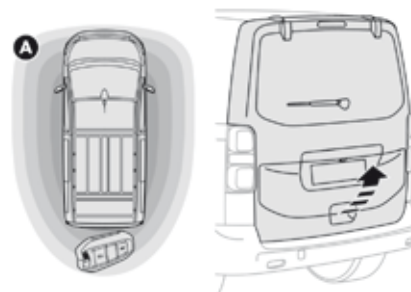

- ☞ To unlock the **vehicle**, remote control on your person and in the recognition zone **A**, pull the tailgate handle.
- ☞ Raise the tailgate.

i Unlocking is signalled by the rapid flashing of the direction indicators for about two seconds.
Depending on version, the door mirrors unfold and the alarm is deactivated.

Selective unlocking



Cab and loading area selectivity activated.

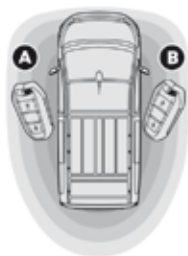

- ☞ To unlock the **cab** only, remote control on your person in the recognition zone **A** or **B**, pass your hand behind one of the front door handles.
- ☞ Pull the handle to open the corresponding door.

i The state of the locks for the **loading area** doors remains unchanged.

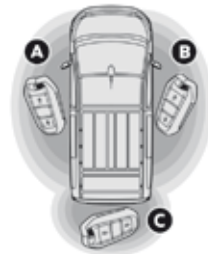

- ☞ To unlock the **loading area** only, remote control on your person and in the recognition zone **A**, **B** or **C**, pass your hand behind the door handle on one of the doors, left, right or rear.
- ☞ Pull on the handle to open the corresponding door.

i Depending on version, the door mirrors unfold only on unlocking the cab, the alarm is deactivated

With electric sliding slide door(s)

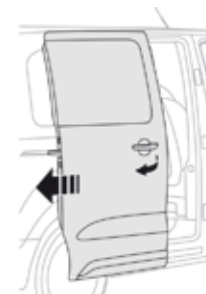
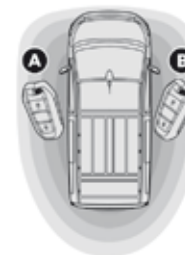

- ☞ To unlock the **loading area**, remote control on your person and in the recognition zone **A** and **B**, pull and release the door handle. This action also triggers the electrically powered opening of the corresponding door.

2

With tailgate

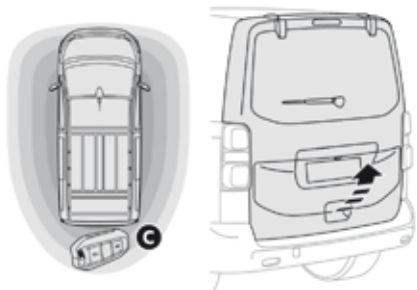

- ☞ To unlock the **loading area** only, remote control on your person and in the recognition zone **C**, pull the tailgate handle.
- ☞ Raise the tailgate.

i Unlocking is signalled by the rapid flashing of the direction indicators for about two seconds.

Unlocking

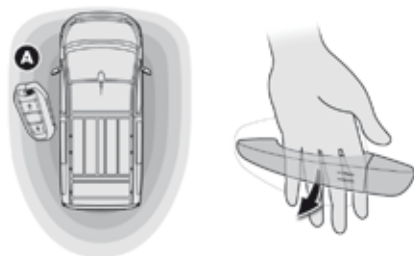

- ☞ To unlock the vehicle, remote control on your person and in the recognition zone **A**, pass your hand behind one of the door handles (front doors, manual sliding side doors and side-hinged doors).
- ☞ Pull the handle to open the corresponding door.

With electric sliding side door(s)

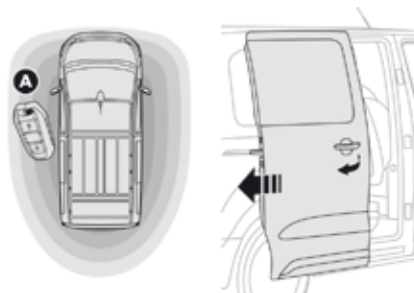

- ☞ To unlock the vehicle, remote control on your person and in the recognition zone **A**, pull and release the door handle to trigger the electric powered opening of the corresponding door.

With tailgate

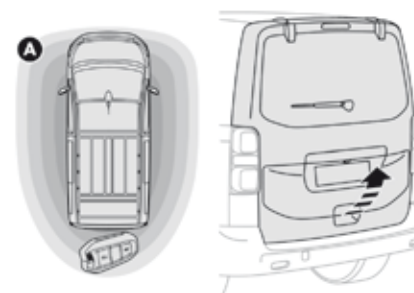

- ☞ To unlock the vehicle, remote control on your person and in the recognition zone **A**, pull the tailgate handle.
- ☞ Raise the tailgate.

i Unlocking is signalled by the rapid flashing of the direction indicators for about two seconds. Depending on version, the door mirrors unfold, the alarm is deactivated.

Locking

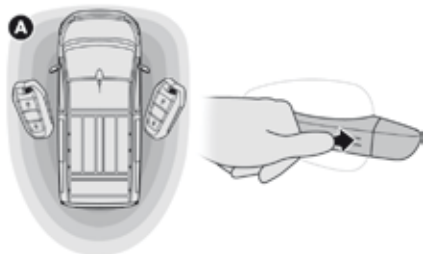

- ☞ To **totally** lock the vehicle, with the remote control in the recognition zone **A**, press with a finger or thumb at the markings on one of the front or manual sliding side door handles.

With electric sliding side door(s)

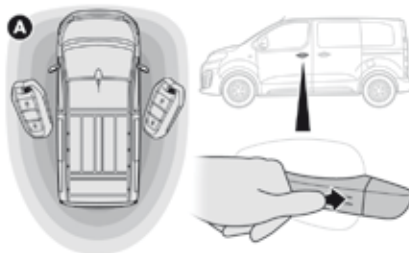

- ☞ To **totally** lock the vehicle, with the remote control in the recognition zone **A**, press with a finger or thumb at the markings on one of the **front** door handles.

With side-hinged doors

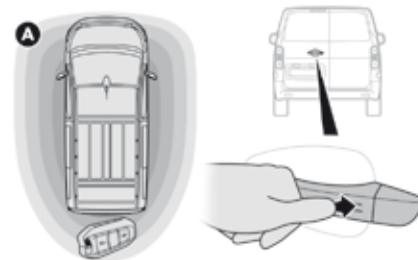

- ☞ To lock the vehicle, with the remote control in the recognition zone **A**, press the left-hand door locking control.



If a door is not properly closed (except the right-hand door with side-hinged rear doors):

- vehicle stationary and the engine running, this warning lamp comes on, accompanied by an alert message for a few seconds,
- vehicle moving (speed above 6 mph (10 km/h)), this warning lamp comes on, accompanied by an audible signal and an alert message for a few seconds.

With a tailgate

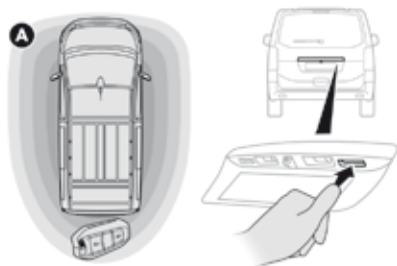

- To lock the vehicle, with the remote control in the recognition zone **A**, press the tailgate locking control.

i If fitted to your vehicle, pressing and holding the locking controls allows the windows to be opened. The window stops when you release the button.

+3s

- Ensure that no one might prevent the correct operation of the windows. Be particularly aware of children when operating the windows.

i If your vehicle is not fitted with an alarm, locking is confirmed by fixed illumination of the direction indicators for about two seconds. Depending on version, the door mirrors fold at the same time.

- Driving with the doors locked may render access for the emergency services difficult in an emergency.

Deadlocking

- Deadlocking renders the exterior and interior door controls inoperative. It also deactivates the manual central locking button. Therefore, never leave anyone inside the vehicle when it is deadlocked.

2

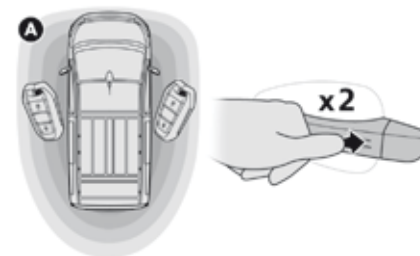

- To **totally** lock the vehicle, with the remote control in the recognition zone **A**, press with a finger or thumb at the markings on one of the front or manual sliding side door handles.
- To deadlock the vehicle, press the marking again **within five seconds**.

With electric sliding side door(s)

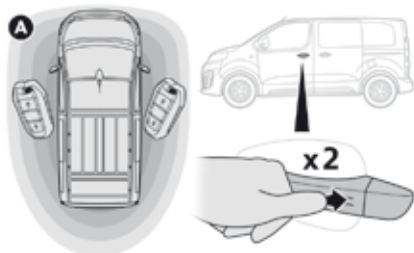

- ☞ To **totally** lock the vehicle, with the remote control in the recognition zone **A**, press with a finger or thumb at the markings on one of the **front** door handles.
- ☞ To deadlock the vehicle, press the marking again **within five seconds**.

With side-hinged doors

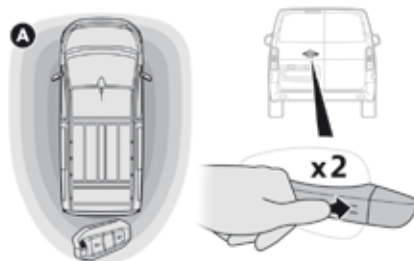

- ☞ To lock the vehicle, with the remote control in the recognition zone **A**, press the left-hand door locking control.
- ☞ To deadlock the vehicle, press the control again **within five seconds**.

With a tailgate



- ☞ To lock the vehicle, with the remote control in the recognition zone **A**, press the tailgate locking control.
- ☞ To deadlock the vehicle, press the control again **within five seconds**.

i If your vehicle is not fitted with an alarm, deadlocking is confirmed by fixed illumination of the direction indicators for about two seconds.

Locating your vehicle

This function allows you to identify your vehicle from a distance, particularly in poor light. Your vehicle must have been locked for more than five seconds.



☞ Press this button

This switches on the courtesy lamps and the direction indicators flash for about ten seconds.

Remote operation of lighting

If fitted to your vehicle.



A short press on this button switches on the lighting remotely (sidelamps, dipped beam headlamps and number plate lamps).



A second press on this button before the end of the timed period cancels the remote lighting.

Anti-theft protection

Electronic engine immobiliser

The remote control contains an electronic chip which has a special code. When the ignition is switched on, this code must be recognised in order for starting to be possible.

This electronic engine immobiliser locks the engine management system a few moments after the ignition is switched off and prevents starting of the engine by anyone who does not have the key.

SERVICE In the event of a fault, you are informed by illumination of this warning lamp, an audible signal and a message in the screen.

In this case, your vehicle will not start; contact a CITROËN dealer as soon as possible.



Keep safely, away from your vehicle, the label attached to the keys given to you on acquisition of the vehicle.

Back-up control(s)

Integral key

It is used to lock and unlock the vehicle when the remote control cannot operate:

- cell battery flat, vehicle battery discharged or disconnected, ...
- vehicle located in an area with strong electromagnetic signals.

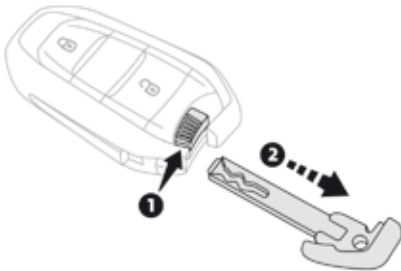

- ☞ Press and hold button **1** to extract the integral key **2**.

i If the alarm is activated, the audible signal triggered on opening a door with the key (integral with the remote control) will stop when the ignition is switched on.

Locking the driver's door



- ☞ Insert the integral key into the door lock, then turn it to the rear.

Unlocking

- ☞ Insert the integral key into the door lock, then turn it to the front.

i If your vehicle has an alarm, it will not be deactivated/activated on unlocking/locking the vehicle. Opening a door will trigger the alarm, which can be stopped by switching the ignition on. To deadlock the vehicle, turn the key again within five seconds of locking.

Locking the front passenger door

- ☞ Open the door.

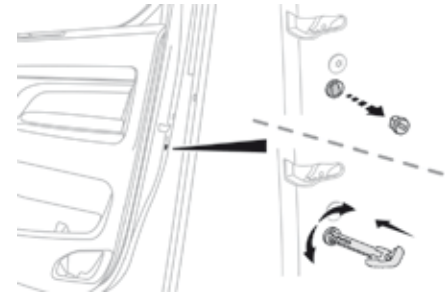

- ☞ Remove the cap on on the edge of the door.
- ☞ Insert the key into the latch aperture (without forcing) and turn the assembly.
- ☞ Remove the key and refit the cap.
- ☞ Close the door and check from the outside that the vehicle has locked correctly.

Unlocking

- ☞ Use the interior door handle.

Locking a sliding side door

- ☞ If fitted to your vehicle, check that the electric child lock is not on.
- ☞ Open the door.

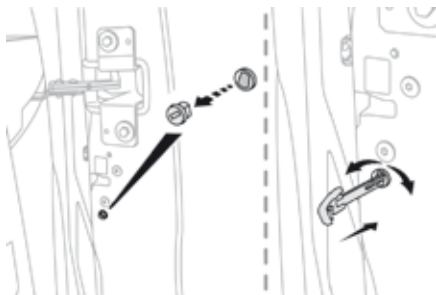

- ☞ Remove the cap on the edge of the door.
- ☞ Insert the key into the latch aperture (without forcing) and turn the assembly.
- ☞ Remove the key and refit the cap.
- ☞ Close the door and check from the outside that the vehicle has locked correctly.

Unlocking

- ☞ Use the interior door handle.

Locking the side-hinged doors

- ☞ If fitted to your vehicle, check that the electric child lock is not on.
- ☞ Open the left-hand side-hinged door.

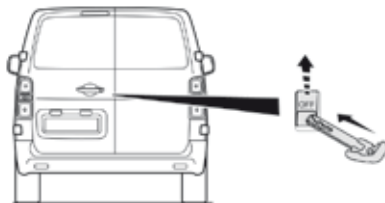

- ☞ Insert the key (without forcing) into the latch aperture located on the edge of the door and slide the assembly upward.
- ☞ Remove the key.
- ☞ Close the door and check from the outside that the vehicle has locked correctly.

Unlocking

- ☞ Use the interior door handle.

i For more information on the **child lock**, refer to the corresponding section.

Remote control problem

Following disconnection of the vehicle battery, replacement of the remote control battery or in the event of a remote control malfunction, you can no longer unlock, lock or locate your vehicle.

- ☞ First, use the integral key in the door lock to unlock or lock your vehicle.
- ☞ Then, reinitialise the remote control.

Reinitialisation

- ☞ Unlock the driver's door using the integral key.



- ☞ Press one of the remote control buttons.

- ☞ Place the integral key in the lock to unlock your vehicle.



- ☞ Place the remote control against the reader.
- ☞ Keeping it in place, switch on the ignition by pressing "START/STOP".

The remote control is fully operational again.

i If the problem persists, contact a CITROËN dealer or a qualified workshop as soon as possible.

Changing the battery

Battery ref.: CR2032 / 3 volts.

This replacement battery is available from a CITROËN dealer or a qualified workshop. A message appears in the instrument panel screen when replacement of the battery is needed.

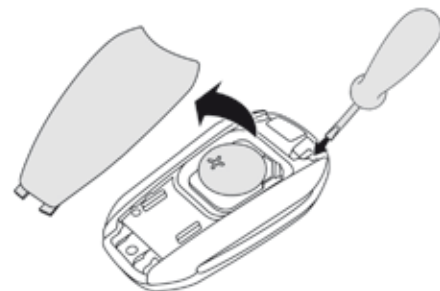

- ☞ Unclip the cover using a small screwdriver at the cutout.
- ☞ Lift off the cover.
- ☞ Remove the flat battery from its location.
- ☞ Fit the new battery into its location observing the original direction of fitment.
- ☞ Clip the cover onto the casing.



Do not throw the remote control batteries away, they contain metals which are harmful to the environment. Take them to an approved collection point.

! Lost keys, remote control

Visit a CITROËN dealer with the vehicle's registration certificate, your personal identification documents and if possible, the label bearing the key code.

The CITROËN dealer will be able to retrieve the key code and the transponder code required to order a new key.

Remote control

The high frequency remote control is a sensitive system; do not operate it while it is in your pocket as there is a possibility that it may unlock the vehicle, without you being aware of it.

Do not repeatedly press the buttons of your remote control out of range and out of sight of your vehicle. You run the risk of stopping it from working and the remote control would have to be reinitialised.

The remote control does not operate when the key is in the ignition, even when the ignition is switched off.

Locking the vehicle

Driving with the doors locked may make access to the passenger compartment by the emergency services more difficult in an emergency.

As a safety precaution (with children on board), remove the key from the ignition or take the remote control with you when leaving the vehicle, even for a short time.

Electrical interference

The Keyless Entry and Starting remote control may not operate if close to certain electronic devices: telephone, laptop computer, strong magnetic fields, ...

Anti-theft protection

Do not make any modifications to the electronic engine immobiliser system; this could cause malfunctions.

Do not forget to turn the steering to engage the steering lock.

When purchasing a second-hand vehicle

Have the key codes memorised by a CITROËN dealer, to ensure that the keys in your possession are the only ones which can start the vehicle.

! Accumulations (water, dust, grime, salt...) on the inner surface of the door handle may affect detection. If cleaning the inner surface of the door handle using a cloth does not restore detection, contact a CITROËN dealer or a qualified workshop. A sudden splash of water (stream of water, high pressure jet washer, ...) may be identified by the system as the desire to open the vehicle.

Locking / unlocking from inside

Locking the vehicle



- i** This button is inoperative if the vehicle has been locked or deadlocked from outside (using the key, remote control or Keyless Entry and Starting, according to equipment) or if one of the doors is still open.

Automatic

The cabin doors lock automatically while driving (speed above 6 mph (10 km/h)); the indicator lamp comes on.



- ☞** To activate or deactivate this function, with the ignition on, press this button until a message appears in the screen.



Manual



- ☞** Press this button.

The indicator lamp comes on to confirm the locking.

- i** When carrying long objects with the tailgate or rear doors open, you can press this button to lock just the cabin doors.
When locking from inside, the door mirrors do not fold.

- !** Driving with the doors locked may make access to the passenger compartment by the emergency services more difficult in an emergency.

- !** If the vehicle is deadlocked or locked with the remote control or the door handles, the button is not active. In this case, use the key or the remote control to unlock.

Unlocking the vehicle



- ☞** Press this button.

The indicator lamp goes off to confirm the unlocking.

- i** The indicator lamp also goes off when unlocking one or more doors.



Locking / unlocking the loading area

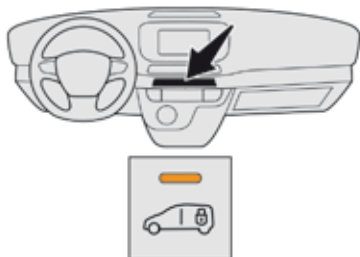

- i** This button is inoperative if the vehicle has been locked or deadlocked from outside (using the key, remote control or Keyless Entry and Starting, depending on equipment) or if one of the doors is still open.

Automatic

The **loading area** doors always lock while driving.

- i** To deactivate this automatic locking, go to a CITROËN dealer or a qualified workshop.

Manual



Cab and loading area selectivity deactivated.



- ☞** Vehicle unlocked, press this button.

The indicator lamp comes on to confirm the locking of the **vehicle**.



- ☞** Vehicle locked, press this button.

The indicator lamp goes off to confirm the unlocking of the **vehicle**.



Cab and loading area selectivity activated.



- ☞** **Loading area** unlocked, press this button.

The indicator lamp comes on to confirm the locking of the **loading area**.



- ☞** **Loading area** locked, press this button.

The indicator lamp goes off to confirm the unlocking of the **loading area**.

- !** Driving with the doors locked may make access to the passenger compartment by the emergency services more difficult in an emergency.

- i** The indicator lamp goes off when one or more of the **loading area** doors is unlocked.
To save energy, with the ignition off and the vehicle totally locked, the indicator lamp goes off.

- i** For more information on the **Key, Remote control** or **Keyless Entry and Starting**, and in particular, programming the selective locking of the loading area, refer to the corresponding section.

Front doors

Opening

From outside



- ☞ After unlocking the vehicle (using the key, remote control or Keyless Entry and Starting, depending on equipment), pull the door handle.

i For more information on the **Key, Remote control** or **Keyless Entry and Starting** and in particular unlocking the vehicle, refer to the corresponding section.

From inside



Cab and loading area selectivity deactivated and the vehicle locked.

- ☞ Pull the interior control lever of a door to **totally** unlock the vehicle and open the door.



Cab and loading area selectivity activated and the vehicle locked.

- ☞ Pull the interior control lever of a door to unlock the **cab** and open the door.



Vehicle locked.

- ☞ Pull the interior control lever on a door to **totally** unlock the vehicle and open the door.

i If the door is unlocked, pull the handle to open the door.

! The interior door controls do not operate when the vehicle is deadlocked.

Closing

- ☞ Push or pull the door to close it, then lock it.



When a door is not fully closed:

- vehicle stationary and engine running, this warning lamp comes on, accompanied by an alert message for a few seconds,
- vehicle moving (speed above 6 mph (10 km/h)), this warning lamp comes on, accompanied by an audible signal and an alert message for a few seconds.

i For more information on the **Key, Remote control or Keyless Entry and Starting** and in particular locking the vehicle, refer to the corresponding section.

Manual sliding side door(s)

From outside



- ☞ After unlocking the vehicle (using the key, remote control or Keyless Entry and Starting, depending on equipment) pull the door handle.

i For more information on the **Key, Remote control or Keyless Entry and Starting** and in particular unlocking the vehicle, refer to the corresponding section.

i To hold the sliding side door in the open position, open the door fully to engage the latch (located at the bottom of the door).

! Take care not to block the guide space on the floor to allow the door to slide correctly.
As a safety measure and for functional reasons, do not drive with the sliding side door open.

From inside

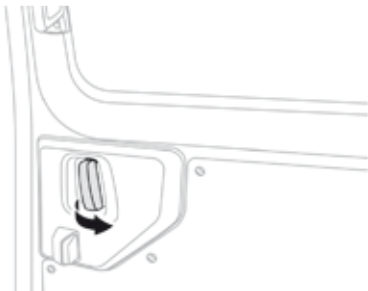

Vehicle locked



Cab and loading area selectivity deactivated.

- ☞ Pull the interior opening control of a door to **totally** unlock the vehicle and open the door.



Cab and loading area selectivity deactivated and child lock off (deactivated).

- ☞ Pull the interior opening control of a door to **totally** unlock the vehicle and open the door.



Cab and loading area selectivity activated.

- ☞ Pull the interior opening control of a door to unlock the **loading area** and open the door.



Cab and loading area selectivity activated and child lock off (deactivated).

- ☞ Pull the interior opening control of a door to unlock the **loading area** and open the door.



- ☞ Pull the interior opening control of a door to **totally** unlock the vehicle and open the door.

Vehicle unlocked



- ☞ Pull the handle towards the rear to open the door.



Child lock off (deactivated).

- ☞ Pull the handle towards the rear to open the door.

i For more information on the **Child lock**, refer to the corresponding section.

Closing

From outside

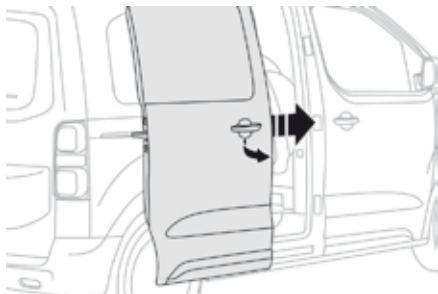

- ☞ Pull the handle toward you, then to the front, and if necessary lock the vehicle.

From inside

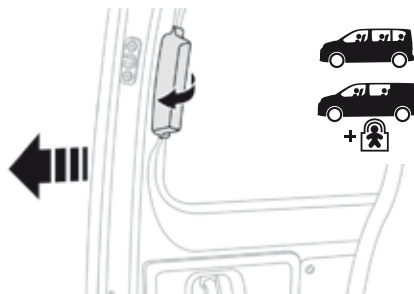
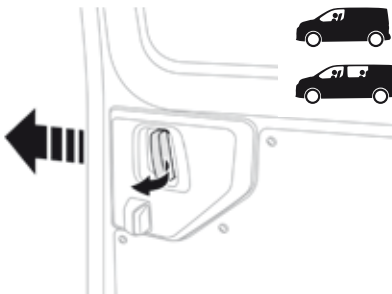

- ☞ Push the handle forward to close the door, and if necessary lock the vehicle.



For more information on the **Key, Remote control** or **Keyless Entry and Starting** and in particular locking the vehicle, refer to the corresponding section.

2



If a sliding side door is not fully closed:

- vehicle stationary and engine running, this warning lamp comes on, accompanied by an alert message for a few seconds,
- vehicle moving (speed above 6 mph (10 km/h)), this warning lamp comes on, accompanied by an audible signal and an alert message for a few seconds.

Electric sliding side door(s)

The exterior and interior door handles and the interior buttons allow the electrically powered movement of the door to be started.

Opening and closing of the doors is accompanied by an audible signal.

Opening From outside

Using the remote control



☞ Door unlocked, press and hold this button until the corresponding sliding side door has opened.



☞ Press this button again to reverse the movement of the door.



i The remote controls buttons are not active with the ignition switched on.

Using the handle



- ☞ Door unlocked, pull and release the handle to start the electrically powered opening of the door.
- ☞ Pull the handle again to reverse the movement of the door.

From inside

Using the handle

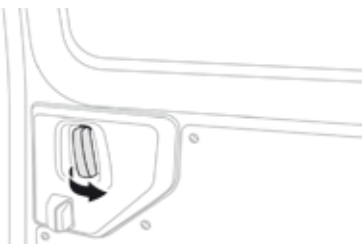

Vehicle locked



Cab and loading area selectivity deactivated.

- ☞ Pull the handle toward the rear to **totally** unlock the vehicle and start the electrically powered opening of the door.



Cab and loading area selectivity activated.

- ☞ Pull the handle toward the rear to unlock the **loading area** and start the electrically powered opening of the door.

Vehicle unlocked



Child lock off (deactivated).

- ☞ Pull the handle toward the rear to start the electrically powered opening of the door.



From inside, total unlocking then opening



Cab and loading area selectivity deactivated.

- i** For more information on the **Key, Remote control** or **Keyless Entry and Starting** and in particular total or selective unlocking, refer to the corresponding section.

Using the button(s) at the front

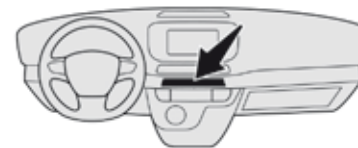

- ☞ To unlock the **vehicle** and start the electrically powered opening of a door, press the button for the corresponding door.
- ☞ Pressing the button again reverses the movement of the door.

- i** The button is inoperative and accompanied by an audible signal, if:
 - the vehicle is moving,
 - the vehicle has been locked or deadlocked from outside (using the key, remote control or Keyless Entry and Starting, depending on equipment).

Depending on equipment, the button for the left hand door is inoperative and accompanied by an audible signal, if the fuel filler flap is open.

2



From inside, selective unlocking then opening



Cab and loading area selectivity activated.

i For more information on the **Key, Remote control** or **Keyless Entry and Starting** and in particular total or selective unlocking, refer to the corresponding section.

Using the button(s) at the front

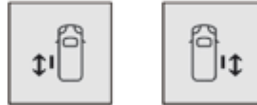

- ☞ To unlock the **loading area** only and start the electrically powered opening of a door, press the button for the corresponding door.
- ☞ Pressing the button again reverses the movement of the door.

i The button is inoperative and accompanied by an audible signal, if:

- the vehicle is moving,
- the vehicle has been locked or deadlocked from outside (using the key, remote control or Keyless Entry and Starting, depending on equipment).

Depending on equipment, the button for the left hand door is inoperative and accompanied by an audible signal, if the fuel filler flap is open.

From inside, unlocking then opening



i For more information on the **Child lock**, refer to the corresponding section.

Using the button(s) at the front

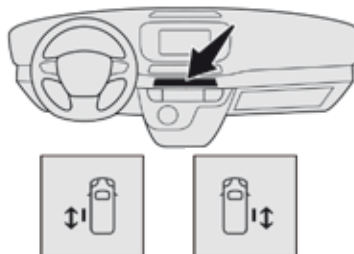

- ☞ Child lock deactivated, to unlock the vehicle and start the electrically powered opening of a door, press the button for the corresponding door.
- ☞ Pressing the button again reverses the movement of the door.

i The button is not operational and pressing it results in an audible signal, if:

- the vehicle is moving,
- the vehicle has been locked or deadlocked from outside (using the key, remote control or Keyless Entry and Starting, depending on equipment),
- the child lock is on (activated).

The button for the left-hand door is not operational and pressing it results in an audible signal if the fuel filler flap is open.

Using the button(s) on the door pillar

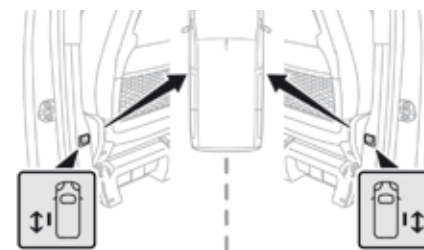

- ☞ Child lock deactivated, to unlock the vehicle and start the electrically powered opening of a door, press the button for the corresponding door.
- ☞ Pressing the button again reverses the movement of the door.

i The button is not available and accompanied by an audible signal, if:

- the vehicle is moving,
- the vehicle has been locked or deadlocked from outside (using the key, remote control or Keyless Entry and Starting, depending on equipment),
- the child lock is on (activated).

The button for the left-hand door is not available and is accompanied by an audible signal if the fuel filler flap is open.

Closing

From outside

Using the remote control



- ☞ Press and hold this button until the sliding door has closed.



- ☞ Press this button again to reverse the movement of the door.



i The remote controls buttons are not active with the ignition switched on.

Using the handle

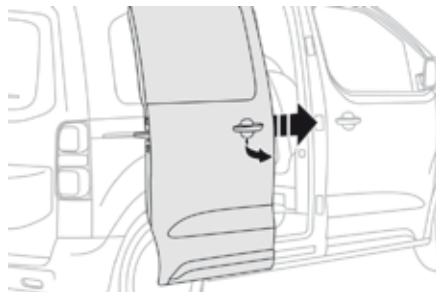

- ☞ Pull and release the handle to start the electrically powered opening of the door.
- ☞ Pull the handle again to reverse the movement of the door.

From inside

Using the button(s) at the front



- ☞ To start the electrically powered opening of the door, press the button for the corresponding door.
- ☞ Pressing the button again reverses the movement of the door.

i The button is not operational and pressing it results in an audible signal, if the speed of the vehicle is above 20 mph (30 km/h).

Using the button(s) on the door pillar

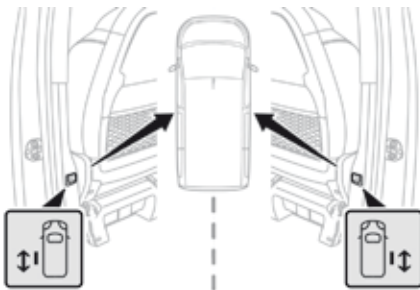

- ☞ To start the electrically powered opening of a door, press the button for the corresponding door.
- ☞ Pressing the button again reverses the movement of the door.

i The button is not operational and pressing it results in an audible signal, if the speed of the vehicle is above 20 mph (30 km/h).



- If a sliding door is not fully closed:
- vehicle stationary and engine running, this warning lamp comes on, accompanied by an alert message for a few seconds,
 - vehicle moving (speed above 6 mph (10 km/h)), this warning lamp comes on, accompanied by an audible signal and an alert message for a few seconds.

Manual or electric sliding side door(s)

! General recommendations

The doors must only be operated when the vehicle is stationary.

For your safety and for that of your passengers, as well as for correct operation of the doors, you are strongly advised not to drive with a door open.

Always check that it is safe to operate the door and in particular, be sure not to leave children or animals near the door controls without supervision.

The audible warning, illumination of the "door open" warning lamp and the message in the multifunction screen are there to remind you. Contact a CITROËN dealer or a qualified workshop to deactivate these warnings. Lock your vehicle when using an automatic car wash.

! Before any opening or closing and during any movement of the doors, ensure that no person, animal or object is protruding through the window frame or might prevent the intended manoeuvre, either inside or outside the vehicle.

If this advice is not followed, injuries or damage may occur if a person or an object is trapped or caught.

Electric closing and opening of the doors is not possible above 2 mph (3 km/h):

- If you set off with the door(s) open, you must slow down to below 20 mph (30 km/h) in order to close the door(s).
- Any attempt to open a door electrically using the interior handle while driving, results in only being possible to open the door manually.
- This situation is accompanied by the audible warning, illumination of the "door open" warning lamp and the message in the multifunction screen. To release the door and be able to operate it again, it is necessary to stop the vehicle.

i The electric controls are inhibited in the event of an impact. Manual opening and closing remain possible.

i While starting the engine, the movement of a door is interrupted and restored once the engine is running.

i
ECO Depending on the engine, in Stop mode of Stop & Start, if the door is closed and you initiate opening of the door, the door opens partially and stops. When the engine changes automatically to Start mode, the door continues its movement.

The doors and the overall dimensions of the vehicle

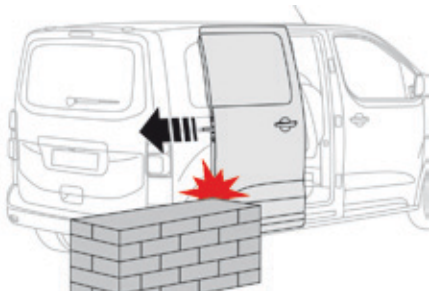

When open, a door projects beyond the body. Be sure to take this into account when you park alongside a wall, a post or a high kerb...

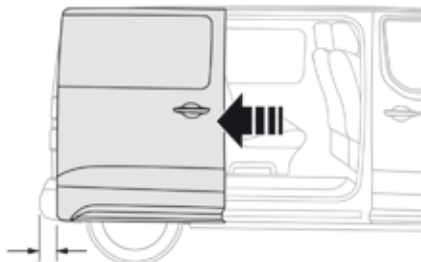

i When open, a door never projects beyond the rear bumper.

Safety / Obstacle detection with electric door(s)

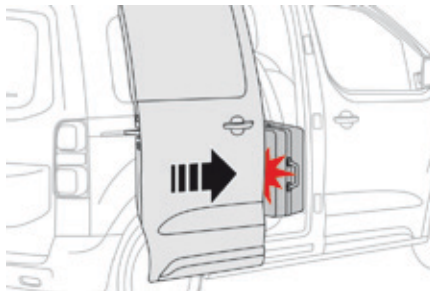

The obstacle detection system is triggered when the moving door encounters an obstacle with a certain level of physical resistance.

- If an obstacle is detected while the door is closing, the door stops then opens fully.
- If an obstacle is detected while the door is opening, the door stops and then closes.
- If an obstacle is detected twice in succession during a movement of the door, it will no longer close electrically. Close the door manually to reinitialise it.

Fuel filler flap

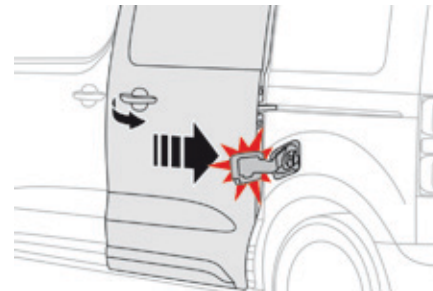

! If fitted to your vehicle, never open the left-hand sliding side door when the fuel filler flap is open. Otherwise you risk damaging the fuel filler flap and the sliding door and causing injury to the person filling the vehicle.

! If the fuel filler flap is open and your vehicle has an electric left-hand sliding side door, the door cannot be opened using the opening control button. If required the door can be opened half way manually. The fuel filler flap must be closed to allow the door to open correctly

2

On a steep slope

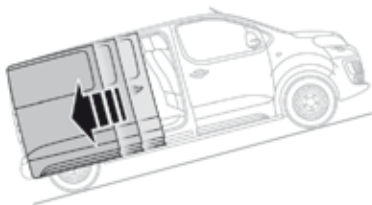

It is possible to open and close the doors electrically on slopes of up to 20%.

However, if your vehicle is on a slope, with the front of the vehicle facing up, open the door with care. The door may open more quickly due to the incline.

On a steep slope, guide the side door manually to help it to close.

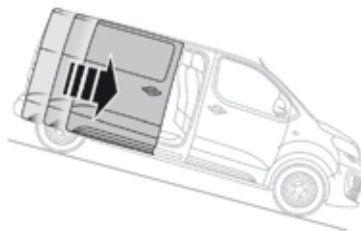

However, if your vehicle is on a slope, with the front of the vehicle facing down, the door may not stay open and may close again jerkily with the risk of injury.

! In the case of a steep slope, the door may be driven by its own weight and as a consequence may open or close jerkily.

There would not be time for action at the electric controls to take effect.

There would not be time for the obstacle detection system to react.

Take care not to leave the vehicle on a steep slope with the door(s) open without supervision. If this advice is not followed, injuries or damage may occur if a person or an object is trapped or caught.

Reinitialising electric doors

Following disconnection of the battery with the doors open, it may be necessary to close the doors manually to reinitialise them.

If the doors no longer work electrically, reinitialise the door(s) as follows:

- ☞ Fully close the door(s) manually.
- ☞ Fully open the door(s) manually.
- ☞ Close the door(s) manually.
- ☞ Fully open the door(s) manually.
- ☞ Close the door(s) manually.

On completion of this procedure, electric operation of the doors is restored.

However, if a problem persists following this procedure, contact a CITROËN dealer or a qualified workshop.

Hands-free sliding side door(s)

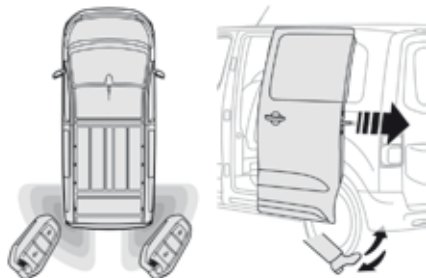

By keeping the remote control on your person and with a movement of your foot, the system unlocks and opens the sliding side door or closes and locks it.

The remote control must be located at the rear of the vehicle, more than about 30 cm and less than about 2 m from the vehicle.

- i The automatic locking after closing the door is programmable in the vehicle configuration menu.

! Before making the movement with your foot, ensure that you are steady and well positioned, so that you do not lose your balance (rain, snow, ice, mud, ...). Take care not to touch the exhaust tailpipe when making the movement with your foot - risk of burns.

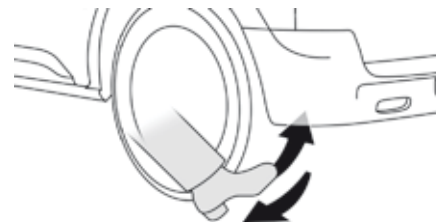

2

- f Pass your foot below the rear bumper then remove it, as though kicking (upwards). The sensor detects your foot approaching and leaving and triggers opening or closing of the side door.

- i Make the movement without interruption and do not repeat it immediately afterwards or several times. If the door does not open, wait about 2 seconds before trying again. Do not leave your foot in the air.

Opening

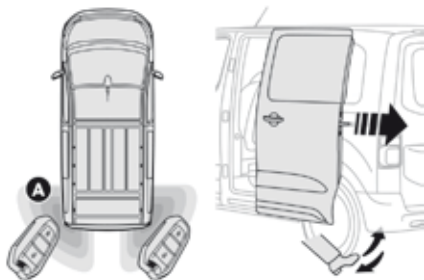

With "**Hands-free access**" activated in the vehicle configuration menu.

- ☞ With the remote control on your person and in the recognition zone **A**, pass your foot under the outer rear bumper, on the side you want to open the door.

i Confirmation that the door is going to open is signalled by the direction indicators flashing for a few seconds, accompanied by an audible signal. The movement of the door is reversed if you pass your foot under the bumper during operation of the door. If fitted to your vehicle, the electric door mirrors unfold on unlocking the vehicle.



Cab and loading area selectivity deactivated.

If the vehicle is locked, it is unlocked before opening the door.



Cab and loading area selectivity activated.

If the vehicle is locked, the **loading area** is unlocked before opening the door.



If the vehicle is locked, it is unlocked before opening the door.

i For more information on the **Key, Remote control** or **Keyless Entry and Starting**, and in particular total or selective locking, refer to the corresponding section.

Closing

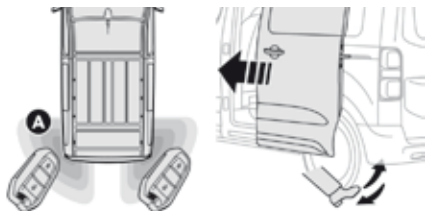

With "**Hands-free access**" activated in the vehicle configuration menu.

- ☞ With the remote control on your person and in the recognition zone **A**, pass your foot under the outer rear bumper, on the side you want to close the door.

Once the door has closed, the vehicle locks itself automatically, if "**Hands-free access self-locking**" has been selected in the vehicle configuration menu.

- i** Confirmation that the door is going to close is signalled by the direction indicators flashing for a few seconds, accompanied by an audible signal. The movement of the door is reversed if you pass your foot under the bumper during operation of the door. If fitted to your vehicle, the electric door mirrors fold on locking the vehicle.

Deactivation

By default, hands-free access is activated. The function can be deactivated in the vehicle configuration menu.

Automatic locking

The vehicle locks itself following the hands-free closing of a sliding door.

The automatic locking can be deactivated in the vehicle configuration menu.

- i** If your vehicle is not fitted with an alarm, locking is confirmed by fixed illumination of the direction indicators for about two seconds. Depending on version, the door mirrors fold at the same time.

With the audio system



In the "**Personalisation-Configuration**" menu, activate/deactivate "**Hands-free access**".

With the touch screen



In the vehicle settings menu, activate/deactivate "**Hands-free access**".



Then, if you want automatic locking after closing the door, activate/deactivate "**Hands-free access self-locking**".

Operating fault

An audible signal repeated three times indicates a fault with the system.

Contact a CITROËN dealer or a qualified workshop to have the system checked.

i If "**Hands-full access self-locking**" is selected in the vehicle menu and after closing the door, check that your vehicle has locked correctly.

This is because locking will not take place:

- if the ignition is on,
- if one of the doors or the tailgate is open,
- if a "Keyless Entry and Starting" remote control is inside the vehicle.

If a number of gestures with your foot have no effect, wait a few seconds before starting again.

The system is automatically deactivated in heavy rain or with accumulations of snow.

If the system fails to work, check that the remote control is not exposed to a source of electromagnetic interference (smartphone, ...).

Operation may be affected if using a prosthetic leg.

This system may not work correctly if your vehicle is fitted with a towbar.

i The sliding door may open or close erratically if:

- your vehicle is fitted with a towbar,
- you attach or detach a trailer,
- you fit or remove a bicycle carrier,
- you load or unload bicycles on a bicycle carrier,
- you remove or raise something behind the vehicle,
- an animal approaches the bumper,
- you wash your vehicle,
- a service is being carried out on your vehicle,
- you change a wheel.

To avoid unwanted operation, keep the key away from the detection zone or deactivate the function in the vehicle configuration menu.

! Ensure that no person or object could prevent the correct opening or closing of the doors.
Be aware of children when operating the doors.

Side-hinged rear doors

The side-hinged rear doors are asymmetrical. The left-hand door is fitted with a lock.

From outside



- ☞ After unlocking the vehicle (using the key, remote control or Keyless Entry and Starting, depending on equipment) pull the door handle.

i For more information on the **Key**, **Remote control** or **Keyless Entry and Starting** and in particular unlocking the vehicle, refer to the corresponding section.

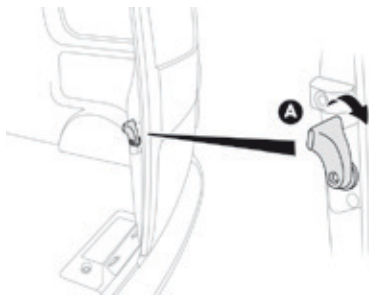

- ☞ After first opening the left-hand door, pull the lever **A** towards you to open the right-hand door.

Closing

- ☞ Close first the right-hand door, then the left-hand door.

i



If the left-hand door is closed first, a buffer stop located on the edge of the right-hand door prevents it closing.



If the left-hand door is not fully closed (the right-hand door is not detected):

- vehicle stationary and engine running, this warning lamp comes on, accompanied by an alert message for a few seconds,
- vehicle moving (speed above 6 mph (10 km/h)), this warning lamp comes on, accompanied by an audible signal and an alert message for a few seconds.

2

Opening to approximately 180°

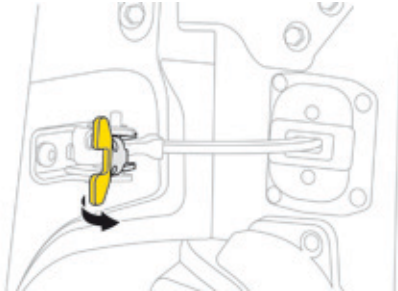

If fitted to your vehicle, a check strap system that allows the doors to be opened from about 90° to about 180°.

☞ Pull the yellow control when the door is open.

The check strap will engage again automatically on closing.



When parked with the rear doors open to 90°, the doors mask the rear lamps. To signal your position to other road users driving in the same direction who may not have seen your vehicle, use a warning triangle or other device required by the legislation in your country.



Opening to about 235°

If fitted to your vehicle, the hinges include three notches which allow the door to be held open at 90°, 180° or 235°.

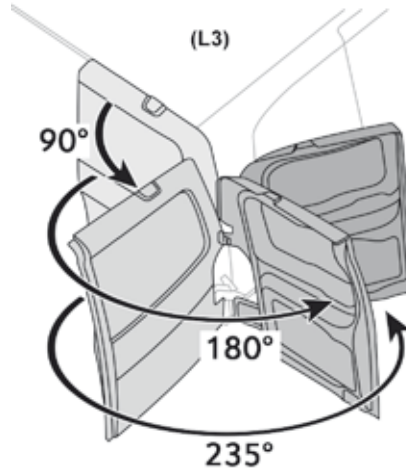

☞ Open the door to the desired position.

From inside

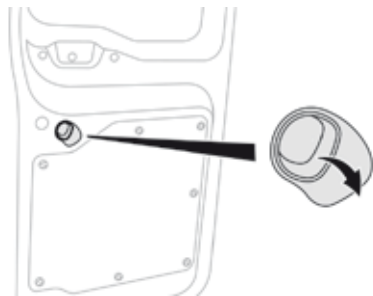

Opening



Cab and loading area selectivity deactivated and the vehicle locked.

- ☞ Twist this handle down to **totally** unlock the vehicle and open the right-hand door.



Cab and loading area selectivity activated and the vehicle locked.

- ☞ Twist this handle down to unlock the **loading area** and open the right-hand door.



Door or vehicle unlocked.

- ☞ Twist this handle down to open the right-hand door.



Vehicle locked.

- ☞ Twist this handle down to **totally** unlock the vehicle and open the right-hand door



Vehicle unlocked.

- ☞ Twist this handle down to open the right-hand door.



Vehicle locked and child lock off (deactivated).

- ☞ Twist this handle down to **totally** unlock the vehicle and open the right-hand door.



Vehicle unlocked and child lock off (deactivated).

- ☞ Twist this handle down to open the right-hand door.

i If the child lock is on (activated), the handle is inoperative.

i For more information on the **Child lock**, refer to the corresponding section.

Closing

- ☞ First close the right-hand door, then the left-hand door.

2

Tailgate

Opening

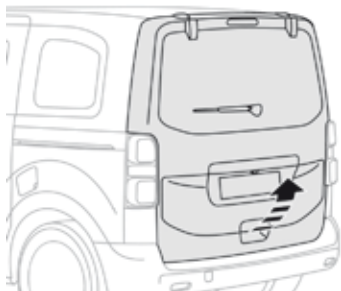

- ☞ After unlocking the vehicle with the key, the remote control or the Keyless Entry and Starting, pull the handle, then raise the tailgate.

i For more information on the **Key, Remote control** or **Keyless Entry and Starting** and in particular unlocking the vehicle, refer to the corresponding section.

Closing

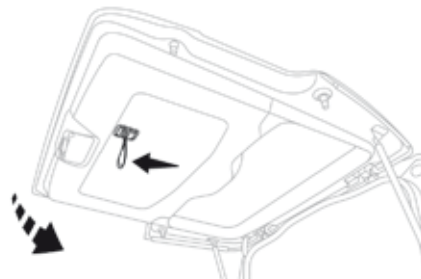

- ☞ Lower the tailgate using the interior grab handle then push it home to fully close it.

If the tailgate is not fully closed:



- vehicle stationary and engine running, this warning lamp comes on, accompanied by an alert message for a few seconds,
- vehicle moving (speed above 6 mph (10 km/h)), this warning lamp comes on, accompanied by an audible signal and an alert message for a few seconds.

i For more information on the **Key, Remote control** or **Keyless Entry and Starting** and in particular on locking the vehicle, refer to the corresponding section.

Back-up control

It allows the mechanical unlocking of the tailgate in the event of a battery or central locking system malfunction.

Unlocking

- ☞ If fitted to your vehicle and if necessary, fold back the rear seats to gain access to the lock from inside.

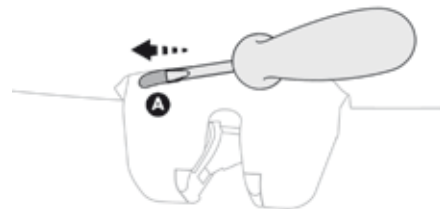

- ☞ Insert a small screwdriver into hole **A** of the lock to unlock the tailgate.
- ☞ Move the latch to the left.

Locking after closing

If the fault persists after closing again, the tailgate will remain locked.

Alarm

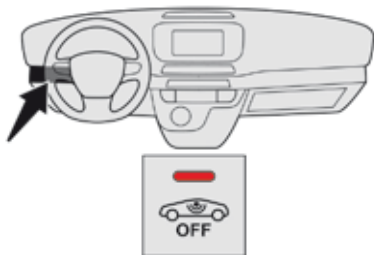

System which protects and provides a deterrent against theft and break-ins.

! Self-protection function

The system checks for the disconnection of any of its components. The alarm is triggered if the battery, the button or the siren wiring is disconnected or damaged.

For all work on the alarm system, contact a CITROËN dealer or a qualified workshop.

Exterior perimeter

The system checks for opening of the vehicle. The alarm is triggered if anyone tries to open one of the doors or the bonnet.



Volumetric

The system monitors variations in volume in the **cab** only. The alarm is triggered if someone breaks the windscreen or penetrates the **cab**. It is not triggered if someone penetrates the **loading area**.



Volumetric

The system monitors the passenger compartment for any variation in volume. The alarm is triggered if someone breaks the windscreen, penetrates the passenger compartment or moves around inside the vehicle.

i If your vehicle is fitted with the programmable heating / ventilation, volumetric monitoring is not compatible with this system. For more information on **Programmable Heating / Ventilation**, refer to the corresponding section.

Total protection

Activation

☞ Switch off the ignition and get out of the vehicle.



☞ Lock the vehicle using the remote control.

or

☞ Lock the vehicle using the "Keyless Entry and Starting" system.

The monitoring system is active: the indicator lamp in the button flashes once per second and the direction indicators come on for about 2 seconds.

Following a command to lock the vehicle using the remote control or the Keyless Entry and Starting system, the exterior perimeter monitoring is activated after a delay of 5 seconds, the interior volumetric monitoring after 45 seconds.

If an opening (door, tailgate or side-hinged doors, bonnet...) is not closed fully, the vehicle is not locked but monitoring will be activated after a delay of 45 seconds.

Deactivation



- Press this unlocking button on the remote control.

or

- Unlock the vehicle using the "Keyless Entry and Starting" system.

The monitoring system is deactivated: the indicator lamp in the button is off and the direction indicators flash for about 2 seconds.

i If the vehicle locks itself automatically (this occurs after 30 seconds if one of the doors is not opened), the monitoring system is reactivated automatically.

Protection - exterior perimeter monitoring only

Deactivate the interior volumetric monitoring to avoid unwanted triggering of the alarm in certain cases such as:

- occupant(s) present in the vehicle,
- leaving a window partially open,
- washing your vehicle,
- changing a wheel,
- towing your vehicle,
- transport on a ferry.

Volumetric monitoring

Deactivation



- Switch off the ignition and within ten seconds press this button until its indicator lamp is on fixed.

- Get out of the vehicle.



- Immediately lock the vehicle using the remote control or the "Keyless Entry and Starting" system.

Only the exterior perimeter protection system is active: the indicator lamp in the button flashes once per second.

To be effective, this deactivation must be done every time the ignition is switched off.

Reactivation



- Deactivate the exterior perimeter monitoring by unlocking the vehicle using the remote control or the "Keyless Entry and Starting" system.

The indicator lamp in the button goes off.



- Reactivate the full alarm system by locking the vehicle using the remote control or the "Keyless Entry and starting" system.

The indicator lamp in the button flashes once per second again.

Triggering of the alarm

This is indicated by sounding of the siren and flashing of the direction indicators for thirty seconds.

The monitoring functions remain active until the alarm has been triggered eleven times in succession.



- When the vehicle is unlocked using the remote control or the "Keyless Entry and Starting" system, rapid flashing of the indicator lamp in the button informs you that the alarm was triggered during your absence. When the ignition is switched on, this flashing stops immediately.

Failure of the remote control

To deactivate the monitoring functions:

- ☞ Unlock the vehicle using the key (integral with the remote control with Keyless Entry and Starting) in the driver's door lock.
- ☞ Open the door; the alarm is triggered.
- ☞ Switch on the ignition; the alarm stops. The indicator lamp in the button goes off.

Locking the vehicle without activating the alarm

- ☞ Lock or deadlock the vehicle using the key (integral with the remote control with Keyless Entry and Starting) in the driver's door lock.

Operating fault



When the ignition is switched on, fixed illumination of the indicator lamp in the button indicates a fault in the system.

Have it checked by a CITROËN dealer or a qualified workshop.

Automatic activation

This function is either not available, an option or is standard.

2 minutes after the last opening (door or boot) is closed, the system is activated automatically.

- ☞ To avoid triggering the alarm on entering the vehicle, first press the unlocking button on the remote control or unlock the vehicle using the "Keyless Entry and Starting" system.

Electric windows



1. Driver's electric window control
2. Passenger electric window control

There are two operating modes:

Manual mode

Press or pull the control, without passing the point of resistance. The window stops when you release the control.

Automatic mode

Press or pull the control, beyond the point of resistance. The window opens or closes fully when the control is released. Pressing the control again stops the movement of the window.

The electrical functions of the electric windows are deactivated:

- approximately 45 seconds after the ignition is switched off,
- after one of the front doors is opened, if the ignition is off.

Safety anti-pinch

If your vehicle is fitted with the safety anti-pinch function, when the window rises and meets an obstacle, it stops and partially lowers.

In the event of unwanted opening of the window on closing, press the control until the window is fully open. Within the next 4 seconds, pull the control until the window is fully closed.

The safety anti-pinch function does not operate during these operations.

Reinitialisation

Following reconnection of the battery, the safety anti-pinch function must be reinitialised.

- ☞ Lower the window fully, then raise it, it will rise in steps of a few centimetres each time the control is pressed.
- ☞ Repeat the operation until the window is fully closed.
- ☞ Continue to pull the control up for at least one second after the window closed position has been reached.

! The safety anti-pinch function does not operate during these operations.

! Always remove the key when leaving the vehicle, even for a short period.

If an electric window meets an obstacle during operation, you must reverse the movement of the window. To do this, press the control concerned.

When the driver operates the passenger electric window controls, they must ensure that no one is preventing the correct closing of the windows.

The driver must ensure that passengers use the electric windows correctly. Be aware of children when operating the windows.

Steering wheel adjustment



- ☞ **When stationary**, lower the control lever to release the steering wheel adjustment mechanism.
- ☞ Adjust the height and reach to suit your driving position.
- ☞ Pull the control lever to lock the steering wheel adjustment mechanism.

! As a safety precaution, these operations should only be carried out while the vehicle is stationary.

Front seats with manual adjustments

As a safety measure, seat adjustments should only be carried out when stationary.

Forwards-backwards



- ☞ Raise the control and slide the seat forwards or backwards.

i For more information on the **Seat belts**, refer to the corresponding section.

! Before moving the seat backwards, ensure that there is nothing that might prevent the full travel of the seat, so as to avoid the risk of jamming the seat caused by the presence of objects on the floor behind the seat or rear passengers. If the seat jams, stop the movement immediately.

Height

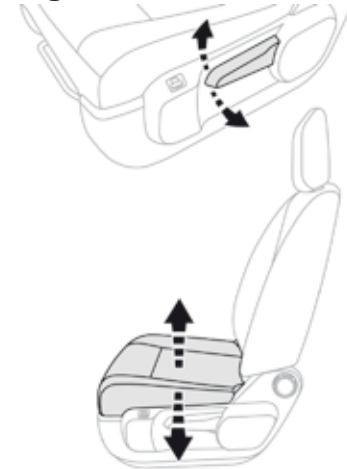

- ☞ If fitted to your vehicle, pull the control upwards to raise or push it downwards to lower, as many times as required to obtain the position required.

Backrest angle

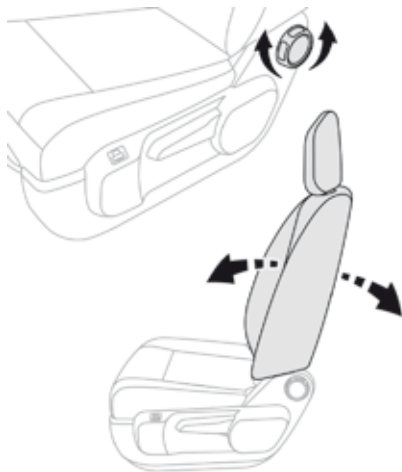

☞ Turn the knob to adjust the backrest.



☞ Pull the control fully up and move the backrest forward or backward.

Lumbar



☞ Turn the knob manually to obtain the desired level of lumbar support.



Table position for the driver's and/or the front passenger's seat backrest

On the front passenger's side, this position allows long objects to be carried.

On the driver's side, this position allows rear passengers to be helped out of the vehicle (by the emergency services).

! Check that there is no object that could interfere with the movement of a seat, both above and below.

☞ Place the head restraint in the low position, and if fitted to your vehicle, raise the armrest and fold the table on the back of the seat.



☞ Pull the control fully up and tip the backrest forward.

To return to the normal position, pull the control up to release the backrest, then pull the backrest up to its raised position.

Electric front seat Forwards-backwards

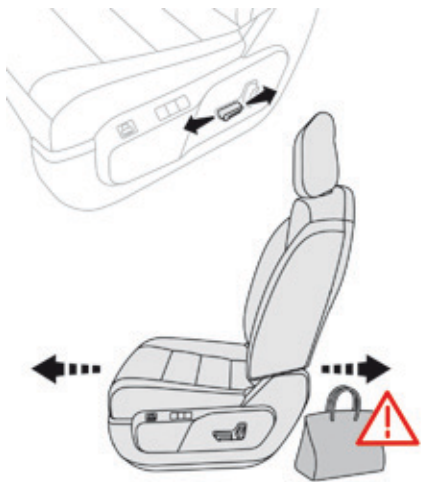

- ☞ Push the control forwards or rearwards to slide the seat.



Before moving the seat backwards, ensure that there is nothing that might prevent the full travel of the seat, so as to avoid the risk of jamming the seat caused by the presence of objects on the floor behind the seat or rear passengers. If the seat jams, stop the movement immediately.

Backrest angle

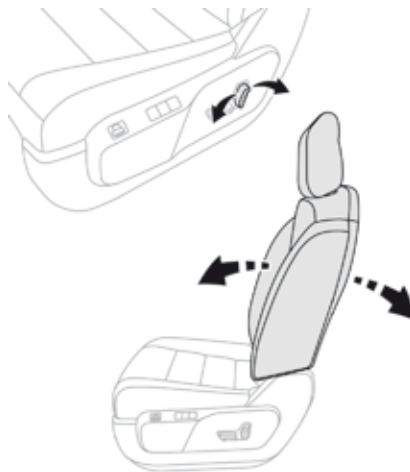

- ☞ Tilt the control forwards or rearwards to adjust the angle of the seat backrest.

Height

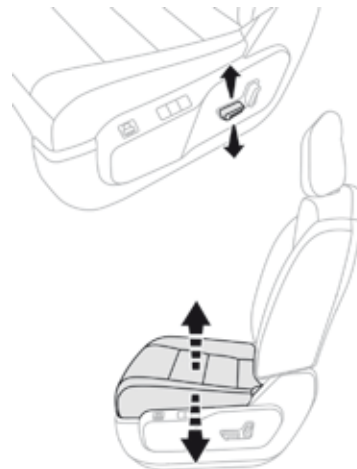

- ☞ Tilt the control upwards or downwards to obtain the desired height.



For more information on the **Seat belts**, refer to the corresponding section.



To avoid discharging the battery, carry out these adjustments with the engine running.

Additional adjustments

Head restraint height adjustment

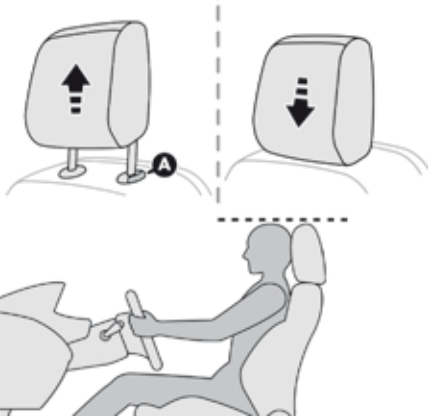

If fitted to your vehicle.

- ☞ To raise the head restraint, pull it upwards.
- ☞ To remove the head restraint, press the lug **A** and pull the head restraint upwards.
- ☞ To put the head restraint back in place, engage the head restraint rods in the apertures keeping them in line with the seat backrest.
- ☞ To lower the head restraint, press the lug **A** and the head restraint at the same time.

! The head restraint rods have notches which prevent the head restraint lowering; this is a safety device in case of impact.

The adjustment is correct when the upper edge of the head restraint is level with the top of the head.

Never drive with the head restraints removed; they must be in place and adjusted correctly.

Armrest

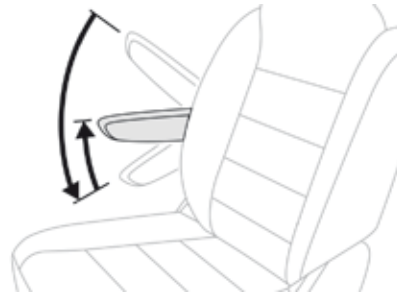

The armrest has notched positions.

- ☞ Raise the armrest fully up.
- ☞ Lower it fully down.
- ☞ Raise the armrest to the desired position.

Heated seats control

With the engine running, the front seats can be heated separately.

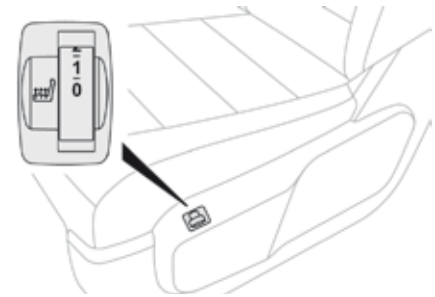

- ☞ Use the adjustment wheel to switch on and select the level of heating required:

0: Off.

1: Low.

2: Medium.

3: High.

2-seat front bench seat

If fitted to your vehicle, this is fixed and has a seat belt on the backrest for the seat alongside the driver.

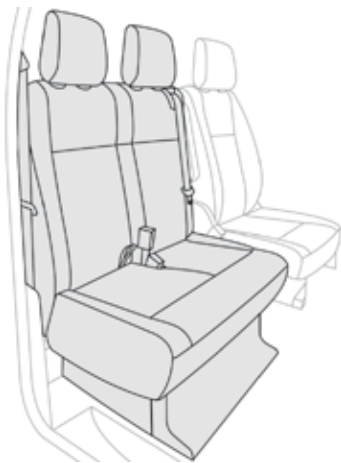

Head restraint height adjustment

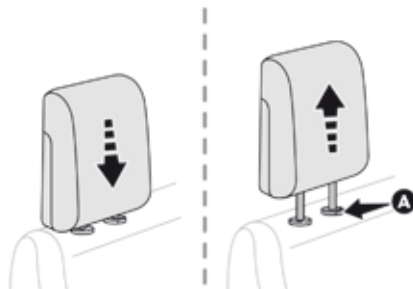

- ☞ To raise the head restraint, pull it upwards.
- ☞ To remove the head restraint, press the lug **A** and pull the head restraint upwards.
- ☞ To put the head restraint back in place, engage the head restraint stems in the openings keeping them in line with the seat back.
- ☞ To lower the head restraint, press the lug **A** and the head restraint at the same time.

i For more information on the **Seat belts**, refer to the corresponding section.

! The head restraint rods have notches which prevent the head restraint lowering; this is a safety device in case of impact.

The adjustment is correct when the upper edge of the head restraint is level with the top of the head.

Never drive with the head restraints removed; they must be in place and adjusted correctly.

Heated bench seat

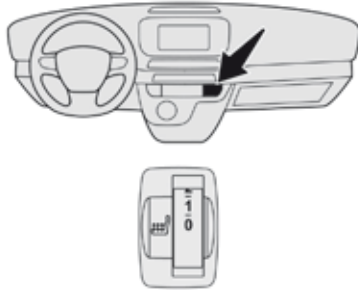

With the engine running, the bench seat cushions can be heated.

☞ Use the adjustment wheel to switch on and select the level of heating required:

- 0: Off.
- 1: Low.
- 2: Medium.
- 3: High.

Under-seat storage

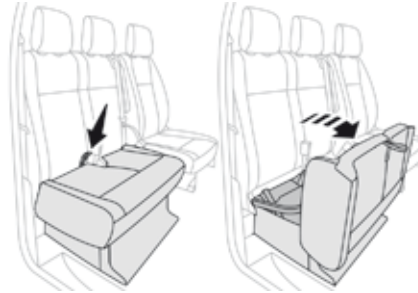

If your vehicle is so equipped, a storage space is provided under the seat.

☞ Pull the strap to tip the seat.

3



Moduwork

The cushion of the outer seat of the bench seat can be raised up to the backrest to create additional loading space in the cab.

A flap in the partition can be removed to allow long objects to be carried.

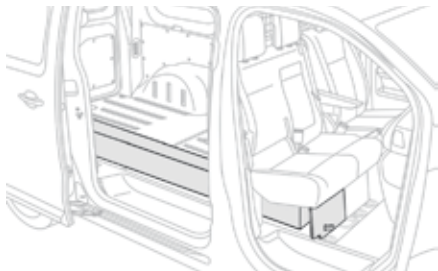
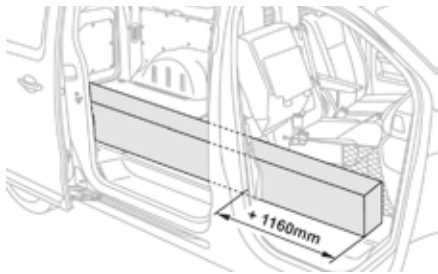

i Once the removable flap has been removed, you can load long objects under the outer seat.

Removable flap

Removing the flap

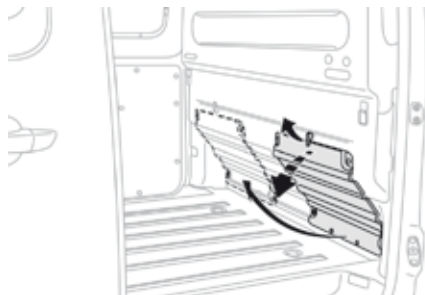

- ☞ Holding the flap with one hand, with your other hand turn the control at the top of the flap to release it.
- ☞ Lower the flap to remove it from its housing.



- ☞ Stow it behind the driver's seat, clipping it to the fixing lugs.
- ☞ Turn the control at the top of the flap to secure it.

Refitting the flap

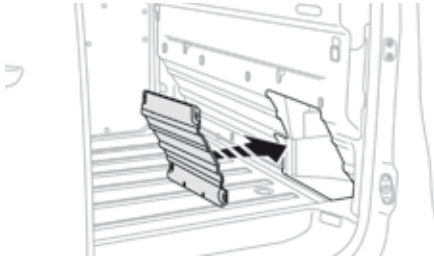

- ☞ Offer up the flap at an angle, with the yellow hinges pointing downward.

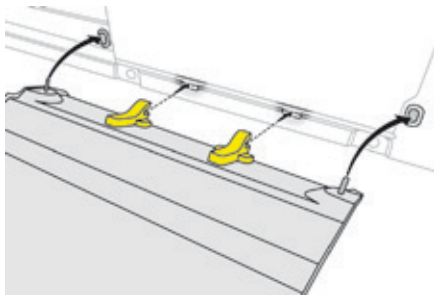

- ☞ Place the hinges in their housings then push fully down (to avoid vibrations).
- ☞ With one hand, raise the flap to close it, then with the other hand turn the control at the top of the flap to secure it.

Folding the seat cushion

Raising the seat cushion

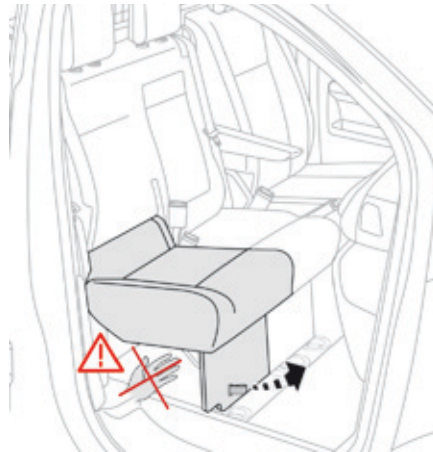

- ☞ With one hand, pull the strap firmly forward to release the seat cushion.



Never place your hand under the seat cushion to guide the seat upward; risk of trapping your fingers. Only the strap should be used.

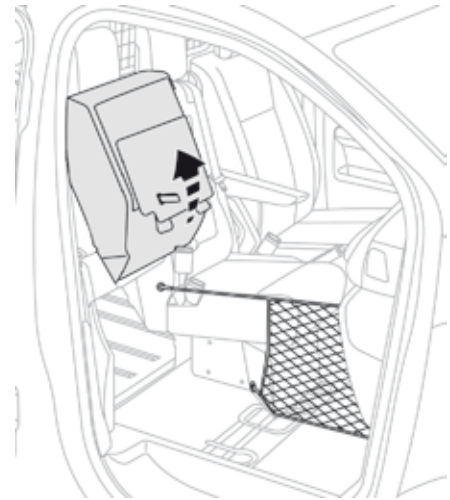

- ☞ A strut raises the cushion onto the backrest.



When the outer seat is raised and the flap removed, you must fit the non-slip net. Refer to the **Non-slip net** section.

3

Lowering the seat cushion

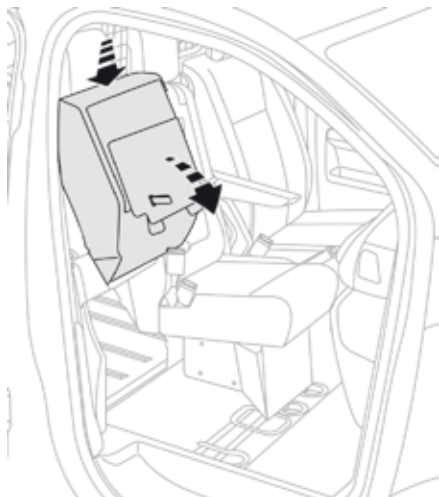

- ☞ Remove the non-slip net.
- ☞ To reposition the seat cushion, press firmly at the top of the seat with one hand to lower the seat cushion until it engages in the seating position.

Non-slip net Fitting the net

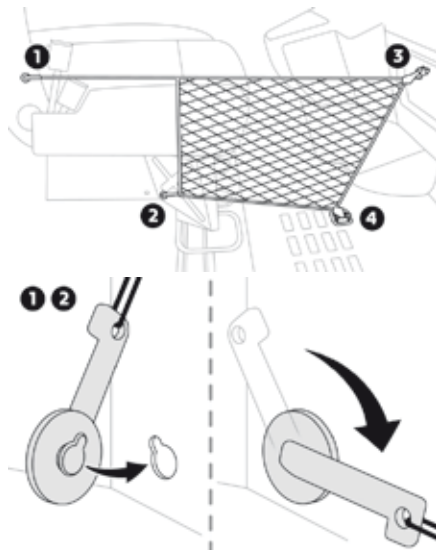

- ☞ Place the first fixing in the upper cut-out **1**, located on the folded cushion. Then turn it a quarter turn clockwise to secure it.
- ☞ Place the second fixing in the lower cut-out **2**, located on the seat support. Then turn it a quarter turn clockwise to secure it.

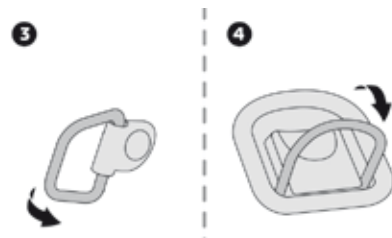

- ☞ Engage the first hook on the ring **3**, located in the open glove box.
- ☞ Engage the second hook on the ring **4**, located on the floor.

Removing the net

- ☞ Remove the hooks from the rings **4** and **3**.
- ☞ Remove the lower **2** then upper fixing **1**, by turning them a quarter turn anti-clockwise to release them.

! Ensure that the size, shape and volume of loads carried are compatible with the driving and safety regulations and do not compromise the driver's field of vision.

Lash all loads appropriately, to prevent or limit their movement and avoid the risk of injury.

Install the non-slip net (supplied with the vehicle) every time the seat is raised and the partition flap removed.

Do not use the net for other purposes. Check the condition of the non-slip net regularly. Replace it when it shows signs of wear or tears, going to a CITROËN to obtain a replacement non-slip net to the specification and quality defined by CITROËN for your vehicle.

Refit the flap in the partition when no longer carrying a long load.

Work table

If fitted to your vehicle, the backrest of the bench centre seat tips forward to form a pivoting work table, creating a mobile office (when stationary).

☞ Pull the grip at the top of the backrest.

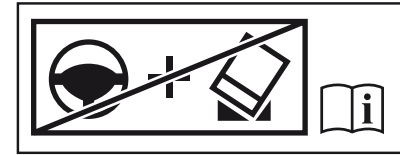
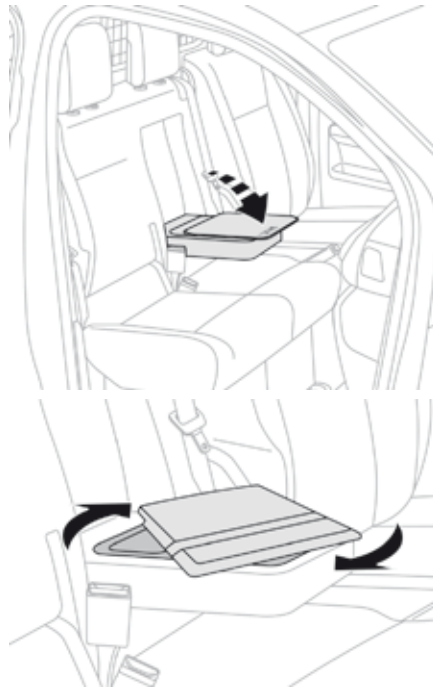

! Never use the table while driving. An object on the table could turn in to a projectile and cause injuries under heavy braking or in the event of an impact.

Centre seat storage

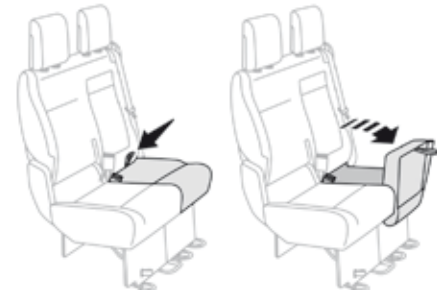

☞ Pull the strap forward to tip the seat cushion.

3



Fixed one-piece bench seat



The different items of equipment and adjustments described hereafter vary according to the version and the configuration of your vehicle.

The bench seat includes a one-piece backrest which may be fixed or folding (table position).

i For more information on the **Seat belts**, refer to the corresponding section.

Angled head restraints

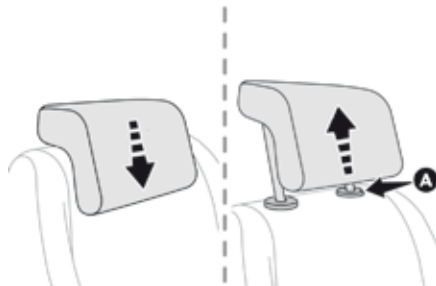

- ☞ To raise a head restraint, pull it up until it engages in its notches.
- ☞ To remove the head restraint, press the lug **A** and pull the head restraint upward.
- ☞ To put it back in place, engage the head restraint rods in the apertures keeping them in line with the seat backrest.
- ☞ To lower it, press on the lug **A** and on the head restraint at the same time.

Folding the seat backrest to the table position

- ☞ Place the head restraints in the low position.

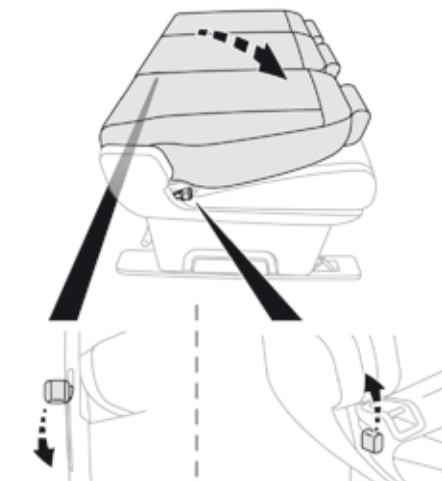

- ☞ From the front, raise the handle to release the seat backrest.
- ☞ From the rear, lower the handle to release the seat backrest.
- ☞ Fold the backrest onto the seat cushion.
- ☞ To return the backrest to its normal position, raise the handle and pull the backrest up.

Tipping, access to row 3

- ☞ If your vehicle has the facility, place the seat backrest in the table position.

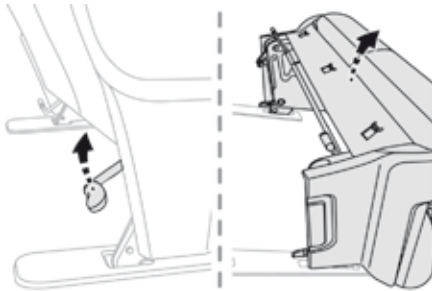

- ☞ Using the handle, release the rear feet then tip the seat forward.
- ☞ To return the seat, tip the bench towards the rear until the feet lock into place.

i It is not necessary to fold the backrest (table position) to tip the bench seat for access to row 3.

Removing a seat

- ☞ If your vehicle has the facility, place the backrest in the table position.
- ☞ Tip the seat forward.

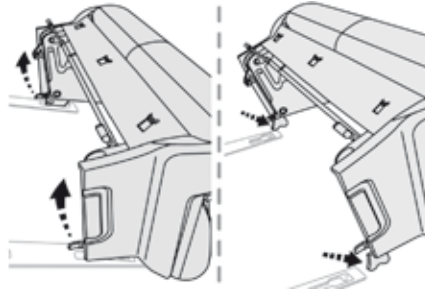

- ☞ Release the front feet using these handles.
- ☞ Disengage the seat from its anchorages.
- ☞ Remove the seat.

! If removing and storing a bench seat out of the vehicle, ensure that it is placed in a clean area, so as to avoid introducing any foreign bodies into the mechanisms.

! The bench seats are not designed for any use other than in the vehicle. They have mechanisms and functions that could be damaged if used incorrectly or are dropped.

3

Refitting a seat

- ☞ Check that there is nothing obstructing the anchorages or which would prevent the correct engagement of the feet.

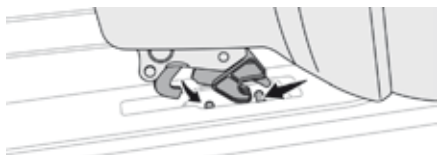

- ☞ Engage the front feet in the anchorages in the floor (as shown above).

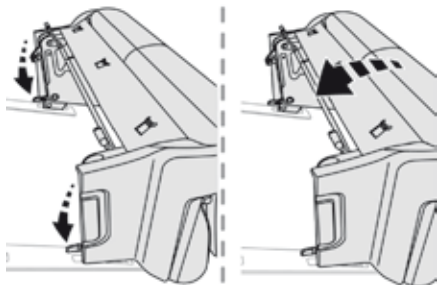

- ☞ Lock the front feet using the handles.
- ☞ Tip the seat toward the rear until the rear feet lock into place.

! Be aware of the feet of any passengers while tipping the seat.

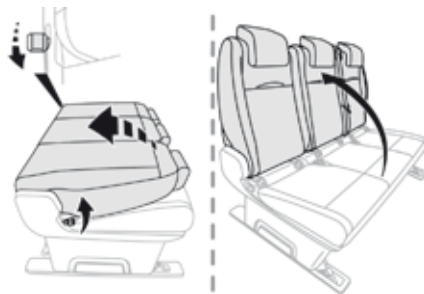

- ☞ If your vehicle has the facility, pull the control and raise the backrest (from the rear, lower the lever).

i Check that the seat has correctly engaged in its anchorages on the floor when returned to the seating position.



! Ensure that no object, or the feet of a passenger seated at the rear, could obstruct the anchorage points or prevent the correct latching of the assembly.



Fixed rear seat and bench seat

The different levels of equipment and adjustments described hereafter vary according to the version and the configuration of your vehicle.



The seat has a backrest that may be fixed or folding (table position).

The bench seat has a one-piece backrest that may be fixed or foldable (table position).

i For more information on the **Seat belts**, refer to the corresponding section.

Angled head restraints

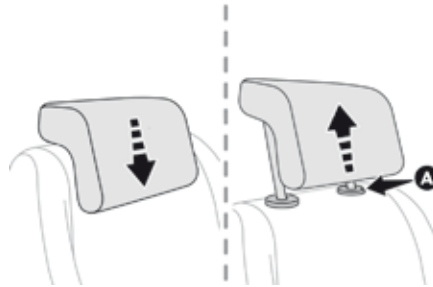

- ☞ To raise a head restraint, pull it up until it engages in its notches.
- ☞ To remove the head restraint, press the lug **A** and pull the head restraint upward.
- ☞ To put it back in place, engage the head restraint rods in the apertures keeping them in line with the seat backrest.
- ☞ To lower it, press on the lug **A** and on the head restraint at the same time.

Folding the backrest to the table position

- ☞ Put the head restraints into the low position.

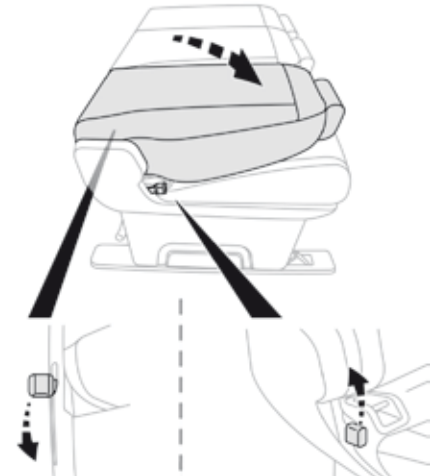

- ☞ From the front, raise the handle to release the backrest.
- ☞ From the rear, lower the lever to release the backrest.

3

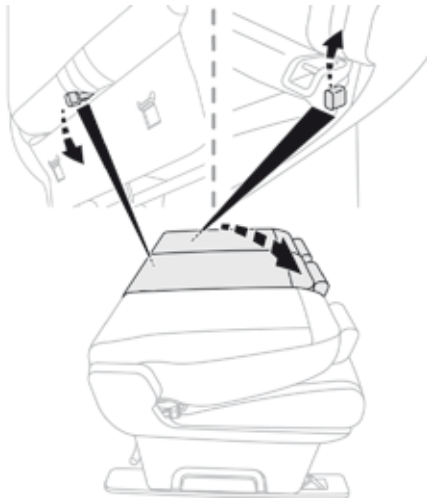

- ☞ Fold the backrest onto the cushion.
- ☞ To return the backrest to the normal position, raise the lever and pull the backrest up (from the rear, lower the lever).

Fully folding a seat, access to row 3

(example of an individual seat)

- ☞ If your vehicle has the facility, place the backrest in the table position.

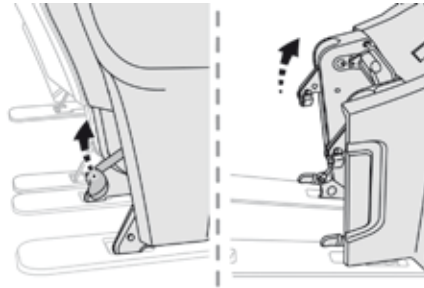

- ☞ Using the handle, release the rear feet then tip the seat forward.
- ☞ To return the seat to the normal position, unfold the seat backwards until the rear feet engage in their anchorages.

i It is not necessary to fold the backrest (table position) to tip the bench seat for access to row 3.

Removing a seat

(example of an individual seat)

- ☞ If your vehicle has the facility, place the backrest in the table position.
- ☞ Tip the seat forward.

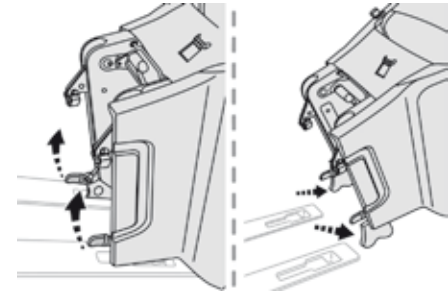

- ☞ Release the front feet using the handles.
- ☞ Disengage the seat from its anchorages.
- ☞ Remove the seat by the sliding door in row 2 or from the rear in row 3.

! If removing and storing a seat (or bench seat) out of the vehicle, ensure that it is placed in a clean area, so as to avoid introducing any foreign bodies into the mechanisms.

! The seats (or bench seats) are not designed for any use other than in the vehicle. They have mechanisms and functions that could be damaged if used incorrectly or are if the seat is dropped.

Refitting a seat

(example of an individual seat)

- ☞ Check that there is no object obstructing the anchorages and preventing the feet locking into place.

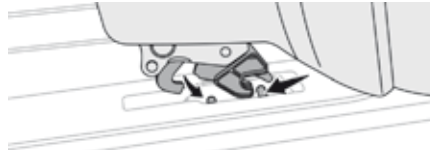

- ☞ Engage the front feet in the anchorages on the floor (as shown above).

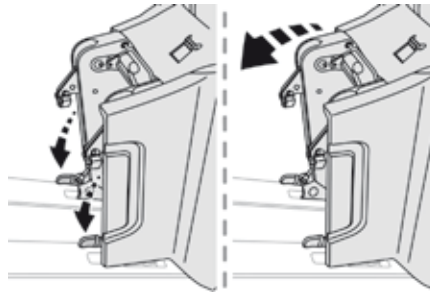

- ☞ Lock the front feet using the handles.
- ☞ Unfold the seat toward the rear until the rear feet lock into place.

Be aware of the feet of passengers when refitting a seat.

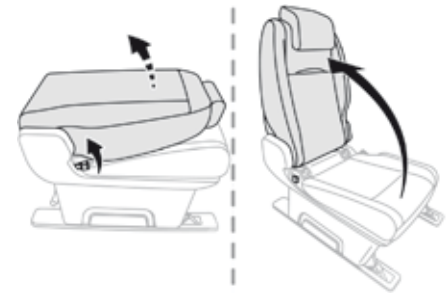

Check that the seat has locked into place on the floor when returning it to the seating position.

- i** ☞ If fitted to your vehicle, pull the control to raise the backrest (from the rear, lower the lever).



- !** Ensure that no object, or the feet of a passenger seated at the rear, could obstruct the anchorage points or prevent the correct latching of the assembly.

3

Precautions for the seats and bench seats

Following the various handling operations:

- do not remove a head restraint without storing it and fixing it to a support,
- check that the seat belts are always accessible to the passenger and easy to fasten,
- a passenger must not take their seat without adjusting the seat's head restraint correctly and adjusting and fastening the seat belt.

Loading luggage or objects behind the row 3 seat and bench seat

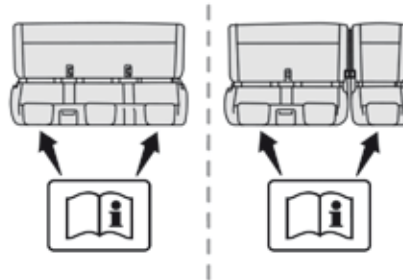

If you want to load luggage onto the backrests in row 3 while in the table position, the backrests in row 2 must also be in the table position.

Labels



When driving, carrying a passenger is prohibited:

- in row 3 if the backrest in front (row 2) is in the table position.
- in row 3 if the seat/bench in front (row 2) is in the fully folded position.
- in rows 2 and 3, in the outer right seat, if the bench is in the fully folded position,
- on the centre seat if the outer right seat is in the fully folded position.



Fixed crew cab

This comprises a bench seat, seat belts, storage spaces (depending on equipment) and side windows.

It is separated from the **loading area** by a high-strength partition offering comfort and safety.

Rear bench seat



This ergonomic bench seats three people. The two outer seats are equipped with ISOFIX mountings.

Storage boxes



If fitted to your vehicle, a storage box is provided at the front, under the bench seat.

i For more information on the **ISOFIX mountings**, refer to the corresponding section.

Storage boxes below the seats

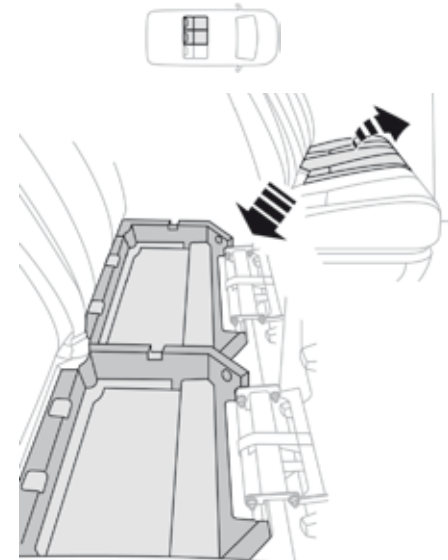

If fitted to your vehicle, they are located below the centre and outer left seat. For access to them from the cab, tip the seat cushion in question forward.

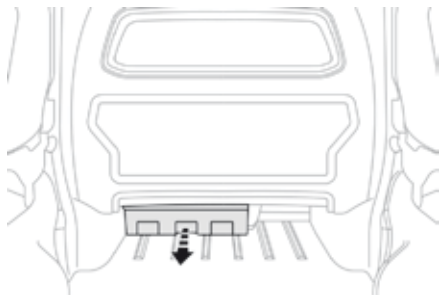

The storage boxes can be removed* and are extracted* from the rear, allowing long objects to be housed under the bench seat.

- i** No not attach anything to the cab fixing structure.
Do not exceed the number of passengers indicated on the registration certificate.
In the rear, the **loading area** is intended for carrying goods only.
You are advised to place heavy goods or objects as far forward as possible in the **loading area** (towards the cab) and secure them by means of straps using the stowing rings on the floor.
The rear seat belt frames are not intended for securing transported articles.

* Depending on the country of sale.

Interior fittings

Mats

Fitting

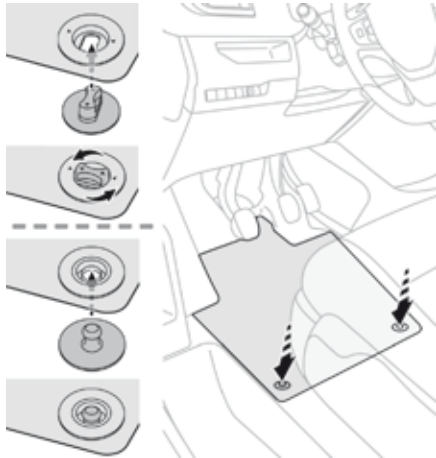

When fitting the mats for the first time, on the driver's side use only the fixings provided in the wallet attached.

Removal

To remove the mat on the driver's side:

- ☞ move the seat as far back as possible,
- ☞ unclip the fixings,
- ☞ remove the mat.

Refitting

To refit the mat on the driver's side:

- ☞ position the mat correctly,
- ☞ refit the fixings by pressing,
- ☞ check that the mat is secured correctly.



To avoid any risk of jamming of the pedals:

- only use mats which are suited to the fixings already present in the vehicle; these fixings must be used,
- never fit one mat on top of another.

The use of mats not approved by CITROËN may interfere with access to the pedals and hinder the operation of the cruise control / speed limiter.

The mats approved by CITROËN have two fixings located below the seat.

Sun visor

The sun visors provide protection from the sun from the front or the side and have an illuminated vanity mirror (depending on version).

A pocket is provided on the driver's sun visor to hold toll tickets, receipts, ...

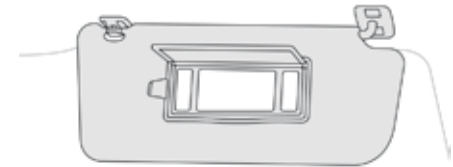

- ☞ With the ignition on, raise the concealing flap; the mirror is illuminated automatically.

Glove box

It houses the passenger front airbag deactivation switch and can hold a water bottle, the vehicle's handbook pack...



Storage compartment

It can hold a water bottle, the vehicle's handbook pack...

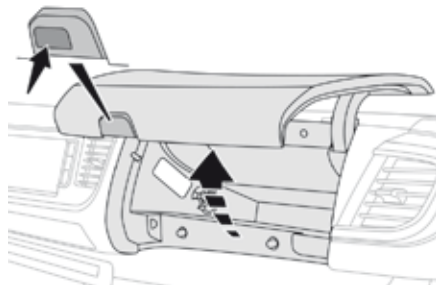

- To open the storage compartment, press the left hand end of the control and guide the lid to its open position notch.
- If it is so equipped, it is illuminated when the lid is opened.



With air conditioning, it gives access to the ventilation nozzle, delivering the same air-conditioned air as the vents in the passenger compartment.



While driving, keep the glove boxes closed. Otherwise there is a risk of injury in the event of an accident or sudden braking.

Front door pockets

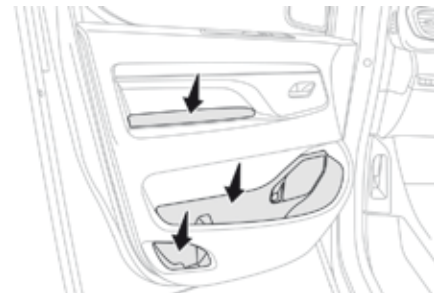

Liquids carried in an open vessel (a cup or mug) could be spilt, presenting a risk of damage on contact with the controls in the dashboard and centre console. Take care.

Upper storage compartment

This is located in the dashboard, behind the steering wheel.

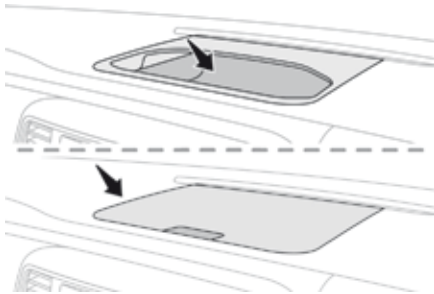

Press the control to open the lid (depending on version) then guide it to its fully open position. To close, guide the lid then press the centre gently.

Any liquid which could spill risks causing an electrical short circuit and therefore a potential fire.

12 V accessory socket(s) (depending on version)



- ☞ To connect a 12 V accessory (maximum power: 120 Watts), lift the cover and connect a suitable adaptor.

! Observe the maximum power rating to avoid damaging your accessory.

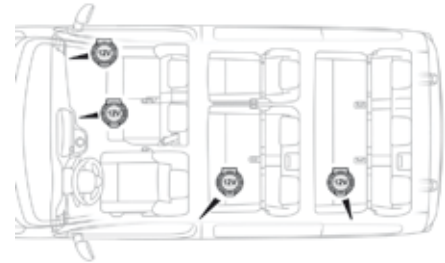

! The connection of an electrical device not approved by CITROËN, such as a USB charger, may adversely affect the operation of vehicle electrical systems, causing faults such as poor telephone reception or interference with displays in the screens.

3

USB port

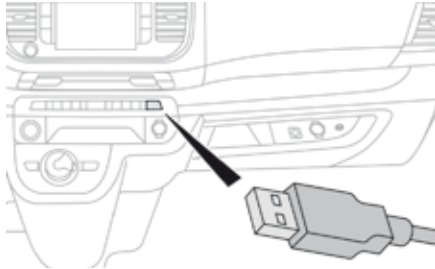

It allows the connection of a portable device, such as a digital audio player of the iPod® type or a USB memory stick. It reads the audio files which are transmitted to your audio system and played via the vehicle's speakers. You can manage these files using the steering mounted controls or the audio system.

i When a USB port is used, the portable device charges automatically. While charging, a message is displayed if the current consumption of the portable device exceeds the power rating of the port. For more information on using this equipment, refer to the **Audio and telematics** section.

Auxiliary socket



It permits the connection of a portable device so that you can listen to your music files via the vehicle's speakers. The management of the files is done using your portable device.

i For more information on the use of this equipment, refer to the **Audio and telematics** section.



Loading area fittings

Depending on the vehicle's equipment, the various fittings below are located in the loading area.

Lashing rings

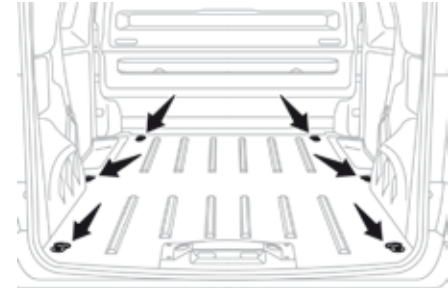

Use the lashing rings on the rear floor to secure your loads.

As a safety precaution in case of sharp braking, you are advised to place heavy objects as far forwards towards the cab as possible.

You are advised to immobilise the load by securing it firmly using the lashing rings on the floor.

Load retainer

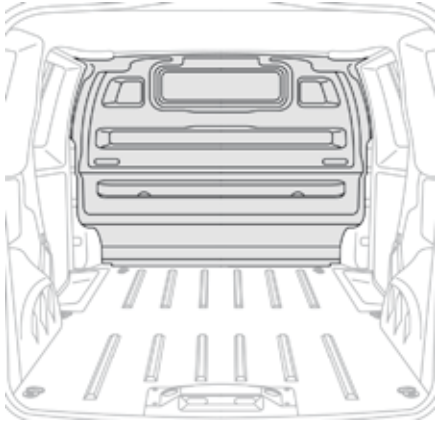

On the floor, behind the front seats, a horizontal partition protects the driver and front passengers against the risk of load movement. Panel or glazed partitions separate the loading area from the cab.



Seating area fittings

Depending on the vehicle's equipment, the various fittings below are located in the seating area.

High load retaining net

This allows the use of the entire load space, up to the roof:

- behind the front seats in row 1, when the rear seats (and bench seats) in rows 2 and 3 are folded or removed.
- behind the rear seats and bench seats in row 2, when the rear seats (and bench seats) in row 3 are folded or removed.

Upper fixings

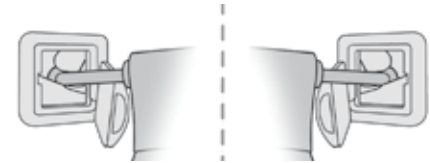

- ☞ Unclip the anchorage cover in the roof on each side.

Lower fixings (behind row 1)

If your vehicle has **fixed** one-piece bench seats or seats and bench seats:

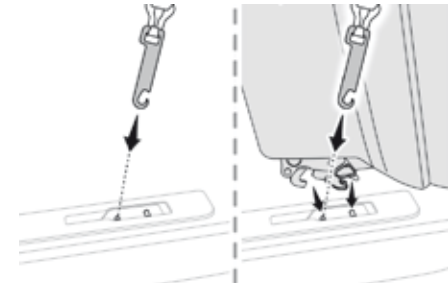

- ☞ On each side in row 2, insert the fixings in the floor anchorages (as shown above).

3

If your vehicle has seats and bench seats or individual seats on rails:

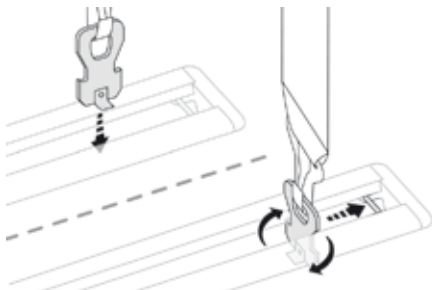

- ☞ On each side in row 2, insert the fixings in the floor anchorages then turn them a quarter turn to lock them in place (as shown above).

Place them as close as possible to the end of the rail.

Lower fixings (behind row 2)

- ☞ Use the stowing rings.

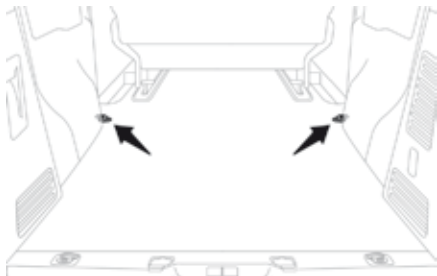

Fit the net

Unclip the upper fixing covers and secure the lower fixings (as previously described).

- ☞ Fold (table position) the seats and bench seats in rows 2 and 3 (according to equipment).
- ☞ Unroll the high load retaining net.
- ☞ Position the upper net fixings in the corresponding anchorages in the roof (first one side, then the other).
- ☞ Fully extend the straps.
- ☞ On each side, attach the bottom fixings of the net to the lower anchorages (behind row 1) or in the stowing rings (behind row 2).
- ☞ Pull on the straps to stretch the net.
- ☞ Check that the net is attached securely and properly extended.

! Never use the ISOFIX ring intended for fixing the upper strap of a child seat with Top Tether.

Windows in row 2

If fitted to your vehicle, the side windows in row 2 can be opened.

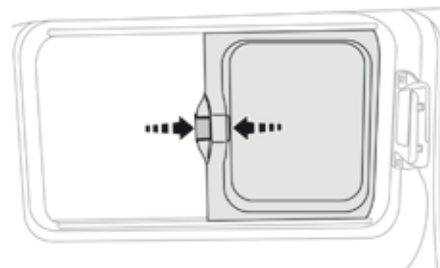

While driving, the window must be closed or secured at one of the notches.

- ☞ Squeeze the two controls then move the window sideways.

i For more information on the **Child lock for rear windows**, refer to the corresponding section.

Heating / Ventilation



Air flow

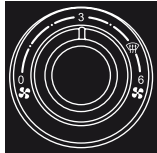

- ☞ Turn the knob to obtain the desired air flow.

i If you place the air flow control at the **minimum** position (off), the temperature in the vehicle will no longer be maintained. However, a slight flow of air can still be felt due to the movement of the vehicle.

Temperature

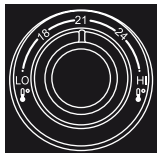

- ☞ Turn the knob from "LO" (cold) to "HI" (hot) to adjust the temperature to your wishes.

Air distribution



Windscreen and side windows.



Centre and side air vents.



Footwells.

The air distribution can be modulated by pressing additional buttons.

Air intake / Air recirculation

The intake of exterior air avoids misting of the windscreen and side windows. The recirculation of interior air insulates the passenger compartment from exterior odours and fumes.

i This allows hot or cold air to be delivered quickly when required.



- ☞ Press this button to recirculate the interior air; its indicator lamp comes on.



- ☞ Press this button again to allow exterior air into the passenger compartment; its indicator lamp goes off.

i Return to exterior air intake as soon as possible to avoid deterioration of the air quality and the formation of mist.

Manual air conditioning

The air conditioning system only operates with the engine running.



Air flow

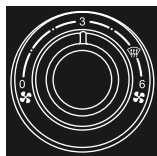

☞ Turn the knob to obtain a comfortable air flow.

i If you put the air flow control in the **minimum** position (system off), the temperature is no longer controlled. However, a slight flow of air can still be felt, resulting from the movement of the vehicle.

Temperature

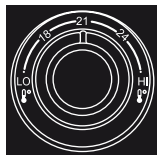

☞ Turn the knob from "LO" (cold) to "HI" (hot) to adjust the temperature to your requirements.

Air distribution



Windscreen and side windows.



Central and side vents.



Footwells.

The air distribution can be adapted by adding the corresponding buttons.

Air intake / Air recirculation

The intake of exterior air avoids misting of the windscreen and side windows.

The recirculation of interior air insulates the passenger compartment from exterior odours and fumes.

i This allows hot or cold air to be delivered quickly when required.



☞ Press this button to recirculate the interior air; its indicator lamp comes on.



☞ Press this button again to allow exterior air into the passenger compartment; its indicator lamp goes off.

i Return to exterior air intake as soon as possible to prevent deterioration of the air quality and the formation of mist.

Air conditioning

With the engine running, the air conditioning is designed to operate effectively in all seasons, with the windows closed.

It enables you to:

- lower the temperature, in summer,
- increase the effectiveness of the demisting in winter, above 3°C.

Switching on

A/C

☞ Press this button; its indicator lamp comes on.

i The air conditioning does not operate when the air flow adjustment is set to off.



To obtain cool air more quickly, you can use interior air recirculation for a few moments. Then return to the intake of exterior air.

Switching off

A/C

☞ Press this button again; its indicator lamp goes off.

! Switching off may result in some discomfort (humidity, misting).

Dual-zone automatic air conditioning



Automatic comfort mode

AUTO

- ☞ Press the "**AUTO**" button repeatedly.

The active mode appears in the display screen, as described below:

**SOFT
AUTO**

- Provides strong and effective air flow.

AUTO

- Offers the best compromise between a comfortable temperature and quiet operation.

**SOFT
AUTO**

- Provides soft and quiet operation by limiting air flow.

i When the engine is cold, the air flow will only reach its optimum level gradually to prevent too great a distribution of cold air.

In cold weather, it favours the distribution of warm air to the windscreen, the side windows and the footwells only.

Manual mode

If desired, you can choose settings different to those offered by the system, by adjusting a setting manually. The other functions are still managed automatically.

The "**AUTO**" symbol disappears if you modify a setting.

Temperature

The driver and front passenger can each set the temperature to suit their requirements. The value indicated in the screen corresponds to a level of comfort and not to a temperature in degrees Celsius or Fahrenheit.

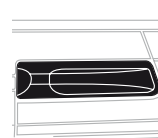

- ☞ Push the button down to reduce the value or up to increase it.

i A setting around 21 enables you to obtain an optimum level of comfort. Depending on your requirements, a setting between 18 and 24 is usual. In addition, it is recommended that you avoid a left/right setting difference of more than 3.

i On entering the vehicle, if the interior temperature is much colder or warmer than the comfort value, there is no need to alter the value displayed in order to obtain the required level of comfort. The system corrects the temperature difference automatically and as quickly as possible.

i For maximum cooling or heating of the passenger compartment, you can exceed the minimum value of 14 or the maximum value of 28.

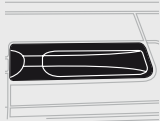

i Push the button down until "LO" is displayed or up until "HI" is displayed.

"Mono" function

The comfort setting for the passenger side can be indexed to the driver's comfort setting (mono-zone).



i Press this button to activate / deactivate the "Mono" function. The indicator lamp in the button is on when the function is activated.

The function is deactivated automatically if a passenger uses the temperature control.

Visibility programme



i Press the "visibility" button for faster demisting or defrosting of the windscreen and side windows.

The system automatically manages the air conditioning, air flow and air intake and distributes the flow of air to the windscreen and side windows to the best effect.



i Press the "visibility" button again to stop the programme.

Or



i Press the "AUTO" button to return to the automatic comfort programme.

Air conditioning

With the engine running, the air conditioning is designed to operate effectively in all seasons, with the windows closed.

It enables you to:

- lower the temperature, in summer,
- increase the effectiveness of the demisting in winter, above 3°C.

Switching on



☞ Press this button; its indicator lamp comes on.

i The air conditioning does not operate when the air flow adjustment is set to off.



To obtain cool air more quickly, you can use interior air recirculation for a few moments. Then return to the intake of exterior air.

Switching off



☞ Press this button again; its indicator lamp goes off.

! Switching off may result in some discomfort (humidity, misting).

Air distribution



☞ Press this button repeatedly to direct the air flow in turn to:

- the windscreen, the side windows and the footwells,
- the footwells,
- the central vents, the side vents and the footwells,
- the windscreen, the side windows, the centre vents and the footwells,
- the centre and side vents,
- the windscreen and side windows (demisting or defrosting).

Air flow



☞ Press this button to increase air flow.



☞ Press this button to decrease air flow.

The air flow symbol (a fan) appears. It is filled in or emptied progressively according to the setting.

Air intake / Air recirculation

The intake of exterior air avoids misting of the windscreen and side windows.

The recirculation of interior air insulates the passenger compartment from exterior odours and smoke.

i This allows hot or cold air to be delivered quickly when required.



☞ Press this button to recirculate the interior air; the symbol appears.



☞ Press this button again to allow exterior air into the passenger compartment; the symbol disappears.

i Return to exterior air intake as soon as possible to avoid deterioration of the air quality and the formation of mist.

Switching the system off



☞ Press this button until the fan symbol disappears.

This action switches off all of the functions of the system.

The temperature is no longer controlled. A slight flow of air, resulting from the movement of the vehicle, remains perceptible however.



Avoid driving for too long with the system switched off (risk of misting and of deterioration of the air quality).



☞ Press this button to switch the system on again.

Front demist - defrost



These markings on the control panel indicate the control positions for rapid demisting or defrosting of the windscreen and side windows.

Manual heating/ventilation or air conditioning

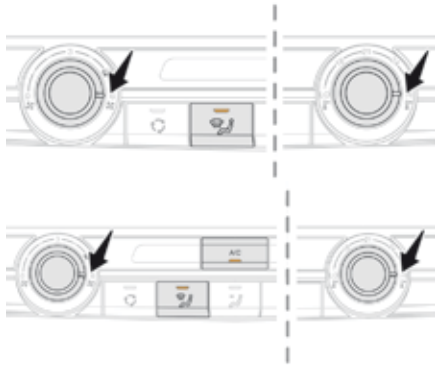

☞ Put the air flow, temperature and distribution controls to the dedicated marked position.

A/C

☞ For air conditioning, press this button; its indicator lamp comes on.

Dual-zone digital air conditioning



☞ Press this button to demist or defrost the windscreen and side windows as quickly as possible.

The system automatically manages the air conditioning, air flow and air intake, and provides optimum distribution towards the windscreen and side windows.



☞ To stop, press this button again or on "AUTO".

AUTO

The system reverts to the previous settings.

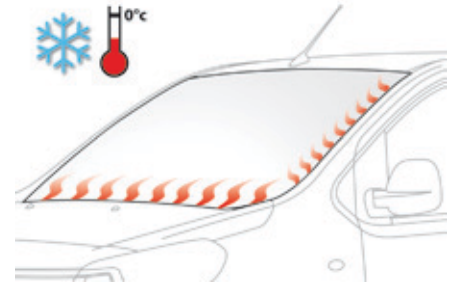

i **Heated windscreen and washer jets**
For more information on the **Wiper control stalk** and in particular the heated windscreen and washer jets, refer to the corresponding section.

i With Stop & Start, when demisting has been activated, the STOP mode is not available.

Door mirrors demist - defrost

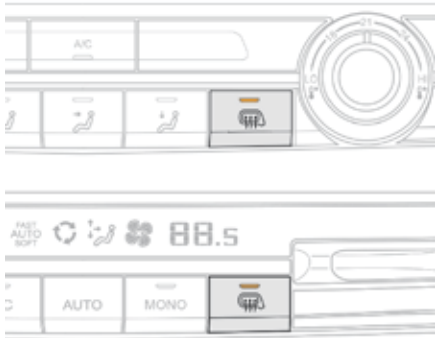

Switching on



☞ Press this button to demist/defrost the door mirrors; its indicator lamp comes on.

Switching off

The demisting/defrosting switches off automatically to prevent an excessive consumption of current.



☞ It is possible to stop the demisting/defrosting operation before it is switched off automatically by pressing this button again; its indicator lamp goes off.



Switch off the heating of the rear screen and door mirrors as soon as you judge it possible, as reducing the consumption of electrical current reduces fuel consumption.



Door mirror demisting and defrosting only operates with the engine running.

Rear screen demist - defrost

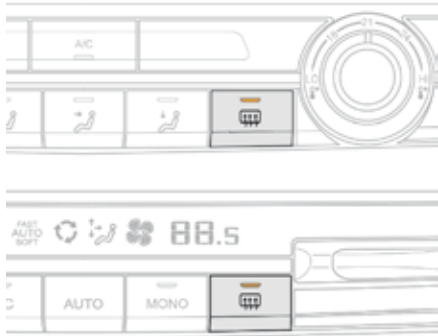

Switching on



Press this button to demist/defrost the rear screen and the door mirrors (if your vehicle is so equipped); its indicator lamp comes on.

Switching off

The demisting/defrosting switches off automatically to prevent an excessive consumption of current.



It is possible to stop the demisting/defrosting operation before it is switched off automatically by pressing this button again; its indicator lamp goes off.



Switch off the heating of the rear screen and door mirrors as soon as you judge it possible, as reducing the consumption of electrical current reduces fuel consumption.



Rear screen demisting and defrosting only operates with the engine running.

Recommendations for heating, ventilation and air conditioning

- i** In order for these systems to be fully effective, follow the operation and maintenance guidelines below:
- ☞ To obtain an even air distribution, take care not to obstruct the exterior air intake grilles located at the base of the windscreen, the nozzles, the vents and the air outlets, as well as the air extractor located at the rear.
 - ☞ Do not cover the sunshine sensor, located at the top of the windscreen; this is used for regulation of the air conditioning system.
 - ☞ Operate the air conditioning system for at least 5 to 10 minutes, once or twice a month to keep it in perfect working order.
 - ☞ Ensure that the passenger compartment filter is in good condition and have the filter elements replaced regularly.
- We recommend the use of a combined passenger compartment filter. Thanks to its special active additive, it contributes to the purification of the air breathed by the occupants and the cleanliness of the passenger compartment (reduction of allergic symptoms, bad odours and greasy deposits).
- ☞ To ensure correct operation of the air conditioning system, you are also advised to have it checked regularly as recommended in the maintenance and warranty guide.
 - ☞ If the system does not produce cold air, switch it off and contact a CITROËN dealer or a qualified workshop.

When towing the maximum load on a steep gradient in high temperatures, switching off the air conditioning increases the available engine power and so improves the towing ability.



Air vents

To close a vent, move the control towards the outside of the vehicle. Slight resistance may be felt.

- ☘** If after an extended stop in sunshine, the interior temperature is very high, first ventilate the passenger compartment for a few moments.
- Put the air flow control at a setting high enough to quickly change the air in the passenger compartment.
- The air conditioning system does not contain chlorine and does not present any danger to the ozone layer.

- i** The condensation created by the air conditioning results in a discharge of water under the vehicle which is perfectly normal.







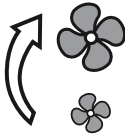
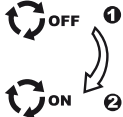

i Stop & Start

The heating and air conditioning systems only work when the engine is running.

To maintain a comfortable temperature in the passenger compartment, you can temporarily deactivate the Stop & Start system.

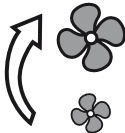
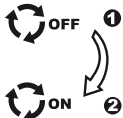
For more information on **Stop & Start**, refer to the corresponding section.

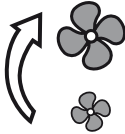
Suggested interior settings

| I require... | Heating or Manual air conditioning | | | | |
|-------------------------|---|---|--|---|---|
| | Air distribution | Air flow | Recirculation of interior air / Intake of exterior air | Temperature | Manual AC |
| HOT |  |  |  |  |  |
| COLD |  |  |  |  | ON |
| DEMISTING DEFROSTING |  |  |  |  | ON |

Dual-zone air conditioning: use the automatic mode in preference by pressing the "AUTO" button.



Rear Heating - Air conditioning

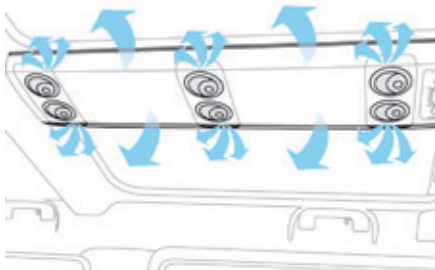
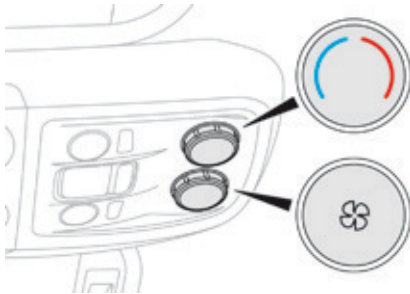

If your vehicle is fitted with a rear air conditioning unit, located in the roof, this system allows the distribution of air conditioned and heated air via ducting and individual outlets.

Activation/Deactivation



This button is accessible from the front, from the air conditioning control panel.



Press this button to enable the rear controls, its indicator lamp comes on.



Press this button again to inhibit the rear controls, its indicator lamp goes off.

Air flow



Turn the knob to increase or decrease the air flow.

Temperature



Turn the knob from blue (cold) to red (hot) to modulate the temperature to your liking.

- i** This control simultaneously adjusts the temperature and the location of the air delivery:
- at blue: the air is delivered mainly at roof level,
 - at red: the air is delivered mainly by the vent located in row 3 on the right.

Programmable Heating / Ventilation

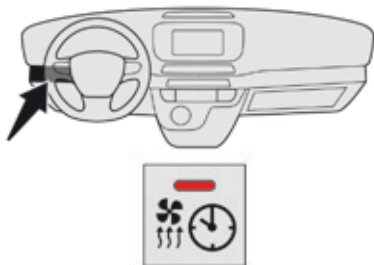

Heating

This is an additional and separate system which heats the engine hot water circuit to heat the passenger compartment and improve defrosting.



This indicator lamp is on when if the system is programmed to come on for heating.

This indicator lamp flashes while the heating is operating.

Ventilation

This system allows ventilation of the passenger compartment to improve the temperature experienced on entering the vehicle in summer.

Programming

Audio system



MENU

☞ Press on the **MENU** button to go to the main menu.

- ☞ Select "**Pre-heat. / Pre-ventil.**".
- ☞ Select "**Activation**" and if necessary for programming, select "**Parameters**".
- ☞ Select "**Heating**" to heat the engine and passenger compartment or "**Ventilation**" to ventilate the passenger compartment.



- ☞ Select:
 - the 1st clock to programme/store your start time,
 - the 2nd clock to programme/store a second start time.

i Using these two clocks and according to season you can, for example, select one or the other start time. A message in the screen confirms your choice.

Long range remote control

The range of the remote control is about 0.6 miles (1 km), in open country.



Switching on



- ☞ Press and hold this button to start the heating immediately.

The indicator lamp in the remote control comes on in green for about 2 seconds to confirm that the signal has been received by the vehicle.

Switching off



- ☞ Press and hold this button to stop the heating immediately.

The indicator lamp in the remote control comes on in red for about 2 seconds to confirm that the signal has been received by the vehicle.

- i The indicator lamp in the remote control flashes for about 2 seconds if the vehicle has not received the signal. You should then move to a different location and repeat the command.

Changing the battery

If the indicator lamp in the remote control becomes orange, the state of charge of the battery is low. If the indicator lamp is not on, the battery is discharged.

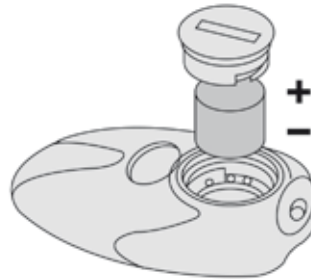

- ☞ Use a coin to unscrew the cap and replace the bulb.



- Do not throw the remote control batteries away, they contain metals which are harmful to the environment. Take them to an approved collection point.

During heating



This indicator lamp flashes while the heating is in operation.

This indicator lamp goes off at the end of the heating cycle or when the heating is stopped using the remote control.



- The maximum heating period is about 45 minutes depending on the ambient conditions.

i The programmable heating system is supplied by the vehicle's fuel tank. Before use, ensure that there is enough fuel in the tank. If the tank is on reserve, it is recommended that the system is not used.

The ventilation is activated provided that the battery is sufficiently charged.

The heating is activated provided that:

- the battery is sufficiently charged,
- the fuel level is adequate,
- the engine has been started since the previous heating cycle.



! Always switch off the programmable heating while refuelling to avoid any risk of fire or explosion.

To avoid the risk of intoxication and asphyxiation, the programmable heating must not be used, even for short periods, in an enclosed area such as a garage or workshop not equipped with exhaust gas extraction.

Do not park the vehicle on an inflammable surface (dry grass, dead leaves, paper...), there is a risk of fire. Glazed surfaces such as the rear screen or windscreen can become very hot in places.

Take care not to place objects in contact with these surfaces, nor touch them with your hands or any other part of your body.



Courtesy lamp(s)

Front



Automatic switching on/off

The front courtesy lamp comes on when the key is removed from the ignition.

All of the courtesy lamps come on when the vehicle is unlocked, when one of the corresponding doors is opened and for location of the vehicle using the remote control.

They switch off gradually after the ignition is switched on and when the vehicle is locked.

Rear



Permanently on, ignition on.



Comes on when one of the front or rear doors is opened.



Permanently off.



Take care to not place anything in contact with the courtesy lamp.



Courtesy lamps

Front



Rear

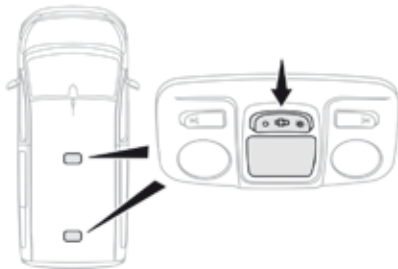

Automatic operation

The front courtesy lamp comes on when the key is removed from the ignition switch. All of the courtesy lamps come on when the vehicle is unlocked, when one of the corresponding doors is opened and for location of the vehicle using the remote control. They go off gradually after the ignition is switched on and when the vehicle is locked.



Front: comes on when one of the front or rear doors is opened (sliding side door and depending on equipment, the left hand side-hinged door or the tailgate).



Permanently on, ignition on.



Row 2 and row 3: comes on when one of the rear doors or the boot is opened (sliding side door and depending on equipment, the left hand side-hinged door or the tailgate).



Permanently off.

Individual reading lamp



If fitted to the vehicle, these are operated by means of a manual switch.

With the ignition on, operate the corresponding switch.



Take care not to leave anything in contact with the courtesy lamp.

Mirrors

Door mirrors

Manual adjustment

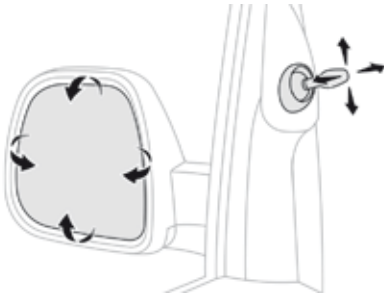

Move the lever in all four directions to adjust. When the vehicle is parked, the door mirrors can be folded back manually.

If the mirror casing has come out of its initial location, with the vehicle stationary, reposition the mirror casing manually or use the electric folding control.

There is no risk of breakage even in the presence of ice.

Electric adjustments

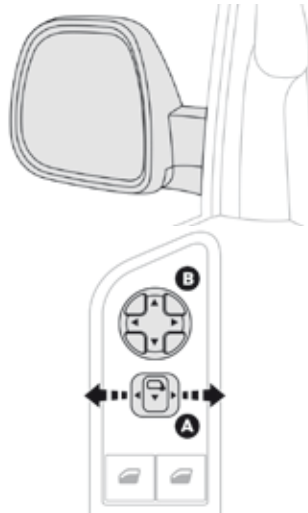

- ☞ Move switch **A** to the right or to the left to select the corresponding mirror.
- ☞ Move knob **B** in all four directions to adjust.
- ☞ Return switch **A** to the centre position.

Electric folding

If your vehicle is fitted with this function, the mirrors can be folded electrically from the inside, with the vehicle parked and the ignition on:



- ☞ Place switch **A** in the centre position.
- ☞ Pull switch **A** rearwards.

From the outside, lock the vehicle using the remote control or the key.

Electric unfolding

The electric unfolding of the mirrors is possible with the remote control or the key on unlocking the vehicle, unless folding was selected using switch **A**. In this case, pull the switch rearwards from the centre position again.

i The folding / unfolding on locking / unlocking can be deactivated. Contact a CITROËN dealer or a qualified workshop.

It is possible to unfold the mirrors manually if necessary.

4

Heated mirrors

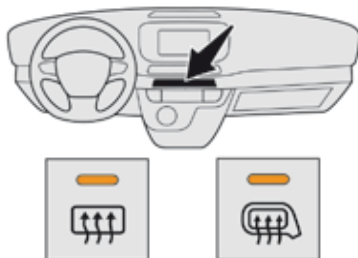

If your vehicle has heated door mirrors:



☞ Press the heated rear window button.

Or



☞ Press the heated mirror button.

i For more information on **Rear screen demist - defrost**, refer to the corresponding section.

! As a safety measure, the mirrors should be adjusted to reduce the blind spots. The objects observed are, in reality, closer than they appear. Take this into account in order to correctly judge the distance of vehicles approaching from behind.

Rear view mirror

Equipped with an anti-dazzle system, which darkens the mirror glass and reduces the nuisance to the driver caused by the sun, headlamps from other vehicles...

Manual model

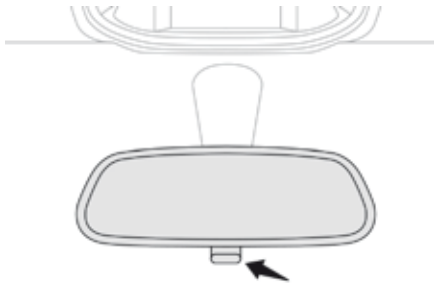

Adjustment

- ☞ Adjust the mirror so that the glass is directed correctly in the "day" position.

Day / night position

- ☞ Pull the lever to change to the "night" anti-dazzle position.
- ☞ Push the lever to change to the normal "day" position.

Automatic "electrochromic" model



This system automatically and progressively changes between the day and night uses by means of a sensor, which measures the light from the rear of the vehicle.

i In order to ensure optimum visibility during your manoeuvres, the mirror lightens automatically when reverse gear is engaged.

Lighting control stalk

Main lighting selection ring



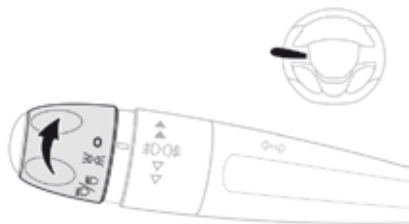

Turn the ring to align the desired symbol with the marking.

Model without AUTO lighting

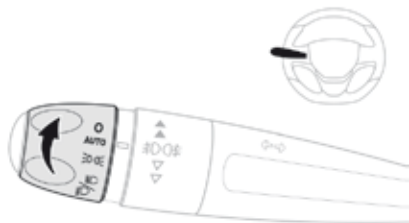

Model with AUTO lighting



-  Lighting off (ignition off) / Front daytime running lamps (engine running).
-  Automatic illumination of headlamps.
-  Sidelamps only.
-  Dipped or main beam headlamps.

i Operation of the selected lighting is confirmed by the illumination of the corresponding indicator lamp.

i In some weather conditions (e.g. low temperature or humidity), the presence of misting on the internal surface of the glass of the headlamps and rear lamps is normal; it disappears after the lamps have been on for a few minutes.

Dipping the headlamps

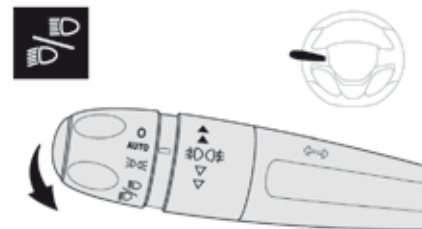

Pull the stalk to switch between dipped and main beam headlamps.

In the lighting off and sidelamps modes, the driver can switch on the main beam headlamps temporarily ("headlamp flash") by maintaining a pull on the stalk.

Foglamp ring

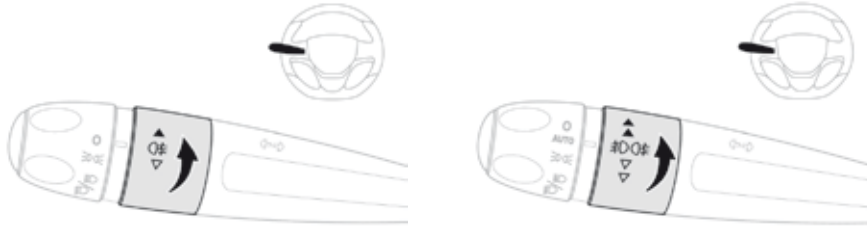

Rear foglamp only

It operates with the sidelamps on.

- ☞ To switch it on, turn the ring forwards.
- When the lighting is switched off automatically (with AUTO model), the foglamp and the dipped beam headlamps will remain on.
- ☞ To switch it off, turn the ring rearwards.



Front and rear foglamps

They operate with dipped beam headlamps on, in manual or auto mode.

Rotate and release the ring:

- ☞ forwards once to switch on the front foglamps,
- ☞ forwards again to switch on the rear foglamps,
- ☞ rearwards once to switch off the rear foglamps,
- ☞ rearwards again to switch off the front fog lamps.

When the headlamps switch off with automatic illumination of headlamps (AUTO model) or when the dipped beam headlamps are switched off manually, the foglamps and sidelamps remain on.

- ☞ Turn the ring rearwards to switch off the foglamps, the sidelamps will then switch off.

i Lighting left on audible signal

An audible signal when a front door is opened warns the driver that the vehicle's exterior lighting is on, with the ignition off and in manual lighting mode. In this case, switching off the lighting stops the audible signal.

The lighting goes off when you switch off the ignition, but you can always switch it on again using the lighting control stalk.

i Travelling abroad

If using your vehicle in a country that drives on the other side of the road, the headlamps must be adjusted to avoid dazzling on-coming drivers. Contact a CITROËN dealer or a qualified workshop.

! In good or rainy weather, both day and night, the front foglamps and the rear foglamps are prohibited. In these situations, the power of their beams may dazzle other drivers. They should only be used in fog or snow. In these weather conditions, it is your responsibility to switch on the foglamps and dipped headlamps manually as the sunshine sensor may detect sufficient light.

Do not forget to switch off the front foglamps and the rear foglamps when they are no longer needed.

Direction indicators

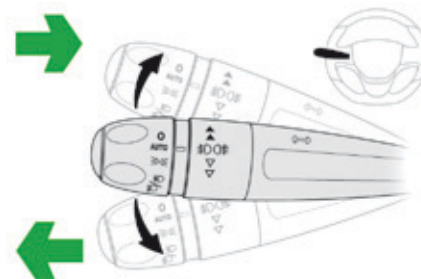

- ☞ Left: lower the lighting stalk, passing the point of resistance.
- ☞ Right: raise the lighting stalk, passing the point of resistance.

Three flashes of the direction indicators

- ☞ Press briefly upwards or downwards, without going beyond the point of resistance; the direction indicators will flash 3 times.

Front daytime running lamps (light-emitting diodes)

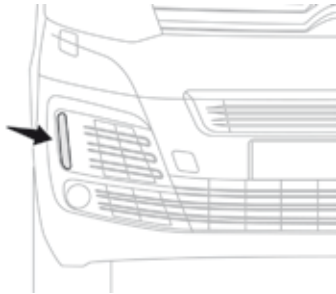

They come on automatically when the engine is started, when the lighting control stalk is in position "0" or "AUTO".

Automatic illumination of headlamps

When a low level of ambient light is detected by a sunshine sensor, the number plate lamps, sidelamps and dipped beam headlamps are switched on automatically, without any action on the part of the driver. They can also come on if rain is detected, at the same time as automatic operation of the windscreen wipers. As soon as the brightness returns to a sufficient level or after the windscreen wipers are switched off, the lamps are switched off automatically.

Activation

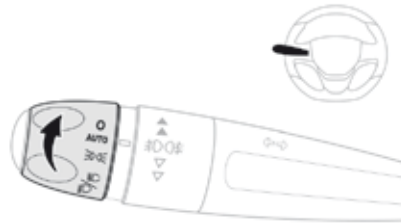

- ☞ Turn the ring to the "AUTO" position. The activation of the function is accompanied by the display of a message.

Deactivation

- ☞ Turn the ring to another position. Deactivation of the function is accompanied by the display of a message.

Operating fault

SERVICE In the event of a malfunction of the sunshine sensor, the lighting comes on; this warning lamp is displayed in the instrument panel accompanied by an audible signal and/or a message. Contact a CITROËN dealer or a qualified workshop.

! In fog or snow, the sunshine sensor may detect sufficient light. In this case, the lighting will not come on automatically. Do not cover the sunshine sensor, coupled with the rain sensor and located in the top of the windscreen behind the rear view mirror; the associated functions would no longer be controlled.

4

Manual guide-me-home lighting

Temporarily keeping the dipped beam headlamps on after the vehicle's ignition has been switched off makes the driver's exit easier when the light is poor.

Switching on

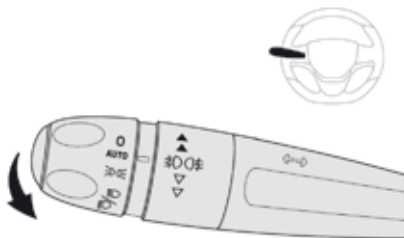

- ☞ With the ignition off, "flash" the headlamps using the lighting stalk.
- ☞ A further "headlamp flash" switches the function off.

Switching off

The manual guide-me-home lighting switches off automatically after a set time.

Automatic guide-me-home lighting

When the automatic illumination of headlamps function is activated, under low ambient light the dipped beam headlamps come on automatically when the ignition is switched off.

Programming

The activation, deactivation and selection of period the guide-me-home lighting is kept on can be set.

With the audio system



In the "**Personalisation-configuration**" menu, activate/deactivate "**Follow-me-home headlamps**".

With the touch screen



In the vehicle settings menu, activate/deactivate "**Guide-me-home lighting**".

Exterior welcome lighting

The remote switching on of the lighting makes your approach to the vehicle easier in poor light. It is activated when the lighting control is in the "AUTO" position and the level of light detected by the sunshine sensor is low.

Switching on



☞ Press the open padlock on the remote control or one of the front door handles with Keyless Entry and Starting.

The dipped beam headlamps and sidelamps come on; your vehicle is also unlocked.

Switching off

The exterior welcome lighting switches off automatically after a set time, when the ignition is switched on or on locking the vehicle.

Programming

The activation, deactivation and choice of welcome lighting duration can be set.

With the audio system



In the "Personalisation-configuration" menu, activate/deactivate "Welcome lighting".

With the touch screen



In the vehicle settings menu, activate/deactivate "Welcome lighting".

Cornering lighting

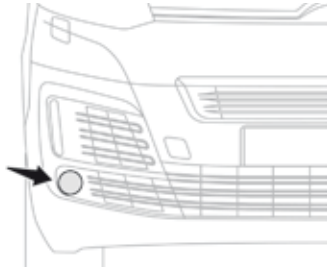

With dipped or main beams, this function makes use of the beam from a front foglamp to illuminate the inside of a bend, when the vehicle speed is below 25 mph (40 km/h) (urban driving, winding road, intersections, parking manoeuvres...).

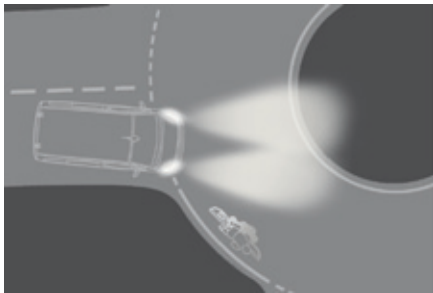

Without cornering lighting

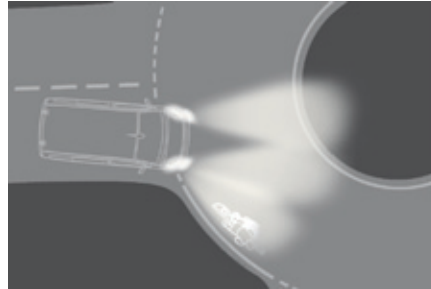

With cornering lighting

Switching on

The system operates:

- when the corresponding direction indicator is switched on,
- or
- from a certain angle of rotation of the steering wheel.

Switching off

The system does not operate:

- below a certain angle of rotation of the steering wheel,
- above 25 mph (40 km/h),
- when reverse gear is engaged.

Programming

The system is activated or deactivated in the vehicle configuration menu. The system is activated by default.

With the audio system



In the **"Personalisation-configuration"** menu, activate/deactivate **"Driving lighting"**.

With the touch screen



In the vehicle settings menu, activate/deactivate **"Driving lighting"**.

Automatic headlamp dipping

System which automatically changes between dipped and main beam according to the ambient light level and the driving conditions, using a camera located at the top of the windscreen.



i The driver can intervene at any time if the circumstances dictate by pulling on the lighting control stalk to switch between main and dipped beam.

i Flashing the headlamps does not deactivate the system. The state of the system stays in memory when the ignition is switched off.

! This automatic headlamp dipping system is a driving aid. The driver remains responsible for the vehicle's lighting and for adapting its settings to the levels of brightness and visibility and the traffic conditions.

i The system will be operational as soon as you have exceeded 15 mph (25 km/h). If the speed drops below 9 mph (15 km/h), the system no longer operates.

Activation / deactivation

☞ Put the lighting control stalk ring in the "AUTO" or dipped/main beam position.

Pause

The driver can intervene at any time if the situation requires a change in the state of the headlamps.



☞ Flashing the headlamps pauses the function and the lighting system changes to "automatic illumination of headlamps".

4

With / Without audio system

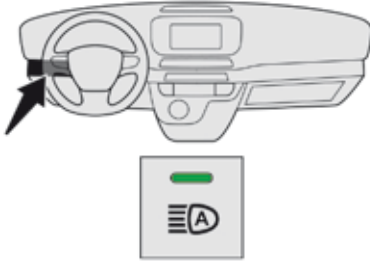

To activate the system:



☞ Press on this button, its indicator lamp comes on, the system is activated.

To deactivate the system:



☞ Press on this button, its indicator lamp goes off, the system is deactivated.

With the touch screen



In the **Driving** menu, activate/deactivate "Automatic headlamp dip".

i The system may suffer interference or not work correctly:

- under conditions of poor visibility (for example, snowfall, heavy rain or thick fog...),
- if the windscreen is dirty, misted or obscured (by a sticker...) in front of the camera,
- if the vehicle is facing highly reflective signs.

If the fog is too dense, the system is automatically deactivated.

The system is not able to detect:

- road users that do not have their own lighting, such as pedestrians,
- road users whose lighting is obscured, such as vehicles running behind a safety barrier (on a motorway, for example),
- road users at the top or bottom of a steep slope, on twisty roads, on crossroads.

Manual headlamp beam height adjustment

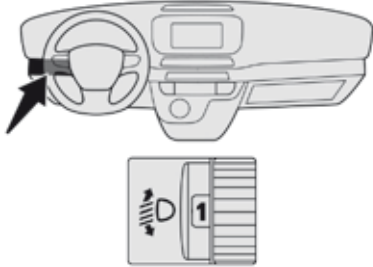

To avoid causing a nuisance to other road users, the beams of the halogen headlamps should be adjusted according to the load in the vehicle.

- 0 Unladen.
- 1 Part load.
- 2 Medium load.
- 3 Maximum authorised load.

i The initial setting is position "0".



To avoid causing a nuisance to other road users, the beams of the halogen headlamps should be adjusted according to the load in the vehicle.

- 0 - 1 or 2 people in the front seats.
- 1 - 5 people.
- 2 - 6 to 9 people.
- 3 - Driver + maximum authorised loads.

i The initial setting is position "0".

Wiper control stalk

Programming

Your vehicle may also include some functions that can be configured:

- automatic rain sensitive windscreen wipers,
- rear wiping on engaging reverse gear.

i In wintry conditions, remove snow, ice or frost present on the windscreen, around the wiper arms and blades and the windscreen seal, before operating the wipers.

! Do not operate the wipers on a dry windscreen. Under extremely hot or cold conditions, ensure that the wiper blades are not stuck to the windscreen before operating the wipers.

Manual controls

The wipers are controlled directly by the driver.

Model with manual wiping (intermittent)

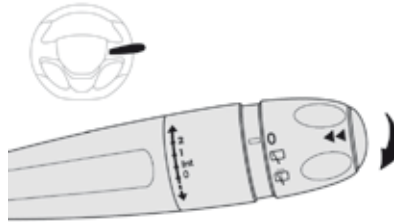

Model with AUTO wiping

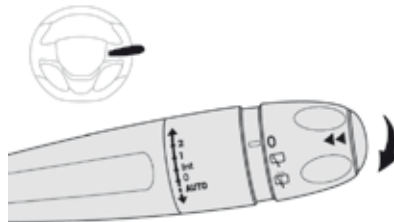

Windscreen wipers

Wiping speed control stalk: raise or lower the stalk to the desired position.

2

Fast wipe (heavy rain).

1

Normal wipe (moderate rain).

Int

Intermittent wipe (proportional to the speed of the vehicle).

0

Park.



Single wipe (press downwards or pull the stalk briefly towards you, then release).

Or

AUTO

Automatic wiping (press down, then release).
Single wipe (pull the stalk briefly towards you).

Automatic rain sensitive windscreen wipers

The windscreen wipers operate automatically, without any action on the part of the driver, if rain is detected (sensor behind the rear view mirror), adapting their speed to the intensity of the rainfall.

Switching on

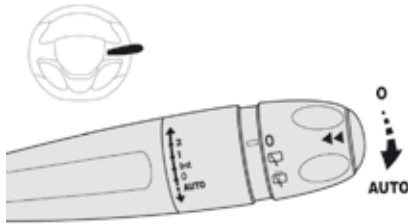

Briefly push the control stalk downwards. A wiping cycle confirms that the instruction has been accepted. This warning lamp comes on in the instrument panel and a message is displayed.

Switching off



Briefly push the control stalk downwards again, or place the control stalk in another position (Int, 1 or 2). This warning lamp goes off in the instrument panel and a message is displayed.

i The automatic rain sensitive windscreen wipers must be reactivated by pushing the control stalk downwards, if the ignition has been off for more than one minute.

Operating fault

If a fault occurs with the automatic rain sensitive wipers, the wipers will operate in intermittent mode. Have it checked by CITROËN dealer or a qualified workshop.

! Do not cover the rain sensor, linked with the sunshine sensor and located in the top of the windscreen behind the rear view mirror. Switch off the automatic rain sensitive wipers when using an automatic car wash. In winter, it is advisable to wait until the windscreen is completely clear of ice before activating the automatic rain sensitive wipers.

Rear wiper

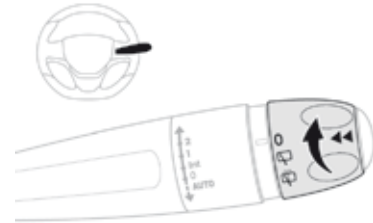

4



Park.



Intermittent wipe.



Wash-wipe (set duration).

Reverse gear

When reverse gear is engaged, the rear wiper will come into operation automatically if the windscreen wipers are operating.

Activation / Deactivation

Activation or deactivation of the function is done in the vehicle configuration menu.

i This function is activated by default.

! If a significant accumulation of snow or ice is present, or when using a bicycle carrier on the boot, deactivate the automatic rear wiper.

With the audio system



In the "**Personalisation-configuration**" menu, activate/deactivate "**Rear wipe in reverse gear**".

With the touch screen



In the vehicle settings menu, activate/deactivate "**Rear wiper in reverse**".

Windscreen and headlamp wash

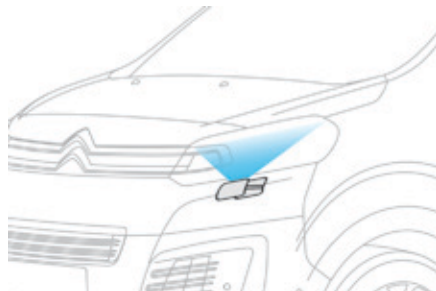

☞ Pull the windscreen wiper stalk towards you. The screenwash then the wipers operate for a fixed period.

The headlamp wash is only activated **if the dipped headlamps are on** and the vehicle is **moving**.

With daytime running lamps, to activate the headlamp wash, position the lighting stalk in the dipped beam position.

i On vehicles fitted with automatic air conditioning, any action on the windscreen wash control results in temporary closing of the air intake to avoid odours inside the passenger compartment.

Screenwash/headlamp wash level low

SERVICE In the case of vehicles fitted with headlamp washers, when the fluid reservoir low level is reached this warning lamp comes on in the instrument panel, accompanied by an audible signal and a message.

The warning lamp comes on when the ignition is switched on, or every time the stalk is operated, until the reservoir is refilled. Next time you stop, refill the screenwash / headlamp wash reservoir.

Heated windscreen and washer jets*

This function heats the windscreen and washer jets under cold conditions.

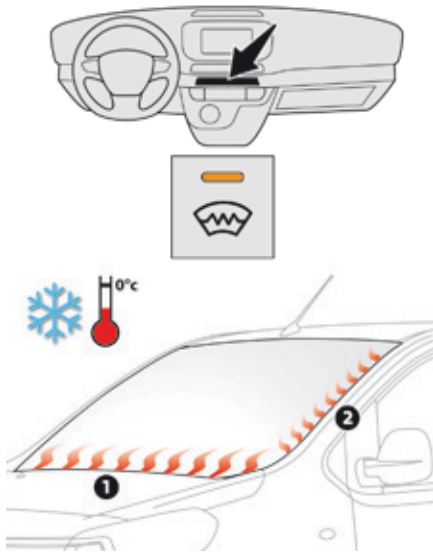

In area 1, the heating frees the wiper blades when they are stuck by snow or ice.

In area 2, the heating improves visibility by avoiding the accumulation of snow when the wipers are operating.

* Depending on the country of sale.

Switching on



With the engine running, press this button; its indicator lamp comes on.

The period of operation depends on the ambient temperature.

Pressing this button again switches the function off; its indicator lamp goes off.

Special position of the windscreen wipers

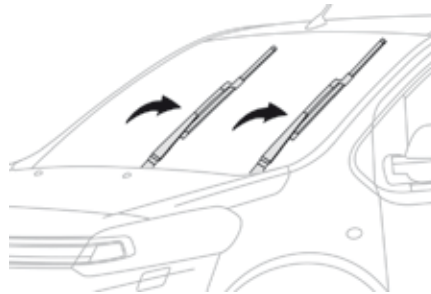

This position permits release of the windscreen wiper blades.

It is used for cleaning or replacement of the wiper blades. It can also be useful, in winter, to release the wiper blades from the windscreen.

- ☞ Any action on the wiper stalk within one minute after switching off the ignition places the wiper blades vertically on the screen.
- ☞ To park the wiper blades again, switch on the ignition and operate the wiper stalk.

i To maintain the effectiveness of the wiper blades, it is advisable to:

- handle them with care,
- clean them regularly using soapy water,
- avoid using them to retain cardboard on the windscreen,
- replace them at the first signs of wear.

4

Hazard warning lamps

Visual warning with all of the direction indicators flashing to alert other road users to a vehicle breakdown, towing or accident.

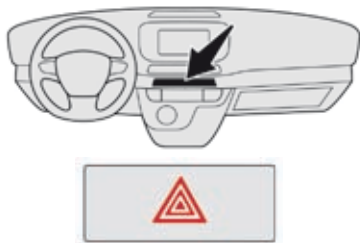

- ☞ Press this button, all of the direction indicators flash. They can operate with the ignition off.

Automatic operation of hazard warning lamps

When braking in an emergency, depending on the rate of deceleration, as well as when the ABS regulation is invoked or in the event of an impact, the hazard warning lamps come on automatically.

They switch off automatically the first time you accelerate.

- ☞ You can also switch them off by pressing the button.

Emergency or assistance call

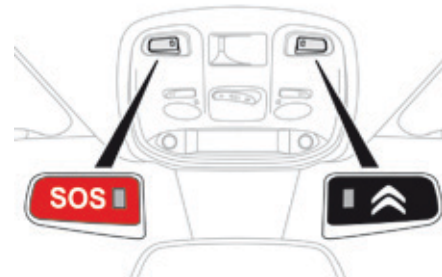

This system allows you to make an emergency or assistance call to the emergency services or to the dedicated CITROËN service.

i For more information on **Audio and telematics** and in particular the use of this equipment, refer to the corresponding section.

Horn



- ☞ Press the central part of the steering wheel.

Electronic stability control (ESC)

Electronic stability control (ESC) incorporating the following systems:

- anti-lock braking system (ABS) and electronic brake force distribution (EBFD),
- emergency braking assistance (EBA),
- wheel anti-slip regulation (ASR) or traction control,
- dynamic stability control (DSC).

Definitions

Anti-lock braking system (ABS) and electronic brake force distribution (EBFD)

This system improves the stability and manoeuvrability of your vehicle when braking and contributes towards improved control on corners, in particular on poor or slippery road surfaces.

The ABS prevents wheel lock in the event of emergency braking.

The EBFD manages the braking pressure wheel by wheel.

Emergency braking assistance (EBA)

In an emergency, this system enables you to reach the optimum braking pressure more quickly and therefore reduce the stopping distance.

It is triggered according to the speed at which the brake pedal is pressed. This is felt by a reduction in the resistance of the pedal and an increase in the effectiveness of the braking.

Anti-slip regulation (ASR)

The ASR system (also known as Traction Control) optimises traction in order to limit wheel slip by acting on the brakes of the driving wheels and on the engine. It also improves the directional stability of the vehicle on acceleration.

Dynamic stability control (DSC)

If there is a difference between the path followed by the vehicle and that required by the driver, the DSC monitors each wheel and automatically acts on the brake of one or more wheels and on the engine to return the vehicle to the required path, within the limits of the laws of physics.

Intelligent traction control

If fitted to your vehicle, it has a system to help driving on snow: **intelligent traction control**. This system detects situations of difficult surface adhesion that could make it difficult to move off or make progress on deep fresh snow or compacted snow.

In these situations, **intelligent traction control** limits the amount of wheel slip to provide the best traction and trajectory control for your vehicle.

i The use of snow tyres is strongly recommended on surfaces offering low levels of grip.

Anti-lock braking system (ABS) and electronic brake force distribution (EBFD)



The fixed illumination of this warning lamp indicates that there is a fault with the ABS.

The vehicle retains conventional braking. Drive carefully at moderate speed.



STOP



When this warning lamp comes on, coupled with the **STOP** and ABS warning lamps, accompanied by an audible signal and a message, it indicates that there is a fault with the electronic brake force distribution (EBFD).

You must stop as soon as it is safe to do so.

In both cases, have the system checked by a CITROËN dealer or a qualified workshop as soon as possible.

i When changing wheels (tyres and rims), ensure that these are approved for your vehicle. Normal operation of the ABS may make itself felt by slight vibrations of the brake pedal.

! **In emergency braking, press very firmly and maintain this pressure.**

Dynamic stability control (DSC) and anti-slip regulation (ASR)

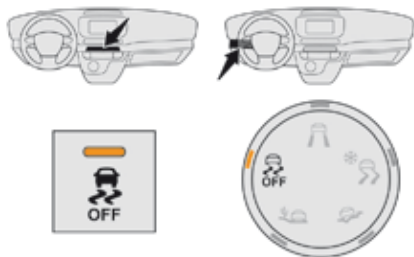

Activation

These systems are activated automatically each time the vehicle is started. As soon as they detect a problem of grip or trajectory, these systems act on the operation of the engine and brakes.



This is indicated by flashing of this warning lamp in the instrument panel.

Deactivation

In exceptional conditions (starting a vehicle which is bogged down, stuck in snow, on soft ground...), it may be advisable to deactivate the DSC system, so that the wheels can move freely and regain grip.

But it is recommended that the system be reactivated as soon as possible.



☞ Press this button.

Or



☞ Turn the knob to this position.

The indicator lamp in the button or the knob comes on: the DSC system no longer acts on the operation of the engine.

Reactivation

The system is reactivated automatically each time the ignition is switched back on or from 30 mph (50 km/h). However, below 30 mph (50 km/h) you can manually reactivate the system.



☞ Press this button.

Or



☞ Turn the knob to this position.

The indicator lamp in the button or the knob goes off.

Operating fault



If this warning lamp comes on, accompanied by an audible signal and a message in the screen, this indicates a fault with the system.

Contact a CITROËN dealer or a qualified workshop to have the system checked.



The DSC system offers exceptional safety in normal driving, but this should not encourage the driver to take extra risks or drive at high speed.

The correct operation of the system depends on observation of the manufacturer's recommendations regarding the wheels (tyres and rims), the braking components, the electronic components and the CITROËN assembly and repair procedures. After an impact, have the system checked by a CITROËN dealer or a qualified workshop.

Grip control

Special patented traction control system which improves traction on snow, mud and sand.

This system, the operation of which has been optimised for each situation, allows you to manoeuvre in most conditions of poor grip (encountered during touring use).

The accelerator pedal should be pressed sufficiently to allow the system to use the power of the engine. Operation at high engine speeds is completely normal.

A five-position selector knob allows you to choose the setting best suited to the driving conditions encountered.

An indicator lamp associated with each mode comes on to confirm your choice.

i Associated with all-seasons Peak Mountain Snow Flake tyres, this system offers a compromise between safety, adhesion and traction. These tyres work equally well in winter and summer.

Different modes are provided:

Standard (ESC)

This mode is calibrated for a low level of wheel spin, based on the different levels of grip normally encountered on the road.

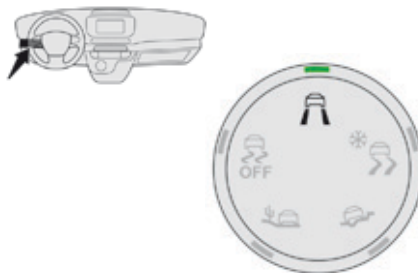

☞ Place the knob in this position.

i Every time the ignition is switched off, the system automatically resets to this mode.

Snow

This mode adapts its strategy to the conditions of grip encountered for each of the two front wheels on moving off. (mode active up to 30 mph (50 km/h))

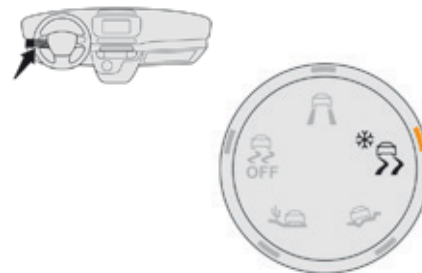

☞ Place the knob in this position.

All terrain (mud, damp grass, ...)

This mode, when moving off, allows considerable spin on the wheel with the least grip to optimise clearing of the mud and regain grip. At the same time, the wheel with the most grip is controlled in such a way as to transmit as much torque as possible.

When moving, the system optimises wheel spin to respond to the driver's requirements as fully as possible.

(mode active up to 50 mph (80 km/h))



☞ Place the knob in this position.

Sand

This mode allows little spin on the two driving wheels at the same time to allow the vehicle to move forward and limit the risks of getting stuck in the sand.

(mode active up to 75 mph (120 km/h))



☞ Place the knob in this position.

Do not use the other modes on sand as the vehicle may become stuck.

You can deactivate certain functions of the ESC (ASR and DSC) by turning the knob to the "OFF" position.

These functions are reactivated automatically from 30 mph (50 km/h) or every time the ignition is switched back on.

i Driving advice

Your vehicle is designed principally to drive on tarmac roads but it allows you to drive on other less passable terrain occasionally.

However, it does not permit off-road driving such as:

- crossing and driving on terrain which could damage the underbody or strip away components (fuel pipe, fuel cooler...) due to obstacles or stones in particular,
- driving on terrain with steep gradients and poor grip,
- crossing a stream.

Seat belts

Front seat belts



The front seat belts are fitted with a pretensioning and force limiting system. This system improves safety in the front seats in the event of a front or side impact. Depending on the severity of the impact, the pretensioning system instantly tightens the seat belts against the body of the occupants.

The pretensioning seat belts are active when the ignition is on.

The force limiter reduces the pressure of the seat belt on the chest of the occupant, so improving their protection.

Fastening

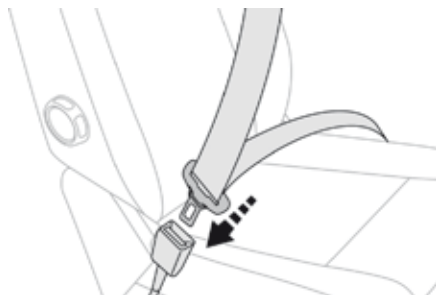

- ☞ Pull the strap, then insert the tongue in the buckle.
- ☞ Check that the seat belt is fastened correctly by pulling the strap.

Unfastening

- ☞ Press the red button on the buckle.
- ☞ Guide the seat belt as it reels in.

Height adjustment

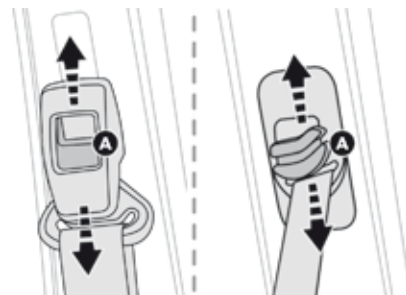

- ☞ To lower the attachment point, while moving control **A** downwards, slide the assembly down to the desired position.
- ☞ To raise the attachment point, slide the assembly up to the desired position.

i The upper part of the diagonal strap should lie across the shoulder.

2 seat front bench seat

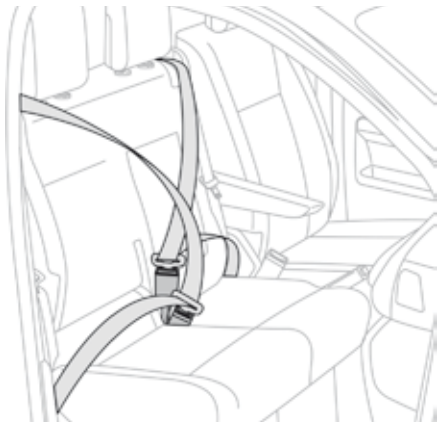

If your vehicle is fitted with a front bench seat, ensure that each belt is used with its correct buckle.

Do not interchange the driver's seat belt or buckle with the centre seat belt or buckle.

Rear seat belts

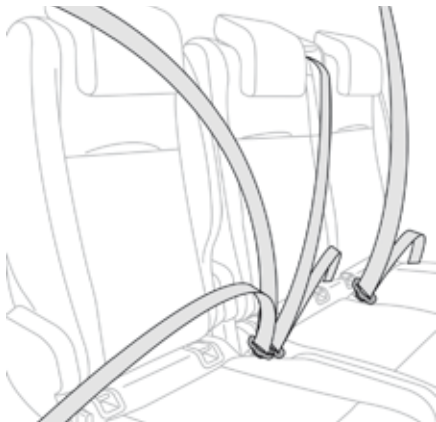

If your vehicle is fitted with a 3-seat bench seat (one piece or 1/3 - 2/3 split), these are fitted with three-point seat belts and inertia reels on the outer seats.

And the centre seat has its own guide and reel, built into the seat backrest.

The seat belt reels for the outer seats in row 2 have force limiters.

The seats in row 3 have three-point seat belts with inertia reels.

i For rows 2 and 3, fit each seat belt to its correct buckle.

Do not interchange the belts or buckles for the outer seats with the belt or buckle for the centre seat.

When folding the outer seats or placing a backrest in the table position, avoid trapping the belt for the centre seat.

After folding a rear seat or bench seat, ensure that the seat belt has reeled in correctly and the buckle is ready to receive the belt tongue.

When handling the outer seats (removing or refitting) or for access to row 3, avoid trapping the centre belt.

Seat belt warning lamps



If your vehicle has individual front seats:

1. Driver's seat belt not fastened / unfastened warning lamp in the instrument panel.
2. Front passenger seat belt not fastened / unfastened warning lamp.

On switching on the ignition, a warning lamp comes on in the instrument panel if the corresponding seat belt is not fastened or is unfastened.



From about 12 mph (20 km/h) and for two minutes, the warning lamp(s) flash accompanied by an audible signal. Beyond these two minutes,



the warning lamps remain on if the driver or front passenger do not fasten their seat belt(s).

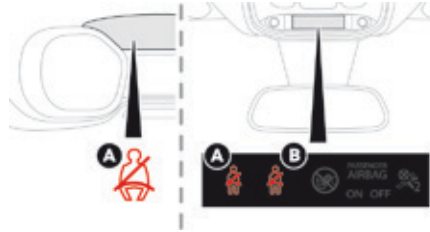

If your vehicle has a 2-seat bench front seat:

- A. Outer left (driver) seat belt not fastened / unfastened warning lamp.
- B. Centre and/or outer seat belt not fastened warning lamp.

When the ignition is switched on, the warning lamp **A** comes on if the driver's seat belt is not fastened or unfastened.

The warning lamp **B** comes on if the centre and/or an outer seat belt is unfastened.

i Advice

The driver must ensure that passengers use the seat belts correctly and that they are all fastened before setting off.

Wherever you are seated in the vehicle, always fasten your seat belt, even for short journeys.

Do not interchange the seat belt buckles as they will not fulfill their role fully.

The seat belts are fitted with an inertia reel permitting automatic adjustment of the length of the strap to your size. The seat belt is stowed automatically when not in use.

Before and after use, ensure that the seat belt is reeled in correctly.

The lower part of the strap must be positioned as low as possible on the pelvis. The upper part must be positioned in the hollow of the shoulder.

The inertia reels are fitted with an automatic locking device which comes into operation in the event of a collision, emergency braking or if the vehicle rolls over. You can release the device by pulling the strap firmly and then releasing it so that it reels in slightly.

In order to be effective, a seat belt must:

- be tightened as close to the body as possible,
- be pulled in front of you with a smooth movement, checking that it does not twist,
- be used to restrain only one person,
- not bear any trace of cuts or fraying,
- not be converted or modified to avoid affecting its performance.

In accordance with current safety regulations, for all repairs on your vehicle's seat belts, go to a qualified workshop with the skills and equipment needed, which a CITROËN dealer is able to provide.

Have your seat belts checked regularly by a CITROËN dealer or a qualified workshop, particularly if the straps show signs of damage.

Clean the seat belt straps with soapy water or a textile cleaning product, sold by CITROËN dealers.

After folding or moving a seat or rear bench seat, ensure that the seat belt is positioned and reeled in correctly.

Recommendations for children

Use a suitable child seat if the passenger is less than 12 years old or shorter than one and a half metres.

Never use the same seat belt to secure more than one person.

Never allow a child to travel on your lap.

For more information on **Child seats**, refer to the corresponding section.

5

In the event of an impact

Depending on the nature and seriousness of the impact, the pretensioning device may be deployed before and independently of the airbags. Deployment of the pretensioners is accompanied by a slight discharge of harmless smoke and a noise, due to the activation of the pyrotechnic cartridge incorporated in the system.

In all cases, the airbag warning lamp comes on.

Following an impact, have the seat belts system checked, and if necessary replaced, by a CITROËN dealer or a qualified workshop.

Airbags

System designed to contribute towards improving the safety of the occupants (with the exception of the centre seat in rows 2 and 3, if so equipped) in the event of violent collisions. The airbags supplement the action of the seat belts fitted with force limiters.

If a collision occurs, the electronic detectors record and analyse the front and side impacts sustained in the impact detection zones:

- in the case of a serious impact, the airbags are deployed instantly and contribute towards better protection of the occupants of the vehicle (with the exception of the centre seat in rows 2 and 3, if so equipped); immediately after the impact, the airbags deflate rapidly so that they do not hinder visibility or the exit of the occupants,
- in the case of a minor or rear impact or in certain roll-over conditions, the airbags may not be deployed; the seat belt alone contributes towards ensuring your protection in these situations.

! The airbags do not operate when the ignition is switched off.

This equipment will only deploy once. If a second impact occurs (during the same or a subsequent accident), the airbag will not be deployed again.

i Deployment of one or more of the airbags is accompanied by a slight emission of smoke and a noise, due to the activation of the pyrotechnic cartridge incorporated in the system. This smoke is not harmful, but sensitive individuals may experience slight irritation.

The noise of detonation related to the deployment of one or more airbags may result in a slight loss of hearing for a short time.

Impact detection zones

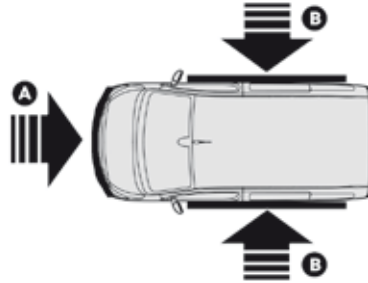

- A. Front impact zone.
- B. Side impact zone.

Front airbags

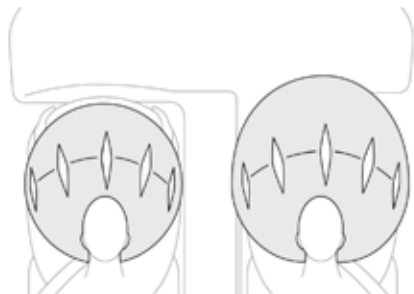

System which protects the driver and passenger(s) in the event of a serious front impact in order to limit the risk of injury to the head and thorax.

The driver's airbag is fitted in the centre of the steering wheel; the front passenger airbag is fitted in the dashboard above the glove box.

Deployment

The airbags are deployed, except the passenger front airbag if it is deactivated, in the event of a serious front impact to all or part of the front impact zone **A**, in the longitudinal centreline of the vehicle on a horizontal plane and directed from the front to the rear of the vehicle.

The front airbag inflates between the thorax and head of the front occupant of the vehicle and the steering wheel, driver's side, and the dashboard, passenger side to cushion their forward movement.

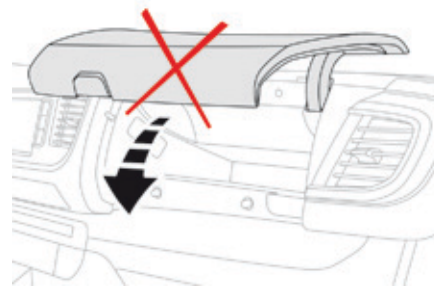

! **When driving**, keep the glove box closed. Otherwise there is a risk of injury in the event of an accident or sudden braking.

5

Deactivating the passenger front airbag

Only the passenger front airbag can be deactivated.

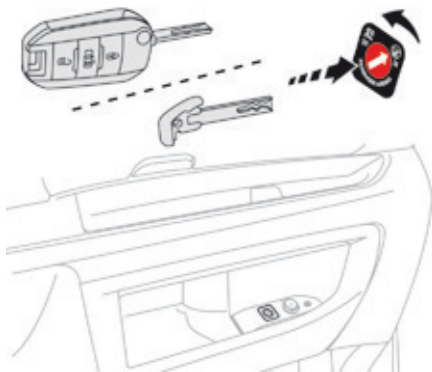

- ☞ **With the ignition off**, insert the key in the passenger airbag deactivation switch.
- ☞ Turn it to the **"OFF"** position.
- ☞ Remove the key keeping the switch in the new position.



When the ignition is on, this warning lamp comes in the seat belt warning display screen. It stays on while the airbag is deactivated.

! To assure the safety of your child, the passenger front airbag must be deactivated when you install a rearward facing child seat on the front passenger seat. Otherwise, the child would risk being seriously injured or killed if the airbag were deployed.

Reactivating the passenger front airbag

When you remove the child seat, **with the ignition off**, turn the switch to the **"ON"** position to reactivate the airbag and so assure the safety of your front passenger(s) in the event of an impact.



When the ignition is switched on, this warning lamp comes on in the seat belt warning display screen for approximately one minute to signal that the front airbag is activated.

Operating fault



If this warning lamp comes on in the instrument panel, you must contact a CITROËN dealer or a qualified workshop to have the system checked. The airbags may no longer be deployed in the event of a serious impact.

Lateral airbags



If fitted to your vehicle, this is a system which protects the driver and front passenger in the event of a serious side impact in order to limit the risk of injury to the chest, between the abdomen and head.

Each lateral airbag is fitted in the seat backrest frame, door side.

Deployment

The lateral airbags are deployed unilaterally in the event of a serious side impact applied to all or part of the side impact zone, perpendicular to the longitudinal centreline of the vehicle on a horizontal plane and directed from the outside towards the inside of the vehicle.

The lateral airbag inflates between the abdomen and head of the front occupant of the vehicle and the corresponding door trim panel.

! Advice

For the airbags to be fully effective, observe the safety recommendations below:

Sit in a normal upright position.

Wear a correctly adjusted seat belt.

Do not leave anything between the occupants and the airbags (a child, pet, object...), nor fix or attach anything close to the inflation trajectory of the airbags; this could cause injuries during their deployment.

Never modify the original definition of your vehicle, particularly in the area directly around the airbags.

After an accident or if the vehicle has been stolen or broken into, have the airbag systems checked.

All work on the airbag system must be carried out by a CITROËN dealer or a qualified workshop.

Even if all of the precautions mentioned are observed, a risk of injury or of minor burns to the head, chest or arms when an airbag is deployed cannot be ruled out.

The bag inflates almost instantly (within a few milliseconds) then deflates within the same time discharging the hot gas via openings provided for this purpose.

Front airbags

Do not drive holding the steering wheel by its spokes or resting your hands on the centre part of the wheel.

Passengers must not place their feet on the dashboard.

Do not smoke as deployment of the airbags can cause burns or the risk of injury from a cigarette or pipe.

Never remove or pierce the steering wheel or hit it violently.

Do not fit or attach anything to the steering wheel or dashboard, this could cause injuries with deployment of the airbags.

Lateral airbags

Use only approved covers on the seats, compatible with the deployment of the lateral airbags. For information on the range of seat covers suitable for your vehicle, you can contact a CITROËN dealer.

For more information on **Accessories**, refer to the corresponding section.

Do not fix or attach anything to the seat backs (clothing...). This could cause injury to the chest or arms if the lateral airbag is deployed.

Do not sit with the upper part of the body any nearer to the door than necessary.

The vehicle's front door panels include side impact sensors.

A damaged door or any unauthorised or incorrectly executed work (modification or repair) on the front doors or their interior trim could compromise the operation of these sensors - Risk of malfunction of the lateral airbags!

Such work must only be done by a CITROËN dealer or a qualified workshop.

General points relating to child seats

Although one of CITROËN's main criteria when designing your vehicle, the safety of your children also depends on you.

For maximum safety, please observe the following recommendations:

- in accordance with European regulations, **all children under the age of 12 or less than one and a half metres tall must travel in approved child seats suited to their weight**, on seats fitted with a seat belt or ISOFIX mountings*,
- **statistically, the safest seats in your vehicle for carrying children are the rear seats,**
- **a child weighing less than 9 kg must travel in the rearward facing position both in the front and in the rear.**

- i** **CITROËN recommends** that children should travel on the **rear seats** of your vehicle:
- **rearward facing** up to the age of 3,
 - **forward facing** over the age of 3.

* The regulations on carrying children are specific to each country. Refer to the legislation in force in your country.

Child seat at the rear

Rearward facing

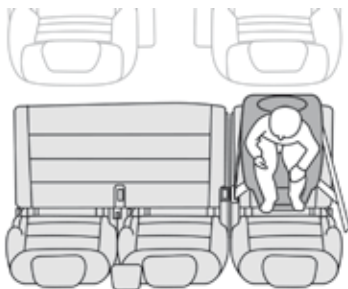

When a rearward facing child seat is installed **on a rear passenger seat**, move the vehicle's front seat forward and straighten the backrest so that the rearward facing child seat does not touch the vehicle's front seat.

Adjust the rear seat to the fully back position, with the backrest straightened.

Forward facing

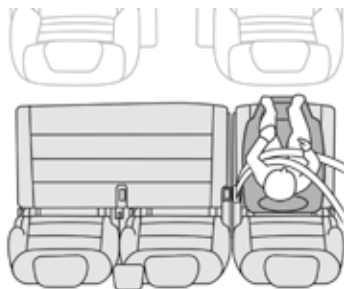

When a forward facing child seat is installed **on a rear passenger seat**, move the vehicle's front seat forward and straighten the backrest so that the legs of the child in the forward facing child seat do not touch the vehicle's front seat.

Adjust the rear seat to the fully back position, with the backrest straightened.

i Ensure that the seat belt is correctly tensioned.
For child seats with a support leg, ensure that this is in firm contact with the floor. If necessary, adjust the front seat of the vehicle.

Row 3

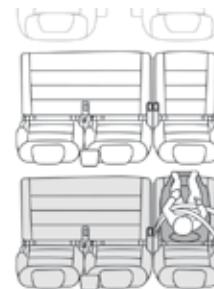

If fitted to your vehicle, when a child seat is installed on a passenger seat in the 3rd row, move the seats in the 2nd row forward and straighten the backrests so that the child seat and the child's legs do not touch the seats in the 2nd row.

Child seat at the front*

Rearward facing



When a rearward facing child seat is installed on the **front passenger seat**, adjust the seat to the fully back and highest position, with the backrest straightened.

The passenger's front airbag must be deactivated. Otherwise, **the child risks being seriously injured or killed if the airbag is deployed.**

Forward facing



When a forward facing child seat is installed on the **front passenger seat**, adjust the vehicle's seat to the fully back and highest position with the seat backrest straightened and leave the passenger's front airbag activated.

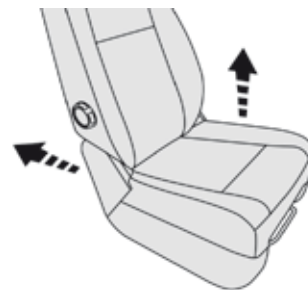

Passenger seat in the fully back and highest position.

i Ensure that the seat belt is correctly tensioned.
For child seats with a support leg, ensure that the support leg is in firm and stable contact with the floor. If necessary, adjust the passenger seat.

* Refer to the legislation in force in your country before carrying your child in this seating position.

Deactivating the passenger front airbag

- ! Never install a rearward facing child restraint system on a seat protected by an active front airbag. This could cause the death of the child or serious injury.



The warning label present on both sides of the passenger sun visor repeats this advice. In line with current legislation, the following tables contain this warning in all of the languages required.

Passenger airbag OFF

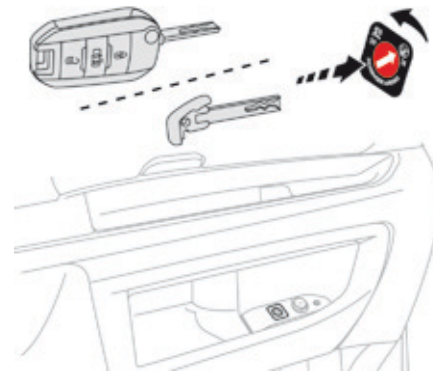

- i For more information on the **Airbags**, refer to the corresponding section.

| | |
|----|---|
| AR | لا يجب أبدا تركيب نظام لإجلال الطفل الوجه باتجاه الورا على مقعد سيارة مجهز بوسادة امان هوائية امامية مغلقة، فقد يؤدي هذا إلى التسبب بموت الطفل أو بإصابات خطيرة لديه. |
| BG | НИКОГА НЕ инсталирайте детско столче на седалка с АКТИВИРАНА предна ВЪЗДУШНА ВЪЗГЛАВНИЦА. Това може да причини СМЪРТ или СЕРИОЗНО НАРАНЯВАНЕ на детето. |
| CS | NIKDY neumistujte dětské zádržné zařízení orientované směrem dozadu na sedadlo chráněné AKTIVOVANÝM čelním AIRBAGEM. Hrozí nebezpečí SMRTI DÍTĚTE nebo VÁŽNĚHO ZRANĚNÍ. |
| DA | Brug ALDRIG en bagudvendt barnestol på et sæde, der er beskyttet af en AKTIV AIRBAG. BARNET risikerer at blive ALVORLIGT KVÆSTET eller DRÆBT. |
| DE | Montieren Sie auf einem Sitz mit AKTIVIERTEM Front-Airbag NIEMALS einen Kindersitz oder eine Babyschale entgegen der Fahrtrichtung, das Kind könnte schwere oder sogar tödliche Verletzungen erleiden. |
| EL | Μη χρησιμοποιείτε ΠΟΤΕ παιδικό κάθισμα με την πλάτη του προς το εμπρός μέρος του αυτοκινήτου, σε μια θέση που προστατεύεται από ΜΕΤΩΠΙΚΟ αερόσακο που είναι ΕΝΕΡΓΟΣ. Αυτό μπορεί να έχει σαν συνέπεια το ΘΑΝΑΤΟ ή το ΣΟΒΑΡΟ ΤΡΑΥΜΑΤΙΣΜΟ του ΠΑΙΔΙΟΥ |
| EN | NEVER use a rearward facing child restraint on a seat protected by an ACTIVE AIRBAG in front of it, DEATH or SERIOUS INJURY to the CHILD can occur |
| ES | NO INSTALAR NUNCA un sistema de retención para niños de espaldas al sentido de la marcha en un asiento protegido mediante un AIRBAG frontal ACTIVADO, ya que podría causar lesiones GRAVES o incluso la MUERTE del niño. |
| ET | Ärge MITTE KUNAGI paigaldage "seljaga sõidusuunas" lapseistetu juhi kõrvalistmele, mille ESITURVAPADI on AKTIVEERITUD. Turvapadja avanemine võib last TÕSISELT või ELUOHTLIKULT vigastada. |
| FI | ÄLÄ KOSKAAN aseta lapsen turvaistuinta selkå ajosuuntaan istuimelle, jonka edessä suojava on käyttöön aktivoitu TURVATYÖNY. Sen laukeaminen voi aiheuttaa LAPSEN KUOLEMAN tai VAKAVAN LOUKKAANTUMISEN. |
| FR | NE JAMAIS installer de système de retenue pour enfants faisant face vers l'arrière sur un siège protégé par un COUSSIN GONFLABLE frontal ACTIVÉ. Cela peut provoquer la MORT de l'ENFANT ou le BLESSER GRAVEMENT |
| HR | NIKADA ne postavljati dječju sjedalicu leđima u smjeru vožnje na sjedalo zaštićeno UKLJUČENIM prednjim ZRAČNIM JASTUKOM. To bi moglo uzrokovati SMRT ili TEŠKU OZLJEDU djeteta. |
| HU | SOHA ne használjon menetiránynak háttal beszerelt gyermekülést AKTIVÁLT (BEKAPCSOLT) FRONTLÉGSZÁKKAL védett ülésen. Ez a gyermek HALÁLÁT vagy SÜLYOS SÉRÜLÉSET okozhatja. |
| IT | NON installare MAI seggiolini per bambini posizionati in senso contrario a quello di marcia su un sedile protetto da un AIRBAG frontale ATTIVATO. Ciò potrebbe provocare la MORTE o FERITE GRAVI al bambino. |
| LT | NIEKADA neįrenkite vaiko prilaikymo priemonės su atgal atgręžtu vaiku ant sėdynės, kuri saugoma VEIKIANČIOS priekinės ORO PAGALVĖS. Išsiskleidus oro pagalvei vaikas gali būti MIRTINAI arba SUNKIAI TRAUMUOTAS. |

| | |
|----|--|
| LV | NEKAD NEuzstādiēt uz aizmuguri vērstu bērnu sēdekļīti priekšējā pasažiera sēdvietā, kurā ir AKTIVIZĒTS priekšējais DROŠĪBAS GAISA SPILVENS. Tas var izraisīt BĒRNA NĀVI vai radīt NOPIETNUS IEVAINOJUMUS. |
| MT | Qatt m'ghandek thalli tifel/tifla marbut f'siggu dahru lejn l-Airbag attiva, ghalix tista' tikkawza korriment serju jew anke mewt lit-tifel/tifla |
| NL | Plaats NOOIT een kinderzitje met de rug in de rijrichting op een zitplaats waarvan de AIRBAG is INGESCHAKELD. Bij het afgaan van de airbag kan het KIND LEVENSGEVAARLIJK GEWOND RAKEN |
| NO | Installer ALDRI et barnesete med ryggen mot kjøreretningen i et sete som er beskyttet med en frontal AKTIVERT KOLLISJONSPUTE, BARNET risikerer å bli DREPT eller HARDT SKADET. |
| PL | NIGDY nie instalować fotelika dziecięcego w pozycji "tyłem do kierunku jazdy" na siedzeniu wyposażonym w CZOŁOWĄ PODUSZKĘ POWIETRZNAJĄ w stanie AKTYWNYM. Może to doprowadzić do ŚMIERCI DZIECKA lub spowodować u niego POWAŻNE OBRAŻENIA CIAŁA. |
| PT | NUNCA instale um sistema de retenção para crianças de costas para a estrada num banco protegido por um AIRBAG frontal ACTIVADO. Esta instalação poderá provocar FERIMENTOS GRAVES ou a MORTE da CRIANÇA. |
| RO | Nu instalati NICIODATA un sistem de retinere pentru copii, dispus cu spatele in directia de mers, pe un loc din vehicul protejat cu AIRBAG frontal ACTIVAT. Aceasta ar putea provoca MOARTEA COPILULUI sau RANIREA lui GRAVA. |
| RU | ВО ВСЕХ СЛУЧАЯХ ЗАПРЕЩАЕТСЯ использовать обращенное назад детское удерживающее устройство на сиденье, защищенном ФУНКЦИОНИРУЮЩЕЙ ПОДУШКОЙ БЕЗОПАСНОСТИ, установленной перед этим сиденьем. Это может привести к ГИБЕЛИ РЕБЕНКА или НАНЕСЕНИЮ ЕМУ СЕРЬЕЗНЫХ ТЕЛЕСНЫХ ПОВРЕЖДЕНИЙ |
| SK | NIKDY neinštalujte detské zádržné zariadenie orientované smerom dozadu na sedadlo chránené AKTIVOVANÝM čelným AIRBAGOM. Mohlo by dôjsť k SMRTEĽNÉMU alebo VÁZNEMU PORANENIU DIETĀTA. |
| SL | NIKOLI ne nameščajte otroškega sedeža s hrbtom v smeri vožnje, če je VARNOSTNA BLAZINA pred sprednjim sopotnikovim sedežem AKTIVIRANA. Takšna namestitvev lahko povzroči SMRT OTROKA ali HUDE POŠKODBE. |
| SR | NIKADA ne koristite dečje sedišta koje se okreće unazad na sedištu zaštićenim AKTIVNIM VAZDUŠNIM JASTUKOM ispred njega, jer mogu nastupiti SMRT ili OZBILJNA POVREDA DETETA. |
| SV | Passagerarkrockkudden fram MÅSTE vara avaktiverad om en bakåtvänd bilbarnstol installeras på denna plats. Annars riskerar barnet att DÖDAS eller SKADAS ALLVARLIGT. |
| TR | KESİNLİKLE HAVA YASTIĞI AKTİF olan ön koltuğa yûzü arkaya dönük bir çocuk koltuğu yerleştirmeyiniz. Bu ÇOCUĞUN ÖLMESİNE veya ÇOK AĞIR YARALANMASINA sebep olabilir. |

Child seats recommended by CITROËN

CITROËN offers a range of child seats which are secured using a **three point seat belt**.

Group 0+: from birth to 13 kg



L1

"RÖMER Baby-Safe Plus"
Installed rearward facing.

Groups 2 and 3: from 15 to 36 kg**L5****"RÖMER KIDFIX XP"**

Can be fitted to the vehicle's ISOFIX mountings.

The child is restrained by the seat belt.





**L6****"BOOSTER GRACO"**

The child is restrained by the seat belt.

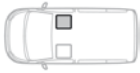

Locations for child seats secured with a seat belt

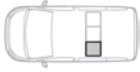
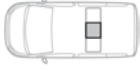
In line with European legislation, this table indicates the options for installing child seats secured using a seat belt and universally approved (a) for the weight of the child and the seat in the vehicle.

| Seat | | Weight of the child and indicative age | | | |
|---------------------|--|---|---|--|---|
| | | Under 13 kg (groups 0 (b) and 0+) Up to approx 1 year | From 9 to 18 kg (group 1) 1 to 3 years approx | From 15 to 25 kg (group 2) 3 to 6 years approx | From 22 to 36 kg (group 3) 6 to 10 years approx |
| Cab / Row 1 (c) (d) |  With individual seat, passenger seat | U | U | U | U |
| |  With bench seat, outer seat | U | U | U | U |
| |  With bench seat, centre seat | X | X | X | X |
| Row 2 (e) |  Left-hand outer seat | -* | | | |
| |  Centre seat | -* | | | |
| |  Right-hand outer seat | -* | | | |

* Submitted for type approval.

- (a) Universal child seat: child seat that can be installed in any vehicle using the seat belt.
 - (b) Group 0: from birth to 10 kg. Infant car seats and "car cots" cannot be installed on the front passenger seat.
 - (c) Consult the legislation in force in your country before installing your child on this seat.
 - (d) When a rearward facing child seat is installed on the front passenger seat, the front passenger airbag must be deactivated. Otherwise the child risks being seriously injured or killed if the airbag is deployed.
 - (e) To install a child seat on a rear seat, move the seat in front forward, then straighten the backrest to allow sufficient space for the child seat and the child's legs.
- U** Seat suitable for the installation of a child seat secured using the seat belt and universally approved, rearward facing and/or forward facing.
 - X** Seat not suitable for the installation of a child seat of the weight group indicated.

i Remove and stow the head restraint before installing a child seat with backrest on a passenger seat. Refit the head restraint once the child seat has been removed.



In line with European legislation, this table indicates the options for installing child seats secured using a seat belt and universally approved (a) for the weight of the child and the seat in the vehicle.

| Seat | | | Weight of the child and indicative age | | | | |
|-----------|--|--------------------------------------|---|---|--|---|----|
| | | | Under 13 kg (groups 0 (b) and 0+) Up to approx 1 year | From 9 to 18 kg (group 1) 1 to 3 years approx | From 15 to 25 kg (group 2) 3 to 6 years approx | From 22 to 36 kg (group 3) 6 to 10 years approx | |
| Row 1 (c) | | With individual seat, passenger seat | with passenger airbag deactivated "OFF" | U | U | U | U |
| | | | with passenger airbag activated "ON" | X | UF | UF | UF |
| | | With bench seat, centre seat | with passenger airbag deactivated "OFF" | X | X | X | X |
| | | | with passenger airbag activated "ON" | X | X | X | X |
| | | With bench seat, outer seat | with passenger airbag deactivated "OFF" | U | U | U | U |
| | | | with passenger airbag activated "ON" | X | UF | UF | UF |
| Row 2 | | Left-hand outer seat | | U | U | U | U |
| | | Centre seat | | U | U | U | U |
| | | Right-hand outer seat | | U | U | U | U |
| Row 3 | | Left-hand outer seat | | U | U | U | U |
| | | Centre seat | | U | U | U | U |
| | | Right-hand outer seat | | U | U | U | U |

- (a) Universal child seat: child seat that can be installed in any vehicle using the seat belt.
 - (b) Group 0: from birth to 10 kg. Infant car seats and "car cots" cannot be installed on the front passenger seat(s) or the seats in row 3.
 - (c) Consult the legislation in force in your country before installing your child on this seat.
- U** Seat suitable for the installation of a child seat secured using the seat belt and universally approved, rearward facing and/or forward facing.
- UF** Seat suitable for the installation of a child seat secured using the seat belt and universally approved forward facing.
- X** Seat not suitable for the installation of a child seat of the weight group indicated.

i Refit the head restraint once the child seat has been removed.

"ISOFIX" mountings

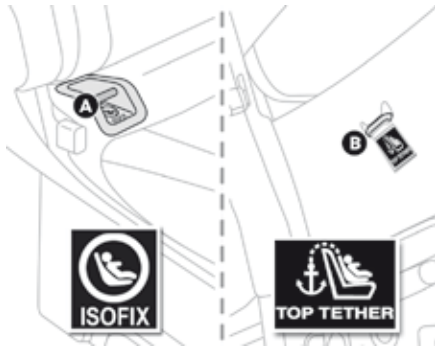

Your vehicle has been approved to the latest ISOFIX regulation.

If fitted on your vehicle, the regulation ISOFIX mountings are located by labels.

The mountings comprise three rings for each seat:

- Two front rings **A**, located between the vehicle seat backrest and cushion, indicated by an "ISOFIX" marking,
- If fitted to your vehicle, a rear ring **B**, located behind the vehicle's seat, called the Top Tether, for securing the upper strap, indicated by a "Top Tether" marking.

The Top Tether is used to secure the upper strap of child seats that have one. In the event of a front impact, this system limits the forward tipping of the child seat.

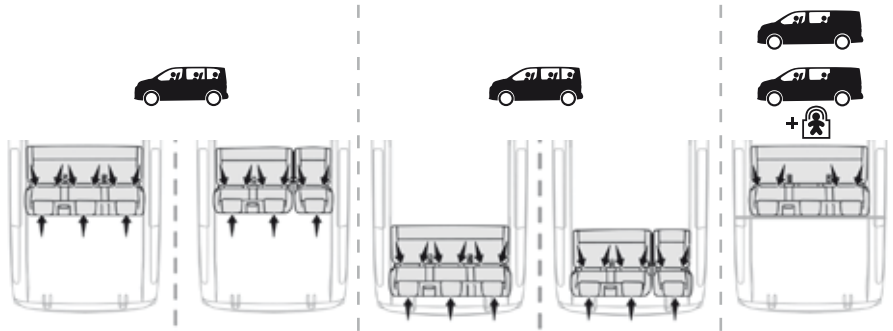

This ISOFIX mounting system provides fast, reliable and safe fitting of the child seat in your vehicle.

The ISOFIX child seats are fitted with two latches which are secured on the two front rings **A**.

Some also have an upper strap which is attached to the rear ring **B**.

To secure the child seat to the Top Tether:

- remove and stow the head restraint before installing a child seat on this seat (refit it once the child seat has been removed),
- pass the child seat upper strap over the top of the seat backrest, between the apertures for the head restraint rods,

- fix the hook on the end of the upper strap to the rear ring **B**,
- tighten the upper strap.

! The incorrect installation of a child seat in a vehicle compromises the child's protection in the event of an accident.

Observe strictly the fitting instructions provided with the child seat.

i For information on the possibilities for installing ISOFIX child seats in your vehicle, refer to the locations table.

ISOFIX child seats recommended by CITROËN

i CITROËN offers a range of ISOFIX child seats listed and type approved for your vehicle. Refer also to the child seat manufacturer's fitting instructions for information on installing and removing the seat.

"RÖMER Baby-Safe Plus" and its ISOFIX base (size category: E)

Group 0+: from birth to 13 kg

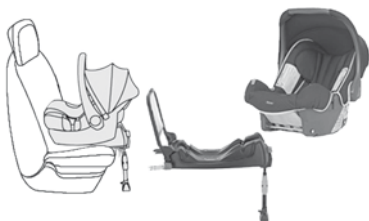

Installed rearward facing using an ISOFIX base which is attached to the rings **A**. The base has a support leg, adjustable for height, which sits on the vehicle's floor. This child seat can also be secured with a seat belt. In this case, only the shell is used and attached to the vehicle's seat by the three-point seat belt.

"RÖMER Duo Plus ISOFIX" (size category: B1)

Group 1: from 9 to 18 kg



Is installed only in the forward facing position.

Is attached to the rings **A** and the upper ring **B**, referred to as the TOP TETHER, using an upper strap.

Three seat body angles: sitting, reclining, lying down.

This child seat can also be used on seats not equipped with ISOFIX mountings. In this case, it must be secured to the vehicle's seat by the three-point seat belt. Adjust the position of the vehicle's front seat so that the child's feet are not touching the backrest.







Locations for ISOFIX child seats





In line with European legislation, this table indicates the options for installing ISOFIX child seats on seats in the vehicle fitted with ISOFIX mountings.



In the case of universal and semi-universal ISOFIX child seats, the ISOFIX size category, determined by a letter from **A** to **G**, is indicated on the child seat next to the ISOFIX logo.

| | | Weight of the child / indicative age | | | | | | | | | |
|--|--|---|---|---|---|---|--|---|----------------|---|----|
| | | Less than 10 kg (group 0) Up to approx. 6 months | | Less than 10 kg (group 0) Less than 13 kg (group 0+) Up to approx. 1 year | | | From 9 to 18 kg (group 1) From approx. 1 to 3 years | | | | |
| Type of ISOFIX child seat | | Cot | | rearward facing | | | rearward facing | | forward facing | | |
| ISOFIX size category | | F | G | C | D | E | C | D | A | B | B1 |
| Row 1 |  2-seat bench seat | Not ISOFIX | | | | | | | | | |
| |  Individual seat | Not ISOFIX | | | | | | | | | |
| Row 2 with 2-seat bench seat in row 1 |  Left-hand outer seat | -* | | | | | | | | | |
| |  Centre seat | Not ISOFIX | | | | | | | | | |
| |  Right-hand outer seat | -* | | | | | | | | | |

| | | Weight of the child / indicative age | | | | | | | | | |
|---|--|---|---|---|---|---|--|---|----------------|---|----|
| | | Less than 10 kg (group 0) Up to approx. 6 months | | Less than 10 kg (group 0) Less than 13 kg (group 0+) Up to approx. 1 year | | | From 9 to 18 kg (group 1) From 1 to 3 years approx. | | | | |
| Type of ISOFIX child seat | | Cot | | rearward facing | | | rearward facing | | forward facing | | |
| ISOFIX size category | | F | G | C | D | E | C | D | A | B | B1 |
| Row 2 with individual seats in row 1 |  Left-hand outer seat | -* | | | | | | | | | |
| |  Centre seat | Not ISOFIX | | | | | | | | | |
| |  Right-hand outer seat | -* | | | | | | | | | |

5

IUF Seat suitable for the installation of an Isofix Universal seat, Forward facing secured using the upper strap.

IL Seat suitable for the installation of an Isofix semi-universal seat either:

- rearward facing fitted with an upper strap or a support leg,
- forward facing fitted with a support leg,
- a cot fitted with an upper strap or a support leg.

X Seat not suitable for the installation of an ISOFIX child seat or cot of the weight group indicated.

* Submitted for type approval.

i For more information on the **ISOFIX mountings** and the upper strap, refer to the corresponding section.



! Refit the head restraint when the child seat is removed.



In line with European legislation, this table indicates the options for installing ISOFIX child seats on seats in the vehicle fitted with ISOFIX mountings.

In the case of universal and semi-universal ISOFIX child seats, the ISOFIX size category, determined by a letter from **A** to **G**, is indicated on the child seat next to the ISOFIX logo.

| | | | | Weight of the child / indicative age | | | | | | | | | |
|---------------------------|--|--------------------------------------|---|---|--------|---|----|--------|--|---|----------------|---|----|
| | | | | Under 10 kg (group 0) Up to approx. 6 months | | Less than 10 kg (group 0) Less than 13 kg (group 0+) Up to approx. 1 year | | | From 9 to 18 kg (group 1) From approx. 1 to 3 years | | | | |
| Type of ISOFIX child seat | | | | Cot (1) | | rearward facing | | | rearward facing | | forward facing | | |
| ISOFIX size category | | | | F | G | C | D | E | C | D | A | B | B1 |
| Row 1 (a) | | Individual seat or 2-seat bench seat | with passenger airbag deactivated "OFF" | Not ISOFIX | | | | | | | | | |
| | | | with passenger airbag activated "ON" | Not ISOFIX | | | | | | | | | |
| Row 2 | | Left-hand outer seat | | X | IL (3) | IL (2) | IL | IL (2) | IUF, IL | | | | |
| | | Centre seat (b) | | X | IL (3) | IL (2) | IL | IL (2) | IUF, IL | | | | |
| | | Right-hand outer seat | | X | IL (3) | IL (2) | IL | IL (2) | IUF, IL | | | | |

| | | Weight of the child / indicative age | | | | | | | | | |
|---------------------------|--|---|---|---|---|---|--|---|----------------|---|---------|
| | | Less than 10 kg (group 0) Up to approx. 6 months | | Less than 10 kg (group 0) Less than 13 kg (group 0+) Up to approx. 1 year | | | From 9 to 18 kg (group 1) From 1 to 3 years approx. | | | | |
| Type of ISOFIX child seat | | Cot (1) | | rearward facing | | | rearward facing | | forward facing | | |
| ISOFIX size category | | F | G | C | D | E | C | D | A | B | B1 |
| Row 3 |  Left-hand outer seat | X | | | X | | | X | | | IUF, IL |
| |  Centre seat (b) | X | | | X | | | X | | | IUF, IL |
| |  Right-hand outer seat | X | | | X | | | X | | | IUF, IL |

- (a) Consult the legislation in force in your country before installing a child seat on this seat.
- (b) The seat can be installed centrally in the vehicle; it then prevents the use of the outer seats.
- (1) The installation of a cot on this seat may prevent the use of one or both of the other seats in this row.
- (2) Installation possible only behind the driver's seat.
- (3) Installation possible only behind the driver's seat with individual passenger seat.

- IUF** Seat suitable for the installation of an Isofix Universal seat, Forward facing secured using the upper strap.
- IL** Seat suitable for the installation of an Isofix semi-universal seat either:
 - rearward facing fitted with an upper strap or a support leg,
 - forward facing fitted with a support leg,
 - a cot fitted with an upper strap or a support leg.
- X** Seat not suitable for the installation of an ISOFIX child seat or cot of the weight group indicated.

i For more information on the **ISOFIX mountings** and in particular the upper strap, refer to the corresponding section.

! Refit the head restraint when the child seat is removed.

Recommendations

! Child seats

The incorrect installation of a child seat in a vehicle compromises the child's protection in the event of an accident.

Check that there is no seat belt or seat belt buckle under the child seat as this could destabilise it.

Remember to fasten the seat belts or the child seat harnesses **keeping the slack** in relation to the child's body **to a minimum**, even for short journeys.

For the installation of a child seat using a seat belt, ensure that this is well tensioned on the child seat and that it is holding the child seat firmly against the seat of your vehicle. If your front passenger seat is adjustable, move it forward if necessary.

At the rear seats, always leave sufficient space between the front seat and:

- a rearward facing child seat,
- the feet of a child seated in a forward facing child seat.

For this, move the front seat forward and if necessary straighten its backrest.

For optimum installation of the forward facing child seat, ensure that the back of the child seat is as close as possible to the backrest of the vehicle's seat, or in contact if possible. The head restraint must be removed before installing a child seat with a backrest on the passenger seat.

Ensure that the head restraint is stowed or attached securely so that it is not thrown around the vehicle in the event of sharp braking.

Refit the head restraint as soon as the child seat is removed.

Children at the front

The legislation on carrying a child on the front passenger seat is specific to each country. Refer to the legislation in force in the country in which you are driving.

Deactivate the passenger front airbag when a rearward facing child seat is installed on the front passenger seat. Otherwise, the child would risk being seriously injured or killed if the airbag were deployed.

Installing a booster cushion

The chest part of the seat belt must be positioned on the child's shoulder without touching the neck.

Ensure that the lap part of the seat belt passes correctly over the child's thighs. CITROËN recommends the use of a booster seat which has a back, fitted with a seat belt guide at shoulder level.

As a safety precaution, do not leave:

- one or more children alone and unsupervised in a vehicle,
- a child or an animal in a vehicle which is exposed to the sun, with the windows closed,
- the keys within reach of children inside the vehicle.

To prevent accidental opening of the doors, use the child lock.

Take care not to open the rear windows by more than one third.

To protect young children from the rays of the sun, fit side blinds on the rear windows.

Manual child lock

Mechanical system to prevent opening of the sliding side door using its interior lever.

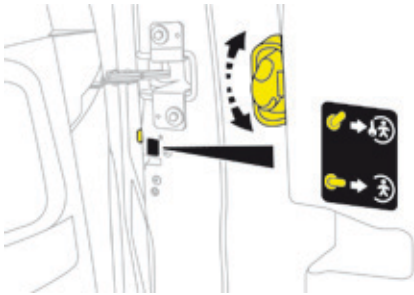

Locking



☞ Turn the control on the edge of the side door upwards.

Unlocking



☞ Turn the control on the edge of the side door downwards.

Electric child lock



Remote control system to prevent opening of the rear doors (sliding side door(s), side-hinged rear doors or tailgate) using their interior controls.



Remote control system to prevent opening of the electric sliding side door(s) by their interior controls.



Switching off



☞ With the ignition on, press this button again.

The indicator lamp in the button goes off, accompanied by a message to confirm that the child lock is off.

This indicator lamp remains off while the child lock is switched off.

Switching on



☞ With the ignition on, press this button.

The indicator lamp in the button comes on, accompanied by a message to confirm that the child lock is on.

This indicator lamp remains on until the child lock is switched off.

It is still possible to open the doors from the outside.

i In the event of a serious impact, the electric child lock is deactivated (child lock off) automatically.

! Any other status of the indicator lamp indicates a fault with the electric child lock. Have it checked by a CITROËN dealer or a qualified workshop.

! This system is independent and in no circumstances does it take the place of the central locking control. Do not drive with the sliding side door open. Check the status of the child lock each time you switch on the ignition. Always remove the key from the ignition when leaving the vehicle, even for a short time.



Child lock on rear windows

This mechanical system prevents opening of the left and/or right rear side windows.

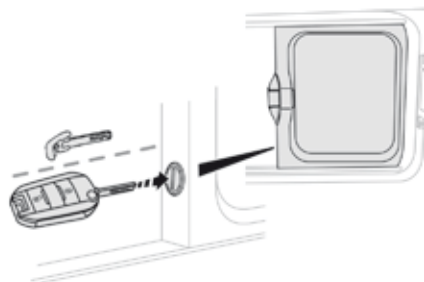

🔑 Lock/unlock the system using the remote control or the back-up key of the Keyless Entry and Starting system.

5

Driving recommendations

Observe the driving regulations and remain vigilant whatever the traffic conditions.

Pay close attention to the traffic and keep your hands on the wheel so that you are ready to react at any time to any eventuality.

On a long journey, a break every two hours is strongly recommended.

In difficult weather, drive smoothly, anticipate the need to brake and increase the distance from other vehicles.

Driving on flooded roads

We strongly advise against driving on flooded roads, as this could cause serious damage to the engine or gearbox, as well as to the electrical systems of your vehicle.

If you are obliged to drive through water:



- check that the depth of water does not exceed 15 cm, taking account of waves that might be generated by other users,
- deactivate the Stop & Start system,
- drive as slowly as possible without stalling. In all cases, do not exceed 6 mph (10 km/h),
- do not stop and do not switch off the engine.

On leaving the flooded road, as soon as circumstances allow, make several light brake applications to dry the brake discs and pads. If in doubt on the state of your vehicle, contact a CITROËN dealer or a qualified workshop.

Important!

! Never drive with the parking brake applied - Risk of overheating and damage to the braking system!
Risk of fire!

As the exhaust system of your vehicle is very hot, even several minutes after switching off the engine, do not park or run the engine over areas where inflammable substances and materials are present: grass, leaves, etc.

! Never leave a vehicle unsupervised with the engine running. If you have to leave your vehicle with the engine running, apply the parking brake and put the gearbox into neutral or position **N** or **P**, depending on the type of gearbox.

To assure the durability of your vehicle and your safety, remember that certain precautions, described hereafter, should be taken when driving your vehicle:

Manoeuvre cautiously, at low speed

The dimensions of your vehicle differ from those of a light vehicle, in width, in height, as well as in length, and some obstacles will be more difficult to notice.

Manoeuvre slowly.

Before turning, check that there are no obstacles at mid-height along the sides.

Before reversing, check that there are no obstacles, particularly at high level behind the vehicle.

Be aware of the external dimensions, if ladders are fitted.

Load the vehicle correctly

With a load carried, the vehicle must remain within the maximum authorised weight, the Gross Vehicle Weight.

To avoid upsetting the balance of the vehicle, the load should be centred and the heaviest part placed on the floor in front of the rear wheels.

It is inadvisable to place heavy loads on a roof rack.

Loading the roof rack also requires you not to exceed the maximum load on the roof rack anchorages. Observe the maximum authorised weight, available from CITROËN dealers. Loads must be securely lashed down.

Cargo that is not properly secured inside the vehicle can adversely affect the handling of the vehicle and create the risk of accident.

If your vehicle is fitted with a drop-side back, the height and width of the load must remain within the overall dimensions of the vehicle.

Drive the vehicle in a prudent and efficient way

Take corners gently.

Anticipate the need to brake as the stopping distance is increased, particularly on wet or icy roads.

Be aware of the effect of side winds on the vehicle.

Effective eco-driving saves fuel; accelerate progressively, anticipate the need to slow down and adapt your speed to suit the situation.

Indicate changes of direction well in advance so that you are seen by other road users.

Take care

The tyres must be inflated to at least the pressures indicated on the label, even over-inflated by 0.2 to 0.3 bar for long journeys. After ensuring that no obstacle might prevent closing, guide the movement of the door at the right speed until it closes.

When towing

Distribution of loads

- ☞ Distribute the load in the trailer so that the heaviest items are as close as possible to the axle and the nose weight approaches the maximum permitted without exceeding it.

Air density decreases with altitude, thus reducing engine performance. Above 1 000 metres, the maximum towed load must be reduced by 10 % for every 1 000 metres of altitude.

i For more information on **Weights**, refer to the corresponding section.

Side wind

- ☞ Take into account the increased sensitivity to side wind.

Cooling

Towing a trailer on a slope increases the temperature of the coolant. As the fan is electrically controlled, its cooling capacity is not dependent on the engine speed.

- ☞ To lower the engine speed, reduce your speed.

The maximum towed load on a long incline depends on the gradient and the ambient temperature.

In all cases, keep a check on the coolant temperature.



- ☞ If the warning lamp and the **STOP** warning lamp come on, stop the vehicle and switch off the engine as soon as possible.

i If the ambient temperature is high, it is recommended that the engine be allowed to idle for 1 to 2 minutes after the vehicle comes to a stop, to facilitate its cooling.

Braking

Towing a trailer increases the braking distance. To avoid overheating of the brakes, the use of engine braking is recommended.

Tyres

- ☞ Check the tyre pressures of the towing vehicle and of the trailer, observing the recommended pressures.

Lighting

- ☞ Check the electrical lighting and signalling on the trailer and the headlamp beam height of your vehicle.

i For more information on **Adjusting the headlamp beam height**, refer to the corresponding section.

i The rear parking sensors will be deactivated automatically to avoid the audible signal if a genuine CITROËN towbar is used.

Starting-switching off the engine, manual key, remote control

Ignition switch

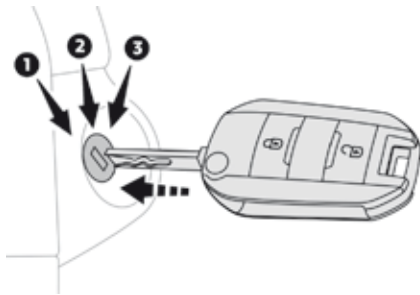

1. **Stop** position.
2. **Ignition on** position.
3. **Starting** position.

Starting using the key



The parking brake must be applied.

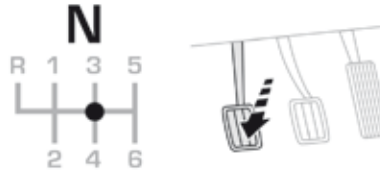

- ☞ If your vehicle has a manual gearbox, place the gear lever in neutral then fully depress the clutch pedal.

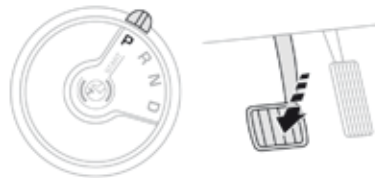

- ☞ If your vehicle has an automatic gearbox, place the selector at position **P** then press the brake pedal firmly.

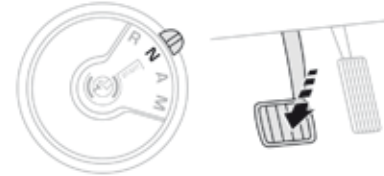

- ☞ If your vehicle has an electronic gearbox, place the selector at position **N** then press the brake pedal firmly.



- ☞ Insert the key in the ignition switch. The system recognises the starting code.
- ☞ Unlock the steering column by simultaneously turning the steering wheel and the key.

i In certain circumstances, you may have to turn the steering wheel firmly to move the road wheels (if the wheels are against a kerb, for example).

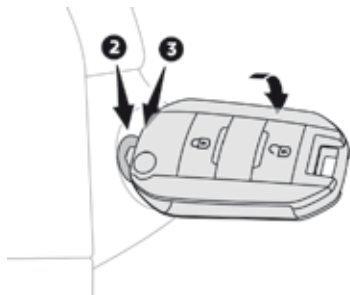

☞ Turn the key to position **2**, ignition on, to operate the engine pre-heating.



☞ Wait until this warning lamp goes off in the instrument panel then operate the starter motor by turning the key to position **3** until the engine starts, without pressing the accelerator. Once the engine starts, release the key.

i The warning lamp does not come on if the engine is already warm. Depending on the climatic conditions, it is recommended that you proceed as follows:

- In temperate conditions, do not run the engine with the vehicle stationary to warm it up, but rather move off straight away and drive at moderate engine speeds.
- In wintry conditions, the pre-heater warning lamp will stay on for a longer period after switching on the ignition; wait until it goes off before starting.
- In **very severe wintry conditions** (temperature below -23°C), to ensure the correct operation and durability of the mechanical components of your vehicle (engine and gearbox), **leave the engine running for 4 minutes** before moving off.

Never leave the engine running in an enclosed area without adequate ventilation: internal combustion engines emit toxic exhaust gases, such as carbon monoxide. Danger of intoxication and death.

! If the engine does not start straight away, switch off the ignition. Wait a few moments before trying again. If the engine does not start after a few attempts, do not keep trying: you risk damaging the starter motor and the engine. Call on a CITROËN dealer or a qualified workshop.

- !** To avoid any risk of jamming of the pedals:
- only use mats which are suited to the fixings already present in the vehicle; these fixings must be used,
 - never fit one mat on top of another.
- The use of mats not approved by CITROËN may interfere with access to the pedals and hinder the operation of the cruise control / speed limiter. The mats approved by CITROËN have two fixings located below the seat.

Switching off using the key

- ☞ Immobilise the vehicle.

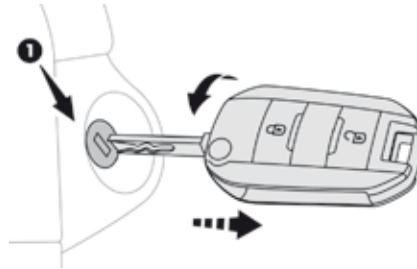

- ☞ Turn the key fully towards you to position **1 (Stop)**.
- ☞ Remove the key from the ignition switch.
- ☞ To lock the steering column, turn the steering wheel until it locks.

- i** To facilitate unlocking of the steering wheel, it is recommended that you place the wheels in the straight ahead position before switching off the engine.

- (!)** ☞ Check that the parking brake is correctly applied, particularly when parking on a slope.

- !** Never switch off the ignition until the vehicle has been brought to a complete stop.

- i** When leaving the vehicle, remove the key and lock the doors. As a safety measure (children on board), never leave the vehicle without your remote control with you, even for a short period.

- !** Switching off the engine leads to a loss of braking assistance.

- i** Avoid attaching heavy objects to the key, which would weigh down on its blade in the ignition switch and could cause a malfunction.

i Key left in the "Ignition on" position

If the key has been left in the ignition switch at position **2 (Ignition on)**, the ignition will be switched off automatically after one hour. To switch the ignition back on, turn the key to position **1 (Stop)**, then back to position **2 (Ignition on)**.

Starting-switching off the engine, "Keyless Entry and starting"

Starting



- ☞ Place the remote control inside the vehicle, in the recognition zone.



- ☞ If your vehicle has a manual gearbox, fully depress and hold down the clutch pedal until the engine starts.

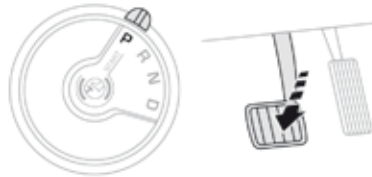

- ☞ If your vehicle has an automatic gearbox, place the selector at position **P** then press the brake pedal firmly.



- ☞ If your vehicle has an electronic gearbox, place the selector at position **N** then press the brake pedal firmly.

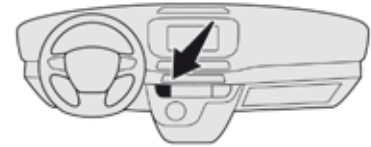

- ☞ Then, press the "**START/STOP**" button.

The steering column unlocks and the engine starts more or less immediately.



For **Diesel vehicles**, in sub-zero temperatures the engine will not start until the pre-heater warning lamp has gone off. If this warning lamp comes on after pressing the "START/STOP" button, press down on the brake or clutch pedal until the warning lamp goes off, without pressing the "START/STOP" button again, until the engine starts and runs.

i The presence in the recognition zone of the remote control of the "Keyless Entry and Starting" system is essential. Never leave the vehicle with the engine running and with the remote control on your person. If the remote control leaves the recognition zone, a message is displayed. Move the remote control into the zone to be able to start the engine.

i If one of the starting conditions is not met, a message appears in the instrument panel screen. In some circumstances, it is necessary to turn the steering wheel slightly while pressing the "START/STOP" button to assist unlocking of the steering; a message warns you when this is needed.

Switching off

☞ Immobilise the vehicle.



☞ With the remote control in the recognition zone, press the "START/STOP" button.

The engine stops and the steering column is locked.

i If the vehicle is not immobilised, the engine will not stop.

! To avoid any risk of jamming of the pedals:

- only use mats which are suited to the fixings already present in the vehicle; these fixings must be used,
- never fit one mat on top of another.

The use of mats not approved by CITROËN may interfere with access to the pedals and hinder the operation of the cruise control / speed limiter. The mats approved by CITROËN have two fixings located below the seat.

Ignition on (without starting)



With the Keyless Entry and Starting remote control inside the vehicle, pressing the "START/STOP" button, **with no action on the pedals**, allows the ignition to be switched on. This also allows the accessories to be used (for example: audio system, lighting...).



☞ Press the "START/STOP" button, the instrument panel comes on but the engine does not start.



☞ Press the button again to switch off the ignition and allow the vehicle to be locked.

i With the ignition on, the system automatically goes into energy economy mode to maintain an adequate state of charge in the battery.

Back-up starting

Should your vehicle not detect the electronic key in the recognition zone, because the remote control battery is flat, a back-up reader is provided to the left, behind the steering wheel to allow starting.

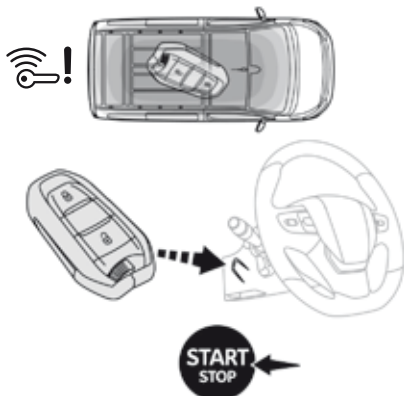

- ☞ Place and hold the remote control against the reader, then:
- ☞ If your vehicle has a manual gearbox, place the gear lever in neutral then fully depress the clutch pedal.
- ☞ If your vehicle has an automatic gearbox, place the selector at position **P** then press the brake pedal firmly.
- ☞ If your vehicle has an electronic gearbox, place the selector at position **N** then press the brake pedal firmly.
- ☞ Press the "START/STOP" button. The engine starts.

Forced switch-off

In the event of an emergency only and with the vehicle stationary, you can switch off the engine.



To do this, press and hold the "START/STOP" button for about 3 seconds. In this case the steering column locks as soon as the vehicle stops.

Remote control not recognised

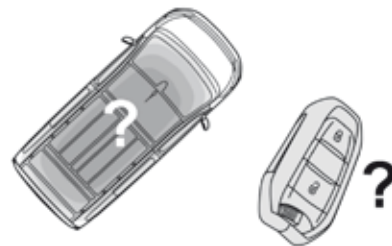

If the remote control is no longer in the recognition zone when you close a door or when you (later) request switching off the engine, a message appears in the instrument panel.



- ☞ If you want to force switching off the engine, press and hold the "START/STOP" button for about 3 seconds, then contact a CITROËN dealer or a qualified workshop.

Anti-theft protection

Electronic engine immobiliser

The keys contain an electronic chip which has a secret code. When the ignition is switched on, this code must be recognised in order for starting to be possible.

This electronic engine immobiliser locks the engine management system a few minutes after the ignition is switched off and prevents starting of the engine by anyone who does not have the key.

In the event of a malfunction, you are informed by a message in the instrument panel screen.

In this case, your vehicle does not start; contact a CITROËN dealer if required.

! For reasons of safety and theft protection, do not leave your electronic key in the vehicle, even when you are close to it.

It is recommended that you keep it on your person.

Parking brake

Application

- ☞ With your foot on the brake pedal, pull the parking brake lever up to immobilise your vehicle.

Release on level ground

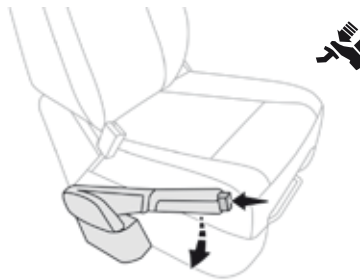

- ☞ With your foot on the brake pedal, pull the parking brake lever up gently, press the release button then lower the lever fully.



When the vehicle is being driven, this warning lamp coming on, accompanied by an audible signal and a message, indicates that the parking brake is still on or has not been fully released.



When parking on a slope, or on a steep slope with a laden vehicle, turn the wheels against the kerb then apply the parking brake.

If your vehicle has a manual gearbox, engage a gear then switch off the ignition.

If your vehicle has an automatic gearbox, place the gear selector at position **P** then switch off the ignition.

If your vehicle has an electronic gearbox, place the gear selector at position **A** then switch off the ignition.



Pressing the brake pedal facilitates the application and release of the manual parking brake.

Hill start assist

System which keeps your vehicle immobilised temporarily (approximately 2 seconds) when starting on a gradient, the time it takes to move your foot from the brake pedal to the accelerator pedal.

It only operates when:

- the vehicle is completely stationary, with your foot on the brake pedal,
- the driver's door is closed.

This hill start assist system cannot be deactivated.

! Do not leave the vehicle while it is being held in the hill start assist phase.

If you need to get out of the vehicle with the engine running, apply the parking brake manually then ensure that the parking brake indicator lamp is on.

! If your vehicle has an automatic gearbox and you have to move off on a steep slope (rising or falling) with a loaded vehicle, **press the brake pedal**, select position **D**, release the parking brake then release the brake pedal.

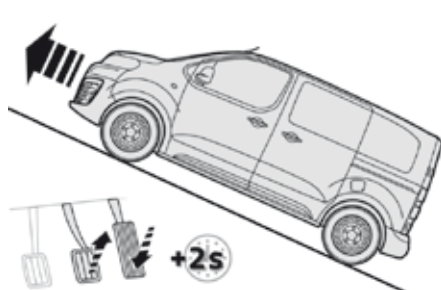

On an ascending slope, with the vehicle stationary, the vehicle is held for a momentarily when you release the brake pedal.

- ☞ If your vehicle has a manual gearbox, place the lever in the first gear position or in neutral.
- ☞ If your vehicle has an automatic gearbox, place the selector at position **D** or select manual operation **M**.
- ☞ If your vehicle has an electronic gearbox, place the selector at position **A** or **M**.

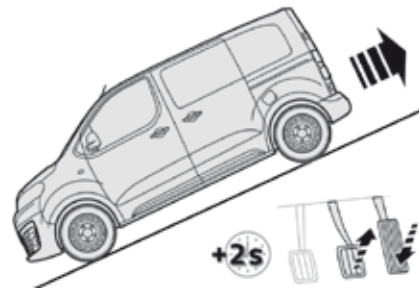

On a descending slope, with the vehicle stationary and reverse gear engaged, the vehicle is held momentarily when you release the brake pedal.

Operating fault



If a fault in the system occurs, this warning lamp comes on accompanied by a message. Contact a CITROËN dealer or a qualified workshop as soon as possible to have the system checked.

5-speed manual gearbox

Engaging reverse gear

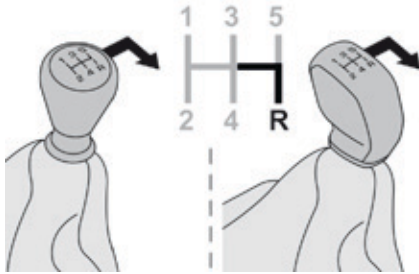

- ☞ With the clutch pedal fully down, place the gear lever in neutral.
- ☞ Push the gear lever to the right then backwards.

! Only engage reverse gear when the vehicle is stationary with the engine at idle.

- i** As a safety precaution and to facilitate starting of the engine:
- always select neutral,
 - press the clutch pedal.

6-speed manual gearbox

Engaging 5th or 6th gear

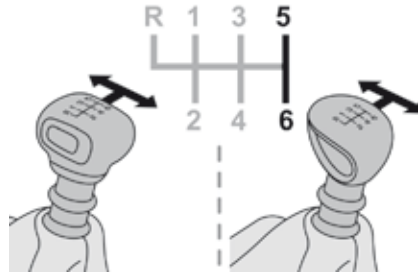

- ☞ Move the lever fully to the right to engage 5th or 6th gear.

! Failure to follow this advice may cause permanent damage to the gearbox (engagement of 3rd or 4th gear by mistake).

Engaging reverse gear

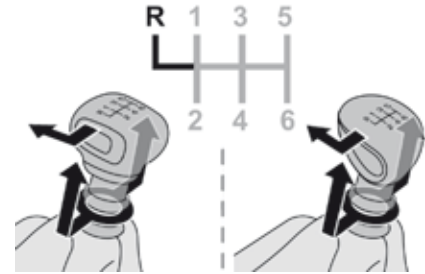

- ☞ Raise the ring under the knob and move the gear lever to the left then forwards.

! Only engage reverse gear when the vehicle is stationary with the engine at idle.

- i** As a safety precaution and to facilitate starting of the engine:
- always select neutral,
 - press the clutch pedal.

Gear efficiency indicator

System which reduces fuel consumption by recommending the most suitable gear.

Depending on the driving situation and your vehicle's equipment, the system may advise you to skip one or more gears.

You can follow this instruction without going through the intermediate gears.



On certain BlueHDi Diesel versions with manual gearbox, the system may suggest changing into neutral (N is displayed in the instrument panel) so that the engine can go into standby (STOP mode with Stop & Start), in certain driving conditions.



The gear engagement recommendations must not be considered compulsory. This is because the configuration of the road, traffic density and safety remain important factors in the choice of the best gear.

The gear efficiency indicator system does not replace the need for vigilance on the part of the driver.



This function cannot be deactivated.

Example:

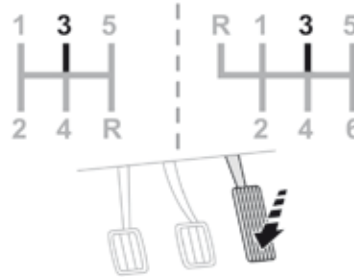

- You are in third gear.
- You press the accelerator pedal.

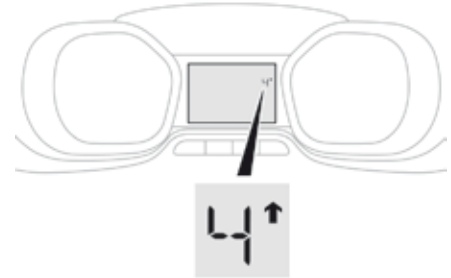

- The system may suggest that you engage a higher gear.

The information appears in the instrument panel in the form of an arrow.

On vehicles with manual gearbox, the arrow may be accompanied by the recommended gear.



The system adapts its gear change recommendation according to the driving conditions (gradient, load, ...) and the demands of the driver (power, acceleration, braking, ...).

The system never suggests:

- engaging first gear,
- engaging reverse gear.

Automatic gearbox

Six speed automatic gearbox which offers a choice between the comfort of automatic operation or manual gear changing.

Two driving modes are offered:

- **automatic** operation for electronic management of the gears by the gearbox,
- **manual** operation for sequential changing of the gears by the driver.

When operating automatically, it remains possible to change gear manually using the steering mounted control paddles, when overtaking, for example.

Gear selector

! To turn the gear selector in complete safety, it is recommended that you keep your foot on the brake.

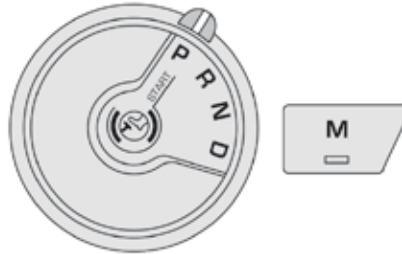

- P.** Park.
 - ☞ With your foot on the brake, turn the selector to this position for parking or starting.
- R.** Reverse.
 - ☞ Turn the selector to this position.
- N.** Neutral.
 - ☞ Turn the selector to this position for starting.
- D.** Automatic operation.
 - ☞ Turn the selector to this position.
- M.** Manual operation with sequential gear changing
 - ☞ Selector in position **D**, press this button then use the steering mounted control paddles to change gear.

i Position **N** can be used in traffic jams or in a car wash tunnel.

Steering mounted controls



- ☞ Pull the right hand "+" control paddle towards you to change up.
- ☞ Pull the left hand "-" control paddle towards you to change down.

i The steering mounted control paddles cannot be used to select neutral or to select or come out of reverse.

Displays in the instrument panel

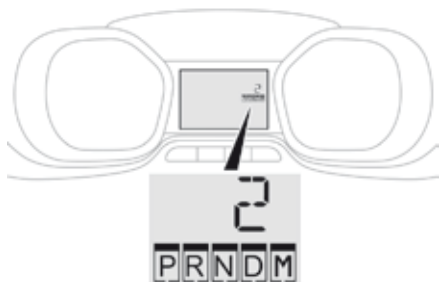

When you move the gear selector or press the **M** button, the corresponding symbol appears in the instrument panel.

- P.** Park
- R.** Reverse
- N.** Neutral
- D.** Drive (automatic operation)
- M.** Manual operation
- 1 to 6.** Gear engaged
- Invalid value



- ☞ If the message "**Foot on brake**" is displayed in the instrument panel, press the brake pedal firmly.

Moving off

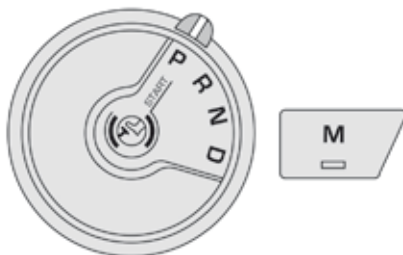

- ☞ With your foot on the brake, select position **P**.

- ☞ Start the engine.

If the conditions are not met, there is an audible signal, accompanied by a message in the instrument panel screen.

- ☞ Release the parking brake.
- ☞ Select position **R**, **N** or **D**.



If you have to move off on a steep slope with a loaded vehicle, **press the brake pedal**, select position **D**, then release the parking brake.

- ☞ Gradually release the brake pedal. The vehicle moves off.



If **P** is displayed in the instrument panel but the selector is in another position, place the selector in position **P** to allow the engine to be started.

If position **N** is engaged inadvertently while driving, allow the engine to return to idle then engage position **D** to accelerate.



When the engine is running at idle, with the brakes released, if position **R**, **D** or **M** is selected, the vehicle moves even without the accelerator being pressed.

Never leave children in the vehicle without supervision.

As a safety measure, never leave the vehicle without taking your key or remote control with you, even for a short time.

When carrying out maintenance with the engine running, apply the parking brake and select position **P**.

Automatic operation

D  Select position **D** for **automatic** changing of the six gears.

The gearbox then operates in auto-adaptive mode, without any intervention on the part of the driver. It continuously selects the most suitable gear according to the style of driving, the profile of the road and the load in the vehicle.



For maximum acceleration, without touching the selector press the accelerator pedal down fully (kick-down). The gearbox changes down automatically or maintains the gear selected until the maximum engine speed is reached. On braking, the gearbox changes down automatically to provide effective engine braking.

If you release the accelerator sharply, the gearbox will not change to a higher gear, for safety reasons.

! Never select position **N** while the vehicle is moving.
Never select position **P** or **R** unless the vehicle is completely stationary.

Temporary manual control of gear changes



You can temporarily take control of gear changes using the "+" and "-" steering mounted control paddles. The gear change instruction is acted on if the engine speed permits. This function allows you to anticipate certain situations, such as overtaking another vehicle or approaching a bend in the road. Following a few moments with no action on the control paddles, the gearbox returns to automatic operation.

Creep function (moving without using the accelerator)

This function provides great flexibility in manoeuvring the vehicle at low speed (when parking, in traffic jams, ...).

With the engine at idle, parking brake released and position **D**, **M** or **R** selected, the **vehicle moves** as soon as you take your foot off the brake pedal (even without pressing the accelerator).

! As a safety measure (children on board), never leave the vehicle with the engine running and the doors closed.

Manual operation

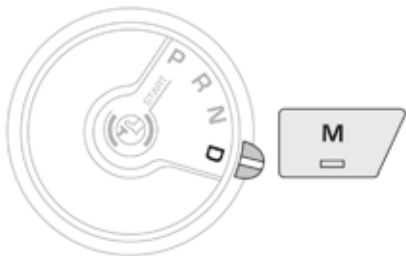

☞ With the selector in position **D**, press button **M** for **sequential** changing of the six gears.

The indicator associated with the button comes on.



☞ Operate the "+" or "-" steering mounted control paddle.



M appears and the gears engaged appear in succession in the instrument panel.



☞ It is possible to return to automatic operation at any time by pressing button **M** again.

The indicator associated with the button goes off.



In manual mode it is not necessary to release the accelerator pedal when changing gear.



It is only possible to change from one gear to another if the vehicle speed and engine speed permit.



If the engine speed is too low or too high, the gear selected flashes for a few seconds, then the actual gear engaged is displayed.

When the vehicle is stationary or moving very slowly, the gearbox selects gear **M1** automatically.



To save the brakes when descending a steep incline, use engine braking to reduce your speed (take your foot off the accelerator pedal or change down). Keeping the brake pedal pressed continuously for long periods can overheat the brakes, with the risk of damaging the braking system or making it inoperative. Only use the brakes when necessary, to slow or stop the vehicle.



Depending on the configuration of the road (for example: mountain pass), it may be preferable to use manual operation. This is because automatic operation may not be best suited, not allowing the use of engine braking.

Invalid value during manual operation



This symbol is displayed if a gear is not engaged correctly (gear selector between two positions).

☞ Place the selector "correctly" at a position.

Stopping the vehicle

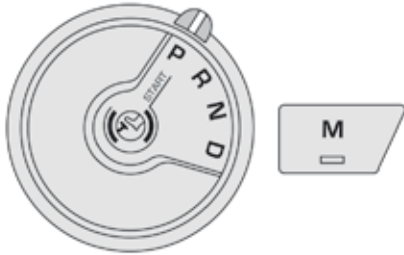

Before switching off the engine, select position **P** then apply the parking brake to immobilise the vehicle.

- i** A stiff point may be noticed when moving to position **P**.
If the selector is not in position **P**, when the driver's door is opened or approximately 45 seconds after the ignition is switched off, there is an audible signal and a message appears.
- ☞ Return the selector to position **P**; the audible signal stops and the message disappears.

! On a steep slope with a loaded vehicle, **press the brake pedal**, select position **P**, apply the parking brake then release the brake pedal.

! In all circumstances, ensure that the selector is in position **P** before leaving your vehicle.

Operating fault

SERVICE When the ignition is on, a message appears in the instrument panel screen to indicate a gearbox fault.

In this case, the gearbox switches to back-up mode and is locked in 3rd gear. You may feel a substantial knock when changing from **P** to **R** and from **N** to **R**. This will not cause any damage to the gearbox.
Do not exceed 60 mph (100 km/h), local speed restrictions permitting.
Have it checked by a CITROËN dealer or a qualified workshop.

! You risk damaging the gearbox:

- if you press the accelerator and brake pedals at the same time (braking or acceleration must be done only with the right foot),
- if you force the selector from position **P** to another position when the battery is flat.



To reduce fuel consumption when stationary for long periods with the engine running (traffic jam...), position the selector at **N** and apply the parking brake.

Electronic gearbox

Electronically controlled gearbox which offers a choice between the comfort of fully automatic operation and manual gear changing.

There are two driving modes:

- **automatic** operation for automatic control of the gears by the gearbox, without any action on the part of the driver,
- **manual** operation for sequential gear changing by the driver using the steering mounted paddles.

With automatic operation, you can temporarily take over control of gear changing at any time.

Gear selector



- R.** Reverse
 - ☞ Turn the selector to this position.
- N.** Neutral.
 - ☞ With your foot on the brake, turn the selector to this position for starting.
- A.** Automatic operation.
 - ☞ Turn the selector to this position.
- M.** Manual operation with sequential gear changing.
 - ☞ Turn the selector to this position, then use the steering mounted control paddles to change gear.

! To turn the gear selector in complete safety, it is recommended that you keep your foot on the brake.

Steering mounted control paddles



- ☞ Pull the right hand "+" control paddle towards you to change up.
- ☞ Pull the left hand "-" control paddle towards you to change down.

i The steering mounted paddles cannot be used to select neutral or to select or come out of reverse gear.

Display in the instrument panel



When you move the gear selector, the symbol corresponding to its position is displayed in the instrument panel.

- R. Reverse
- N. Neutral
- AUTO or A.** Automatic operation.
- M. Manual operation
- 1 to 6.** Gear engaged
- Invalid value

Moving off

- ☞ Select position **N**.
- ☞ Press the brake pedal down fully.
- ☞ Start the engine.



N appears in the instrument panel screen.

i If the engine does not start:

If **N** flashes in the instrument panel, accompanied by an audible signal and a message, move the selector to position **A** then to position **N**.



If the **Foot on brake** warning lamp comes on the instrument panel, accompanied by an audible signal and a message "Foot on brake", press the brake pedal firmly.

- ☞ Select automatic operation (position **A**), manual operation (position **M**), or reverse (position **R**).
- ☞ Release the parking brake.
- ☞ Progressively take your foot off the brake pedal; the vehicle then moves off.

Automatic operation

- ☞ After starting the engine, select position **A** for automatic gear changes



AUTO and the gear engaged are displayed in the instrument panel.

The gearbox operates in auto-active mode, without any action on the part of the driver. It continuously selects the most suitable gear for:

- the style of driving,
- the profile of the road.



For optimum acceleration, for example when overtaking another vehicle, press the accelerator pedal firmly past the point of resistance.

Temporary manual control of gear changes



You can **temporarily** take control of gear changes using the "+" and "-" steering mounted control paddles. The gear change instruction is acted on if the engine speed permits. This function allows you to anticipate certain situations, such as overtaking another vehicle or approaching a bend in the road. Following a few moments with no action on the control paddles, the gearbox returns to automatic operation.

Manual operation

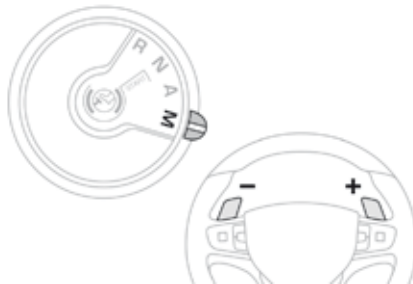

- ☞ After starting the engine, select position **M** for **sequential** gear changing
- ☞ Operate the "+" or "-" steering mounted control paddle.



AUTO disappears and the gears engaged are displayed successively in the instrument panel.

i It is not necessary to release the accelerator during gear changes. When braking or slowing down, the gearbox changes down automatically to allow the vehicle to accelerate in the correct gear.

! On sharp acceleration, the gearbox will not change up unless the driver acts on the steering mounted paddles. Never select neutral **N** when driving. Only engage reverse **R** with the vehicle stationary and your foot on the brake.

i The change from one gear to another takes place only if the conditions of vehicles speed and engine speed permit; if not, the automatic operation laws are applied temporarily.

Reverse

To engage reverse gear, the vehicle must be immobilised with your foot on the brake pedal.



☞ Select position **R**.

Engagement of reverse gear is accompanied by an audible signal.

i At low speed, if reverse gear is requested, the **N** indicator flashes and the gearbox goes into neutral automatically. To engage reverse, move the selector to position **N**, then position **R**.

Stopping the vehicle



Before switching off the engine, you can:

- move to position **N** to engage neutral,
- or
- leave the gear engaged; in this case, it will not be possible to move the vehicle.

In both cases, you must apply the parking brake to immobilise the vehicle.

! When immobilising the vehicle, with the engine running, you must move the selector to neutral **N**. Before doing anything under the bonnet ensure that the selector is in neutral **N** and that the parking brake is applied.

Operating fault

With the ignition on, the flashing of **A** or **AUTO**, accompanied by an audible signal and a message, indicates a malfunction of the gearbox.

Have it checked by a CITROËN dealer or a qualified workshop.

! Always press the brake pedal when starting the engine.
In all parking situations, you must apply the parking brake to immobilise the vehicle.

Stop & Start

The Stop & Start system puts the engine temporarily into standby - STOP mode - during stops in the traffic (red lights, traffic jams, or other...). The engine restarts automatically - START mode - as soon as you want to move off. The restart takes place instantly, quickly and silently.

Perfect for urban use, the Stop & Start system reduces fuel consumption and exhaust emissions as well as the noise level when stationary.

Going into engine STOP mode

If your vehicle has a **manual gearbox**, its speed must be below 12 mph (20 km/h) or stationary (depending on engine); the "ECO" indicator lamp comes on in the instrument panel and the engine goes into standby automatically when you place the gear lever in neutral and you release the clutch pedal.

If your vehicle has an **automatic gearbox** and the vehicle is stationary, the "ECO" indicator lamp comes on and the engine goes into standby automatically when you press the brake pedal or place the gear selector in position **N**.

If your vehicle has an **electronic gearbox** and the vehicle's speed is below 5 mph (8 km/h), the "ECO" indicator lamp comes on and the engine goes into standby automatically when you press the brake pedal or place the gear selector in position **N**.

Stop & Start time counter

(minutes / seconds or hours / minutes)



If your vehicle is fitted with Stop & Start, a time counter calculates the time spent in STOP mode during a journey. It resets to zero every time the ignition is switched on.

i For your comfort, during parking manoeuvres, STOP mode is not available for a few seconds after coming out of reverse gear. Stop & Start does not affect the functionality of the vehicle, such as for example, braking, power steering... A slight delay between the vehicle stopping and the engine cutting out may be noticed.

! Never refuel with the engine in STOP mode; you must switch off the ignition with the button.

Special cases: STOP mode not available

STOP mode is not invoked in certain temporary conditions (examples: battery charge, engine temperature, braking assistance, ambient temperature) to assure correct operation of the system and mainly when:

- the vehicle is on a steep slope (rising or falling),
- the driver's door is open,
- a sliding side door is open,
- the driver's seat belt is not fastened,
- the vehicle has not exceeded 6 mph (10 km/h) since the last engine start by the driver,
- the electric parking brake is applied or being applied,
- the engine is needed to maintain a comfortable temperature in the passenger compartment,
- demisting is active.

ECO In this case, the "ECO" warning lamp flashes for a few seconds then goes off.

This operation is perfectly normal.

ECO Going into engine START mode

If your vehicle has a **manual gearbox**, the "ECO" indicator lamp goes off in the instrument panel and the engine restarts automatically when you **fully** depress the clutch pedal.

If your vehicle has an **automatic gearbox**, the "ECO" lamp goes off in the instrument panel and the engine restarts automatically when:

- you release the brake pedal with the gear selector in position **D** or **M**,
- you are in position **N** with the brake pedal released and you move the gear selector to position **D** or **M**,
- you engage reverse.

If your vehicle has an **electronic gearbox**, the "ECO" lamp goes off in the instrument panel and the engine restarts automatically when:

- you release the brake pedal with the gear selector in position **A** or **M**,
- you are in position **N** with the brake pedal released and you move the gear selector to position **A** or **M**,
- you engage reverse.

Special cases: START invoked automatically

START mode is invoked automatically in certain temporary conditions (examples: battery charge, engine temperature, braking assistance, air conditioning setting) to assure correct operation of the system and mainly when:

- you open the driver's door,
- you open a sliding side door,
- you unfasten the driver's seat belt,
- the speed of the vehicle exceeds 15 mph (25 km/h) or 2 mph (3 km/h) (depending on the engine) with a manual gearbox,
- the speed of the vehicle exceeds 2 mph (3 km/h) with an automatic gearbox,

ECO In this case the "ECO" warning lamp flashes for a few seconds, then goes off.

This operation is perfectly normal.

Deactivation / Activation With / Without audio system



To deactivate the system:



- ☞ Press the button, its indicator lamp comes on, the system is deactivated.

To activate the system:



- ☞ Press this button, the indicator lamp goes off, the system is activated

With the touch screen



In the **Driving** menu, activate/deactivate "**Stop & Start system**".

- ! If the system has been deactivated in STOP mode, the engine restarts immediately.

- i The system is reactivated automatically every time the engine is started by the driver.

- ! **Opening the bonnet**
Before doing anything under the bonnet, deactivate the Stop & Start system to avoid the risk of injury related to an automatic change to START mode.

! Driving on flooded roads

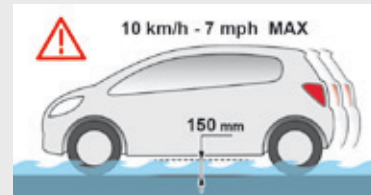

Before driving through a flooded road, it is strongly recommended that you deactivate the Stop & Start system. For more information on **Driving advice**, particularly on flooded roads, refer to the corresponding section.

Operating fault

Depending on your vehicle's equipment:



In the event of a fault with the system, this warning lamp flashes in the instrument panel.



The warning lamp in this button flashes and a message appears, accompanied by an audible signal.

Have it checked by a CITROËN dealer or a qualified workshop.

In the event of a fault in STOP mode, the vehicle may stall.

All of the instrument panel warning lamps come on.

Depending on version, an alert message may also be displayed, asking you to place the gear lever in position **N** and put your foot on the brake pedal.

With the vehicle stationary, you must switch off the ignition and then start the engine again.



The Stop & Start system requires a 12 V battery with a special specification and technology.

All work on this type of battery must be done by a CITROËN or a qualified workshop.

For more information on the **12 V battery**, refer to the corresponding section.

Head-up display

System which projects various information onto a smoked blade in the driver's field of vision so that they do not have to take their eyes off the road.

Displays during operation

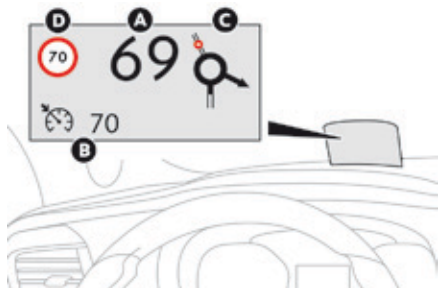

Once the system has been activated, the following information is grouped together in the head-up display:

- A. The speed of your vehicle.
- B. Cruise control/speed limiter information.
- C. If your vehicle is so equipped, inter-vehicle distance information, automatic emergency braking alerts and navigation instructions.
- D. If your vehicle is so equipped, speed limit information.

Buttons

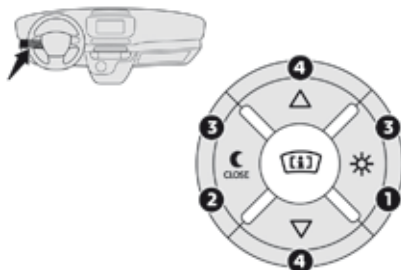

1. On.
2. Off (long press).
3. Brightness adjustment.
4. Display height adjustment.

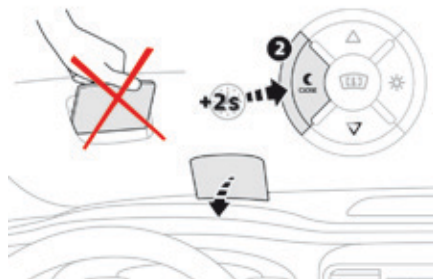

i For more information on **Navigation**, refer to the **Audio and telematics** section.

Activation / Deactivation



☞ With the engine running, press button **1** to activate the system and deploy the blade.

+3s ☞ Press and hold button **2** to deactivate the system and retract the blade.

The activated/deactivated state is saved and retained on restarting the engine.

Height adjustment



- ☞ With the engine running, adjust the display to the desired height using buttons 4:
- up to move the display up,
 - down to move the display down.

Brightness adjustment



- ☞ With the engine running, adjust the brightness of the information displayed using buttons 3:
- the "sun" to increase the brightness,
 - the "moon" to decrease the brightness.

! We recommend that adjustments are made using these buttons only when the vehicle is stationary. When stationary or while driving, no objects should be placed around the blade (or in its recess) so as to not impede deployment of the blade and its correct operation.

i In certain extreme weather conditions (rain and/or snow, bright sunshine, ...) the head-up display may not be legible or may suffer temporary interference. Some sunglasses may hamper reading of the information.

To clean the blade, use a clean, soft cloth (such as a spectacles cloth or microfibre cloth). Do not use a dry or abrasive cloth or detergent or solvent products as these could scratch the blade or damage the non-reflective coating.

i This system operates when the engine is running and the settings are stored when the ignition is switched off.

Memorising speeds

This function allows speeds to be saved, which can then be offered to set the two systems: the speed limiter (to limit the speed of the vehicle) or the cruise control (for a vehicle cruising speed).

You can memorise up to six speed settings for each of the two systems.

Programming

The speed settings can be adjusted in the touch screen.



- ☞ In the **Driving** menu, select "**Adjust speed settings**".

! As a safety measure, the driver should carry out these operations when stationary.

- ☞ Select the system for which you want to memorise new speed settings:



- speed limiter

or



- cruise control.



- ☞ Press the button corresponding to the speed setting you want to modify.
- ☞ Enter the new value using the numerical keypad and confirm.
- ☞ Confirm to save the modification and quit the menu.

i MEM Memorised speeds are recalled by pressing this button.

Speed limit recognition

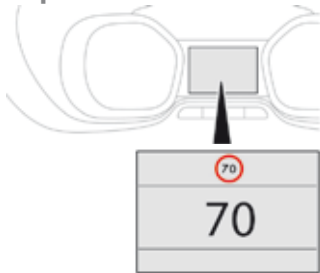

This system allows the speed limit detected by the camera to be displayed in the instrument panel.

Specific speed limits, such as those for heavy goods vehicles, are not displayed.

The display of the speed limit in the instrument panel is updated as you pass a speed limit sign intended for cars (light vehicles).

! The units for the speed limits (mph or km/h) depend on the country you are driving in.

It should be taken into account so that you observe the speed limit.

For the system to operate correctly when you change country, the units for speed in the instrument panel must be those for the country you are driving in.

Principles

N Depending on equipment, the system takes account of speed limit information from the navigation system mapping.

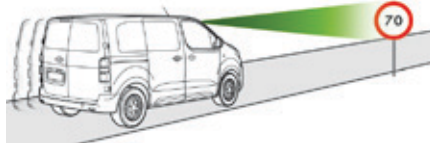

Depending on equipment, using a camera at the top of the windscreen, this system detects and reads speed limit and end of speed limit signs.

Depending on equipment, the system takes account of the camera and information from the navigation system mapping.

! The automatic reading of road signs is a driving assistance system and does not always display speed limits correctly. The speed limit signs present on the road always take priority over the display by the system.

The system cannot in any circumstances replace the need for vigilance on the part of the driver. The driver must observe the driving regulations and must adapt the speed of the vehicle to suit the weather and traffic.

It is possible for the system to not display the speed limit if it does not detect a speed limit sign within a preset period.

The system is designed to detect signs that conform to the Vienna Convention on road signs.

i To maintain correct operation of the system: regularly clean the area in front of the camera.

i For the speed limit information given by the navigation system to be correct, your mapping software must be regularly updated.

Display in the instrument panel

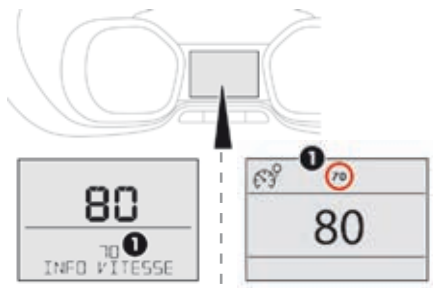

Head-up display

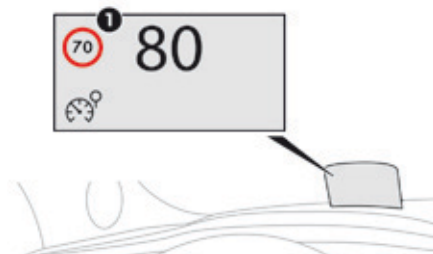

1. Indication of the speed limit.

Display of the speed

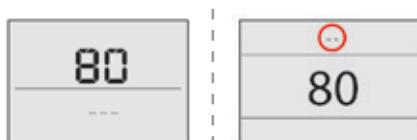

The system is active but is not detecting speed limit information.

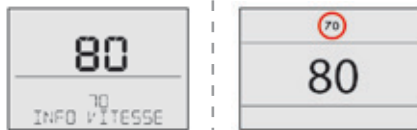

On detection of speed limit information, the system displays the figure.



The driver can, if desired, adjust the speed of the vehicle according to the information given by the system.

Activation / Deactivation

The system is activated or deactivated via the vehicle configuration menu.

With the audio system



In the "Personalisation-configuration" menu, activate/deactivate "Speed recommendation".

With the touch screen



In the vehicle settings menu, activate/deactivate "Displaying of the recommended speed".

Operating limits

The legislation on speed limits is specific to each country.

The system does not take account of reduced speed limits in the following cases:

- poor weather (rain, snow),
- atmospheric pollution,
- trailer, caravan,
- driving with snow chains fitted,
- puncture repair using the temporary repair kit,
- young drivers.

Operation of the system may be disrupted or it may not work at all in the following situations:

- poor visibility (inadequate street lighting, falling snow, rain, fog),
- windscreen area ahead of the camera dirty, misty, frosty, covered with snow, damaged or masked by a sticker,
- fault with the camera,
- obsolete or incorrect mapping,
- hidden road signs (other vehicles, vegetation, snow),
- speed limit signs that do not conform to the standard, are damaged or distorted.

- i** Clean the area of the windscreen in front of the camera regularly.

Memorising the speed setting

This memorisation is in addition to the display of **Speed limit recognition**.



The driver can choose to adapt the speed setting to the speed limit suggested, by pressing the memorisation button at the speed limiter controls, with the standard cruise control or the dynamic cruise control.

This speed setting then replaces the previous speed setting for the speed limiter and/or dynamic cruise control.

- i** For more information on the **Speed limiter, Cruise control** or **Dynamic cruise control**, refer to the corresponding sections.

Steering mounted controls

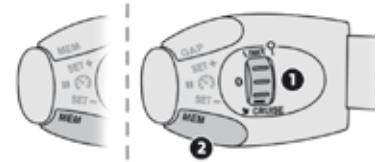

1. Select speed limiter/cruise control mode.
2. Memorise a speed setting.

Display in the instrument panel

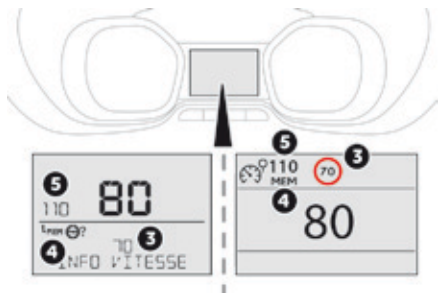

Head-up display

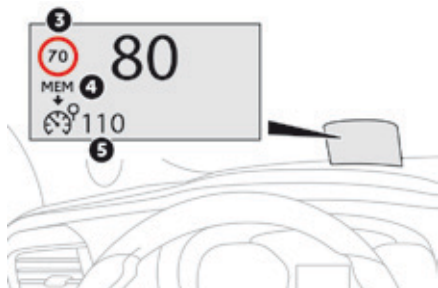

3. Speed limiter indication.
4. Memorise the speed.
5. Current speed setting.

Memorising



- ☞ When the speed limiter/cruise control is switched on, the corresponding information is displayed.



- On detection of a speed limit sign, the system displays the speed limit value and offers to make it the speed setting.
- "MEM" flashes in the screen for a few seconds.



- MEM** ☞ Make an **initial** press on this button to display the suggested limit speed.



- MEM** ☞ Press this button **again** to confirm the new speed setting.

Speed limiter ("LIMIT")

System which prevents the vehicle from exceeding the speed programmed by the driver.

Once the programmed speed limit is reached, additional pressure on the accelerator pedal has no effect.



The programmed speed remains in the memory when the ignition is switched off.



The speed limiter cannot, in any circumstances, replace the need to observe speed limits, nor can it replace the need for vigilance on the part of the driver.



GAP

For more information on this button and the **Dynamic cruise control**, refer to the corresponding section.



MEM

For more information on **Memorising speeds**, refer to the corresponding section.



For more information on **Speed limit recognition** and memorising them in particular, refer to the corresponding section.

Steering mounted controls

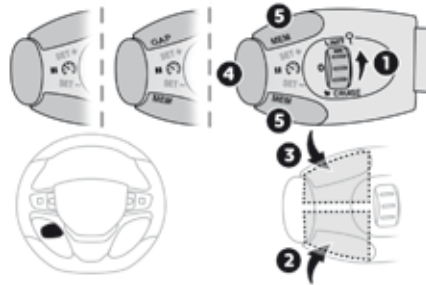

1. Select speed limiter mode.
2. Lower the programmed speed.
3. Raise the programmed speed.
4. Speed limiter on / pause.
5. If fitted to your vehicle, display the list of memorised speeds or memorise the speed suggested by the speed limit recognition system.

Display in the instrument panel

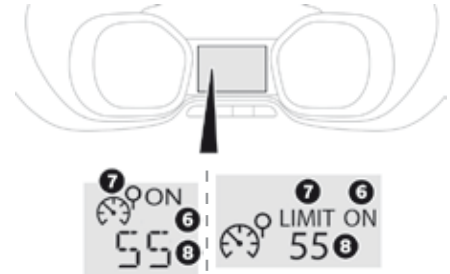

Head-up display

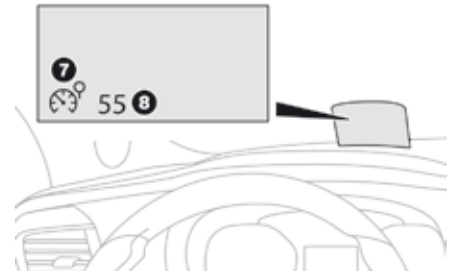

6. Speed limiter on/pause indication.
7. Speed limiter mode selection indication.
8. Speed value setting.

Switching on / Pause

Switching on the speed limiter requires a programmed speed of at least 20 mph (30 km/h). The speed limiter is **paused** by operation of the control.



- ☞ Turn thumbwheel **1** to the "**LIMIT**" position: the speed limiter mode is selected but is not switched on (Pause).
- ☞ Switch the speed limiter back on by pressing button **4**, if the speed displayed is suitable (by default, the last speed programmed).
- ☞ You can temporarily stop the speed limiter by pressing button **4** again: the display confirms that it has been stopped (Pause).



The programmed speed can be exceeded temporarily by pressing the accelerator firmly beyond the point of resistance.



To return to the programmed speed, simply release the accelerator pedal until the vehicle returns to the programmed speed limit.

Adjusting the speed limiter setting

You do not have to switch the speed limiter on in order to set the speed.

Once the function is selected, you can modify the speed setting by:

- using buttons **2** and **3**, raising or lowering the speed displayed:
 - ☞ by successive short presses, to modify by + or - 1 mph (km/h),
 - ☞ by a maintained press, to modify in steps of + or - 5 mph (km/h).

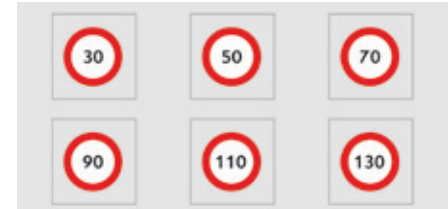

- pressing button **5**, if your vehicle has speed memorisation:
 - ☞ the six speeds memorised are displayed in the touch screen,
 - ☞ press the button corresponding to the speed limit chosen.

The value is then displayed in the instrument panel.

The selection screen closes after a few moments.

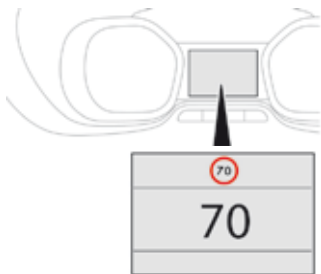

- by pressing button **5**, if your vehicle has speed limit recognition:
 - ☞ the speed to be memorised is displayed in the instrument panel,
 - ☞ press button **5 again** to save the speed.
- The value is then displayed in the instrument panel.

i

MEM

For more information on **Speed limit recognition**, refer to the corresponding section.

Temporarily exceeding the programmed speed

- ☞ Press **firmly** on the accelerator pedal, going beyond the **point of resistance**, to exceed the programmed speed limit.

The speed limiter is deactivated temporarily and the displayed programmed speed flashes. An audible signal accompanies the flashing of the programmed speed when exceeding the speed is not due to an action by the driver (steep hill...).

As soon as the vehicle's speed returns to the programmed value, the limiter operates again: the display of the programmed speed becomes steady again.

Switching off



- ☞ Turn thumbwheel **1** to the **"0"** position. The display of speed limiter information disappears.

Operating fault



Flashing of the dashes indicates a fault with the speed limiter.

Have it checked by a CITROËN dealer or a qualified workshop.



On sharp acceleration, as when descending a steep hill, the speed limiter will not be able to prevent the vehicle from exceeding the programmed speed.

The limiter is temporarily deactivated and the displayed programmed speed flashes.

An audible signal accompanies the flashing of the programmed speed when exceeding the speed is not due to an action by the driver.



The use of mats not approved by CITROËN may interfere with the operation of the speed limiter.

To avoid any risk of jamming of the pedals:

- ensure that the mat is secured correctly,
- do not fit one mat on top of another.

Cruise control ("CRUISE")

System which automatically maintains the speed of the vehicle at the value programmed by the driver, without any action on the accelerator pedal.

i Switching off the ignition cancels any programmed speed value.

! The cruise control system cannot, in any circumstances, replace the need to observe speed limits, nor can it replace the need for vigilance on the part of the driver. You are advised to keep your feet near the pedals at all times.

i For more information on **Memorising speeds**, refer to the corresponding section.

MEM

i For more information on **Speed limit recognition**, refer to the corresponding section.

MEM

Steering mounted controls

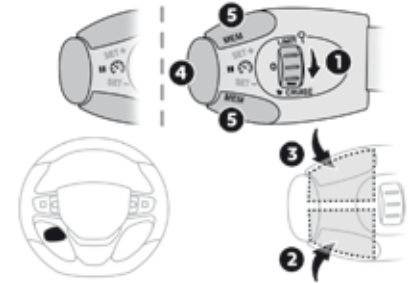

1. Select cruise control mode.
2. Programme a speed setting/Lower the speed setting.
3. Programme a speed setting/Raise the speed setting.
4. Pause-resume cruise control.
5. If fitted to your vehicle, display the list of memorised speeds or memorise the speed offered by the speed limit recognition system.

Display in the instrument panel

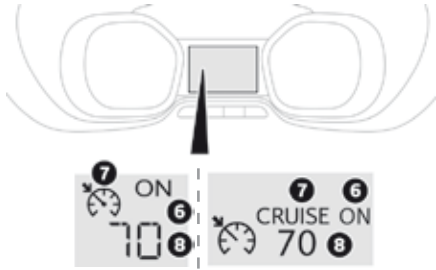

Switching on

The cruise control is **switched on** manually: it requires a minimum vehicle speed of 25 mph (40 km/h).

If your vehicle has a manual gearbox, third or fourth gear, or higher, must be engaged.

If your vehicle has an automatic or electronic gearbox, second gear or higher must be engaged.

i It is possible to exceed the programmed speed temporarily by pressing the accelerator pedal.

To return to the programmed speed, simply release the accelerator pedal until the programmed cruise speed is reached again.

Head-up display

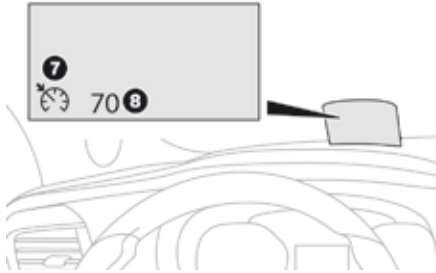

- 6. Cruise control pause/resume indication.
- 7. Cruise control mode selection indication.
- 8. Speed value setting.



- ☞ Turn thumbwheel **1** to the "**CRUISE**" position: the cruise control mode is selected but is not switched on (Pause).
- ☞ Press on button **2** or **3**: your vehicle's current speed becomes the cruise speed. The cruise control is activated (ON).

Modification of the initial speed setting

If the cruise control is switched on, you can then modify the initial speed in one of the following ways:

- using buttons **2** or **3**:
 - ☞ by successive short presses, to modify the speed by + or - 1 mph (km/h),
 - ☞ by a long press, to modify the speed in steps of + or - 5 mph (km/h),



- by pressing on button **5**, if your vehicle is equipped with speed memorisation:
 - ☞ the six memorised speeds are displayed in the touch screen,
 - ☞ select a value: it is displayed in the instrument panel.

The selection screen closes after a few moments.

The modification is then accepted.

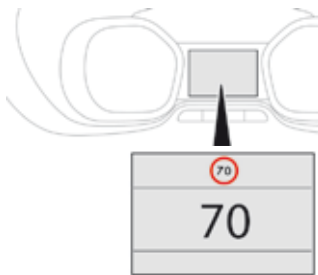

- by pressing on button **5**, if your vehicle is equipped with speed memorisation:
 - ☞ the speed to be memorised is displayed in the instrument panel,
 - ☞ press on button **5 again** to save the speed.

The value is then displayed in the instrument panel.

i For more information on **Speed limit recognition**, refer to the corresponding section.

Pause

The cruise control is paused manually or by pressing the brake or clutch pedal or on triggering of the ESC system for safety reasons.



Once switched on, you can pause the cruise control at any time by pressing button 4: the screen confirms the pause.

Exceeding the programmed speed

If the programmed speed is exceeded, the displayed speed flashes.
Once the vehicle returns to the programmed speed, the display becomes steady again.

Switching off



- ☞ Turn thumbwheel 1 to the "0" position.
The display of information related to the cruise control disappears.

Operating fault



Flashing of the dashes indicates a fault with the cruise control.
Have it checked by a CITROËN dealer or a qualified workshop.

- ! When the cruise control is switched on, be careful if you maintain the pressure on one of the programmed speed changing buttons: this may result in a very rapid change in the speed of your vehicle.
Do not use the cruise control on slippery roads or in heavy traffic.

- ! On a steep descent, the cruise control will not be able to prevent the vehicle from exceeding the programmed speed. On steep climbs or when towing, the programmed speed may not be achieved or maintained.

- ! The use of mats not approved by CITROËN may interfere with the operation of the cruise control. To avoid any risk of jamming of the pedals:
 - ensure that the mat is secured correctly,
 - never fit one mat on top of another.

Dynamic cruise control ("CRUISE")

This systems allows the vehicle's speed to be maintained at a value set by the driver. In addition it allows (when circumstances permit) an inter-vehicle distance that you have selected to be maintained between your vehicle and the vehicle in front.

Activation / Deactivation



The cruise control selection thumbwheel must be at the "CRUISE" position, otherwise the selection is not taken into account. Activation or deactivation of the system is via the vehicle configuration menu.

With the touch screen



In the **Driving** menu, activate/deactivate "**Dynamic cruise control**".

i The state of the system is memorised on switching off the ignition.

Steering mounted controls

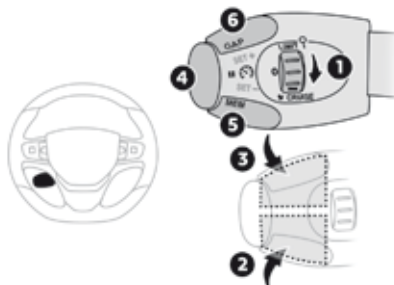

1. Select cruise control mode.
2. Programme a speed setting/Reduce the speed setting.
3. Programme a speed setting/Increase the speed setting.
4. Pause / Resume cruise control.
5. If fitted to your vehicle, display the list of memorised speeds or memorise the speed suggested by the speed limit recognition system.
6. Select the inter-vehicle distance ("**Close**", "**Normal**", "**Distant**").

i By default, the inter-vehicle distance is set at "**Normal**". Otherwise, the last setting made will be used when switching on the system.

Display in the instrument panel

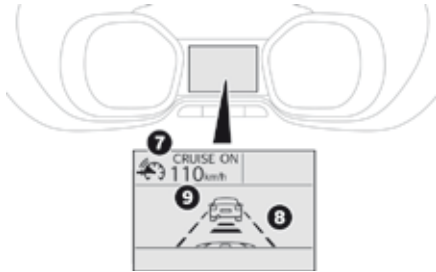

Head-up display

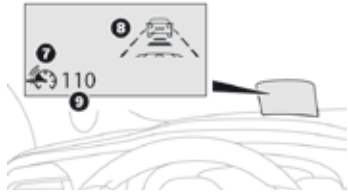

7. Indication of cruise control pause/resume.
8. Indication of selection of cruise control mode, or vehicle speed adjustment phase.
9. Cruise speed setting.

i For more information on the **Head-up display**, refer to the corresponding section.

Switching on

The dynamic cruise control is **switched on** manually, it requires that the speed of the vehicle be between 25 mph (40 km/h) and 90 mph (150 km/h).

If the cruise speed setting is above 90 mph (150 km/h), the dynamic cruise control switches to normal cruise control mode (without automatic regulation of the safe inter-vehicle distance).

If your vehicle has a manual gearbox, third or fourth gear, or higher, must be engaged.

If your vehicle has an automatic or electronic gearbox, second gear or higher must be engaged.

i For more information on the **Cruise control**, refer to the corresponding section.

The dynamic cruise control must be selected in the "**Driving**" menu.



- ☞ Turn the thumbwheel **1** to the "**CRUISE**" position: cruise control mode is selected, but not started (Pause).
- ☞ Press one of the buttons **2** or **3**: the current speed of your vehicle becomes the cruise speed setting.

The cruise control is activated (ON).

6

Modification of the cruise control speed only

If the cruise control is on, you can then modify the initial speed:

- using button **2** or **3**:
 - ☞ by successive short presses, to modify by steps of + or - 1 mph (km/h),
 - ☞ by a maintained press, to modify in steps of + or - 5 mph (km/h).



- by pressing button **5**, if your vehicle has speed memorisation:
 - ☞ the six memorised settings are displayed in the touch screen,
 - ☞ choose a speed setting: it is displayed in the instrument panel.

The selection screen closes after a few moments.

The modification is then taken into account.

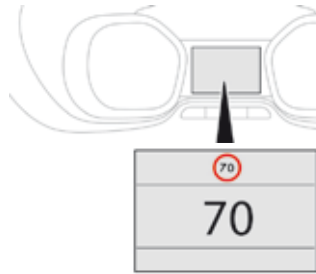

- by pressing button **5**, if your vehicle has speed limit recognition:
 - ☞ the speed to memorise is displayed in the instrument panel,
 - ☞ press button **5 again** to save the speed. The setting is then displayed in the instrument panel.

i For more information on **Speed limit recognition** and in particular **MEM** its memorisation, refer to the corresponding section.

i As a precaution, it is recommended that you select a cruise speed setting close to the current speed of your vehicle.

Inter-vehicle distance



Using a radar with a range of about 100 metres, located at the front of the vehicle, this system detects a vehicle running in front of your vehicle.

It automatically adapts the speed of your vehicle to that of the vehicle in front.

If the vehicle in front is running more slowly, the system progressively reduces the speed of your vehicle using just engine braking (as if the driver had pressed the "-" button).

If your vehicle is too close to, or approaching too quickly the vehicle in front, the dynamic cruise control is automatically deactivated.

The driver is then alerted by an audible signal, accompanied by a message.

If the vehicle in front accelerates or changes lane, the dynamic cruise control progressively accelerates your vehicle to return to the programmed speed.

If the driver operates a direction indicator to overtake a slower vehicle, the dynamic cruise control allows your vehicle to temporarily approach the vehicle in front to assist the overtaking manoeuvre, though never exceeding the programmed speed.

Modification of the inter-vehicle distance



- Press button 6 to select a new inter-vehicle distance setting from the three levels ("Close", "Normal", "Distant").

This value remains in memory, regardless of the state of the system.

i In the event of the presence of a vehicle detected by the inter-vehicle distance radar, if the speed selected is too far above the speed of that vehicle, the system is not activated and the alert message "Activation not possible, conditions unsuitable" is displayed until driving conditions are safe to allow activation of the system.

i The inter-vehicle distance setting is memorised when the ignition is switched off.

Exceeding the programmed speed



It is possible to exceed the programmed speed temporarily by depressing the accelerator pedal.



Simply release the accelerator pedal to return to the programmed speed.

If the programmed setting is unintentionally exceeded, descending a steep hill for example, the speed setting in the instrument panel flashes as a warning.

Pause

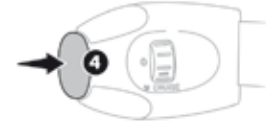





The dynamic cruise control can be **paused** manually with the control, or automatically:

- by pressing the brake or clutch pedal,
- in the event of operation of the ESC, for safety reasons,
- when an inter-vehicle distance threshold is reached (calculated according to the relative speeds of your vehicle and the vehicle in front and the inter-vehicle distance setting selected),
- when the distance between your vehicle and the one in front becomes too small,
- when the speed of the vehicle in front is too low,
- when the speed of your vehicle becomes too low.

Driving situations and associated alerts

The following table describes the alerts and the messages displayed for the different driving situations. The display of these alerts is not sequential.

| Symbol | Associated message | Comments |
|---|-------------------------|--|
|  | | No vehicle detected: the system operates as a standard cruise control. |
|  | | Detection of a vehicle, at the limit of the range of the radar: the system operates as a standard cruise control. |
|  | "SPEED ADJUSTED" | Detection of a vehicle that is too close or running at a speed lower than your vehicle's cruise speed setting. The system uses engine braking to slow your vehicle (within a limit of 20 mph (30 km/h)) and then hold it at the speed of the vehicle in front so as to observe the programmed inter-vehicle time. When automatically slowing down behind a vehicle, your true speed may be higher than the "adjusted speed" displayed. |
|  | "SPEED ADJUSTED" | When the adjusted speed reaches the limit of regulation (speed setting less than 20 mph (30 km/h)), the adjusted speed flashes together with the speed setting to signal that automatic deactivation of the system is imminent. |
|  | "Cruise control paused" | If the system exceeds the limit of speed adjustment possible by the system and in the absence of any reaction by the driver (operation of the direction indicator, change of lane, reduction of the speed of the vehicle), the system is automatically paused. The display of the deactivation message is accompanied by an audible signal. |

! When the dynamic cruise control is automatically paused, it can only be reactivated when safe conditions are restored. The message "Activation not possible, conditions unsuitable" is displayed while reactivation is not possible.

When the conditions allow, it is recommended that the function be reactivated by pressing button **2** (SET+) or **3** (SET-), which will make the current speed of your vehicle the new cruise speed setting, rather than by pressing button **4** (on/pause) which reactivates the cruise control using the old cruise speed setting, which may be very different from the current speed of your vehicle.

Limits of operation

The speed regulation range is limited to a maximum difference of 20 mph (30 km/h) between the speed setting and the speed of the vehicle in front.

Above this, the system goes into pause if the safe distance becomes too small.

The dynamic cruise control uses only engine braking to slow the vehicle. Consequently the vehicle loses speed slowly, as when releasing the accelerator pedal.

The system is paused automatically:

- if the vehicle in front slows down too much or too suddenly, and the driver does not brake,
- if a vehicle comes between your vehicle and the vehicle in front,
- if the system does not slow the vehicle enough to continue to maintain a safe distance, for example when descending a steep hill.

As the radar's field of detection is quite narrow, it is possible that the system may not detect:



- vehicles of reduced width, such as motorcycles, for example,



- vehicles not running in the middle of the lane,



- vehicles entering a corner,
- vehicles changing lane at the last moment.

i The cruise control does not take account of:

- stationary vehicles,
- vehicles driving in the opposite direction.

Operating fault

In the event of a fault with the dynamic cruise control, you are alerted by an audible signal and display of the message message "Driving aid functions fault".

Have the system checked by a CITROËN dealer or a qualified workshop.

! The dynamic cruise control cannot in any circumstances replace the observation of speed limits, nor the need for the vigilance on the part of the driver.

i The dynamic cruise control operates by day and at night, in fog or moderate rainfall.

! The system does not act on the braking system, but works only with engine braking.
The regulation range is limited: there will no longer be any adjustment of speed if the difference between the programmed speed setting and the speed of the vehicle in front becomes too high.

! If the difference between the programmed speed setting and the speed of the vehicle in front is too great, the speed cannot be adjusted: the cruise control is automatically deactivated.

! When the cruise control is working, take care if making a maintained press on one of the cruise control programmed speed modification buttons: this can lead to a very quick change in the speed of your vehicle.
Do not use the dynamic cruise control on slippery surfaces or in heavy traffic.

! When descending a steep hill, the cruise control may not be able to prevent the vehicle from exceeding the programmed speed.
When ascending a steep hill or when towing, it might not be possible to achieve or maintain the programmed speed.

! The use of mats not approved by CITROËN may interfere with the operation of the dynamic cruise control. To avoid any risk of jamming the pedals:

- ensure that mats are secured correctly,
- never fit one mat on top of another.

It is recommended that you always keep your feet close to the pedals.

Collision Risk Alert and Active Safety Brake



The **Collision Risk Alert** system allows the driver to be warned that their vehicle is at risk of collision with the vehicle in front or a pedestrian in their traffic lane.

The **Active Safety Brake** system intervenes following the alert if the driver does not react quickly enough and does not operate the vehicle's brakes.

If the driver fails to act, it contributes towards avoiding a collision or limiting its severity by reducing the speed of your vehicle.



These systems use a radar located in the front bumper and a camera at the top of the windscreen.



These systems are designed to improve road safety. It is the driver's responsibility to continuously monitor the state of the traffic, observing the driving regulations. These systems do not replace the need for vigilance on the part of the driver.

Conditions for operation

The **Collision Risk Alert** system only operates:

- with a registered vehicle pointing in the same direction as the traffic, moving or stationary,
- with pedestrians.
- from 4 mph (7 km/h) (and is deactivated at 3 mph (5 km/h)).

The **Active Safety Brake** system operates:

- between 3 and 87 mph (5 and 140 km/h), in the case of a moving vehicle,
- at a speed below 50 mph (80 km/h), in the case of a stationary vehicle,
- at a speed below 36 mph (60 km/h), in the case of a pedestrian,
- if the passenger seat belts are fastened,
- if the vehicle is not accelerating sharply,
- if the vehicle is not in a tight corner.

The **Active Safety Brake** system does not operate:

- if the front bumper is damaged,
- if the system has been triggered in the last 10 seconds,
- if the electronic stability control system has a fault.

! Following an impact, the system is automatically disabled; contact a CITROËN dealer or a qualified workshop to have the system checked.

Limits of operation

It is recommended that the system be deactivated in the vehicle configuration menu in the following cases:

- if the windscreen has impact damage close to the detection camera,
- when towing a trailer or caravan,
- when a load on the roof rack extends beyond the windscreen (for example: long objects),
- when the vehicle is being towed, with the engine running,
- when a "space-saver" type spare wheel is fitted (if your vehicle has one),
- when on a rolling road for a service in a workshop,
- when in an automatic car wash,
- if the brake lamps are not working.

Collision Risk Alert

Depending on the degree of risk of collision detected by the system and the alert threshold chosen, different levels of alert can be triggered and displayed in the instrument panel or the head-up display.

i This information also appears in the head-up display. For more information on the **Head-up display**, refer to the corresponding section.



Level 1: visual alert only, warning you that the vehicle ahead is very close. A message on your vigilance is displayed as you close on the vehicle ahead.



This level of alert is based on the inter-vehicle time between your vehicle and the vehicle ahead.



Level 2: visual and audible alert, warning you that a collision is imminent.



A message indicating that you should brake is displayed.

This level of alert is based on the time before collision. It takes account of the vehicle dynamics, the speed of your vehicle and the one in front, the environmental conditions, the operation of the vehicle (cornering, pedals pressed, etc.) to trigger the alert at the best moment.

i Where the speed of your vehicle is too high approaching another vehicle, the first level of alert may not be displayed: the level 2 alert may be displayed directly.

Furthermore, the level 1 alert is never displayed with the "**Close**" threshold. Poor weather conditions (very heavy rain, accumulation of snow in front of the radar and the camera) may hinder the operation of the system, with the display of an operating fault message. The system remains out of service until the message disappears.

Programming the alert thresholds

The thresholds for triggering an alert determine how you wish to be warned of the presence of a vehicle moving or stationary ahead of you, or a pedestrian in your traffic lane.

You can select one of three thresholds:

- "**Distant**", to be warned early (cautious driving).
- "**Normal**".
- "**Close**", to be warned later.

With the audio system



In the "**Personalisation-configuration**" menu, activate/deactivate "**Auto. emergency braking**".

Then modify the alert threshold.

With the touch screen



In the vehicle settings menu, activate/deactivate "**Collision risk alert and automatic braking**".

Then modify the alert threshold.

Press on "**Confirm**" to save the change.

Active Safety Brake



This system, also called automatic emergency braking, aims to reduce the speed of impact or avoid a frontal collision by your vehicle (between 3 and 87 mph (5 and 140 km/h)) where the driver fails to react.

Using a radar and a camera, this system acts on the vehicle's braking system.



If the radar and the camera have confirmed the presence of a vehicle or a pedestrian, this warning lamp flashes when the system is operating.



Important: if operation of the automatic emergency braking is triggered, you should take back control of your vehicle and **brake** with the pedal to add to or finish the automatic braking.

The driver can take back control of the vehicle at any time by sharply turning the steering wheel and/or pressing the accelerator pedal.

i The point at which braking is triggered may be adjusted according to the reaction from the driver, such as movement of the steering wheel or pressing the accelerator pedal.

i Operation of the system may be felt by slight vibration in the brake pedal. If the vehicle comes to a complete stop, the automatic braking is maintained for 1 to 2 seconds. If your vehicle has a manual gearbox, in the event of the automatic emergency braking bringing the vehicle to a complete stop, the engine may stall. If your vehicle has an automatic gearbox, in the event of the automatic emergency braking bringing the vehicle to a complete stop, the vehicle will move off again; press the brake pedal.

i If automatic emergency braking is not activated, you are alerted by the fixed display of this warning lamp accompanied by a message.

i Intelligent emergency braking assistance

If the driver does not brake sufficiently to avoid an accident, this system will complete the braking.

This emergency braking system will not act if you press the brake pedal.

Deactivation / Activation of the alert and the braking

By default, the function is automatically activated at every engine start. The deactivation or activation of the function is done in the vehicle configuration menu.

With the audio system



In the "**Personalisation-configuration**" menu, activate/deactivate "**Auto. emergency braking**".

With the touch screen



In the vehicle settings menu, activate/deactivate "**Collision risk alert and automatic braking**".

Operating fault



In the event of a fault, you are alerted by the illumination of this warning lamp, accompanied by an audible signal and a message.

Contact a CITROËN dealer or a qualified workshop.

i There may be interference in the operation of the camera or it not work at all in the following situations:

- poor visibility (inadequate street lighting, falling snow or rain, fog, ...),
- dazzle (headlamps of an approaching vehicle on the other side of the road, low sun, reflection on a wet road, leaving a tunnel, alternating between light and shade, ...),
- the area in front of the windscreen: dirty, misty, frosty, snow-covered, damaged or covered by a sticker.

The operation of the radar, located in the front bumper, may be disturbed in certain weather conditions: with accumulations of snow, ice, mud, ...

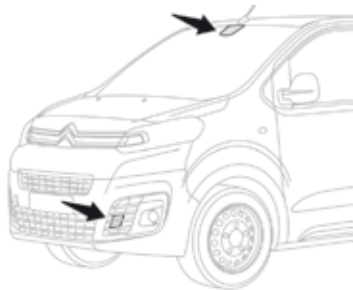

i If one of the two sensors (camera or radar) is masked or its visibility is reduced, while the other sensor is able to work normally, the system still operates, but at a lower level of performance. This is not indicated by a message or a warning lamp. To ensure correct operation of the radar radar, do not paint over the paintwork on the vehicle's bumper.

i Keep the windscreen in front of the camera clean. Do not allow snow to accumulate on the bonnet or roof of the vehicle as this could mask the camera's view.

i Clean the front bumper, removing the snow, mud, ...

Lane departure warning system



System that uses a camera to recognise continuous or broken lines on traffic lanes and triggers an alert if the vehicle wanders off line. If the direction indicator is not used at speeds above 37 mph (60 km/h) and there is a risk of one of these lines on the ground being crossed, the system triggers the alert. The system is particularly useful on motorways and fast roads.

! The lane departure warning system cannot in any circumstances replace the need for vigilance on the part of the driver. It is necessary to observe the driving regulations and to take a break every two hours.

Detection - Alert



You are alerted by the flashing of this warning lamp in the instrument panel, accompanied by an audible signal.

i No alert is given while the direction indicators are operating and for approximately 20 seconds after the direction indicators are switched off.

Activation / Deactivation

The system is activated or deactivated via the vehicle configuration menu.

With / Without audio system

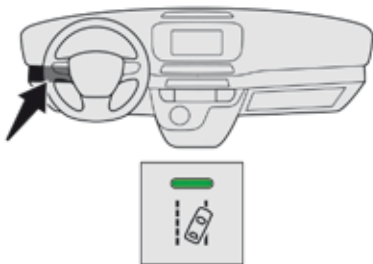

To activate the system:



☞ Press on this button, its indicator lamp comes on, the system is activated.

To deactivate the system:



☞ Press on this button, its indicator lamp goes off, the system is deactivated.

With the touch screen



In the **Driving** menu, activate/deactivate "**Lane departure warning**".

Operating fault

Depending on your vehicle's equipment:



The indicator lamp in this button flashes.

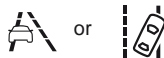

The button flashes and a fault appears.

Contact a CITROËN dealer or a qualified workshop.

- i** The detection may be impeded:
- if the markings on the ground are worn and do not contrast well with the road surface,
 - if the windscreen is dirty,
 - in certain severe weather conditions: fog, heavy rain, snow, shade, bright sunlight and direct exposure to the sun (low sun, leaving a tunnel, ...).

Fatigue detection system

It is recommended that you take a break as soon as you feel tired or at least every two hours.

Depending on version, the vehicle either has the "Driving time warning system" only, or this combined with the "Fatigue detection system".

Driving time warning

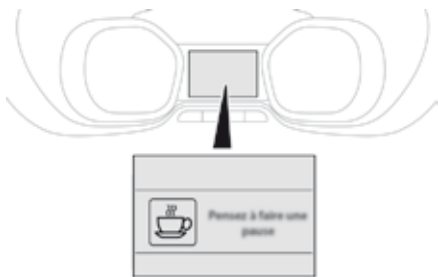

This alert takes the form of the display of a message encouraging you to take a break, accompanied by an audible signal. If the driver does not follow this advice, the alert is repeated hourly until the vehicle is stopped.

! The system triggers an alert once it detects that the driver has not taken a break after two hours of driving at a speed above 40 mph (65 km/h).

The system resets itself if one of the following conditions is met:

- engine running, the vehicle has been stationary for more than 15 minutes,
- the ignition has been switched off for a few minutes,
- the driver's seat belt is unfastened and their door is open.

i As soon as the speed of the vehicle drops below 40 mph (65 km/h), the system goes into standby. The driving time is counted again once the speed is above 40 mph (65 km/h).

! The system cannot in any circumstances replace the need for vigilance on the part of the driver. Do not take the wheel if you are tired.

Activation / Deactivation

The system is activated or deactivated via the vehicle configuration menu.

With the audio system



In the "**Personalisation-configuration**" menu, activate/deactivate "**Fatigue Detection System**".

With the touch screen



In the vehicle settings menu, activate/deactivate "**Fatigue Detection System**".

Fatigue detection system

Depending on version, the "Driving time warning system" may be combined with the "Fatigue detection system".

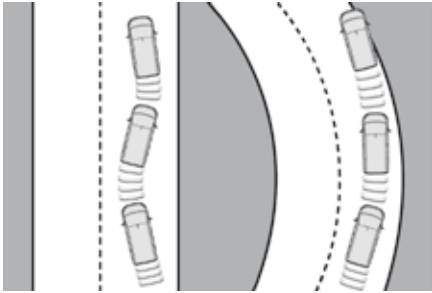

Using a camera placed at the top of the windscreen, the system assesses the driver's level of vigilance by identifying variations in trajectory compared to the lane markings. This system is particularly suited to fast roads (speed higher than 40 mph (65 km/h)).

! The system cannot, in any circumstances, replace the need for vigilance on the part of the driver. Do not drive if you are tired or taking medicines that can cause drowsiness.

Once the system considers that the behaviour of the vehicle suggests a certain level of fatigue or inattention by the driver, it triggers the first level of alert.

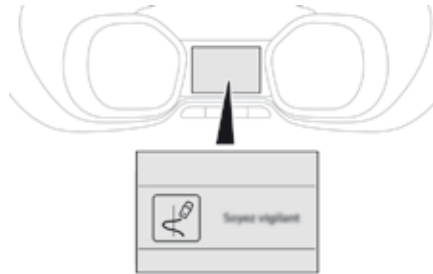

The driver is then alerted by the message "**Take care!**", accompanied by an audible signal.

After three first level alerts, the system triggers a new alert with the message "**Take a break!**", accompanied by a more pronounced audible signal.

i In certain driving conditions (poor road surface or strong winds), the system may give alerts independent of the driver's level of vigilance.

! The following situations may interfere with operation of the system or prevent it working:

- poor visibility (inadequate lighting of the roadway, falling snow, heavy rain, dense fog, ...),
- dazzle (headlamps of an oncoming vehicle, low sun, reflections on a damp road, leaving a tunnel, alternating shade and light, ...),
- windscreen area located in front of the camera: dirty, misted, frost-covered, snow-covered, damaged or covered by a sticker,
- lane markings absent, worn, masked (snow, mud) or multiple (roadworks, ...),
- close to the vehicle ahead (lane markings not detected),
- roads that are narrow, winding, ...

Blind spot monitoring system

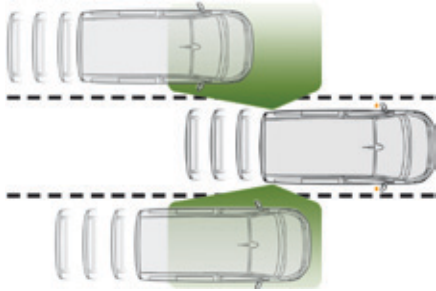

This driving assistance system warns the driver of the presence of another vehicle in the blind spot angle of their vehicle (areas masked from the driver's field of vision), as soon as this presents a potential danger.



This system is designed to improve safety when driving and is in no circumstances a substitute for the use of the interior rear view mirror and door mirrors. It is the driver's responsibility to constantly check the traffic, to assess the distances and relative speeds of other vehicles and to predict their movements before deciding whether to change lane.

The blind spot sensor system does not replace the need for vigilance on the part of the driver.



A warning lamp appears in the door mirror on the side in question:

- immediately, when being overtaken,
- after a delay of about one second, when overtaking a vehicle slowly.

The alert is given by a warning lamp which comes on in the door mirror on the side in question as soon as a vehicle - car, lorry, bicycle - is detected and the following conditions are fulfilled:

- all the vehicles must be moving in the same direction and on adjacent lanes,
- the speed of your vehicle is between 7 and 87 mph (12 and 140 km/h),
- when you overtake a vehicle with a speed difference of less than 6 mph (10 km/h),
- when a vehicle overtakes you with a speed difference of less than 15 mph (25 km/h),
- the traffic must be flowing normally,
- in the case of an overtaking manoeuvre, if this is prolonged and the vehicle being overtaken returns to the blind spot,
- you are driving on a straight or slightly curved road,
- your vehicle is not pulling a trailer, a caravan...

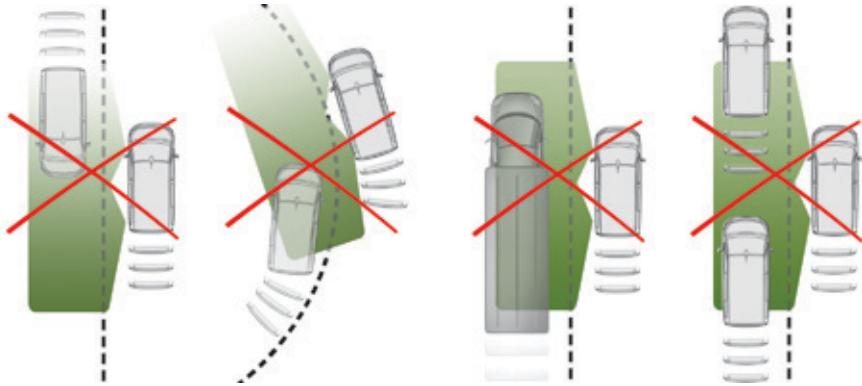

No alert will be given in the following situations:

- in the presence of immobile objects (parked vehicles, barriers, street lamps, road signs...),
- with vehicles moving in the opposite direction,
- driving on a winding road or in a sharp corner,

- when overtaking (or being overtaken by) a very long vehicle (lorry, coach...) which is at the same time detected at the rear in the blind spot angle and present in the driver's forward field of vision,
- in very heavy traffic: vehicles detected in front and behind are confused with a lorry or an immobile object,
- when overtaking quickly.

Activation / Deactivation

The system is activated or deactivated via the vehicle configuration menu.

With / Without audio system



To activate the system:



- ☞ Press on this button, its indicator lamp comes on, the system is activated.

To deactivate the system:



- ☞ Press on this button, its indicator lamp goes off, the system is deactivated.

With the touch screen



In the **Driving** menu, activate/deactivate "**Blind spot monitoring**".

i The state of the system remains in memory on switching off the ignition.

i The system is automatically deactivated when towing with a towbar approved by CITROËN.

Operating fault

Depending on your vehicle's equipment:

SERVICE or



In the event of a fault, these warning lamps flash.



The indicator lamp in this button flashes and a message appears, accompanied by an audible signal.

Have it checked by a CITROËN dealer or a qualified workshop.

i The system may suffer temporary interference in certain weather conditions (rain, hail...). In particular, driving on a wet surface or moving from a dry area to a wet area can cause false alerts (for example, the presence of a fog of water droplets in the blind spot angle is interpreted as a vehicle). In bad or wintry weather, ensure that the sensors are not covered by mud, ice or snow. Take care not to cover the warning zone in the door mirrors or the detection zones on the front and rear bumpers with adhesive labels or other objects; they may hamper the correct operation of the system.

! **High pressure jet wash**
When washing your vehicle, do not place the tip of the lance within 30 cm of the sensors as otherwise there is a risk of damaging them.

Parking sensors

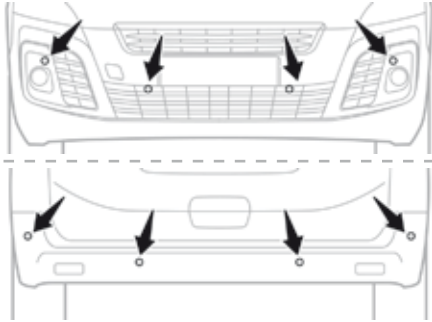

This system indicates the proximity of an obstacle (examples: pedestrian, vehicle, tree, gate) which comes within the field of detection of sensors located in the bumper. Certain types of obstacle (examples: stake, roadworks cone) detected initially will no longer be detected at the end of the manoeuvre, if they are located in blind spots in the sensors' field of detection.



This system cannot in any circumstances replace the need for vigilance on the part of the driver.

Rear parking sensors

The system is switched on by engaging reverse gear.

This is confirmed by an audible signal.

The system is switched off when you come out of reverse gear.

Audible assistance

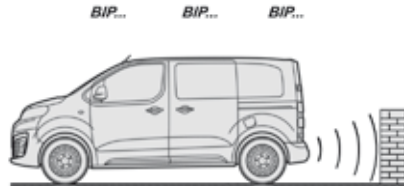

The proximity information is given by an intermittent audible signal, the frequency of which increases as the vehicle approaches the obstacle.

The sound emitted by the speaker (right or left) indicates the side on which the obstacle is located.

When the distance between the vehicle and the obstacle becomes less than approximately thirty centimetres, the audible signal becomes continuous.

Visual assistance



This supplements the audible signal by displaying bars in the screen or the instrument panel which move progressively nearer to the vehicle. When the obstacle is near, the "Danger" symbol is displayed.

Front parking sensors



As an addition to the rear parking sensors, the front parking sensors are triggered when an obstacle is detected in front and the speed of the vehicle is still below 6 mph (10 km/h).

The front parking sensors are interrupted if the vehicle stops for more than three seconds in forward gear, if no further obstacles are detected or when the speed of the vehicle exceeds 6 mph (10 km/h).

i The sound from the speakers (front or rear) indicates whether the obstacle is in front or behind.

Deactivation / Activation

Deactivation or activation of the system is done via the vehicle configuration menu.

Without audio system

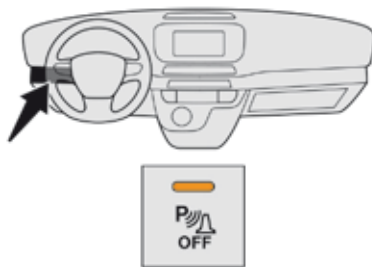

To deactivate the system:



☞ Press the button, its indicator lamp comes on, the system is deactivated.

To activate the system:



☞ Press this button, the indicator lamp goes off, the system is activated.

i The system will be automatically deactivated where a towbar or towbar-mounted bicycle carrier is fitted (vehicle fitted with a towbar installed as recommended by a CITROËN dealer).

With the audio system



In the "Personalisation-configuration" menu, activate/deactivate "Parking assistance".

With the touch screen



In the **Driving** menu, activate/deactivate "Parking sensors".

Operating fault

When engaging reverse and depending on the vehicle's equipment, in the event of a fault:

SERVICE

This warning lamp comes on and a message appears, accompanied by an audible signal.



The warning lamp in this button flashes and a message appears, accompanied by an audible signal.

Contact a CITROËN dealer or a qualified workshop.



In bad weather or in winter, ensure that the sensors are not covered with mud, ice or snow. When reverse gear is engaged, an audible signal (long beep) indicates that the sensors may be dirty. Certain sound sources (motorcycle, lorry, pneumatic drill, etc.) may trigger the audible signals of the parking sensor system.



High pressure jet wash

When washing your vehicle, do not place the tip of the lance within 30 cm of the sensors, as there is a risk of damaging them.

Reversing camera with display in the interior mirror

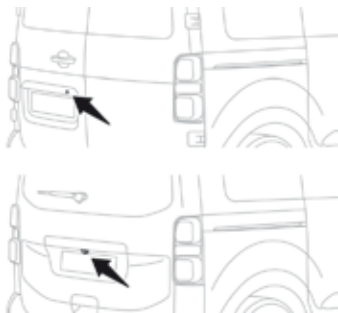

The visual aid reversing camera is activated automatically when reverse gear is engaged.

The function may be completed with parking sensors.

! The reversing camera cannot in any circumstances be a substitute for vigilance on the part of the driver.

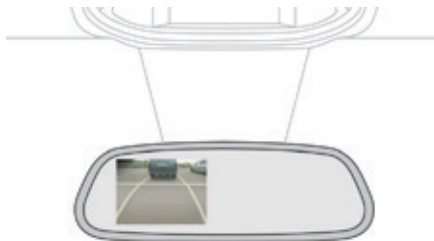

The image is displayed in the interior mirror.

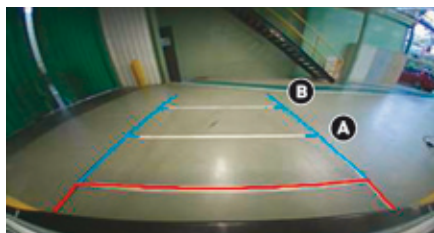

The blue lines represent the width of your vehicle including the mirrors.
The red line represents a distance of 30 cm from the rear bumper and the thin blue lines respectively 1 m (A) and 2 m (B).

i Opening the tailgate or rear door (depending on equipment) can interfere with the display.
If a side door is open, allow for the space it occupies.
Some deformation of the image is normal.

! Check the cleanliness of the camera lens regularly.
Clean the reversing camera regularly using a soft, dry cloth.

High pressure jet washing (if muddy, for example)

When washing your vehicle, do not place the tip of the lance within 30 cm of the camera as there is a risk of damaging it.

180° rear vision

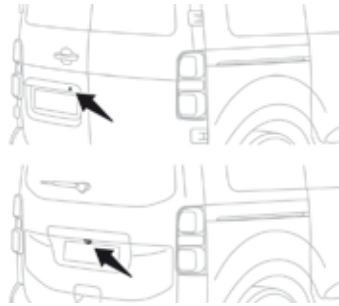

This system allows the near surroundings of the vehicle to be viewed in the display screen using cameras located at the rear of the vehicle. The parking sensors in the rear and/or front bumper complete the information on the view from above the vehicle (right-hand part).

In addition to the view from above the vehicle (right-hand part) several types of view can be displayed (left-hand part):

- standard rear view,
- 180° rear view,
- reconstructed zoom rear view.



The system displays the contextual view (left-hand part) as well as the view from above the vehicle in its close surroundings.

By default, AUTOMATIC mode is activated.

In this mode, the system chooses the best view to display (standard or zoom) according to the information received from the parking sensors. The 180° view is only available through the menus.

Principle of image reconstruction

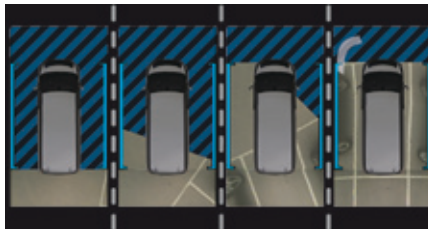

Using the rear camera, the system records the vehicle's surroundings during a manoeuvre. An image from above your vehicle in its close surroundings is reconstructed (represented between the blue brackets) in real time and as the manoeuvre progresses.

This representation facilitates the alignment of your vehicle when parking and allows you to see all of the obstacles close to the vehicle. This reconstructed view is automatically erased if the vehicle remains stationary for too long.

! This system is a visual aid and cannot in any circumstances replace the need for vigilance on the part of the driver. The images provided by the cameras may appear distorted by the surroundings (exterior conditions, driving mode, ...).

The presence of areas in shadow, bright sunlight, or poor lighting conditions may make the image dark and reduce contrast.

i The display disappears above approximately 6 mph (10 km/h). The system is automatically deactivated about 7 seconds after coming out of reverse or on opening a door or the boot.

Rear views

Engage reverse gear to activate the camera, located on the tailgate or rear door.

"Standard view"

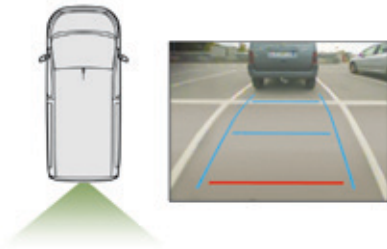

The area to the rear of your vehicle is displayed in the screen.

The blue outline represents the width of your vehicle (with mirrors): its orientation depends on the position of the steering wheel.

The red line represents a distance of 30 cm from the rear bumper and the two blue lines, 1 m and 2 m respectively.

"180° view"

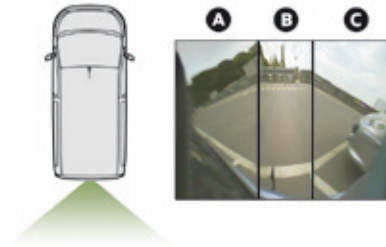

180° view makes it possible to reverse out of a parking space while being able to see the arrival of vehicles, pedestrians or cyclists. This view is not recommended for carrying out a complete manoeuvre. It is made up of the following:

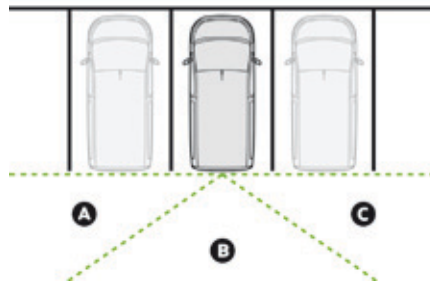

"Zoom view" (reconstructed)

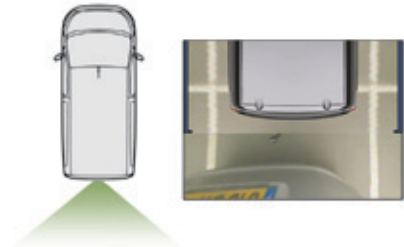

The camera records the surroundings during a manoeuvre in order to create a reconstruction of the view from above the rear of the vehicle in its close surroundings, allowing the vehicle to be manoeuvred among the obstacles nearby. This view is available with AUTO view or by selecting of the view in the change view menu.

! The rear parking sensors also provide information on the vehicle's surroundings. Obstacles may appear further away than they are in reality. It is important to check the side views using the mirrors during the manoeuvre.

"AUTO mode"

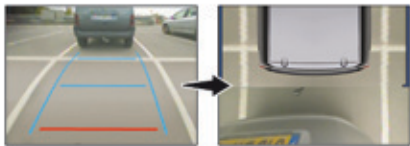

This mode is activated by default.

Using sensors in the rear bumper, the automatic view allows a change from the rear view to the view from above as an obstacle is approached during a manoeuvre.

Quick start mode

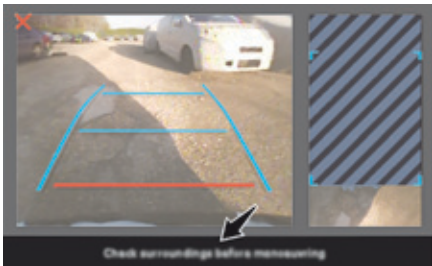

This mode displays, as quickly as possible, the contextual view (left-hand part) and the view from above the vehicle.

A message is displayed advising you to check your vehicle's surroundings before starting the manoeuvre.

Activation

Activation is automatic on engaging reverse. The function is displayed in the touch screen. To close the window displayed, press on the red cross at the top left of the screen.

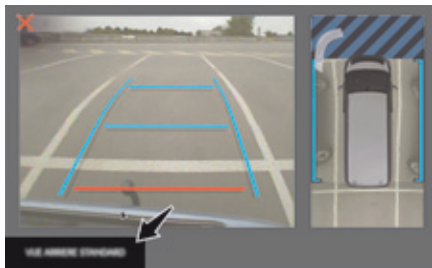

You can choose the display mode at any time by pressing on this area.

i The system is automatically deactivated when towing a trailer or carrying a bicycle on the towbar (vehicle fitted with a towbar installed as recommended by the manufacturer).

On display of the sub-menu, select one of the four views:



"Standard view".



"180° view".



"Zoom view".



"AUTO mode".



Check the cleanliness of the camera lenses regularly. Periodically clean the reversing camera with a soft dry cloth.

High pressure jet wash (if muddy, for example)

When washing your vehicle, do not place the tip of the lance within 30 cm of the camera lenses, as otherwise there is a risk of damaging them.

Under-inflation detection

System which automatically checks the pressures of the tyres while driving.

The system monitors the pressures in the four tyres, once the vehicle is moving.

It compares the information given by the four wheel speed sensors with **reference values, which must be reinitialised every time the tyre pressures are adjusted or a wheel changed.**

The system triggers an alert as soon as it detects a drop in the inflation pressure of one or more tyres.

 The under-inflation detection system does not replace the need for vigilance on the part of the driver. This system does not avoid the need to check the tyre pressures (including the spare wheel) every month as well as before a long journey. Driving with under-inflated tyres impairs road holding, extends braking distances and causes premature tyre wear, particularly under arduous conditions (high loading, high speed, long journey).

 Driving with under-inflated tyres increases fuel consumption.

 The inflation pressures defined for your vehicle can be found on the tyre pressure label. For more information on the **Identification markings**, refer to the corresponding section. Tyre pressures should be checked when the tyres are "cold" (vehicle stopped for 1 hour or after a journey of less than 6 miles (10 km) at moderate speeds). Otherwise (when hot), add 0.3 bar to the pressures shown on the label.

 **Snow chains**
The system does not have to be reinitialised after fitting or removing snow chains.

 **Spare wheel**
The steel spare wheel does not have an under-inflation detection sensor.

Under-inflation alert



This is given by fixed illumination of this warning lamp, accompanied by an audible signal and, depending on equipment, the display of a message.

- ☞ Reduce speed immediately, avoid excessive steering movements and sudden braking.
- ☞ Stop the vehicle as soon as it is safe to do so.

! The loss of pressure detected does not always cause visible bulging of the tyre. Do not satisfy yourself with just a visual check.

- ☞ In the event of a puncture, use the temporary puncture repair kit or the spare wheel (depending on equipment),
- or
- ☞ if you have a compressor, such as the one in the temporary puncture repair kit, check the pressures of the four tyres when cold,
- or
- ☞ if it is not possible to make this check immediately, drive carefully at reduced speed.

i The alert is maintained until the system is reinitialised.

Reinitialisation

It is necessary to reinitialise the system every time one or more tyre pressures are adjusted, and after changing one or more wheels.

! Before reinitialising the system, ensure that the pressures of the four tyres are correct for the use of the vehicle and in line with the recommendations on the tyre pressure label. The under-inflation alert can only be relied on if the reinitialisation of the system has been done with the pressures in the four tyres correctly adjusted. The under-inflation detection system does not give a warning if a pressure is incorrect at the time of reinitialisation.

Initialisation of the system is done with the ignition on and the vehicle stationary.

i The new pressure settings registered are considered to be reference values by the system.

Without audio system

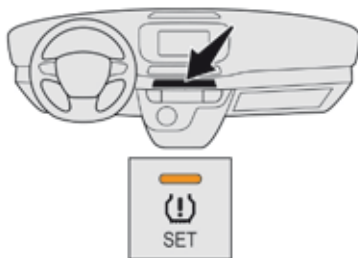

☞ Press this button for about 3 seconds then release it; an audible signal confirms the reinitialisation.

With the audio system



In the "**Personalisation-configuration**" menu, select "**Under-inflation initialisation**".

With the touch screen



In the **Driving** menu, select "**Under-inflation initialisation**".

Press on "**Yes**" to **Confirm** the command, initialisation is confirmed by an audible signal and a message.

Operating fault



The flashing and then fixed illumination of the under-inflation warning lamp accompanied by illumination of the Service warning lamp indicates a fault with the system.

In this case, under-inflation monitoring of the tyres is no longer assured. Have the system checked by a CITROËN dealer or a qualified workshop.

i Before doing anything to the system, the pressures of the four tyres must be checked and the system reinitialised.

Fuel tank

Capacity of the tank: approximately **69** litres.

Opening

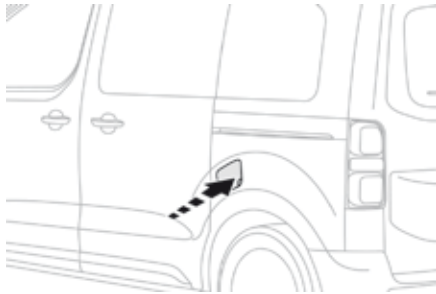

- ☞ **You must switch off the engine.**
- ☞ If your vehicle has Keyless Entry and Starting, unlock the vehicle.
- ☞ Open the filler flap.

! If your vehicle is fitted with Stop & Start, never refuel with the engine in STOP mode; you must switch off the ignition using the key, or the START/STOP button if your vehicle has Keyless Entry and Starting.

Refuelling

Additions of fuel must be of at least 8 litres to be registered by the fuel gauge. Opening the filler cap may result in an inrush of air. This vacuum is entirely normal and results from the sealing of the fuel system.

- ☞ Take care to select the pump that delivers the correct fuel type for your vehicle's engine (reminder on a label on the inside of the filler flap).

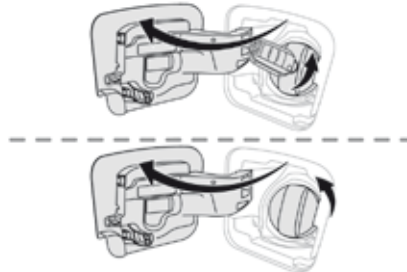

- ☞ If your vehicle has a conventional key, introduce the key into the filler cap, then turn it to the left.

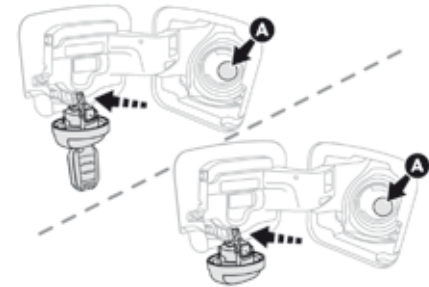

- ☞ Remove the filler cap by unscrewing it, then place it on the carrier located on the filler flap.
- ☞ Introduce the nozzle and push it in fully (pushing on the metal non-return valve **A**).
- ☞ Fill the tank. Do not continue past the third cut-off of the nozzle, as this may cause malfunctions.
- ☞ Refit the filler cap turning it to the right.
- ☞ Push the filler flap to close it (your vehicle must be unlocked).

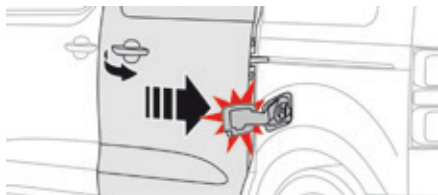

! If your vehicle has sliding side doors, do not open the left hand sliding door as there is a risk of damaging the fuel filler flap when refuelling.

Your vehicle is fitted with a catalytic converter, a device which helps to reduce the level of harmful emissions in the exhaust gases.

! If you have put in the wrong fuel for your vehicle, you must have the tank drained and refilled with the correct fuel before you start the engine.

Low fuel level



When the low fuel level in the tank is reached, this warning lamp comes on in the instrument panel, accompanied by an audible warning and a message.

When it first comes on, less than 8 litres of fuel remain in the tank.

You must refuel as soon as possible to avoid running out.

Fuel supply cut-off

Your vehicle is equipped with a safety device which cuts off the fuel supply in the event of a collision.

Diesel misfuel prevention

Mechanical device which prevents filling the tank of a Diesel vehicle with petrol. It avoids the risk of engine damage that can result from filling with the wrong fuel.

Located in the filler neck, the misfuel prevention device appears when the filler cap is removed.

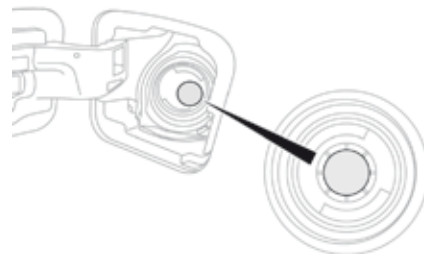

When a petrol filler nozzle is introduced into the fuel filler neck of your Diesel vehicle, it comes into contact with the flap. The system remains closed and prevents filling.

Do not persist but introduce a Diesel filler nozzle.

i It is still possible to use a fuel can to fill the tank but this must be done slowly. In order to ensure a good flow of fuel, do not place the nozzle of the fuel can in direct contact with the flap of the misfuel prevention device.

Travelling abroad

As Diesel fuel pump nozzles may be different in other countries, the presence of the misfuel prevention device may make refuelling impossible.

Before travelling abroad, we recommend that you check with the CITROËN dealer network, whether your vehicle is suitable for the fuel pumps in the country in which you want to travel.

Fuel used for Diesel engines

The Diesel engines are compatible with biofuels that conform to current and future European standards and can be obtained from filling stations:

B7

- Diesel fuel that meets standard EN590 mixed with a biofuel that meets standard EN14214 (possibly containing up to 7 % Fatty Acid Methyl Ester),

B10

- Diesel fuel that meets standard EN16734 mixed with a biofuel that meets standard EN14214 (possibly containing up to 10 % Fatty Acid Methyl Ester),

XTL

- Paraffinic Diesel fuel that meets standard EN15940 mixed with a biofuel that meets standard EN14214 (possibly containing up to 7 % Fatty Acid Methyl Ester).

B20

B30

The use of B20 or B30 fuel meeting standard EN16709 is possible in your Diesel engine. However, this use, even occasional, requires strict application of the special servicing conditions referred to as "Arduous conditions". For more information, contact a CITROËN dealer or a qualified workshop.



The use of any other type of (bio) fuel (vegetable or animal oils, pure or diluted, domestic fuel...) is strictly prohibited (risk of damage to the engine and fuel system).



The only Diesel additives authorised for use are those that meet the B715000 standard.

Snow chains

In wintry conditions, snow chains improve traction as well as the behaviour of the vehicle when braking.

i The snow chains must be fitted only to the front wheels.

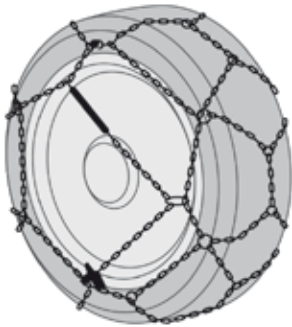

! It is strongly recommended that before you leave, you practise fitting the snow chains on a level and dry surface.

Use only the chains designed to be fitted to the type of wheel fitted to your vehicle:

| Original tyre size | Type of chain |
|--------------------|---------------------------|
| 215/65 R16 | 12 mm links |
| 215/60 R17 | KONIG K-SUMMIT VAN K84 |
| 225/55 R17 | |

You can also use snow socks.

For more information, contact a CITROËN dealer or a qualified workshop.

i Take account of the legislation in force in your country on the use of snow chains and the maximum running speed authorised.

Advice on installation

- ⚙** If you have to fit the chains during a journey, stop the vehicle on a flat surface on the side of the road.
- ⚙** Apply the parking brake and position any wheel chocks to prevent movement of your vehicle.
- ⚙** Fit the chains following the instructions provided by the manufacturer.
- ⚙** Move off gently and drive for a few moments, without exceeding 30 mph (50 km/h).
- ⚙** Stop your vehicle and check that the snow chains are correctly tightened.

i Avoid driving with snow chains on roads that have been cleared of snow, to avoid damaging your vehicle's tyres and the road surface. If your vehicle is fitted with alloy wheels, check that no part of the chain or its fixings is in contact with the wheel rim.

Towing a trailer



Your vehicle is primarily designed for transporting people and luggage, but it may also be used for towing a trailer.

i We recommend the use of genuine CITROËN towbars and their harnesses that have been tested and approved from the design stage of your vehicle, and that the fitting of the towbar is entrusted to a CITROËN dealer or a qualified workshop.
If the towbar is not fitted by a CITROËN dealer, it must still be fitted in accordance with the vehicle manufacturer's instructions.

! Driving with a trailer places greater demands on the towing vehicle and the driver must take particular care.

i For more information on **Driving advice**, particularly when towing, refer to the corresponding section.

Energy economy mode

System which manages the duration of use of certain functions to conserve a sufficient level of charge in the battery.

After the engine has stopped, you can still use functions such as the audio and telematics system, windscreen wipers, dipped beam headlamps, courtesy lamps, etc. for a maximum combined duration of about forty minutes.

Switching to economy mode

A message appears in the instrument panel screen indicating that the vehicle has switched to economy mode and the active functions are put on standby.

If a telephone call is being made at this time, it will be maintained for around 10 minutes with the Bluetooth hands-free system of your audio system.

Exiting economy mode

These functions are reactivated automatically next time the vehicle is driven.

In order to restore the use of these functions immediately, start the engine and let it run:

- for less than ten minutes, to use the equipment for approximately five minutes,
- for more than ten minutes, to use the equipment for up to approximately thirty minutes.

Let the engine run for the duration specified to ensure that the battery charge is sufficient.

Do not repeatedly and continuously restart the engine in order to charge the battery.

A flat battery prevents the engine from starting.

For more information on the **12 V battery**, refer to the corresponding section.

Load reduction mode

System which manages the use of certain functions according to the level of charge remaining in the battery.

When the vehicle is being driven, the load reduction function temporarily deactivates certain functions, such as the air conditioning, the heated rear screen...

The deactivated functions are reactivated automatically as soon as conditions permit.

Accessories

A wide range of accessories and genuine parts is available from the CITROËN dealer network. These accessories and parts are all suitable for your vehicle and benefit from CITROËN's recommendation and warranty.

i Installation of radio communication transmitters

Before installing any after-market radio communication transmitter, you can contact a CITROËN dealer for the specification of transmitters which can be fitted (frequency, maximum power, aerial position, specific installation requirements), in line with the Vehicle Electromagnetic Compatibility Directive (2004/104/EC).

i Depending on the legislation in force in the country, certain safety equipment may be compulsory: high visibility safety vests, warning triangles, breathalyzers, spare bulbs, spare fuses, fire extinguisher, first aid kit, mud flaps at the rear of the vehicle.

! The fitting of electrical equipment or accessories which are not recommended by CITROËN may result in a failure of your vehicle's electronic system and excessive electrical consumption. Contact a CITROËN dealer for information on the range of recommended equipment and accessories.

"Comfort"

Door deflectors, cigarette lighter, boot dividers, coat hanger fixed to head restraint, front and rear parking sensors, styling mudflaps, boot management system, ...

"Transport solutions"

Boot liners, roof bars, bicycle carrier on roof bars, ski carrier, roof box, towbar harness,
Tow bar, which must be fitted by CITROËN dealer or a qualified workshop.

"Styling"

Wheel trims, wheel caps, door sills, gear lever knobs, ...

"Security and safety"

Anti-theft alarm, window engraving, wheel security bolts, child seats, breathalyzer, first aid kit, warning triangle, high visibility jacket, stolen vehicle tracking system, fleet management unit, snow chains, tyre snow socks, front foglamps kit, ...

"Protection"

Mats*, seat covers compatible with lateral airbags, mud flaps, side protection rubbing strips, bumper protectors, loading area protection (on wood or plastic), rear sill finishers, rear mat,

- * To avoid any risk of jamming of the pedals:
- ensure that the mat is positioned and secured correctly,
 - never fit one mat on top of another.

"Multimedia"

Smartphone support, table support or semi-integral navigation support, range of audio systems and portable navigation systems, driving recorder, Bluetooth hands-free kit, DVD player, multimedia support, driving aids, vehicle tracking system, ...

i By visiting a CITROËN dealer, you can also obtain products for cleaning and maintenance (exterior and interior) - including ecological products in the "TECHNATURE" range, topping-up products (screenwash...), touch-up pens and paint aerosols for the exact colour of your vehicle, refills (cartridge for the temporary puncture repair kit...), ...

Range of trade equipment

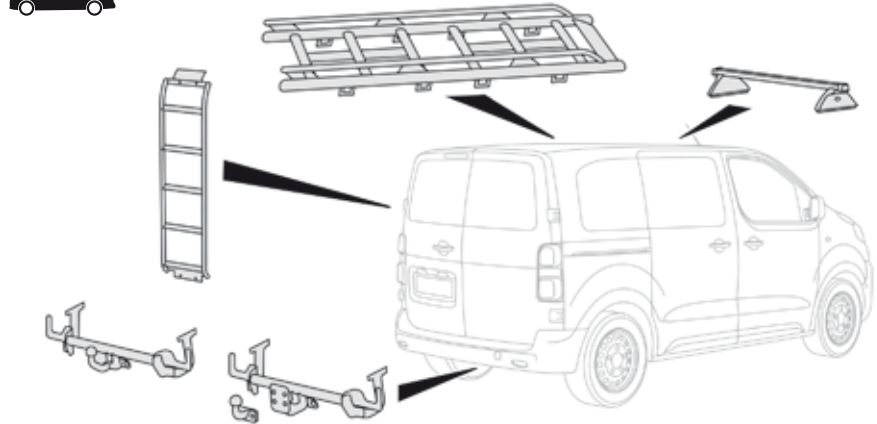

Parts and Services technical information publishes an accessory catalogue offering various equipment and fittings, such as:
Roof bars for short, medium and long wheelbase (load retainers for all models).
Sill plate, loading roller, sill.
Towbar, towbar harness.
Roof racks, roof bars, ladder.
Separation partitions and grilles, smooth, non-slip wooden protective floor.
Protective grilles, multimedia.

Another range is also available, structured around comfort, leisure and maintenance:
Anti-theft alarm, window engraving, first aid kit, high visibility safety vest, rear parking sensors, warning triangle...
Seat covers compatible with airbags for front seat, bench seat, rubber mats, carpet mats, snow chains.

To prevent the mat from becoming caught under the pedals:

- ensure that the mat and its fixings are positioned correctly,
- never fit one mat on top of another.

Audio equipment, hands-free kit, speakers, navigation...

Regardless of the audio and telematic equipment offered on the market, the technical constraints linked with the fitting of equipment of these families of products mean that the special features of the equipment and its compatibility with the capacities of the your vehicle's standard equipment must be taken into account. Please contact a dealer for information before fitting such equipment.

Front mud flaps, rear mud flaps...

Screenwash, replacement fuses, wiper blades, interior and exterior cleaning and maintenance products, replacement bulbs...

i For any work on your vehicle, use a qualified workshop that has the technical information, skills and equipment required, all of which a CITROËN dealer is able to provide.

Roof bars / Roof rack

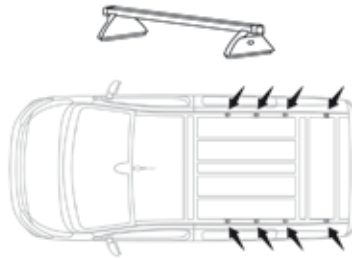

To fit the transverse roof bars, use the fixing points provided for this purpose:

- ☞ open the fixing covers on each bar,
- ☞ put each fixing in place and lock them on the roof one by one,
- ☞ ensure that roof bars are correctly fitted (by shaking them),
- ☞ close the fixing covers on each bar.

The bars can be interchanged and are adaptable to each pair of fixing points.



Be sure to refer to national legislation in order to comply with the regulations for transporting objects that are longer than the vehicle.

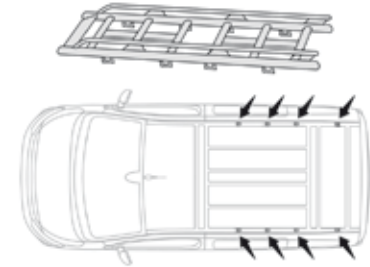

To fit a roof rack, use the fixing points provided for this purpose:

- ☞ place the roof rack on the roof aligned with the fixing points and secure each one in turn,
- ☞ ensure that roof rack is correctly fitted (by shaking it).

i Maximum authorised weight on **each fixing point**, for a loading height not exceeding 40 cm: **25 kg**.

Maximum weight by vehicle size:

- compact (L1) with 8 fixing points: 200 kg
- standard (L2) and long (L3) with 10 fixing points: 250 kg

If the height exceeds 40 cm, adapt the speed of the vehicle to the profile of the road to avoid damaging the roof rack or roof bars and the fixing points on the roof.

Changing a wiper blade

Before removing a front wiper blade

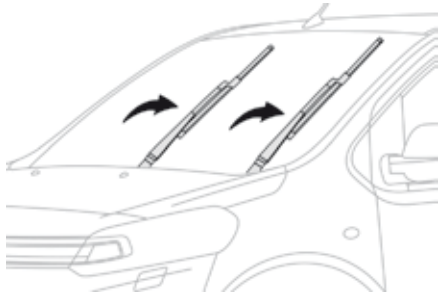

- ☞ Within one minute after switching off the ignition, operate the wiper stalk to position the wiper blades vertically on the windscreen.

Removing

- ☞ Raise the corresponding wiper arm.
- ☞ Unclip the wiper blade and remove it.

Fitting

- ☞ Put the corresponding new wiper blade in place and clip it.
- ☞ Fold down the wiper arm carefully.

After fitting a front wiper blade

- ☞ Switch on the ignition.
- ☞ Operate the wiper stalk again to park the wiper blades.

TOTAL & CITROËN

Partners in performance and protecting the environment

Innovation in the search for performance

For over 40 years, the TOTAL Research and Development departments have developed lubricants for CITROËN, to match the latest technical innovations on CITROËN vehicles, both for competition and for everyday motoring.

For you, this is an assurance that you will obtain the best performance from your engine.

Optimum protection for your engine

By having your CITROËN vehicle serviced with TOTAL lubricants, you are contributing towards improving the life and performance of your engine, while also protecting the environment.



7



CITROËN prefers **TOTAL**



Bonnet



! Before doing anything under the bonnet, deactivate the Stop & Start system to avoid any risk of injury resulting from an automatic change to START mode.

! Do not open the bonnet under very windy conditions.
When the engine is hot, handle the exterior safety catch and the stay with care (risk of burns).
To avoid damaging electrical units, it is strictly **forbidden** to use a high pressure jet wash under the bonnet.

Opening

☞ Open the door.

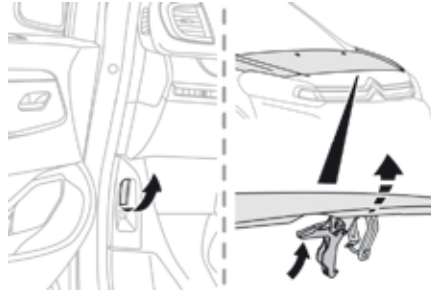

- ☞ Pull the release lever, located at the bottom of the door aperture, towards you.
- ☞ Lift the safety catch, then raise the bonnet.

! **The cooling fan may start after switching off the engine: take care with articles and clothing that might be caught by the fan blades.**

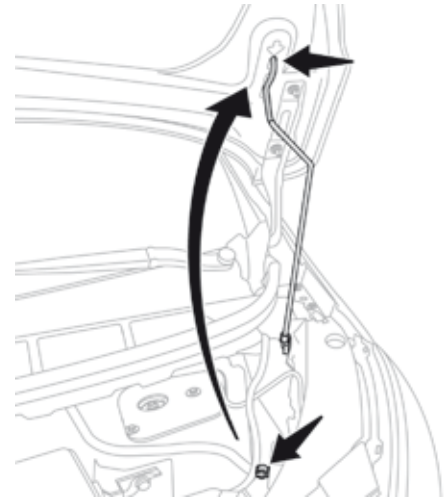

- ☞ Unclip the stay from its housing and place it in the support slot to hold the bonnet open.

Closing

- ☞ Take the stay out of its support slot.
- ☞ Clip the stay back into its housing.
- ☞ Lower the bonnet and release it at the end of its travel.
- ☞ Pull on the bonnet to check that it has latched correctly.

Diesel engine

1. Screenwash and headlamp wash reservoir.
2. Coolant header tank.
3. Engine oil filler cap.
4. Engine oil dipstick.
5. Priming pump*.
6. Brake fluid filler cap.
7. Battery.
8. Remote earth point ("-" terminal).
9. Fusebox.
10. Power steering fluid reservoir.
11. Air filter.

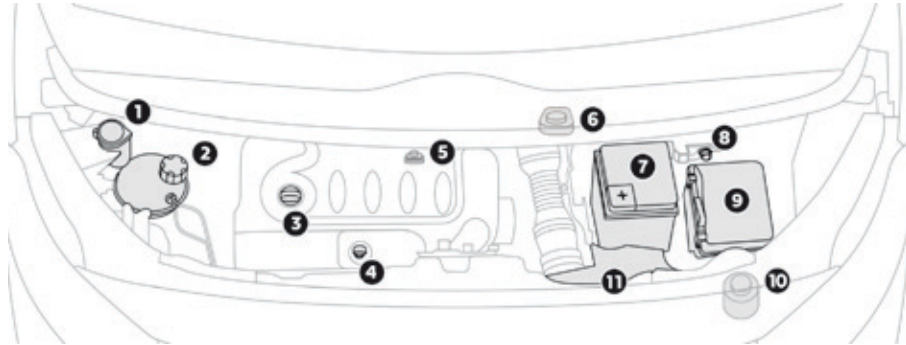

This engine is shown as an example. The locations of the engine oil dipstick and filler cap may vary.

- !** The Diesel fuel system operates under high pressure:
- Never carry out any work on this system yourself.
 - HDi engines make use of advanced technology.
- All maintenance and repairs require specially trained staff, which only a CITROËN dealer can provide.

* According to engine.

Checking levels

Check all of these levels regularly, in line with the manufacturer's service schedule. Top them up if necessary, unless otherwise indicated. If a level drops significantly, have the corresponding system checked by a CITROËN dealer or a qualified workshop.

! Take care when working under the bonnet, as certain areas of the engine may be extremely hot (risk of burns) and the cooling fan could start at any time (even with the ignition off).

Engine oil level



The check is carried out either when the ignition is switched on using the oil level indicator in the instrument panel for vehicles so equipped, or using the dipstick.

To ensure that the reading is correct, your vehicle must be parked on a level surface with the engine having been off for more than 30 minutes.

It is normal to top-up the oil level between two services (or oil changes). CITROËN recommends that you check the level, and top-up if necessary, every 3 000 miles (5 000 kms).

Checking using the dipstick

The location of the dipstick is shown in the corresponding underbonnet layout view.

- ☞ Take the dipstick by its coloured grip and remove it completely.
- ☞ Wipe the end of the dipstick using a clean non-fluffy cloth.
- ☞ Refit the dipstick and push fully down, then pull it out again to make the visual check: the correct level is between the marks **A** and **B**.

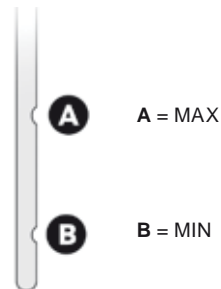

If you find that the level is above the **A** mark or below the **B** mark, **do not start the engine**.

- If the level is above the **MAX** mark (risk of damage to the engine), contact a CITROËN dealer or a qualified workshop.
- If the level is below the **MIN** mark, you must top-up the engine oil.

Oil grade

Before topping-up the oil or changing the oil, check that the oil is the correct grade for your engine and conforms to the manufacturer's recommendations.

Topping-up the engine oil level

The location of the oil filler cap is shown in the corresponding underbonnet layout view.

- ☞ Unscrew the oil filler cap to reveal the filler aperture.
- ☞ Add oil in small quantities, avoiding any spills on engine components (risk of fire).
- ☞ Wait a few minutes before checking the level again using the dipstick.
- ☞ Add more oil if necessary.
- ☞ After checking the level, carefully refit the oil filler cap and the dipstick in its tube.

i After topping-up the oil, the check when switching on the ignition with the oil level indicator in the instrument panel is not valid during the 30 minutes after topping-up.

Engine oil change

Refer to the manufacturer's service schedule for details of the interval for this operation. In order to maintain the reliability of the engine and emission control system, never use additives in the engine oil.

Brake fluid level



The brake fluid level should be close to the "MAX" mark. If it is not, check the brake pad wear.

Changing the fluid

Refer to the manufacturer's service schedule for details of the interval for this operation.

Fluid specification

The brake fluid must conform to the manufacturer's recommendations.

Power steering fluid level



The power steering fluid level should be close to the "MAX" mark. With the engine cold, unscrew the cap to check the level.

Coolant level



The coolant level should be close to the "MAX" mark but should never exceed it.

When the engine is warm, the temperature of the coolant is regulated by the fan.

The cooling fan may start after switching off the engine: take care with articles and clothing that might be caught by the fan blades.

In addition, as the cooling system is pressurised, wait at least one hour after switching off the engine before carrying out any work.

To avoid any risk of scalding, unscrew the cap by two turns to allow the pressure to drop. When the pressure has dropped, remove the cap and top up the level.

Check the coolant level regularly, according to the use made of your vehicle (every 3 000 miles or 5 000 kms / 3 months); if necessary, top-up using coolant recommended by the manufacturer.

Topping-up the coolant between services is normal.

! The check and top-up must be done with the engine cold.
A low coolant level presents the risk of serious damage to your engine.

i If the ambient temperature is high, it is recommended that the engine be allowed to idle for 1 to 2 minutes after the vehicle comes to a stop, to facilitate its cooling.

Changing the coolant

The coolant does not have to be replaced at routine services.

Fluid specification

The coolant must conform to the manufacturer's recommendations.

Screenwash and headlamp wash fluid



In the case of vehicles fitted with headlamp washers, the low fluid level is indicated by an audible signal and a message in the instrument panel screen.

Top up the reservoir when you next stop the vehicle.

Fluid specification

For optimum cleaning and to avoid freezing, this fluid must not be topped up with or replaced with plain water.

In wintry conditions, the use of an ethyl alcohol or methanol base fluid is recommended.

Diesel additive level (Diesel engine with particle filter)

SERVICE

A low additive level is indicated by illumination of this warning lamp, accompanied by an audible warning and a message in the instrument panel screen.

Topping-up

This additive must be topped-up by a CITROËN dealer or a qualified workshop without delay.

Used products

! Avoid prolonged contact of used oil or fluids with the skin.
Most of these fluids are harmful to health or indeed very corrosive.



Do not discard used oil or fluids into sewers or onto the ground.
Take used oil to a CITROËN dealer or a qualified workshop (France) or to an authorised waste disposal site.

Checks

Unless otherwise indicated, check these components in accordance with the manufacturer's service schedule and according to your engine. Otherwise, have them checked by a CITROËN dealer or a qualified workshop.

12 V battery



The battery does not require any maintenance. However, check regularly that the terminals are correctly tightened (versions without quick release terminals) and that the connections are clean.

For more information and the precautions to take before starting work on the **12 V battery**, refer to the corresponding section.



Versions equipped with Stop & Start are fitted with a 12 V lead-acid battery of specific technology and specification. Its replacement should be carried out only by a CITROËN dealer or a qualified workshop.

Air filter and passenger compartment filter



Refer to the manufacturer's service schedule for details of the replacement intervals for these components.

Depending on the environment (e.g. dusty atmosphere) and the use of the vehicle (e.g. city driving), **replace them twice as often if necessary**.

A clogged passenger compartment filter may have an adverse effect on the performance of the air conditioning system and generate undesirable odours.

Oil filter



Replace the oil filter each time the engine oil is changed. Refer to the manufacturer's service schedule for details of the replacement interval for this component.

Particle filter (Diesel)

SERVICE

The start of saturation of the particle filter is indicated by the temporary illumination of this warning lamp accompanied by a message in the multifunction screen.



As soon as the traffic conditions permit, regenerate the filter by driving at a speed of at least 40 mph (60 km/h) until the warning lamp goes off. If the warning lamp stays on, this indicates a low additive level. For more information on **Checking levels**, refer to the corresponding section.

On a new vehicle, the first particle filter regeneration operations may be accompanied by a "burning" smell, which is perfectly normal. Following prolonged operation of the vehicle at very low speed or at idle, you may, in exceptional circumstances, notice the emission of water vapour at the exhaust on acceleration. This does not affect the behaviour of the vehicle or the environment.

Manual gearbox



The gearbox does not require any maintenance (no oil change). Refer to the manufacturer's service schedule for the checking interval for this component.

Automatic gearbox



The gearbox does not require any maintenance (no oil change). Refer to the manufacturer's service schedule for the checking interval for this component.

Electronic gearbox



The gearbox does not require any maintenance (no oil change). Refer to the manufacturer's service schedule for the checking interval for this component.

Parking brake



If excessive travel or a loss of effectiveness of this system is noticed, the parking brake must be checked, even between two services.

Checking this system must be done by a CITROËN dealer or a qualified workshop.

Brake pads



Brake wear depends on the style of driving, particularly in the case of vehicles used in town, over short distances. It may be necessary to have the condition of the brakes checked, even between vehicle services. Unless there is a leak in the circuit, a drop in the brake fluid level indicates that the brake pads are worn.

Brake disc wear



For information on checking brake disc wear, contact a CITROËN dealer or a qualified workshop.

! Only use products recommended by CITROËN or products of equivalent quality and specification. In order to optimise the operation of units as important as those in the braking system, CITROËN selects and offers very specific products. After washing the vehicle, dampness, or in wintry conditions, ice can form on the brake discs and pads: braking efficiency may be reduced. Make light brake applications to dry and defrost the brakes.

AdBlue® and SCR system for BlueHDi Diesel engines

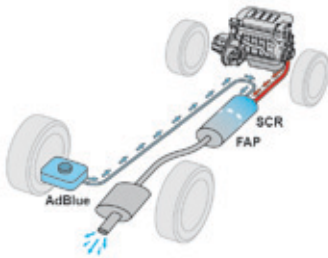

To assure respect for the environment and conformity with the new Euro 6 emissions standard, without adversely affecting the performance or fuel consumption of Diesel engines, CITROËN has taken the decision to equip its vehicles with an effective system that associates SCR (Selective Catalytic Reduction) with a particle filter (FAP) for the treatment of exhaust gases.

Presentation of the SCR system

Using a fluid called AdBlue® containing urea, a catalytic converter turns up to 85% of nitrogen oxides (NOx) into nitrogen and water, which are harmless to health and the environment.

The AdBlue® is held in a special tank with a capacity of about 22 litres: this provides a driving range of about 12 500 miles (20 000 km), after which an alert is triggered warning you when the reserve remaining is enough for just 1 500 miles (2 400 km).

i When filling the tank, the filling rate must not exceed 40 litres per minute.

During each scheduled service of your vehicle by a CITROËN dealer or a qualified workshop, the AdBlue® tank is refilled in order to allow normal operation of the SCR system.

If the estimated mileage between two services is greater than 12 500 miles (20 000 km), we recommend that you go to a CITROËN dealer or a qualified workshop to have the necessary top-up carried out.

! Once the AdBlue® tank is empty, a system required by regulations prevents starting of the engine. If the SCR is faulty, the level of emissions from your vehicle will no longer meet the Euro 6 standard: your vehicle becomes polluting. In the event of a confirmed fault with the SCR system, you must go to a CITROËN dealer or a qualified workshop as soon as possible: after a running distance of 650 miles (1 100 km), a system will be triggered automatically to prevent engine starting.

Topping-up the AdBlue®

Filling the AdBlue® tank is an operation included in every routine service on your vehicle by a CITROËN dealer or a qualified workshop.

Nevertheless, given the capacity of the tank, it may be necessary to top-up the fluid between services, more particularly if an alert (warning lamps and a message) signals the requirement. You can go to a CITROËN dealer or a qualified workshop.

If you envisage topping-up yourself, please read the following warnings carefully.

! Important

If your vehicle's AdBlue® tank is completely empty (which is confirmed by the alert messages and the impossibility of starting the engine) you must add at least 3.8 litres (so two 1.89 litre bottles).

Precautions in use

AdBlue® is a urea-based solution. This liquid is non-flammable, colourless and odourless (kept in a cool area).

In the event of contact with the skin, wash the affected area with soap and water. In the event of contact with the eyes, wash (irrigate) the eyes with large amounts of water or with an eye wash solution for at least 15 minutes. If a burning sensation or irritation persists, get medical attention.

If swallowed, immediately wash out the mouth with clean water and then drink plenty of water. In certain conditions (high ambient temperature, for example), the risk of release of ammonia cannot be excluded: do not inhale the fluid. Ammonia vapour has an irritant effect on mucous membranes (eyes, nose and throat).

! Keep AdBlue® out of the reach of children, in its original bottle. Never transfer AdBlue® to another container: it would lose its purity.

Use only AdBlue® fluid that meets the ISO 22241 standard.

! Never dilute AdBlue® with water. Never pour AdBlue® into the Diesel fuel tank.



AdBlue®

The supply in a non-drip bottle simplifies topping-up. You can obtain 1.89 litre (half a US gallon) bottles from a CITROËN dealer or a qualified workshop.

! Never top-up from an AdBlue® dispenser reserved for heavy goods vehicles.

Recommendations on storage

AdBlue® freezes at about -11°C and deteriorates above 25°C. It is recommended that bottles be stored in a cool area and protected from direct sunlight.

Under these conditions, the fluid can be kept for at least a year.

If the additive has frozen, it can be used once it has completely thawed out.

! Never store bottles of AdBlue® in your vehicle.

♻️ Do not dispose of AdBlue® bottles in the household waste. Place them in a container provided for this purpose or take them to your dealer.

i In wintry conditions, ensure that the temperature of the vehicle is above -11°C. Otherwise the AdBlue® may be frozen and so cannot be poured into its tank. Park your vehicle in a warmer area for a few hours to allow the top-up to be carried out.

Procedure

Before starting the top-up procedure, ensure that the vehicle is parked on a flat and level surface.

- ☞ Switch off the ignition and remove the key, or if your vehicle has one, press the START/STOP button to switch off the engine.

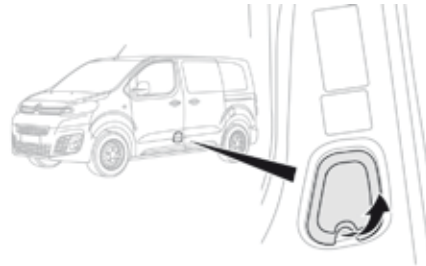

- ☞ For access to the AdBlue® tank, open the left-hand front door.
- ☞ From below, pull the black cover.

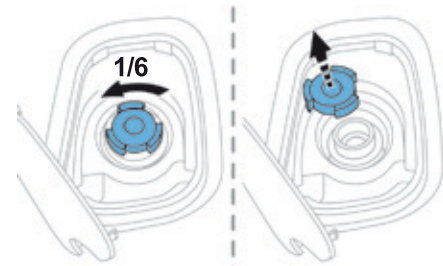

- ☞ Turn the blue cap a 6th of a turn anti-clockwise.
- ☞ Lift off the cap.



☞ Obtain a bottle of AdBlue®. After first checking the use-by date, read carefully the instructions on use on the label before pouring the contents of the bottle into your vehicle's AdBlue® tank.

☞ After emptying the bottle, wipe away any spillage around the tank filler using a damp cloth.

i Freezing of the AdBlue®

AdBlue® freezes at temperatures below around -11°C.

The SCR system includes a heater for the AdBlue® tank, allowing you to continue driving in very cold conditions.

! If any additive is split or splashed, wash immediately with cold water or wipe with a damp cloth.
If the additive has crystallised, clean it off using a sponge and hot water.

☞ Refit the blue cap to the tank and turn it a 6th of a turn clockwise, to its stop.

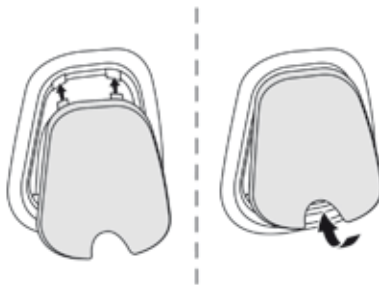

☞ Refit the black cover, starting at the top.
☞ Close the door.

! Important: **when topping-up after running out of additive**, signalled by the message "Top up emissions additive: Starting prevented", you must wait for about 5 minutes before switching the ignition on again, **without opening the driver's door, unlocking the vehicle, introducing the remote control key into the ignition switch, or placing the electronic key of the "Keyless Entry and Starting" system inside the vehicle.**

Switch on the ignition, then wait for 10 seconds before starting the engine.

Warning triangle (stowing)

This safety equipment should be used in addition to the hazard warning lamps. Its presence in the vehicle is mandatory.

! Before leaving your vehicle to set up and install the triangle, switch on the hazard warning lamps and put on your high visibility vest.

Placing the triangle in the road

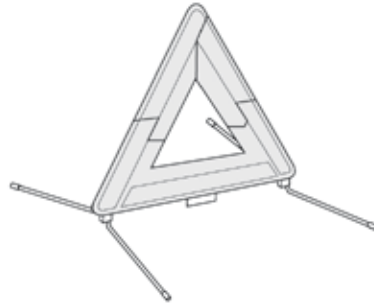

☞ Place the triangle behind the vehicle, as required by the legislation in force in your country.

Refer to the manufacturer's instructions on unfolding and assembly supplied with the triangle.

i The triangle is available as an accessory; contact a CITROËN dealer or a qualified workshop.

Tool box

Access

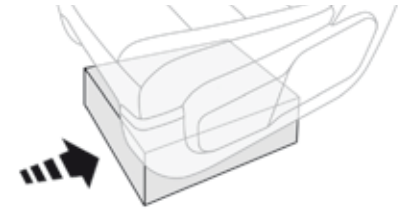

The tool box is located under the left-hand front seat.

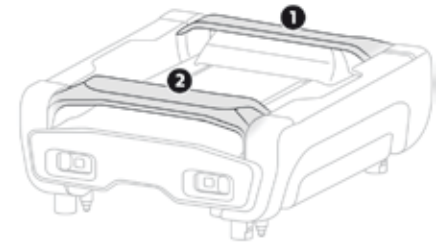

i As a safety measure, the bars **1** and **2** prevent the box escaping from its housing, if it is not correctly secured.

Removing

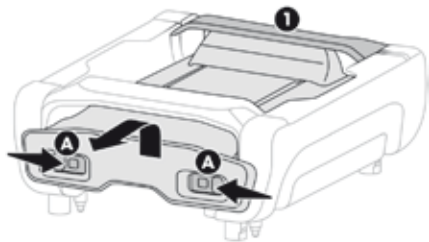

- ☞ Press the latches **A** and slide them inwards to release the box.
- ☞ Lift the box slightly then pull it as far as it will go to take it past bar **1**.

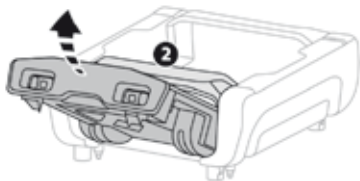

- ☞ Then, lift the box upwards to take it past bar **2**.

Opening

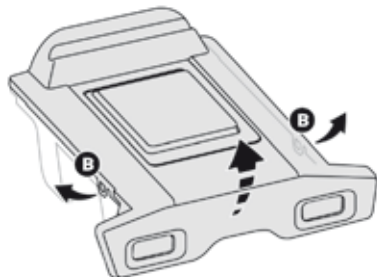

- ☞ Unclip the fixings **B** on the cover, then open it for access to the tools.

Stowing

- ☞ Refit the cover on the box and clip the fixings **B**.

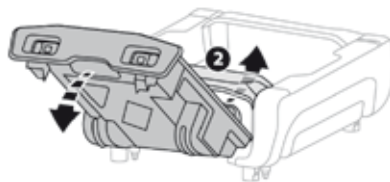

- ☞ Offer up the box with the front inclined upwards.
- ☞ To take it past bar **2**, push the box in and down.

- ☞ To take it past bar **1**, raise the box slightly then push it fully in.

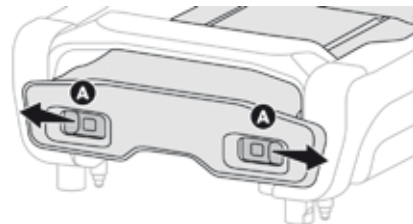

- ☞ Once the box is **fully home** in its housing, push it against the floor carpet then slide the latches **A** outwards to secure it.

i Pull on the box to check that it is secure in its housing.

If your vehicle is equipped with a temporary puncture repair kit

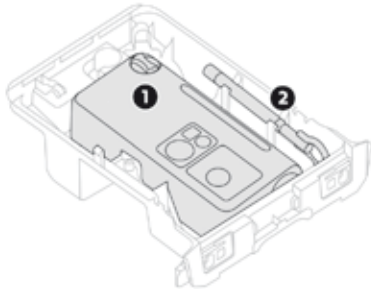

1. 12 V compressor.
To temporarily repair a tyre using an integral sealant cartridge and adjust the tyre pressure.
2. Towing eye.

If your vehicle is equipped with a spare wheel

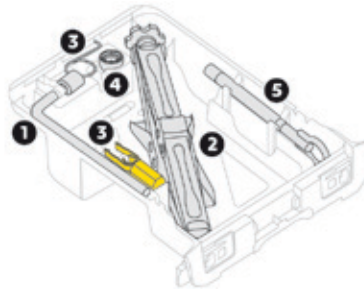

1. Wheelbrace.
For removing the wheel bolts and raising/lowering the jack.
2. Jack.
For raising the vehicle.
3. Wheel bolt cap/wheel trim removal tools.
If your vehicle is so equipped, for removing the wheel bolt head covers on alloy wheels or the wheel trim on steel wheels.
4. Security bolt socket.
For adapting the wheelbrace to the special "security" bolts.
5. Towing eye.

i These tools are specific to your vehicle and can vary according to equipment. Do not use them for other purposes.

Temporary puncture repair kit

This kit consists of a compressor and a sealant cartridge.

It allows the **temporary repair** of a tyre.

You are then able to go to the nearest garage. It is designed to repair most punctures which could affect the tyre, located on the tyre tread or shoulder.

Its compressor can be used to check and adjust the pressure of the tyre.

Access to the kit

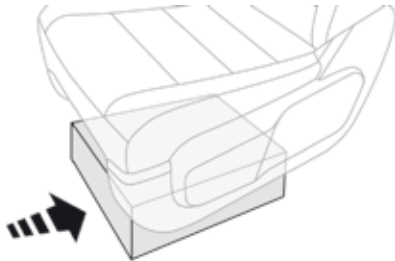

This kit is stowed in the tool box.

i For more information on the **Tool box**, refer to the corresponding section.

List of tools

These tools are specific to your vehicle and can vary according to equipment. Do not use them for other purposes.

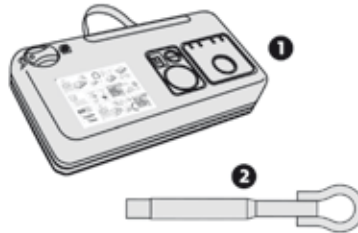

1. 12 V compressor.
To temporarily repair a tyre using an integral sealant cartridge and adjust the tyre pressure.
2. Towing eye.

i For more information on **Towing**, refer to the corresponding section.

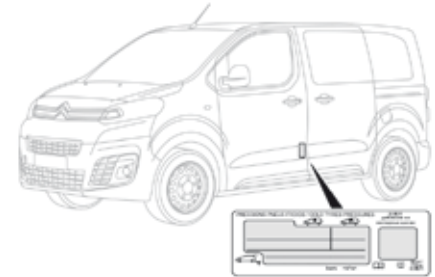

The tyre inflation pressures are given on this label.

! The vehicle's electric system allows the connection of the compressor for long enough to inflate a tyre after a puncture repair.
Use only the two 12 V sockets located at the **front** to connect your compressor.

Description of the kit

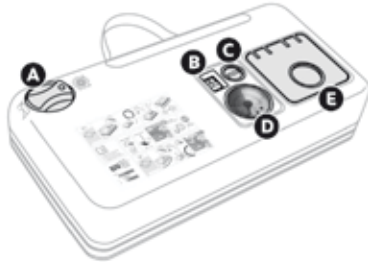

- A. "Sealant" or "Air" position selector.
- B. On "I" / off "O" switch.
- C. Deflation button.
- D. Pressure gauge (in bars and psi).
- E. Compartment housing a cable with an adaptor for a 12 V socket.

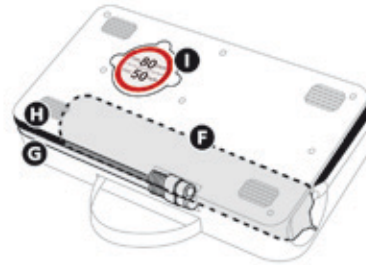

- F. Sealant cartridge.
- G. White pipe with cap for repair.
- H. Black pipe for inflation.
- I. Speed limit sticker.

i The speed limit sticker **I** must be affixed to the vehicle's steering wheel to remind you that a wheel is in temporary use. Do not exceed a speed of 50 mph (80 km/h) when driving with a tyre repaired using this type of kit.

Repair procedure

1. Sealing

- ☞ Switch off the ignition.

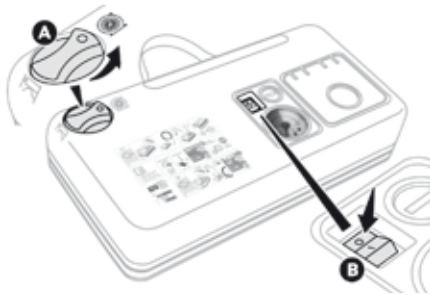

- ☞ Turn the selector **A** to the "sealant" position.

- ☞ Check that the switch **B** is in position "O".

i Avoid removing any foreign bodies which have penetrated into the tyre.

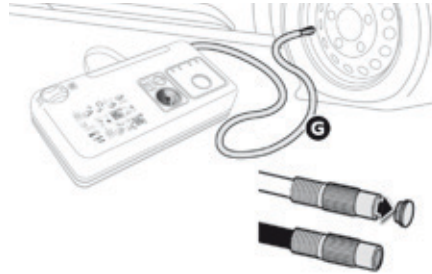

- ☞ Uncoil the white pipe **G** fully.
- ☞ Unscrew the cap from the white pipe.
- ☞ Connect the white pipe to the valve of the tyre to be repaired.

! Take care, this product is harmful if swallowed and causes irritation to the eyes. Keep this product out of the reach of children.



- ☞ Connect the compressor's electric plug to the vehicle's 12 V socket.
- ☞ Start the vehicle and leave the engine running.

! Do not start the compressor before connecting the white pipe to the tyre valve: the sealant product would be expelled through the pipe.

2. Inflation



- ☞ Switch on the compressor by moving the switch **B** to position "I" until the tyre pressure reaches 2.0 bars. The sealant is injected into the tyre under pressure; do not disconnect the pipe from the valve during this operation (risk of splashing).

i If after around 5 to 7 minutes the pressure is not attained, this indicates that the tyre is not repairable; contact a CITROËN dealer or a qualified workshop for assistance.

- ☞ Remove the kit and screw the cap back on the white pipe. Take care to avoid staining your vehicle with traces of fluid. Keep the kit to hand.

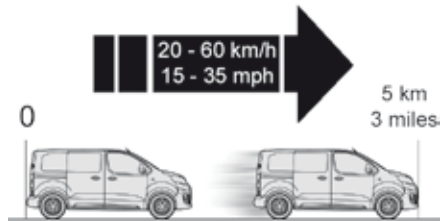

- ☞ Drive immediately for approximately three miles (five kilometres), at reduced speed (between 15 and 35 mph (20 and 60 km/h)), to plug the puncture.
- ☞ Stop to check the repair and the tyre pressure using the kit.



- ☞ Turn the selector **A** to the "Air" position.

- ☞ Uncoil the black pipe **H** fully.
- ☞ Connect the black pipe to the valve of the wheel.



- ☞ Connect the compressor's electric plug to the vehicle's 12 V socket.
- ☞ Start the vehicle again and leave the engine running.

! As soon as possible, go to a CITROËN dealer or a qualified workshop. You must inform the technician that you have used this kit. After inspection, the technician will advise you on whether the tyre can be repaired or if it must be replaced.

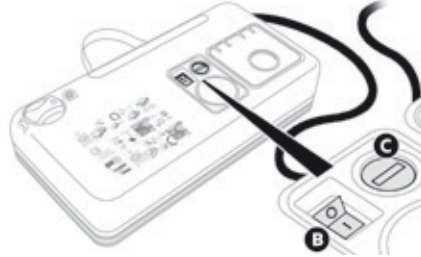

- ☞ Adjust the pressure using the compressor (to inflate: switch **B** in position "I"; to deflate: switch **B** in position "O" and press button **C**), in accordance with the vehicle's tyre pressure label (located on the left hand door aperture).
A loss of pressure indicates that the puncture has not been fully plugged; contact a CITROËN dealer or qualified workshop for assistance.
- ☞ Remove and stow the kit.
- ☞ Drive at reduced speed (50 mph [80 km/h] max) limiting the distance travelled to approximately 120 miles (200 km).

Removing the cartridge

- ☞ Stow the black pipe.
- ☞ Detach the angled base from the white pipe.
- ☞ Support the compressor vertically.

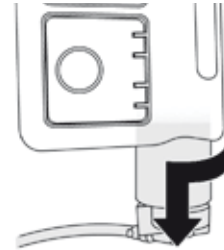

- ☞ Unscrew the cartridge from the bottom.

! Beware of discharges of fluid. The expiry date of the fluid is indicated on the cartridge. The sealant cartridge is designed for single use; even if only partly used, it must be replaced. After use, do not discard the cartridge into the environment, take it to an authorised waste disposal site or a CITROËN dealer. Do not forget to obtain a new sealant cartridge, available from CITROËN dealers or from a qualified workshop.

Checking / adjusting tyre pressures

You can also use the compressor without injecting any product, to check and if necessary adjust your tyre pressures.



☞ Turn the selector **A** to the "Air" position.

- ☞ Uncoil the black pipe **H** fully.
- ☞ Connect the black pipe to the tyre valve.



- ☞ Connect the compressor's electrical connector to the vehicle's 12 V socket.
- ☞ Start the vehicle and let the engine run.
- ☞ Adjust the pressure using the compressor (to inflate: switch **B** in position "I"; to deflate: switch **B** in position "O" and press button **C**), according to the vehicle's tyre pressure label.
- ☞ Remove the kit then stow it.

! Should the pressure of one or more tyres be adjusted, it is necessary to reinitialise the under-inflation detection system.
For more information on **Under-inflation detection**, refer to the corresponding section.

Changing a wheel

Access to the tooling

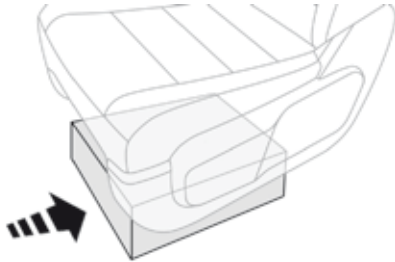

The tools are stowed in the tool box.

i For more information on the **Tool box**, refer to the corresponding section.

List of tools

These tools are specific to your vehicle and can vary according to the level of equipment. Do not use them for other purposes.

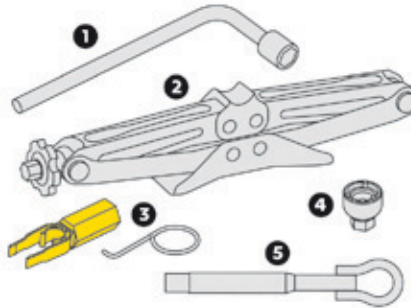

1. Wheelbrace.
For removing the wheel bolts and raising/lowering the jack.
2. Jack.
For raising the vehicle.
3. Wheel bolt cap/wheel trim removal tool.
If your vehicle is so equipped, for removing the wheel bolt head covers on alloy wheels or the central wheel trim on steel wheels.
4. Socket for the security bolts.
For adapting the wheelbrace to the special "security" bolts.
5. Towing eye.

i For more information on **Towing**, refer to the corresponding section.

i The jack must only be used to change a wheel with a damaged tyre.
The jack does not require any maintenance.

The jack conforms to European legislation, such as defined in the Machinery Directive 2006/42/CE.

Access to the spare wheel

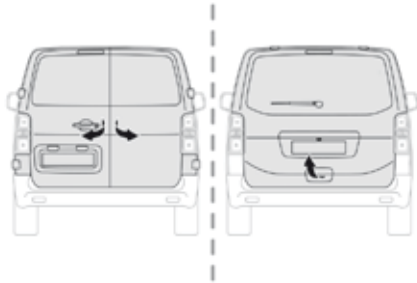

- ☞ Access to the spare wheel is from the rear.
- ☞ Open the side-hinged rear doors or the tailgate, according to the configuration of your vehicle.



- ☞ If your vehicle is fitted with a towbar, raise the rear of the vehicle using the jack (must be at jacking point **B**) to allow sufficient space to remove the spare wheel.

Removing

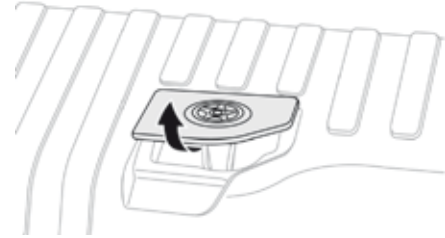

- ☞ Access the carrier bolt, located on the rear door sill.

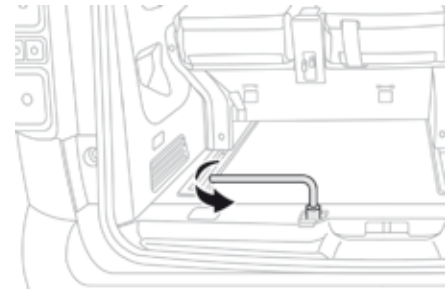

- ☞ Turn the bolt anti-clockwise using the wheelbrace (about 14 turns) until the carrier is low enough to allow the carrier hook to be disengaged.

i To avoid any unwanted opening of the electric side door(s), deactivate the "**Hands-Free Access**" function in the vehicle configuration menu. For more information on the **Hands-free sliding side door**, refer to the corresponding section.

In the event of a breakdown

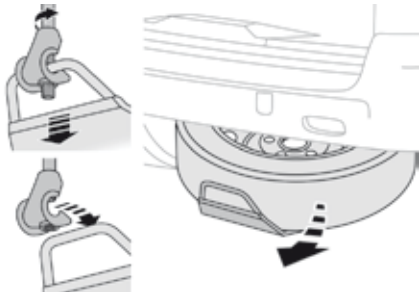

- ☞ Release the carrier from the hook, take the spare wheel and place it next to the wheel to be changed.

Refitting

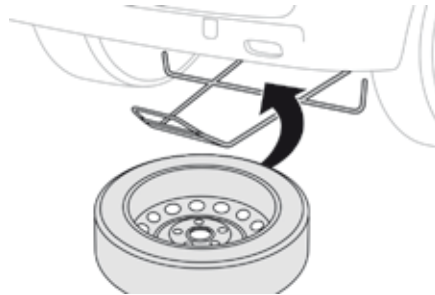

- ☞ Position the wheel facing the carrier.
- ☞ Progressively return the wheel to the basket by pushing alternately at left and right until it is clear of the hook fixing area.
- ☞ Engage the carrier on the hook, then tighten the bolt using the wheelbrace until the basket is fully home.

Removing a wheel

i Parking the vehicle

Immobilise the vehicle where it does not block traffic: the ground must be level, stable and not slippery.

If your vehicle has a manual gearbox, engage first gear then switch off the ignition to block the wheels.

If your vehicle has an automatic gearbox, place the gear selector at position **P** then switch off the ignition to block the wheels.

If your vehicle has an electronic gearbox, place the gear selector at position **A** then switch off the ignition to block the wheels.

Apply the parking brake and check that the warning lamp is on in the instrument panel.

The occupants must get out of the vehicle and wait where they are safe. Never go underneath a vehicle raised using a jack; use an axle stand.

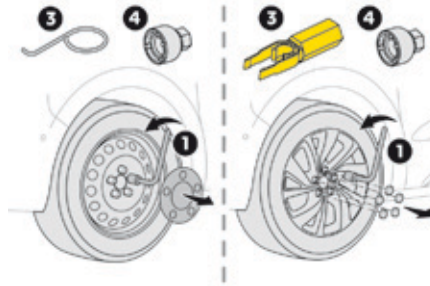

- ☞ If your vehicle has steel wheels, remove the wheel trim using tool **3**.
- ☞ If your vehicle has alloy wheels, remove the cap from each wheel bolt using tool **3**.
- ☞ If your vehicle has security wheel bolts, fit the security bolt socket **4** to the wheelbrace **1** to slacken the security bolt.
- ☞ **Slacken** (without removing) the other wheel bolts using just the wheelbrace **1**.

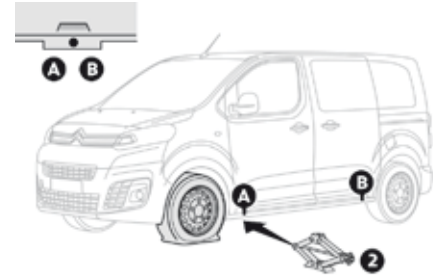

- ☞ Position the foot of the jack on the ground, ensuring that it is directly below the vehicle's jacking point **A** or **B**, the one closest to the wheel to be changed.

- !** Do not use:
- the jack for any other purpose than lifting the vehicle,
 - a jack other than the one supplied by the manufacturer.

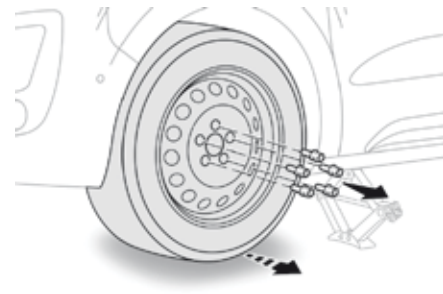
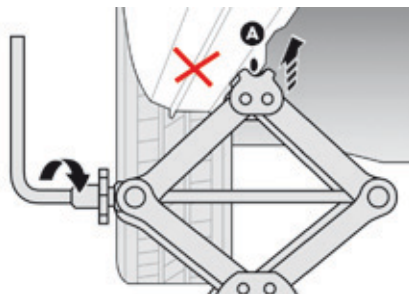
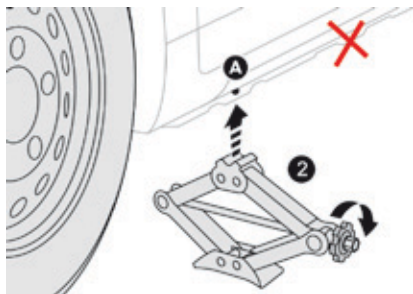

- ☞ Extend the jack **2**, using the hand wheel, until its head comes into contact with the jacking point **A** or **B** used, with the contact surface **A** or **B** on the vehicle correctly engaged with the central part of the head of the jack.
- ☞ Raise the vehicle using the wheelbrace **1**, until there is sufficient space between the wheel and the ground to admit the spare (not punctured) wheel easily.

- ☞ Remove the bolts and store them in a clean place.
- ☞ Remove the wheel.

! Ensure that the jack is stable. If the ground is slippery or loose, the jack may slip or drop - Risk of injury!
Ensure that the jack is positioned only at one of the jacking points **A** or **B** under the vehicle, making sure that the vehicle's contact surface is centred on the head of the jack. Otherwise there is a risk of damage to the vehicle and/or of the jack dropping - Risk of injury!

Fitting a wheel

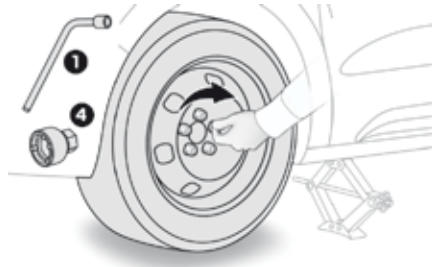

- ☞ Put the wheel in place on the hub.
- ☞ Screw in the bolts fully by hand.
- ☞ If your vehicle is so equipped, **pre-tighten** the security bolt using the wheelbrace **1** fitted with the security socket **4**.
- ☞ **Pre-tighten** the other bolts using the wheelbrace **1** only.

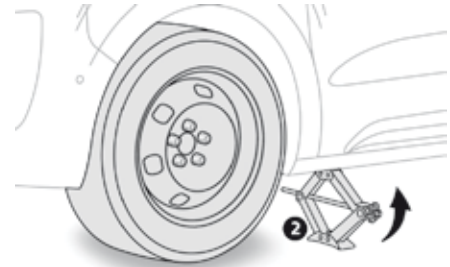

- ☞ Lower the vehicle fully.
- ☞ Fold the jack **2** and detach it.

In the event of a breakdown

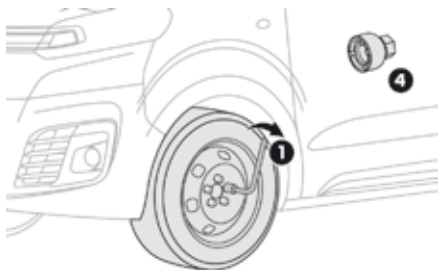

- ☞ If your vehicle is so equipped, tighten the security bolt using the wheelbrace **1** fitted with the security socket **4**.
- ☞ **Tighten** the other bolts using the wheelbrace **1** only.
- ☞ Stow the tools in the tool box.

i Tyre under-inflation detection

The steel spare wheel does not have a sensor.

i After changing a wheel

Stow the punctured wheel in the carrier. Have the tightening of the bolts and the pressure of the spare wheel checked by a CITROËN dealer or a qualified workshop without delay. Have the punctured wheel repaired and refitted to the vehicle as soon as possible.

i If your vehicle has tyre under-inflation detection, check the tyre pressures and reinitialise the system.

i For more information on **Under-inflation detection**, refer to the corresponding section.

i Wheel with wheel trim

When refitting the wheel, refit the wheel trim by placing its cut-out at the valve, and press round its edge with the palm of your hand.

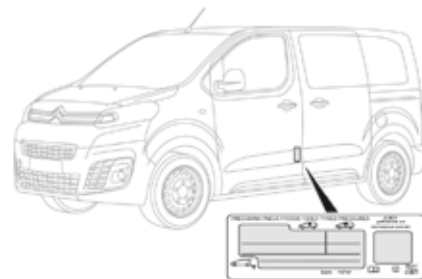

The tyre inflation pressures are given on this label.

Changing a bulb

Types of bulb

Various types of bulb are fitted to your vehicle.
To remove them:

Type A



All glass bulb: pull gently as it is fitted by pressure.

Type B



Bayonet bulb: press on the bulb then turn it anticlockwise.

Type C



Halogen bulb: release the retaining spring from its housing.

Type D



Halogen bulb: turn the bulb anti-clockwise.



Halogen bulbs must be changed after the headlamp has been off for several minutes (risk of serious burns). Do not touch the bulb directly with your fingers, use lint-free cloths.

Type E



Xenon bulb: xenon bulbs must be changed by a CITROËN dealer or a qualified workshop as there is a risk of electrocution.



When each operation has been completed, check the operation of the lighting.

Front lamps

Halogen headlamps

For more information on **Changing a bulb** and in particular the types of bulb, refer to the corresponding section.

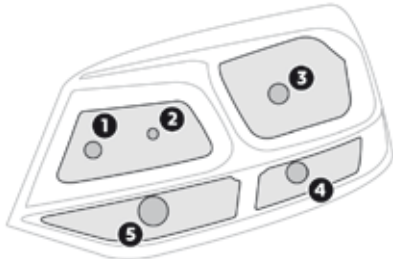

1. Sidelamps.
Type A, W5W-5W.
2. Main beam headlamps.
Type C, H1-55W
3. Dipped beam headlamps.
Type C, H7-55W
4. Daytime running lamps.
Type A, W21W LL-21W
5. Direction indicators.
Type B, PY21W-21W (amber)

i For H7 type bulbs with lugs... take care to observe their correct installation so as to ensure the best lighting performance.

Xenon headlamps

For more information on **Changing a bulb** and in particular the types of bulb, refer to the corresponding section.

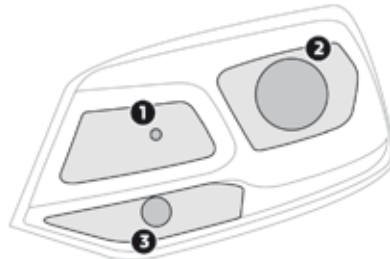

1. Main beam headlamps.
Type C, H1-55W.
2. Dipped beam headlamps.
Type E, D8S 25W
3. Direction indicators.
Type B, PY21W-21W (amber)

Front fog lamps

Type D, H11-55W

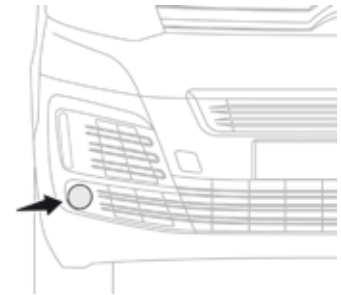

i In some weather conditions (e.g. low temperature or humidity), the presence of misting on the internal surface of the glass of the headlamps and rear lamps is normal; it disappears after the lamps have been on for a few minutes.

Daytime running lamps / sidelamps

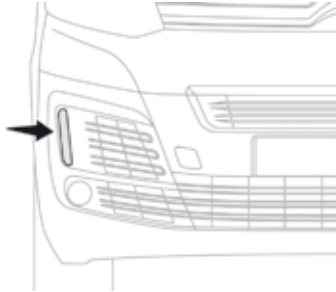

If fitted to your vehicle, contact a CITROËN dealer or a qualified workshop for the replacement of this type of LED lamp and light guide.
A replacement kit for the LEDs is available from CITROËN dealers.

Direction indicator side repeater

Type A, WY5W-5W (amber)

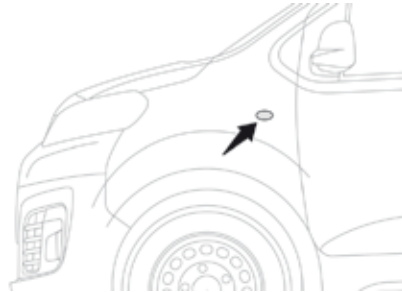

- Push the repeater towards the rear and disengage it.
- When refitting, engage the repeater towards the front and then bring it towards the rear.

Amber coloured bulbs (direction indicators and side repeaters) must be replaced with bulbs of identical specification and colour.



The headlamps have polycarbonate lenses with a protective coating:

- ☞ **do not clean them using a dry or abrasive cloth, nor with a detergent or solvent product,**
- ☞ use a sponge and soapy water or a pH neutral product,
- ☞ when using a high pressure washer on persistent marks, do not keep the lance directed towards the lamps or their edges for too long, so as not to damage their protective coating and seals.

Changing a bulb should only be done after the headlamp has been switched off for several minutes (risk of serious burns).

- ☞ Do not touch the bulb directly with your fingers, use a lint-free cloth.

It is imperative to use only anti-ultraviolet (UV) type bulbs to avoid damaging the headlamp.

Always replace a failed bulb with a new bulb with the same type and specification.

Dipped beam headlamps (halogen headlamps)

Type C, H7-55W

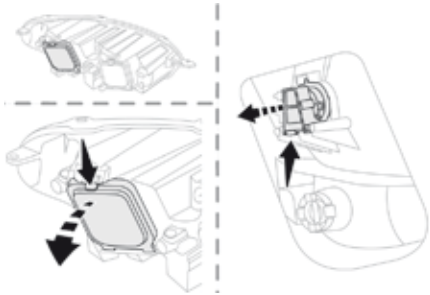

- ☞ Press the upper clip on the cover then tip it rearwards to remove it.
- ☞ Press the lower clip on the electrical connector and remove the assembly of connector and bulb.
- ☞ Pull the bulb out and change it.

To refit, carry out these operations in reverse order.

Daytime running lamps (halogen headlamps)

Type A, W21W LL-21W

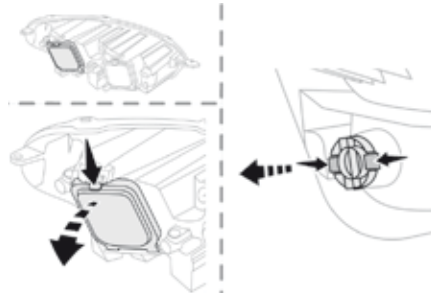

- ☞ Press the upper clip on the cover then tip it rearwards to remove it.
- ☞ Press the two side clips on the electrical connector and remove the assembly of connector and bulb.
- ☞ Pull out the bulb and change it.

To refit, carry out these operations in reverse order.

Sidelamps (halogen headlamps)

Type A, W5W

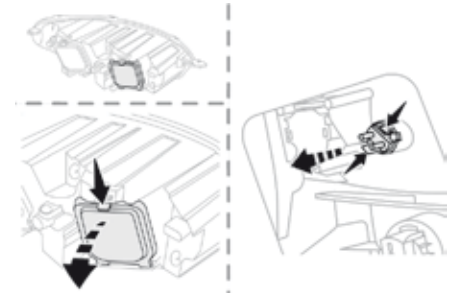

- ☞ Press the upper clip on the cover then tip it rearwards to remove it.
- ☞ Press the two side clips on the electrical connector and remove the assembly of connector and bulb.
- ☞ Pull the bulb out and change it.

To refit, carry out these operations in reverse order.

i When refitting the connector and bulb in the lamp, push the assembly into its housing until it clicks into place.

Main beam headlamps (halogen headlamps)

Type C, H1-55W

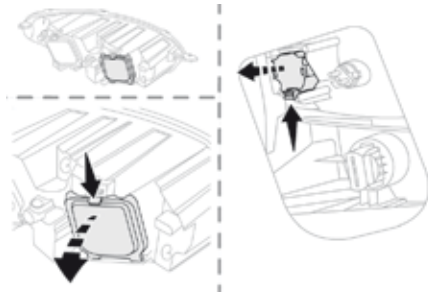

- ☞ Press the upper clip on the cover then tip it rearwards to remove it.
- ☞ Press the lower clip on the electrical connector and remove the assembly of connector and bulb.
- ☞ Pull the bulb out and change it.

To refit, carry out these operations in reverse order.



Be aware that the area behind the right-hand headlamp (facing forwards) may be hot, with the risk of burns (overflow pipe).

Direction indicators (halogen headlamps)

Type B, PY21W-21W (amber)

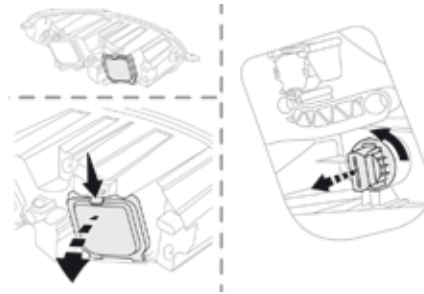

- ☞ Press the upper clip on the cover then tip it rearwards to remove it.
- ☞ Turn the bulb holder a quarter turn anti-clockwise.
- ☞ Remove the bulb holder.
- ☞ Change the failed bulb.

To refit, carry out these operations in reverse order.



Faster flashing of a direction indicator warning lamp (left or right) indicates a failed bulb on that side.

Dipped beam headlamps (xenon headlamps)

Type E, D8S 25W

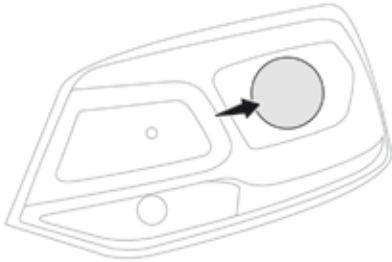

i Replacement of D8S xenon bulbs must be done by a CITROËN dealer or a qualified workshop as there is a risk of electrocution.

It is recommended that both D8S bulbs be replaced at the same time, in the event of the failure of one of them.

Main beam headlamps (xenon headlamps)

Type C, H1-55W

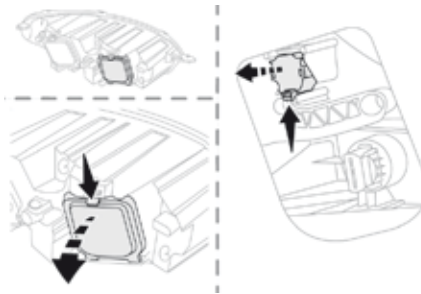

- ☞ Press the upper clip on the cover then tip it rearwards to remove it.
- ☞ Press the lower clip on the electrical connector and remove the assembly of connector and bulb.
- ☞ Pull the bulb out and change it.

To refit, carry out these operations in reverse order.

i When refitting the connector and bulb in the lamp, push the assembly into its housing until it clicks into place.

Direction indicators (xenon headlamps)

Type B, PY21W-21W (amber)

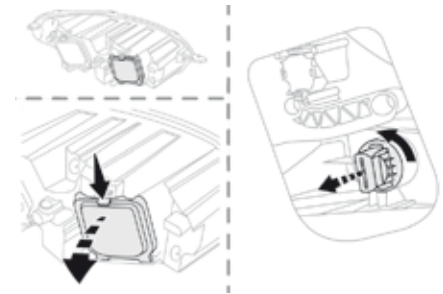

- ☞ Press the upper clip on the cover then tip it rearwards to remove it.
- ☞ Turn the bulb holder a quarter turn anti-clockwise.
- ☞ Change the failed bulb.

To refit, carry out these operations in reverse order.

i Faster flashing of a direction indicator warning lamp (left or right) indicates a failed bulb on that side.

Front foglamps

Type C, H11-55W

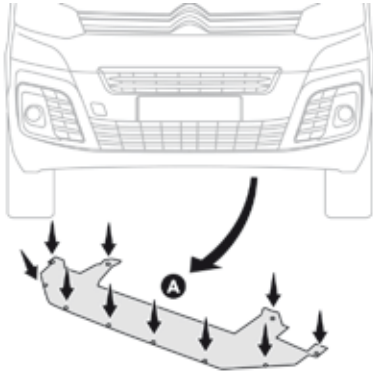

- ☞ Below the front bumper, unscrew the fixing screws for the deflector A.
- ☞ Remove the deflector A.

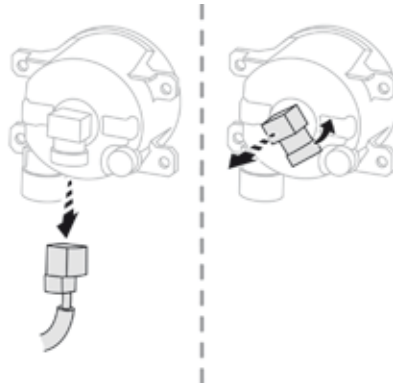

- ☞ Press the locking clip and disconnect the connector.
- ☞ Turn the bulb holder a quarter turn anti-clockwise.
- ☞ Remove the bulb holder.
- ☞ Change the failed bulb.

To refit, carry out these operations in reverse order.

i You can also go to a CITROËN dealer or a qualified workshop for the replacement of these bulbs.

Rear lamps (side-hinged rear doors)

For more information on **Changing a bulb** and in particular, the types of bulbs, refer to the corresponding section.



1. Brake lamps / sidelamps.
Type B, P21/5W-21/5W
2. Direction indicators.
Type B, PY21W-21W (amber)
3. Reversing lamps.
Type B, P21W-21W
4. Foglamps / sidelamps.
Type B, P21/4W-21/4W

i For vehicles with interior trim, contact a CITROËN dealer or a qualified workshop to have the work done.

- ☞ Identify the failed bulb then open the rear doors.

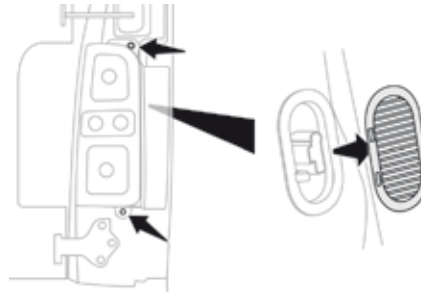

- ☞ From inside, remove the ventilation grille, if your vehicle has one.
- ☞ From outside, unscrew the two lamp fixing screws.

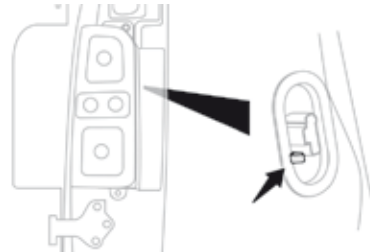

- ☞ While holding the lamp in place, press the clip on the inside then carefully remove the lamp.
- ☞ Disconnect the electrical connector.

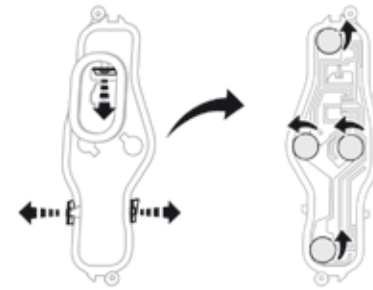

- ☞ Spread the three lugs slightly, then extract the bulb holder.
 - ☞ Remove the failed bulb by pressing lightly on it, then turning it a quarter turn clockwise.
 - ☞ Change the bulb.
- To reassemble, carry out these operations in reverse order.

Third brake lamp (side-hinged doors)

Type A, W5W-5W



- ☞ Open the left hand rear door.

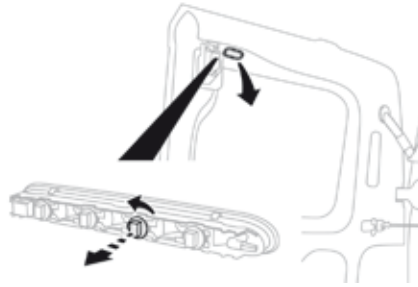

- ☞ Remove the plastic cover using a small screwdriver.
- ☞ Using a screwdriver through the aperture, push the lamp towards the outside.
- ☞ Disconnect the electrical connector.
- ☞ Remove the lamp.
- ☞ Turn the bulb holder a quarter turn anti-clockwise.
- ☞ Change the failed bulb.

To refit, press on the lamp to clip it in place.

Number plate lamps (side-hinged doors)

Type A, W5W-5W

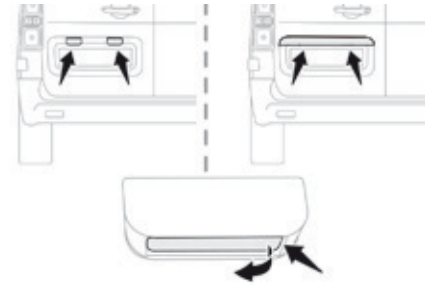

- ☞ Insert a thin screwdriver into one of the cut-outs in the lens.
- ☞ Push it outwards to unclip it.
- ☞ Remove the lens.
- ☞ Change the failed bulb.

To refit, press on the lens to clip it in place.

In the event of a breakdown

Courtesy lamps (front and rear)

Type A, W5W-5W

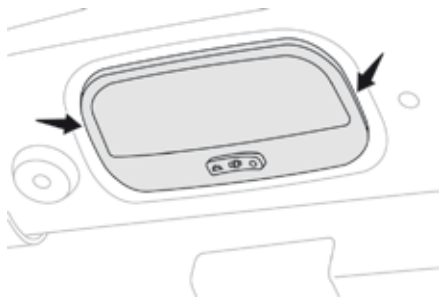

- ⑧ Unclip the lens by inserting a thin screwdriver into the cut-outs at each side of the lamp.
- ⑧ Pull the bulb out and change it.
- ⑧ Clip the lens in place and ensure that it is secure.

Rear lamps (tailgate)

For more information on **Changing a bulb** and in particular, the types of bulbs, refer to the corresponding section.



1. Brake lamps / sidelamps.
Type B, P21/5W-21/5W
2. Direction indicators.
Type B, PY21W-21W (amber)
3. Reversing lamps.
Type B, P21W-21W
4. Foglamps / sidelamps.
Type B, P21/4W-21/4W

i For vehicles with interior trim, contact a CITROËN dealer or a qualified workshop to have the work done.

- ☞ Identify the failed bulb then open the boot.

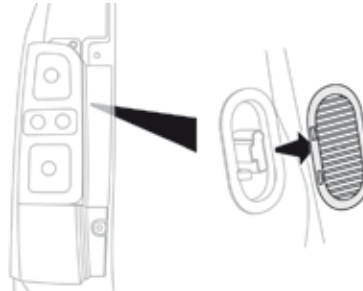

- ☞ From inside, remove the cover, if your vehicle has one.

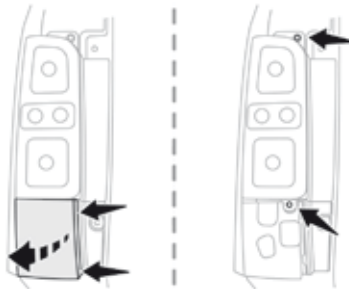

- ☞ From the outside, press on the inner clips on the plastic finisher then tip it towards the outside to remove it.
- ☞ Unscrew the two lamp fixing screws.

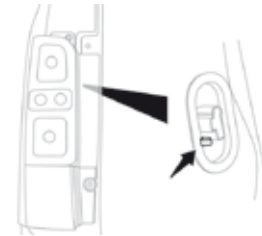

- ☞ While holding the lamp in place, press the clip on the inside then carefully remove the lamp.
- ☞ Disconnect the electrical connector.

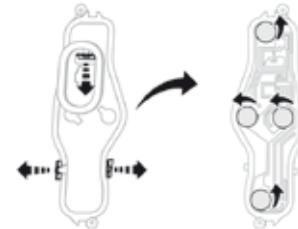

- ☞ Spread the three lugs slightly, then extract the bulb holder.
- ☞ Remove the failed bulb by pressing lightly on it, then turning it a quarter turn clockwise.
- ☞ Change the bulb.

To reassemble, carry out these operations in reverse order.

Third brake lamp (tailgate)

Type A, W5W-5W



- ☞ Open the tailgate.

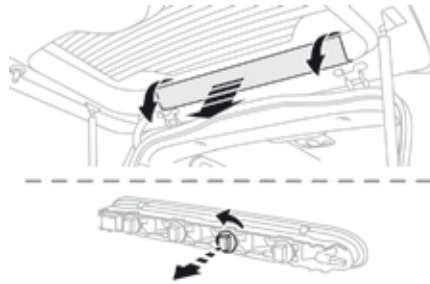

- ☞ Unclip the trim at each end by turning it upwards.
- ☞ Pull on the trim to disengage the central clips, then remove it.
- ☞ Using a screwdriver through the aperture, push the lamp towards the outside.
- ☞ Disconnect the electrical connector.
- ☞ Remove the lamp.
- ☞ Turn the bulb holder a quarter turn anti-clockwise.
- ☞ Change the failed bulb.

To refit, carry out these operations in reverse order.

To refit the lamp and trim, press on them to clip them in place.

Number plate lamps (tailgate)

Type A, W5W-5W

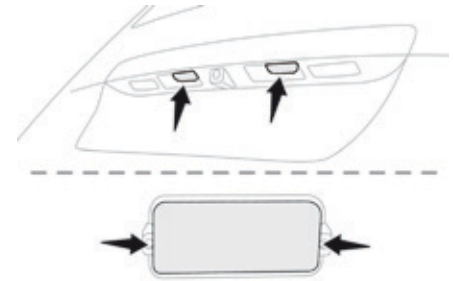

- ☞ Insert a thin screwdriver into one of the cut-outs in the lens.
- ☞ Push it outwards to unclip it.
- ☞ Remove the lens.
- ☞ Change the failed bulb.

To refit, press on the lens to clip it in place.

Courtesy lamps (front and rear)



For the replacement of this type of LED lamp and light guide, contact a CITROËN dealer or a qualified workshop.
A replacement kit for the LEDs is available from CITROËN dealers.

Platform cab



Rear lamps

For more information on **Changing a bulb** and in particular, the types of bulbs, refer to the corresponding section.

1. Direction indicators.
Type B, P21W-21W
2. Brake lamps.
Type B, P21W-21W
3. Sidelamps.
Type B, R10W-10W
4. Reversing lamps.
Type B, P21W-21W
5. Foglamps.
Type B, P21W-21W



- 🔧 Identify the failed bulb.
- 🔧 Remove the four screws securing the lens.
- 🔧 Pull the lens towards you.
- 🔧 Remove the failed bulb by pressing lightly on it and then turning it a quarter turn clockwise.
- 🔧 Change the bulb.

To reassemble, carry out these operations in reverse order.

Changing a fuse

Access to the tools

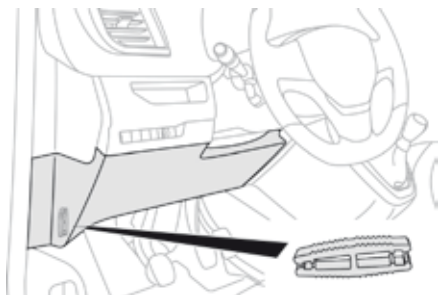

The extraction tweezers is located behind the fusebox cover, on the dashboard pillar.

- ☞ Unclip the cover by pulling at the top left, then right.
- ☞ Disengage the cover completely and turn it over,
- ☞ Take the tweezers from its housing.

Changing a fuse

Before changing a fuse:

- ☞ the cause of the failure must be identified and rectified,
- ☞ all electrical consumers must be switched off,
- ☞ the vehicle must be immobilised with the ignition off,
- ☞ identify the failed fuse using the tables and layout drawings in the following pages.

To replace a fuse, you must:

- ☞ use the special tweezers to extract the fuse from its housing and check the condition of its filament.
- ☞ always replace the failed fuse with a fuse of the same rating (same colour); using a different rating could cause faults (risk of fire).

If the fuse fails again soon after replacement, have the vehicle's electrical system checked by a CITROËN dealer or a qualified workshop.

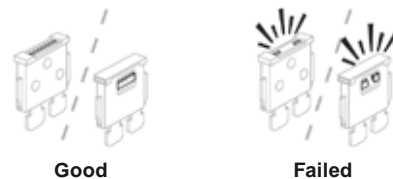

Good

Failed



Tweezer

! The replacement of a fuse not shown in the tables below may cause a serious malfunction of your vehicle. Contact a CITROËN dealer or a qualified workshop.

i Installing electrical accessories

Your vehicle's electrical system is designed to operate with standard or optional equipment.

Before installing other electrical equipment or accessories on your vehicle, contact a CITROËN dealer or a qualified workshop.

! CITROËN will not accept responsibility for the cost incurred in repairing your vehicle or for rectifying malfunctions resulting from the installation of accessories not supplied and not recommended by CITROËN and not installed in accordance with its instructions, in particular when the combined consumption of all of the additional equipment connected exceeds 10 milliamperes.

i For more information on installing a towbar or equipment of the TAXI type, contact a CITROËN dealer.

Dashboard fuses

The fusebox is placed in the lower dashboard (left-hand side).

Access to the fuses



☞ Unclip the cover by pulling at top left, then right.

Version 1 (Eco)

The fuses described hereafter vary according to the equipment in your vehicle.

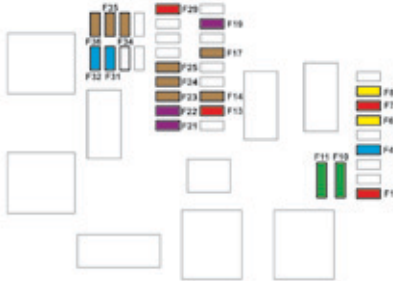

| Fuse N° | Rating (A) | Functions |
|---------|------------|---|
| F1 | 10 | Electric power steering, clutch switch |
| F4 | 15 | Horn. |
| F5 | 20 | Front/rear screenwash pump. |
| F6 | 20 | Front/rear screenwash pump. |
| F7 | 10 | Rear 12 V accessory socket. |
| F8 | 20 | Single or double rear wipers. |
| F10/F11 | 30 | Front and rear, exterior, interior locks. |
| F13 | 10 | Front air conditioning controls, radio controls, gear lever, head-up display. |
| F14 | 5 | Alarm, emergency and assistance calls. |
| F17 | 5 | Instrument panel. |
| F19 | 3 | Steering mounted controls. |
| F21 | 3 | "Keyless Entry and Starting" system or ignition switch. |
| F22 | 3 | Rain and sunshine sensor, multifunction detection camera. |
| F23 | 5 | Seat belt unfastened or not fastened display screen. |
| F24 | 5 | Touch screen, reversing camera and parking sensors. |
| F25 | 5 | Airbags. |
| F29 | 20 | Audio system, touch screen, CD player, navigation. |
| F31 | 15 | Audio system (battery +). |
| F32 | 15 | Front 12 V accessory socket. |
| F34 | 5 | Blind spot monitoring system, door mirror electric controls. |
| F35 | 5 | Heated washer jets, headlamp beam height control. |
| F36 | 5 | Torch charger, rear courtesy lamp. |

Version 2 (Full)

The fuses described hereafter vary according to the equipment in your vehicle.

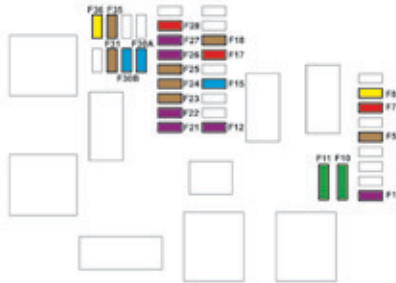

| Fuse N° | Rating (A) | Functions |
|-----------|------------|---|
| F1 | 3 | "Keyless Entry and Starting" system or ignition switch. |
| F5 | 5 | Touch screen, reversing camera and parking sensors. |
| F7 | 10 | Rear air conditioning controls, Hi-Fi amplifier. |
| F8 | 20 | Single or double rear wiper. |
| F10/F11 | 30 | Front and rear, exterior, interior locks. |
| F12 | 3 | Alarm. |
| F17 | 10 | Rear 12 V accessory socket. |
| F18 | 5 | Emergency and assistance calls. |
| F21 | 3 | Torch charger, rear courtesy lamp. |
| F22 | 3 | Glove box lamp, rear courtesy lamps. |
| F23 | 5 | Blind spot monitoring system, door mirror electric controls. |
| F24 | 5 | Steering mounted controls. |
| F25 | 5 | Headlamp beam height control. |
| F26 | 3 | Seat belt unfastened or not fastened display screen. |
| F27 | 3 | Rain and sunshine sensor, multifunction detection camera. |
| F28 | 10 | Front air conditioning controls, radio controls, gear lever, head-up display. |
| F30A or B | 15 | Audio system (battery +). |
| F31 | 5 | Airbags. |
| F33 | 15 | Front 12 V accessory socket. |
| F35 | 5 | Instrument panel. |
| F36 | 20 | Audio system, touch screen, CD player, navigation. |

Engine compartment fuses

The fusebox is located in the engine compartment near the battery.

Access to the fuses

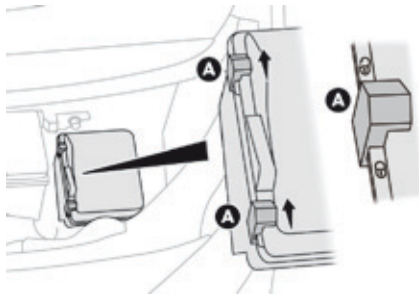

- 🔧 Release the two latches **A**.
- 🔧 Remove the cover.
- 🔧 Change the fuse.
- 🔧 When you have finished, close the cover carefully then engage the two latches **A**, to ensure correct sealing of the fusebox.

The fuses described hereafter vary according to the equipment in your vehicle.

| Fuse N° | Rating (A) | Functions |
|---------|------------|---|
| F12 | 5 | Heated washer jets. |
| F14 | 25 | Front and rear screenwash pump. |
| F15 | 5 | Front radar and emergency braking, electric power steering. |
| F17 | 10 | Built-in systems interface. |
| F19 | 30 | Front wiper motor. |
| F20 | 15 | Front and rear screenwash pump. |
| F21 | 20 | Headlamp wash pump. |
| F22 | 15 | Horn. |
| F23 | 15 | Right hand main beam headlamp. |
| F24 | 15 | Left hand main beam headlamp. |

12 V battery

Procedure for starting the engine using another battery or charging a discharged battery.

General points

Lead-acid starter batteries

 Batteries contain harmful substances such as sulphuric acid and lead. They must be disposed of in accordance with regulations and must not, in any circumstances, be discarded with household waste. Take used remote control batteries and vehicle batteries to a special collection point.

 Versions equipped with Stop & Start are fitted with a 12 V lead-acid battery of specific technology and specification. Its replacement should be carried out only by a CITROËN dealer or a qualified workshop.

 Protect your eyes and face before handling the battery. All operations on the battery must be carried out in a well ventilated area and away from naked flames and sources of sparks, so as to avoid the risk of explosion or fire. Wash your hands afterwards.

 If your vehicle has an automatic gearbox, do not try to start the engine by pushing the vehicle.

Access to the battery

The battery is located under the bonnet.

- ☞ Open the bonnet using the interior release lever, then the exterior safety catch.
- ☞ Secure the bonnet stay.

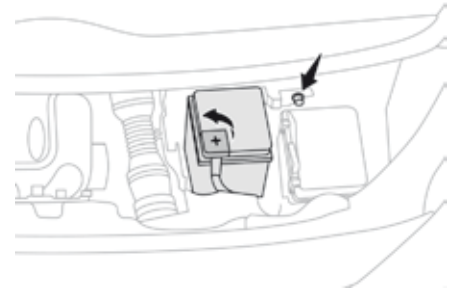

- ☞ If fitted to your vehicle, remove the plastic cover to access the (+) terminal. The battery (-) terminal is not accessible. A remote earth point is provided at the front of the vehicle.

 For more information on the **Bonnet** and **Engine**, refer to the corresponding section(s).

Starting using another battery

When your vehicle's battery is discharged, the engine can be started using a slave battery (external or on another vehicle) and jump lead cables or a battery booster.

- !** Never try to start the engine by connecting a battery charger. Never use a 24 V or higher battery booster.
- First check that the slave battery has a nominal voltage of 12 V and a capacity at least equal to that of the discharged battery.
- The two vehicles must not be in contact with each other.
- Switch off the electrical consumers on both vehicles (audio system, wipers, lighting, ...).
- Ensure that the jump lead cables do not pass close to moving parts of the engine (cooling fan, belts, ...).
- Do not disconnect the (+) terminal when the engine is running.

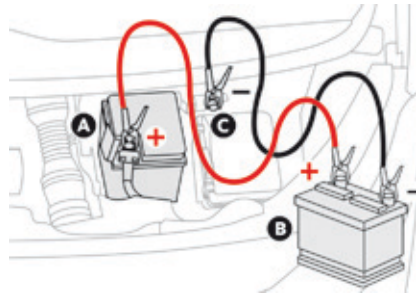

- ☞ Raise the plastic cover on the (+) terminal, if your vehicle has one.
- ☞ Connect the red cable to the positive terminal (+) of the flat battery **A** (at the metal elbow) then to the positive terminal (+) of the slave battery **B** or the booster.
- ☞ Connect one end of the green or black cable to the negative terminal (-) of the slave battery **B** or the booster (or earth point on the other vehicle).
- ☞ Connect the other end of the green or black cable to the earth point **C** on the broken down vehicle.
- ☞ Start the engine of the vehicle with the good battery and leave it running for a few minutes.
- ☞ Operate the starter on the broken down vehicle and let the engine run.

If the engine does not start straight away, switch off the ignition and wait a few moments before trying again.

- ☞ Wait until the engine returns to idle then disconnect the jump lead cables in the reverse order.
- ☞ Refit the plastic cover to the (+) terminal, if your vehicle has one.
- ☞ Allow the engine to run for at least 30 minutes, by driving or with the vehicle stationary, so that the battery reaches an adequate state of charge.

i Some functions, including Stop & Start, are not available if the battery is not sufficiently charged.

Charging the battery using a battery charger

For optimum service life of the battery, it is essential to maintain an adequate state of charge.

In some circumstances it may be necessary to charge the battery:

- if you use your vehicle essentially for short journeys,
- if the vehicle is to be taken off the road for several weeks.

Contact a CITROËN dealer or a qualified workshop.

! If you envisage charging your vehicle's battery yourself, use only a charger compatible with lead-acid batteries of a nominal voltage of 12 V.



If this label is present, it is essential to use only a 12 V charger, to avoid causing irreversible damage to the electrical components related to the Stop & Start system.

! Follow the instructions for use provided by the manufacturer of the charger. Never reverse polarities.

i It is not necessary to disconnect the battery.

- ☞ Switch off the ignition.
- ☞ Switch off all electrical consumers (audio system, lighting, wipers, ...).

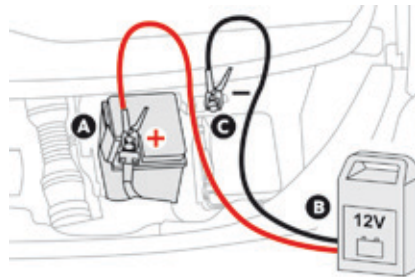

- ☞ Switch off the charger **B** before connecting the cables to the battery, so as to avoid any dangerous sparks.
- ☞ Ensure that the charger cables are in good condition.
- ☞ Raise the plastic cover, if your vehicle has one, on the (+) terminal.

- ☞ Connect the charger **B** cables as follows:
 - the positive (+) red cable to the (+) terminal of the battery **A**,
 - the negative (-) black cable to the earth point **C** on the vehicle.
- ☞ At the end of the charging operation, switch off the charger **B** before disconnecting the cables from the battery **A**.

! Never try to charge a frozen battery. If the battery has been frozen, have it checked by a CITROËN dealer or a qualified workshop, who will check that the internal components have not been damaged and the casing is not cracked, which could cause a leak of toxic and corrosive acid.

Disconnecting the battery

In order to maintain an adequate state of charge for starting the engine, it is recommended that the battery be disconnected if the vehicle is taken out of service for a long period.

Wait 2 minutes after switching off the ignition before disconnecting the battery.

- ☞ close the windows and the doors before disconnecting the battery,
- ☞ switch off all electrical consumers (audio system, wipers, lighting, ...),
- ☞ switch off the ignition and wait for four minutes.

Having exposed the battery, it is only necessary to disconnect the (+) terminal.

Quick release terminal

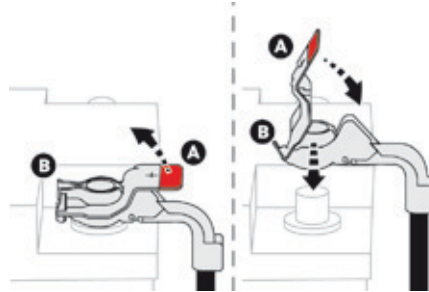

Disconnecting the (+) terminal

- ☞ Raise the lever **A** fully to release the clamp **B**.

Reconnecting the (+) terminal

- ☞ Position the open clamp **B** of the cable on the positive post (+) of the battery.
- ☞ Press down on the clamp to position it correctly on the battery post.
- ☞ Lock the clamp by lowering the lever **A**.

! Do not force the lever as locking will not be possible if the clamp is not positioned correctly; start the procedure again.

Following reconnection of the battery

After reconnecting the battery, switch on the ignition and wait 1 minute before starting to allow initialisation of the electronic systems. However, if minor problems persist following this operation, contact a CITROËN dealer or a qualified workshop.

Referring to the corresponding section, you must yourself reinitialise or reset certain systems, such as:

- the remote control or electronic key (depending on version),
- the electric windows,
- the date and time,
- the radio preset stations.

i The Stop & Start system may not be operational during the trip following the first engine start.

In this case, the system will only be available again after a continuous period of immobilisation of the vehicle, a period which depends on the ambient temperature and the state of charge of the battery (up to about 8 hours).

Battery capacity

| Vehicle length | Rating in Ah (Ampere hours) |
|----------------|--------------------------------|
| Compact (L1) | 480 |
| Standard (L2) | 640 |
| Long (L3) | 720 / 800 |

! Always replace the battery by one of equivalent specification.

Towing

Procedure for having your vehicle towed or for towing another vehicle using a removable towing eye.

Access to the tools

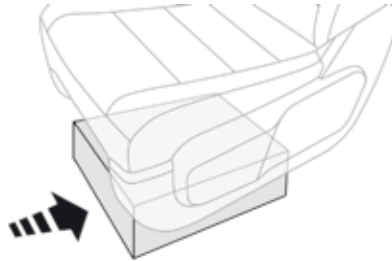

The towing eye is stowed in the tool box.

i For more information on the **Tool box**, refer to the corresponding section.

! If your vehicle is fitted with a manual gearbox, put the gear lever into neutral.

If your vehicle has an automatic or electronic gearbox, place the gear selector at position **N**.

The failure to observe this special point may lead to damage to components of the braking system and the lack of braking assistance on restarting the engine.

Towing your vehicle

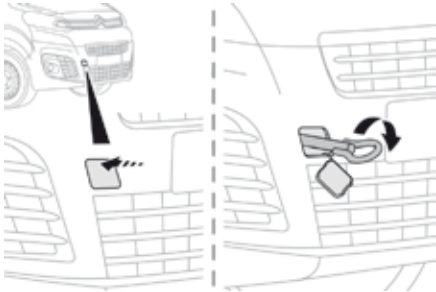

- ☞ On the front bumper, press the cover (as shown above) to unclip it.
- ☞ Screw the towing eye in fully.
- ☞ Install the towing arm.
- ☞ Switch on the hazard warning lamps on the towed vehicle.
- ☞ Move off gently and drive slowly over a short distance only.

Towing another vehicle

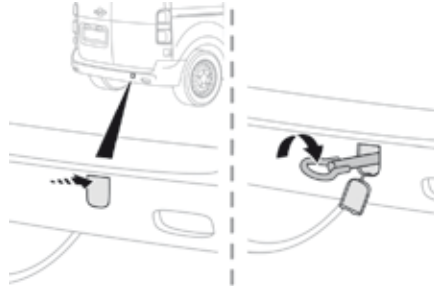

- ☞ On the rear bumper, press the cover (as shown above) to unclip it.
- ☞ Screw the towing eye in fully.
- ☞ Install the towing arm.
- ☞ Switch on the hazard warning lamps on the towed vehicle.
- ☞ Move off gently and drive slowly over a short distance only.

! General recommendations

Observe the legislation in force in your country.

Ensure that the weight of the towing vehicle is higher than that of the towed vehicle.

The driver must remain at the wheel of the towed vehicle and must have a valid driving licence.

When towing a vehicle with all four wheels on the ground, always use an approved towing arm; rope and straps are prohibited.

The towing vehicle must move off gently. When towing a vehicle with the engine off, there is no longer any power assistance for braking or steering.

In the following cases, you must always call on a professional recovery service:

- vehicle broken down on a motorway or fast road,
- four-wheel drive vehicle,
- when it is not possible to put the gearbox into neutral, unlock the steering, or release the parking brake,
- towing with only two wheels on the ground,
- where there is no approved towing arm available...

Running out of fuel (Diesel)

On vehicles fitted with Diesel engines, the fuel system must be primed if you run out of fuel. For all versions other than BlueHDi, refer to the corresponding engine compartment view.

i For more information on **Diesel misfuel prevention**, refer to the corresponding section.

! If the engine does not start first time, don't keep trying but start the procedure again from the beginning.

1.6 HDi engine (except BlueHDi)



- ☞ Add at least five litres of Diesel fuel to the tank.
- ☞ Open the bonnet.
- ☞ If necessary, unclip the styling cover for access to the priming pump.
- ☞ Squeeze and release the priming pump repeatedly until resistance is felt (there may be resistance at the first press).
- ☞ Operate the starter to start the engine (if the engine does not start at the first attempt, wait around 15 seconds before trying again).
- ☞ If the engine does not start after a few attempts, operate the priming pump again then start the engine.
- ☞ Refit the styling cover and clip it in place.
- ☞ Close the bonnet.

BlueHDi engine

- ☞ Fill the fuel tank with at least five litres of Diesel.
- ☞ Switch on the ignition (without starting the engine).
- ☞ Wait around 6 seconds and switch off the ignition.
- ☞ Repeat the operation 10 times.
- ☞ Operate the starter to run the engine.

Other engines

- ☞ Add at least five litres of Diesel fuel to the tank.
- ☞ Open the bonnet.
- ☞ If necessary, unclip the styling cover for access to the priming pump.
- ☞ Squeeze and release the priming pump repeatedly until resistance is felt (there may be resistance at the first press).
- ☞ Operate the starter to start the engine (if the engine does not start at the first attempt, wait around 15 seconds before trying again).
- ☞ If the engine does not start after a few attempts, operate the priming pump again then start the engine.
- ☞ Refit the styling cover and clip it in place.
- ☞ Close the bonnet.



Dimensions (in mm)

These dimensions have been measured on an unladen vehicle.

Mirrors folded

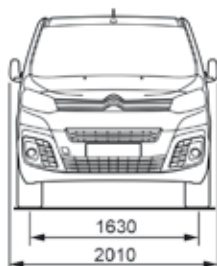

Side-hinged doors

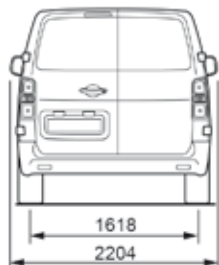

Tailgate



Compact (L1)

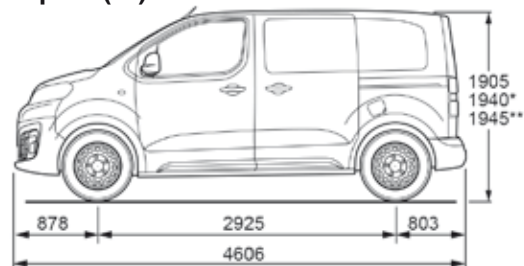

Standard (L2)

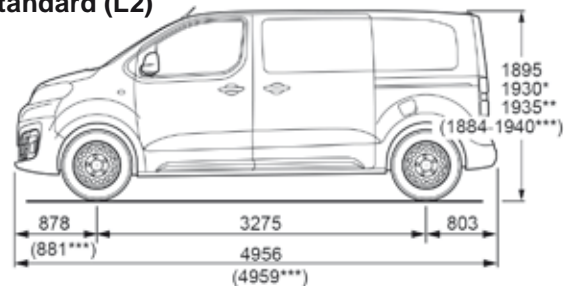

Long (L3)

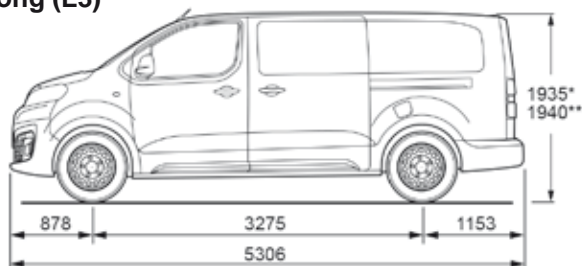

* Increased payload.

** Payload increased with high body.

*** Depending on the country of sale.



Compact (L1)

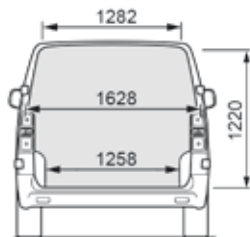
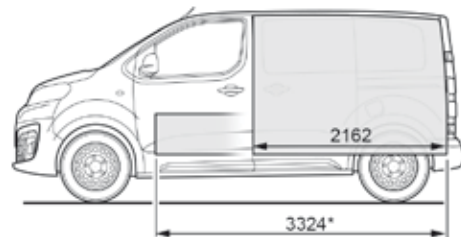
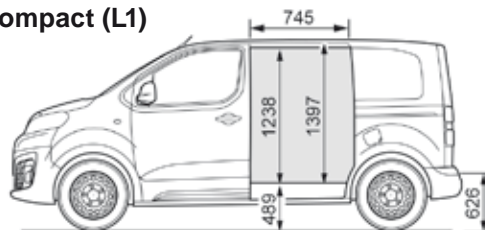

Standard (L2)

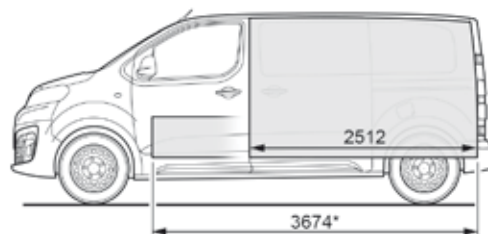
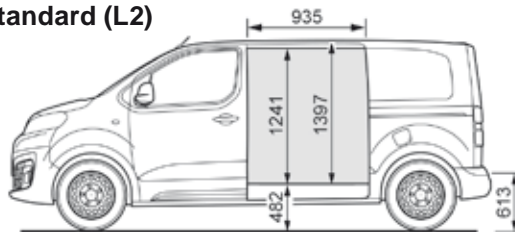

Long (L3)

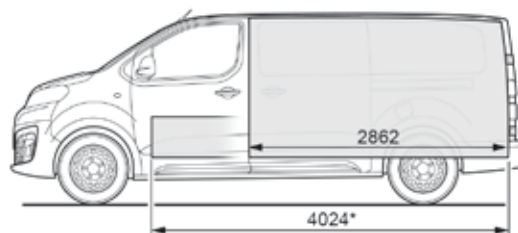
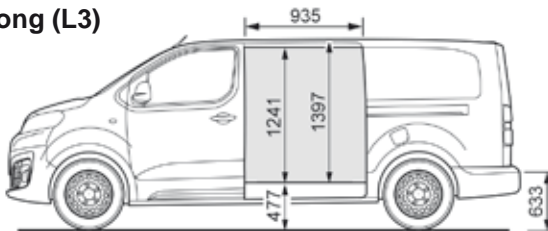

* With moduwork, flap removed.



Mirrors folded

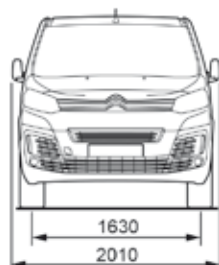

Side-hinged doors

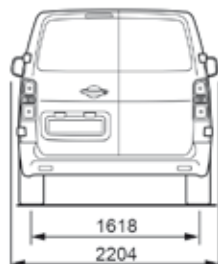

Tailgate



Compact (L1)

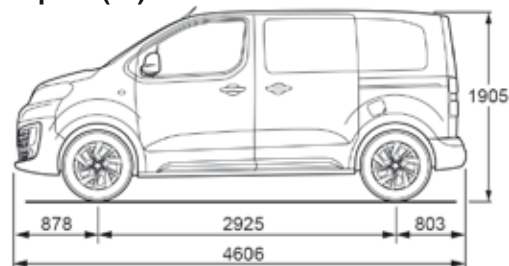

Standard (L2)

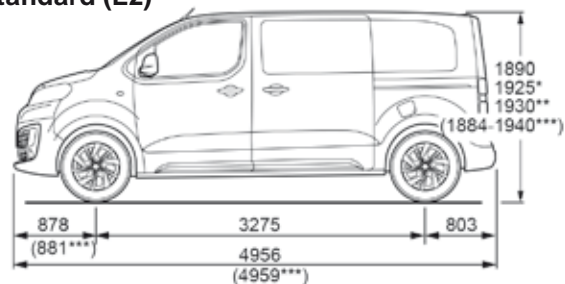

Long (L3)

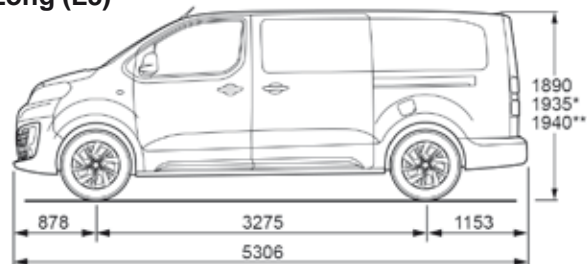

* Increased payload.

** Payload increased with high body.

*** Depending on the country of sale.

Platform cab

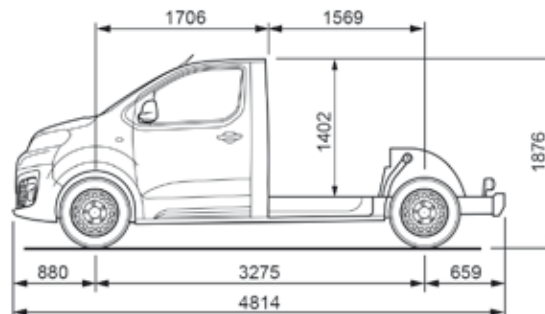
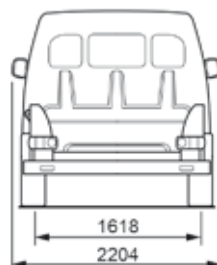
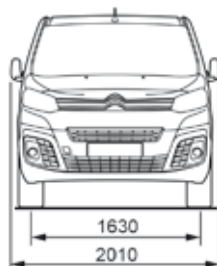

Engines

Engine characteristics

The engine characteristics (capacity, maximum power, maximum power speed, fuel, CO₂ emissions...) for your vehicle are given in the registration document, as well as in sales brochures.

These characteristics correspond to the values type-approved on a test bed, under conditions defined in European legislation (Directive 1999/99/EC).

For more information, contact a CITROËN dealer or a qualified workshop.

Weights

Weights and towed loads

The maximum weights and towed loads for your vehicle are given in the registration document, as well as in sales brochures.

These values are also present on the manufacturer's plate or label.

For more information, contact a CITROËN dealer or a qualified workshop.

The kerb weight is equal to the unladen weight + driver (75 kg).

The GTW and towed load values indicated apply up to a maximum altitude of 1 000 metres; the towed load mentioned must be reduced by 10 % for every additional 1 000 metres.

The weight of the braked trailer can be increased, within the GTW limit, on condition that the GVW of the towing vehicle is reduced by the same amount.

The recommended nose weight is the vertical load on the towbar ball (removable with or without tools).

GVW: gross vehicle weight, the maximum authorised vehicle weight.

GTW: gross train weight, the maximum authorised weight of vehicle plus trailer.

i High ambient temperatures may result in a reduction in the performance of the vehicle to protect the engine; when the ambient temperature is higher than 37 °C, limit the towed weight.

! Towing with a lightly loaded vehicle can adversely affect roadholding. Braking distances are increased when towing a trailer. Never exceed 60 mph (100 km/h) when towing (comply with the legislation in force in your country).

i If the ambient temperature is high, it is recommended that the engine be allowed to idle for 1 to 2 minutes after the vehicle comes to a stop, to facilitate its cooling.



EURO 4 and 5 Diesel engines

| Engine | Engine code | Gearbox | Engine oil capacity with filter replacement (litres) | Length | Unbraked trailer weight (kg) 8-9 seats | Trailer nose weight (kg) 8-9 seats |
|------------------|-------------|--------------------------|--|------------|--|------------------------------------|
| 1.6 litre HDi 90 | 9HF (DV6DU) | Manual (5-speed) | - | L1, L2, L3 | - | - |
| | | | | L2*, L3* | | - |
| 2 litre HDi 150 | AHX (DW10F) | Manual (6-speed) | 6.1 | L1, L2, L3 | | - |
| | | | | L2*, L3* | | - |
| | | EAT6 automatic (6-speed) | | L1, L2, L3 | | - |
| | | | | L2*, L3* | | - |

* Increased payload.



| Engine | Engine code | Gearbox | Engine oil capacity with filter replacement (litres) | Length | Unbraked trailer weight (kg) 8-9 seats | Trailer nose weight (kg) 8-9 seats |
|---------------------|--------------|--------------------------|--|------------|--|------------------------------------|
| 2 litre BlueHDi 150 | AHX (DW10FD) | Manual (6-speed) | 6.1 | L1, L2, L3 | - | - |
| | | | | L2*, L3* | | - |
| | | EAT6 automatic (6-speed) | | L1, L2, L3 | | - |
| | | | | L2*, L3* | | - |

* Increased payload.



EURO 6 Diesel engines

| Engine | Engine code | Gearbox | Engine oil capacity with filter replacement (litres) | Length | Unbraked trailer weight (kg) 8-9 seats | Trailer nose weight (kg) 8-9 seats | | |
|---------------------------|--------------|---------------------------|--|------------|--|------------------------------------|-----|----|
| 1.6 litre BlueHDi 95 | BHV (DV6FDU) | Manual (5-speed) | 5.6 | L1, L2, L3 | 750 | 72 | | |
| | | | | L2*, L3* | | 80 | | |
| 1.6 litre BlueHDi 95 S&S | BHS (DV6FCU) | ETG6 electronic (6-speed) | 5.6 | L1, L2, L3 | | 750 | 72 | |
| | | | | L2*, L3* | | | 80 | |
| 1.6 litre BlueHDi 115 S&S | BHX (DV6FCU) | Manual (6-speed) | 5.6 | L1, L2, L3 | | | 750 | 72 |
| | | | | L2*, L3* | | | | 80 |

* Increased payload.



| Engine | Engine code | Gearbox | Engine oil capacity with filter replacement (litres) | Length | Unbraked trailer weight (kg) 8-9 seats | Trailer nose weight (kg) 8-9 seats |
|-------------------------|--------------|--------------------------|--|------------|--|------------------------------------|
| 2 litre BlueHDi 150 S&S | AHX (DW10FD) | Manual (6-speed) | 6.1 | L1, L2, L3 | 750 | 92 |
| | | | | L2*, L3* | | 100 |
| 2 litre BlueHDi 180 S&S | AHH (DW10FC) | EAT6 automatic (6-speed) | 5.1 | L1, L2, L3 | | 80 |
| | | | | L2*, L3* | | 88 |

* Increased payload.

Identification markings

Various visible markings for the identification of your vehicle.

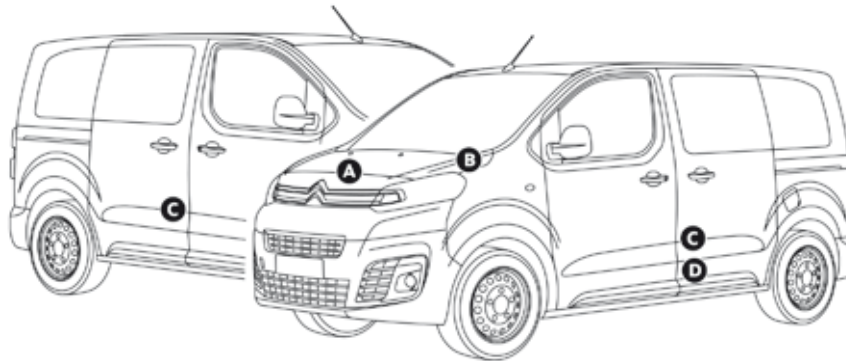

A. Vehicle Identification Number (VIN) under the bonnet.

This number is engraved on the chassis near the right hand front wheel arch.

B. Vehicle Identification Number (VIN) on the windscreen lower cross member.

This number is indicated on a self-adhesive label which is visible through the windscreen.

C. Manufacturer's label.

This self-destroying label on the middle door pillar, right or left hand side, contains the following information:

- the manufacturer's name,
- the European whole vehicle type approval number,
- the vehicle identification number (VIN),
- the maximum authorised weight (gross vehicle weight),
- the maximum authorised weight with trailer (gross train weight),
- the maximum front axle weight,
- the maximum rear axle weight.

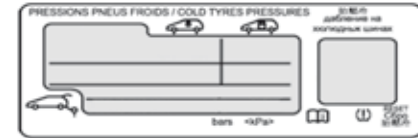

D. Tyre/paint label.

This label on the middle door pillar, driver's side, contains the following information:

- the tyre inflation pressures, laden and unladen,
- the tyre sizes (including the tyre load index and speed rating),
- the inflation pressure for the spare wheel,
- the paint colour code.

i The tyre pressures must be checked when the tyres are cold, at least once a month.

🍀 If the tyre pressures are too low, this increases fuel consumption.

Emergency or assistance call



Localised Emergency Call



In an emergency, press this button for more than 2 seconds. Flashing of the green indicator lamp and a voice message confirm that the call has been made to the "Localised Emergency Call"* centre.

Pressing this button again immediately cancels the call.

The green indicator lamp goes off.

At any time, pressing this button for more than 8 seconds cancels the call.

The green indicator lamp remains on (without flashing) when communication is established. It goes off at the end of the call.

This call is dealt with by the "Localised Emergency Call" centre, which receives locating information from the vehicle and can send a detailed alert to the appropriate emergency services.

In countries in which a centre is not operational, or when the locating service has been expressly declined, the call is dealt with directly by the emergency services (112) without the vehicle location.

! If an impact is detected by the airbag control unit, and independently of the deployment of any airbags, an emergency call is made automatically.

i If you benefit from the CITROËN Connect Box offer with the SOS and assistance pack included, there are additional services available to you in your MyCITROËN personal space, via the Internet website for your country.

* These services are subject to conditions and availability.
Consult a CITROËN dealer.



Operation of the system



When the ignition is switched on, the green indicator lamp comes on for 3 seconds indicating that the system is operating correctly.



The orange indicator lamp flashes then goes off: the system has a fault.

The orange indicator lamp is on fixed: the back-up battery should be replaced.

In both cases, the emergency and assistance calls service may not work.

Contact a qualified repairer as soon as possible.

i The fault with the system does not prevent the vehicle being driven.

Localised Assistance Call



Press this button for more than 2 seconds to request assistance if the vehicle breaks down.

A voice message confirms that the call has been started*.

Pressing this button again immediately cancels the request.

The cancellation is confirmed by a voice message.

Geo-location



You can deactivate geo-location by simultaneously pressing the "Localised Emergency Call" and "Localised Assistance Call" buttons, followed by a press on "Localised Assistance Call" to confirm.

To reactivate geo-location, simultaneously press the "Localised Emergency Call" and "Localised Assistance Call" buttons again, followed by a press on "Localised Assistance Call" to confirm.

i If you purchased your vehicle outside the CITROËN dealer network, we invite you to have a dealer check the configuration of these services and, if desired, modified to suit your wishes. In a multi-lingual country, configuration is possible in the official national language of your choice.

i For technical reasons, particularly to improve the quality of Telematic services to customers, the manufacturer reserves the right to carry out updates to the vehicle's on-board telematic system.

* These services are subject to conditions and availability.
Consult a CITROËN dealer.

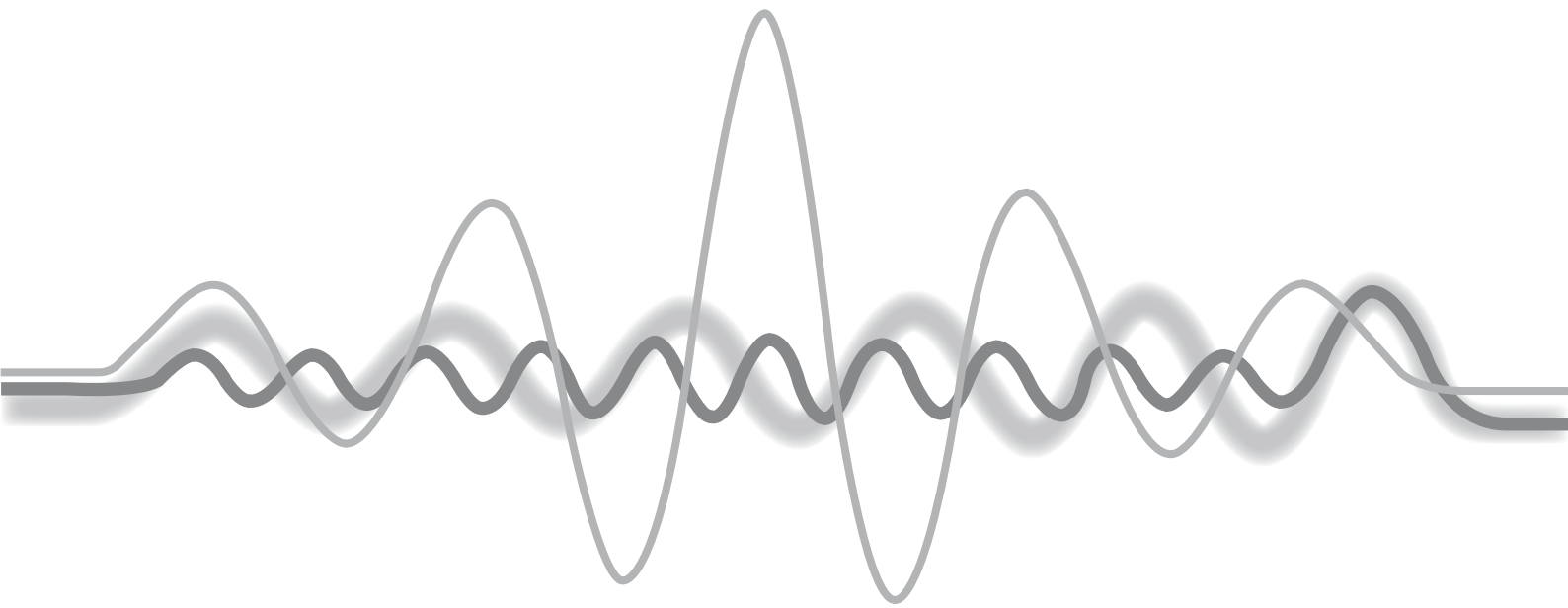

CITROËN Connect Nav

GPS satellite navigation - Connectivity - Multimedia audio - Bluetooth® telephone



| | Contents |
|----------------------------|----------|
| First steps | 342 |
| Steering mounted controls | 344 |
| Menus | 345 |
| Voice commands | 346 |
| Navigation | 352 |
| Connected navigation | 368 |
| Connectivity | 378 |
| Radio Media | 388 |
| Telephone | 400 |
| Settings | 412 |
| Frequently asked questions | 422 |

i The system is protected in such a way that it will only operate in your vehicle.

i The link below gives access to OSS (Open Source Software) codes for the system.
<http://www.psa-peugeot-citroen.com/oss>

! As a safety measure and because it requires sustained attention by the driver, the pairing of a Bluetooth mobile telephone with the Bluetooth hands-free system of your audio system must be done with the **vehicle stationary** and the ignition on. The display of the energy economy mode message signals that a change to standby is imminent. For more information on the **Energy economy mode** refer to the corresponding section.

First steps



With the engine running, a press mutes the sound.
With the ignition off, a press turns the system on.



Volume.

Use the buttons either side of the touch screen for access to the menus, then press the virtual buttons in the touch screen. All of the touch areas of the screen are white. Each menu is displayed in one or two pages (primary page and secondary page).

! The touch screen is of the "capacitive" type.
To clean the screen, use a soft, non-abrasive cloth (spectacles cloth) with no additional product.
Do not use sharp objects on the screen.
Do not touch the screen with wet hands.

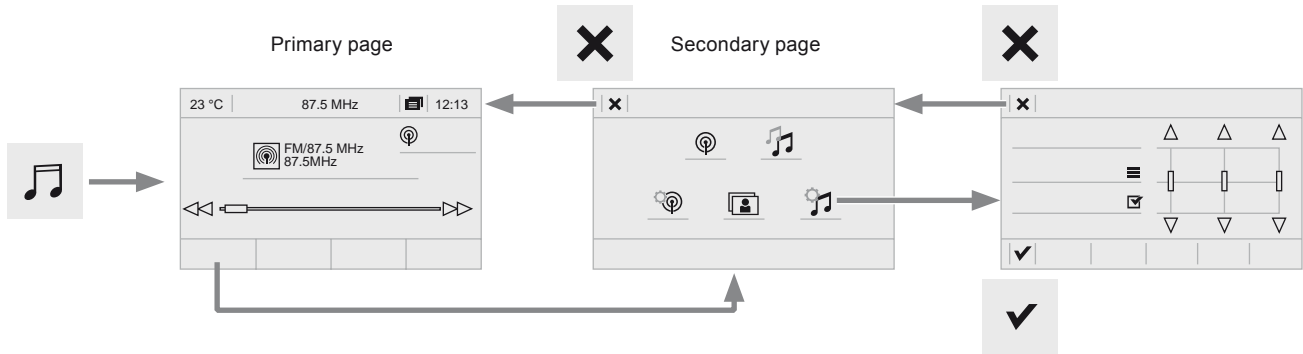

Short-cuts: using the virtual buttons in the upper band of touch screen, it is possible to go directly to the selection of audio source, the list of stations (or titles, depending on the source), message notifications, emails, mapping updates and, depending on services, navigation notifications.

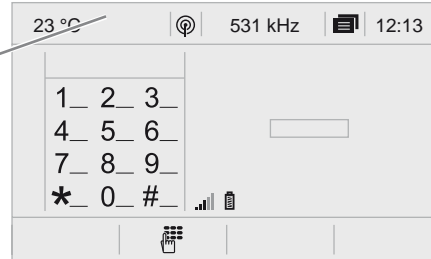

Select the audio source (depending on version):

- FM / DAB* / AM* stations.
- Smartphone via MirrorLink™ or CarPlay®.
- USB memory stick.
- Media player connected to the auxiliary socket (jack, cable not supplied).
- Telephone connected by Bluetooth* and using Bluetooth* audio streaming.

i In the "Settings" menu you can create a profile for just one person or a group of people with common points, with the possibility of entering a multitude of settings (radio presets, audio settings, navigation history, contact favourites, ...); these settings are taken into account automatically.

i In very hot conditions, the volume may be limited to protect the system. It may go into standby (screen and sound off) for at least 5 minutes. The return to normal takes place when the temperature in the passenger compartment drops.

* Depending on equipment.

Steering mounted controls



Voice commands:

Short press, system voice commands.

Long press, smartphone voice commands via the system.



Increase volume.



Mute / Restore the sound.



Decrease volume.



Media (short press): change the multimedia source.

Telephone (short press): call.

Call in progress (short press): access to telephone menu.

Telephone (long press): reject an incoming call, end call, access to telephone menu.



Radio (rotate): automatic search for the previous / next station.

Media (rotate): previous / next track, move in a list.

Short press: Confirm a selection.

Other than selection, access to presets.



Radio: display the list of stations.

Media: display the list of tracks.

Radio, press and hold: update the list of stations received.

Menus



Connected navigation

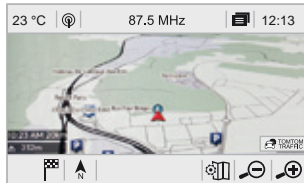

Enter navigation settings and choose a destination.

Use services available in real time, depending on equipment.



Telephone

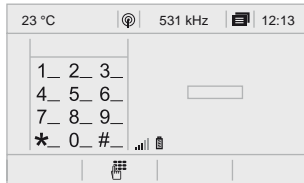

Connect a telephone by Bluetooth®, read messages and emails and send quick messages.



Connectivity

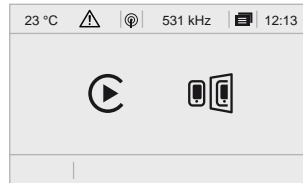

Operate certain applications on a smartphone connected via MirrorLink™ or CarPlay®.

Check the state of Bluetooth and Wi-Fi connections.



Settings

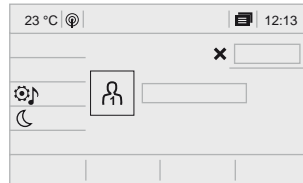

Enter settings for a personal profile and/or adjust the settings for sound (balance, ambience, ...), and the display (language, units, date, time, ...).



Radio Media

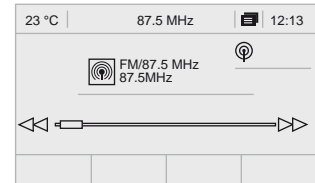

Select an audio source, a radio station, display photographs.



Driving

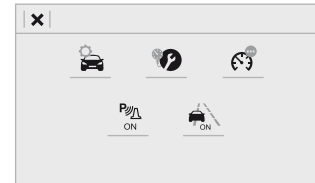

Activate, deactivate, adjust the settings for certain vehicle functions.

Voice commands

Steering mounted controls



Pressing this button activates the voice commands function.

- ! To ensure that voice commands are always recognised by the system, please observe the following recommendations:
 - speak in a normal tone without breaking up words or raising your voice.
 - always wait for the "beep" (audible signal) before speaking.
 - for best operation, it is recommended that the windows and opening roof (if fitted) be closed to avoid interference from extraneous noises.
 - before making a voice command, ask other passengers to not speak.

First steps



Example of a "voice command" for navigation:

"Navigate to address 11 Regent Street, London".

Example of a "voice command" for the radio and media:

"Play artist Madonna".

Example of a "voice command" for the telephone:

"Call David Miller".

- ! The voice commands, with a choice of 12 languages (English, French, Italian, Spanish, German, Dutch, Portuguese, Polish, Turkish, Russian, Arabic, Brazilian), are made using the language previously chosen and set in the system.

The voice commands in Arabic for: "Navigate to address" and "Display POI in the city", are not available.

Information - Using the system





Press the Push To Talk button and tell me what you'd like after the tone. Remember you can interrupt me at any

time by pressing this button. If you press it again while I'm waiting for you to speak, it'll end the conversation. If you need to start over, say "cancel". If you want to undo something, say "undo". And to get information and tips at any time, just say "help". If you ask to me do something and there's some information missing that I need, I'll give you some examples or take you through it step by step. There's more information available in "novice" mode. You can set the dialogue mode to "expert" when you feel comfortable.



Global voice commands

i These commands can be made from any screen page after pressing the voice command or telephone button located on the steering wheel, as long as there is no telephone call in progress.

|  "Voice command" |  Help message |
|--|---|
| Help | <p>There are lots of topics I can help you with. You can say: "help with phone", "help with navigation", "help with media" or "help with radio". For an overview on how to use voice controls, you can say "help with voice controls".</p> |
| Voice command help | |
| Navigation help | |
| Radio help | |
| Media help | |
| Telephone help | |
| Set dialogue mode as <...> | Select "beginner" or "expert" mode. |
| Select profile <...> | Select profile 1, 2 or 3. |
| Yes | Say "yes" if I got that right. Otherwise, say "no" and we'll start that again. |
| No | |

"Navigation" voice commands



i These commands can be issued from any screen page after pressing the voice command or telephone button on the steering wheel, as long as there is no telephone call in progress.

|  "Voice command" |  Help message |
|--|--|
| Navigate home | <p>To start guidance or add a stopover, say "navigate to" and then the address or contact name.</p> <p>For example, "navigate to address 11 Regent Street, London", or "navigate to contact, John Miller".</p> <p>You can specify if it's a preferred or recent destination. For example, "navigate to preferred address, Tennis club", "navigate to recent destination, 11 Regent Street, London".</p> <p>Otherwise, just say, "navigate home". To see points of interest on a map, you can say things like "show hotels in Banbury" or "show nearby petrol station".</p> <p>For more information you can ask for "help with route guidance".</p> |
| Navigate to work | |
| Navigate to preferred address <...> | |
| Navigate to contact <...> | |
| Navigate to address <...> | |
| Show nearby POI <...> | |
| Remaining distance | |
| Remaining time | |
| Arrival time | |
| Stop route guidance | |

i Depending on the country, give the destination instructions (address) in the language used by the system.

"Radio Media" voice commands



i These commands can be issued from any screen page after pressing the voice command or telephone button on the steering wheel, as long as there is no telephone call in progress.

|  "Voice command" |  Help message |
|--|--|
| Tune to channel <...> | <p>You can pick a radio station by saying "tune to" and the station name or frequency. For example "tune to channel Talksport" or "tune to 98.5 FM". To listen to a preset radio station, say "tune to preset number". For example "tune to preset number five".</p> |
| What's playing | <p>To display the details of the current "track", "artist" and "album", you can say "What's playing"</p> |
| Play song <...> | <p>Use the command "play" to select the type of music you'd like to hear. You can pick by "song", "artist", or "album". Just say something like "play artist, Madonna", "play song, Hey Jude", or "play album, Thriller".</p> |
| Play artist <...> | |
| Play album <...> | |

i Media voice commands are available only for a USB connection.

"Telephone" voice commands



- If a telephone is connected to the system, these voice commands can be issued from any main screen page after pressing the telephone button on the steering wheel, as long as there is no telephone call in progress.
- If there is no telephone connected by Bluetooth, a voice message announces: "Please first connect a telephone" and the voice session will be closed.

|  "Voice command" |  Help message |
|--|---|
| Call contact <...>* | <p>To make a phone call, say "call" followed by the contact name, for example: "Call David Miller".</p> <p>You can also include the phone type, for example: "Call David Miller at home".</p> <p>To make a call by number, say "dial" followed by the phone number, for example, "Dial 107776 835 417".</p> <p>You can check your voicemail by saying "call voicemail".</p> <p>To send a text, say "send quick message to", followed by the contact, and then the name of the quick message you'd like to send.</p> <p>For example, "send quick message to David Miller, I'll be late".</p> <p>To display the list of calls, say "display calls". For more information on SMS, you can say "help with texting".</p> |
| Dial <...>* | |
| Display contacts* | |
| Display calls* | |
| Call (message box voicemail)* | |

* This function is available only if the telephone connected to the system supports downloading of contacts and recent calls and if the download has been done.

"Test message" voice commands

- If a telephone is connected to the system these voice commands can be issued from any main screen page after pressing the telephone button on the steering wheel, as long as there is no telephone call in progress.
If no telephone has been connected by Bluetooth, a voice message announces: "Please first connect a telephone" and the voice session will be closed.









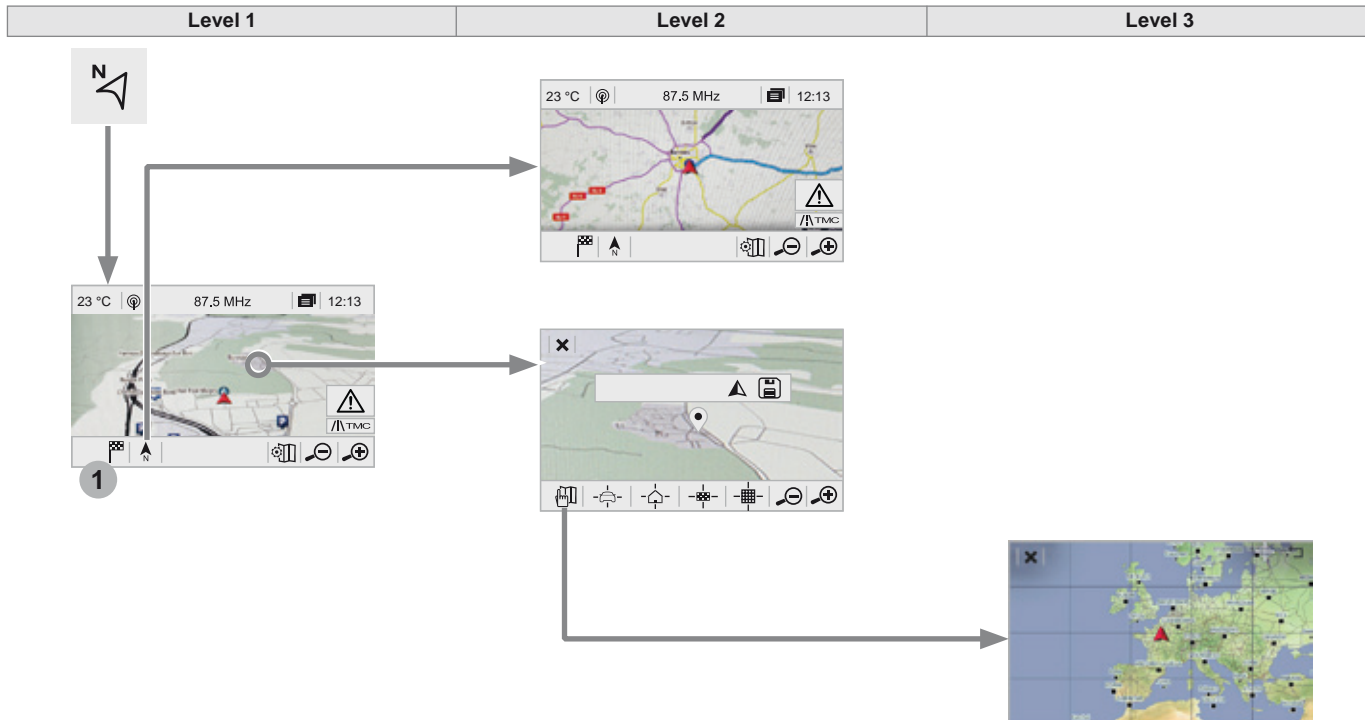











|  "Voice command" |  Help message |
|--|--|
| Send text to <...> | <p>To hear your messages, you can say "listen to most recent message". When you want to send a text, there's a set of quick messages ready for you to use. Just use the quick message name and say something like "send quick message to Bill Carter, I'll be late". Check the phone menu for the names of the supported messages.</p> |
| Listen to most recent message* | <p>Please say "call" or "send quick message to", and then select a line from the list. To move around a list shown on the display, you can say "go to start", "go to end", "next page" or "previous page". To undo your selection, say "undo". To cancel the current action and start again, say "cancel".</p> |

- The system only sends predefined "Quick messages".



* This function is only available if the telephone connected to the system supports downloading of contacts and recent calls and if the download has been done.

Navigation



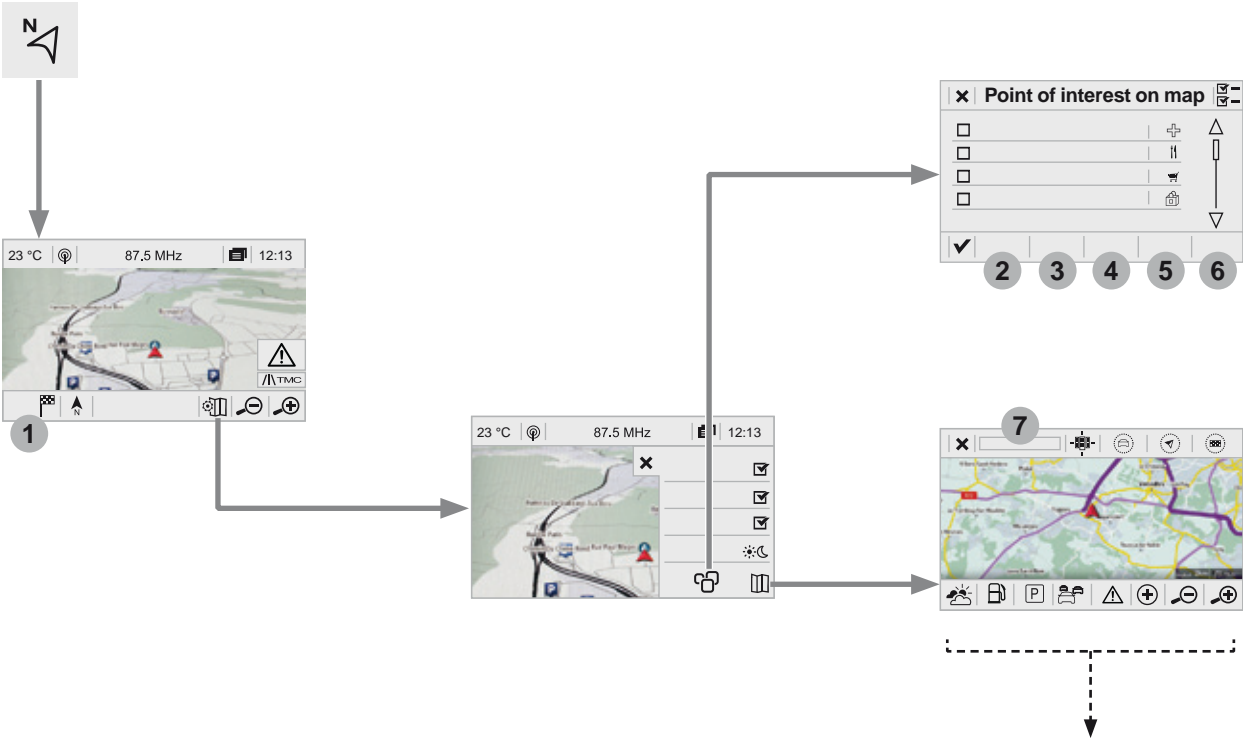





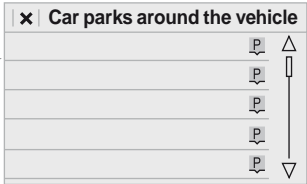
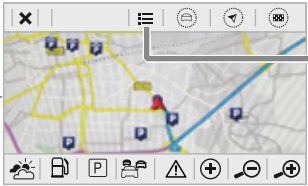
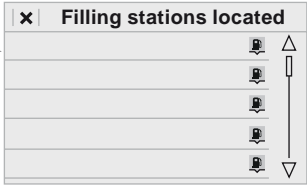
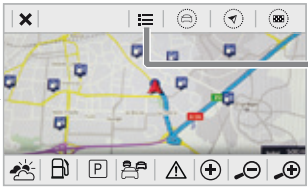
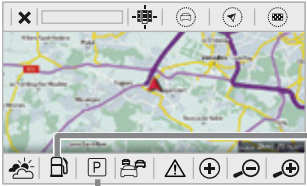
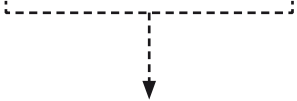













| Level 1 | | Level 2 | | Level 3 | | Comments | |
|--|---|---|------------------------|---|---------------------------|---|--|
|   | Navigation ↓  | | | | | Select the orientation of the map; north up, vehicle direction up or perspective. | |
|   | Navigation ↓  | | | | | Display the traffic information available. | |
|  | Navigation |  | World map |  | | Manually locate an area on the world map or enter the latitude and longitude coordinates. | |
| | | | |  | | | |
| | |  | Around the vehicle | | | | Display the location criteria selected. |
| | |  | Around home | | | | |
| | |  | Around the destination | | | | |
| | |  | 2D mode | | | | Switch to a 2D map. |
| | |  | | | | | Zoom out. |
| | |  | | | | | Zoom in. |
| | |  | | | | | Start navigation to the current address. |
|  | | | | | Save the current address. | | |
|  | | | | | | Zoom out. | |
|  | | | | | | Zoom in. | |







| Level 1 | | Level 2 | | Level 3 | | Comments | |
|--|-------------------------------------|-------------------------------------|-------------------|-------------|---------------------------------|--|--|
|  <p>Navigation</p>  | <input checked="" type="checkbox"/> | Stations | | | | Activate or deactivate the content available (stations, car parks, risk areas and danger areas). | |
| | | <input checked="" type="checkbox"/> | | | | | Car park |
| | | <input checked="" type="checkbox"/> | | | | | Danger area |
| | | | Map color | | | | Select day or night mode for display of the map. |
| | | | POI on map | | Travel | | Select the POIs available. |
| | | | | | Active life | | |
| | | | | | Commercial | | |
| | | | | | Public | | |
| | | | | | Geographic | | |
| | | | | | Select all | | |
| | | | | Confirm | Save your choice or selection. | | |
| | | | View map | | Modify city | Select or modify a city. | |
| | | | | | Weather | Display on the map the content available in non-connected mode. | |
| | | | | | Petrol Station | | |
| | | | | | Car park | | |
| | | | | Traffic | | | |
| | | | | Danger area | | | |
| | | | | Select POI | Select from the POIs available. | | |
| | | | | | Zoom out. | | |
| | | | | | Zoom in. | | |

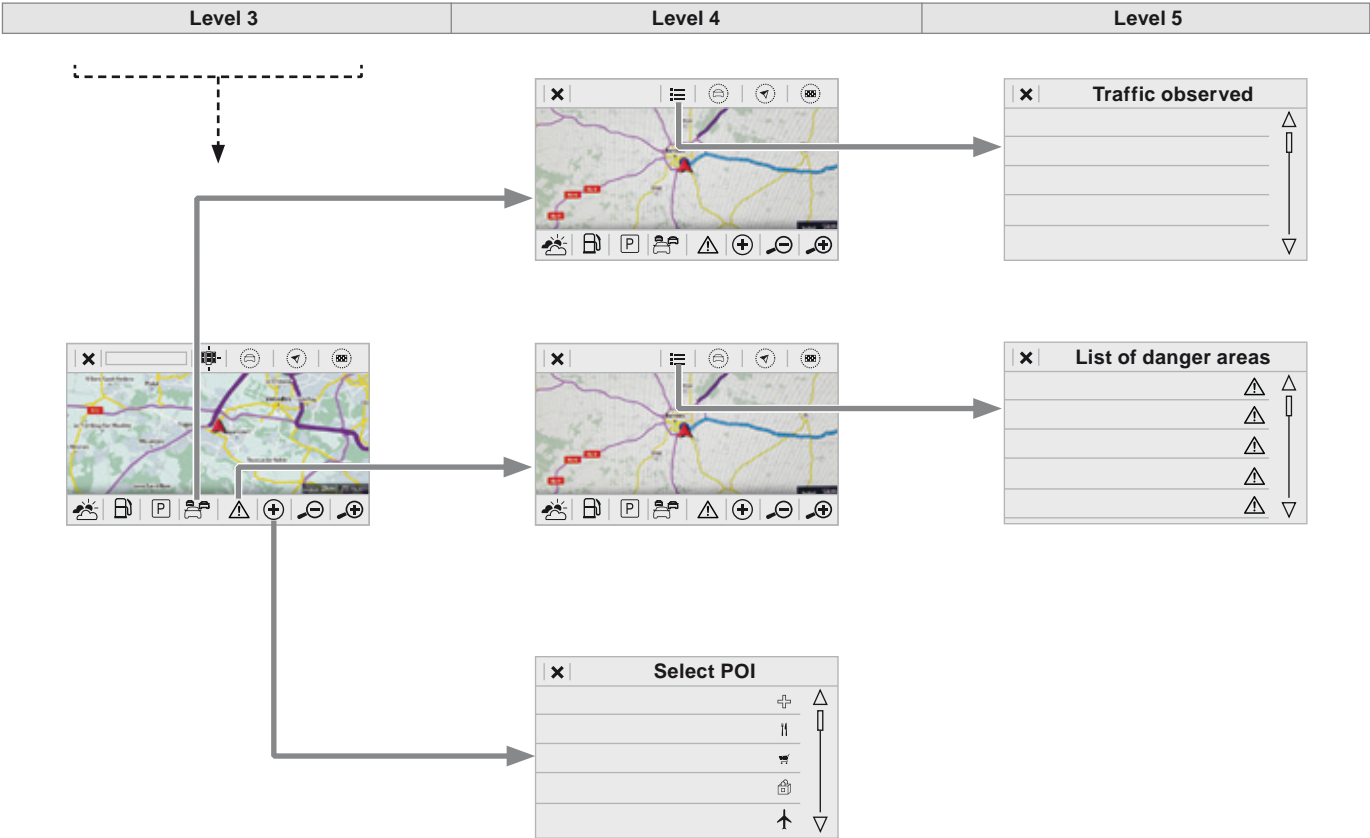







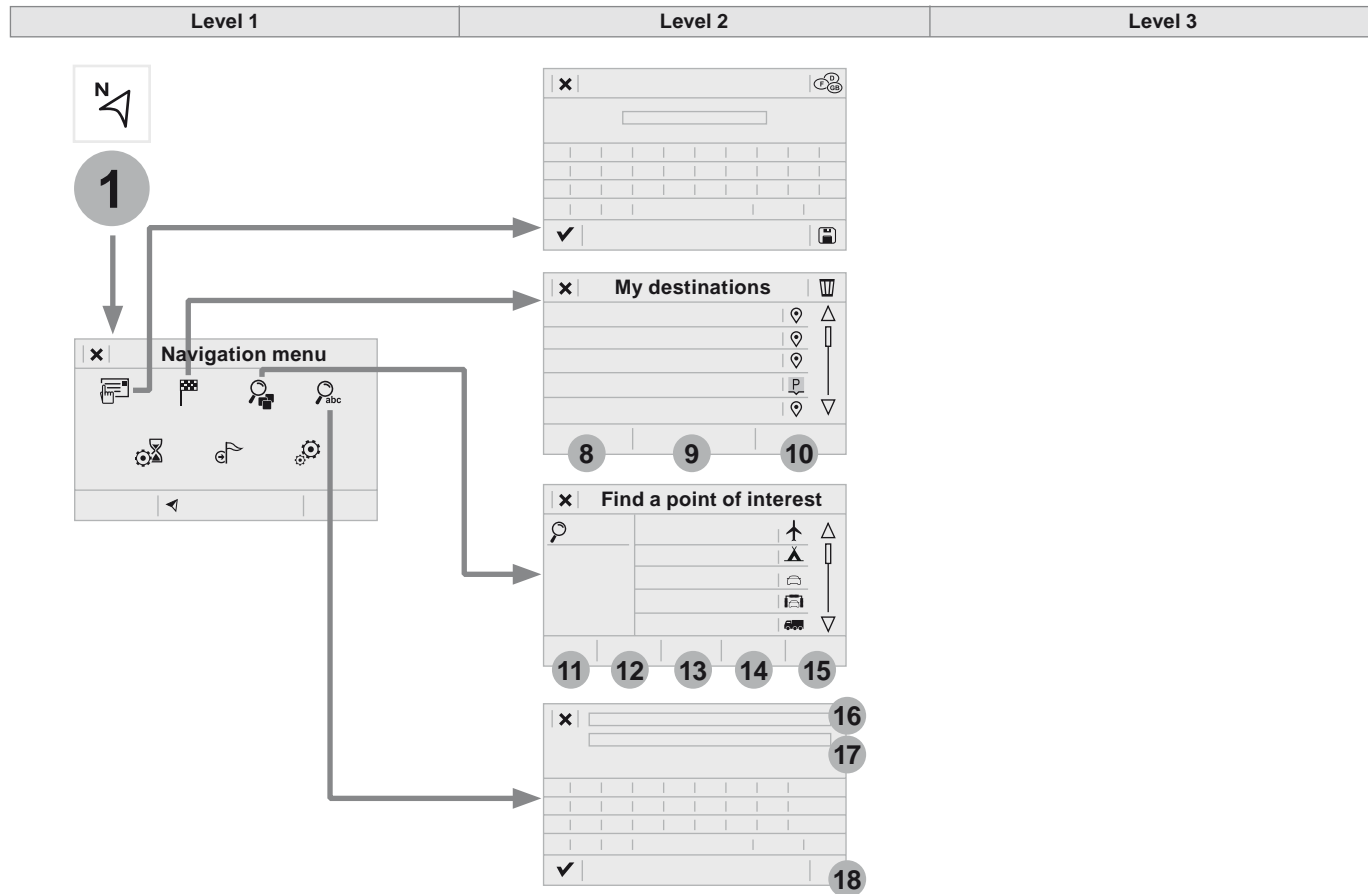





| Level 3 | | Level 4 | | Level 5 | | Comments |
|---|--------------------|---|---------|---|-------------------------------------|--|
|  | Zoom in | ✓ | Confirm | | | Zoom in around the city selected. |
|  | Around the vehicle | | | | | Select a location option. |
|  | On the route | | | | | |
|  | At the destination | | | | | |
|  | Weather | | | | | Weather information transmitted in TMC mode. |
|  | Filling stations |  | |  | Filling stations around the vehicle | Display the list of POIs. |
| | |  | |  | Filling stations on the route | |
| | |  | |  | Filling stations at the destination | |
|  | Car park |  | |  | Car parks around the vehicle | |
| | |  | |  | Car parks on the route | |
| | |  | |  | Car parks at the destination | |
|  | | | | | | Zoom out. |
|  | | | | | | Zoom in. |









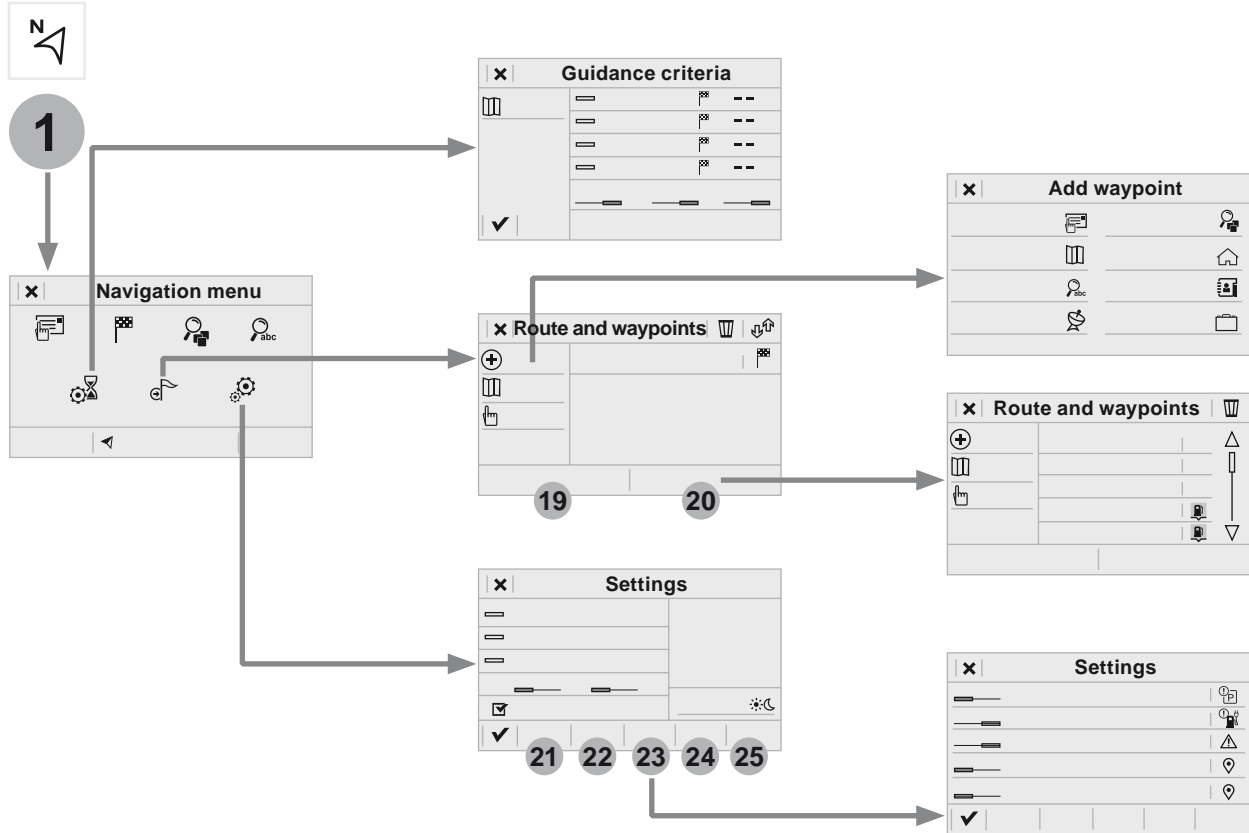











| Level 3 | | Level 4 | | Level 5 | | Comments |
|---|-------------|---------|--|---|----------------------|---|
|  | Traffic | | |  | Traffic observed | Traffic information sent in real time. |
|  | Danger area | | |  | List of danger areas | Display the list of danger areas (roadworks, breakdowns, accidents, ...). |
|  | Select POI | | | | | Configure a category of POI to display. |



| Level 1 | | Level 2 | | Level 3 | | Comments |
|---|--------------------|---|-------------------|---|--|--|
|  1 | Navigation |  | | | | Select the country. |
| | Secondary page |  | | | | Save the current address. |
| | Enter address |  | Confirm | | | Confirm the current address. |
|  1 | Navigation | 8 | Recent | | | Display the lists of destinations and start navigation. |
| | Secondary page | 9 | Preferred |  My home | | |
| | My destinations | 10 | Contact |  My work | | |
| | |  | | | | |
|  1 | Navigation | 11 | Travel | | | List of categories available. After selection of category, select the point of interest. |
| | Secondary page | 12 | Active life | | | |
| | Points of interest | 13 | Commercial | | | |
| | | 14 | Public | | | |
| | | 15 | Geographic | | | |
| | |  | Search | | | Search for a point of interest. |
|  1 | Navigation | 16 | Point of interest | | | Enter a point of interest. |
| | Secondary page | 17 | Address | | | Enter the address of a point of interest. |
| | Search | 18 | Local / Connected | | | Enter settings for the POI search mode in a local or connected database depending on the services subscribed to. |
| | |  | Confirm | | | Confirm the entry. |



| Level 1 | | Level 2 | | Level 3 | | Comments | | |
|--|--|---|--|---|--|--|-------------------------------------|--|
|  1  | Navigation ↓ Secondary page ↓ Guidance criteria |  Fast | | | | Select the guidance criteria (motorways, tolls and how traffic is taken into account). | | |
| | |  Short | | | | | | |
| | |  Compromise | | | | | | |
| | | | |  Ecological | | | | |
| | | | |  See on map | | | | Display the route selected using the criteria. |
| | | | |  Confirm | | | | Save your selections. |
|  1  | Navigation ↓ Secondary page ↓ Routes / waypoints | 19 Waypoints | | | | Display the waypoints saved. | | |
| | | 20 Route | | | | | Display details of the route. | |
| | |  Add waypoint | | Add a waypoint | | | Add a waypoint from a list offered. | |
| | |  Preview | | | | | Display the map. | |
| | |  Finish | | | | | Press to calculate the route. | |
| | |  | | | | | Delete one or more waypoints. | |
| | |  | | | | | Move a waypoint in the list. | |
|  1  | Navigation ↓ Secondary page ↓ Settings | 21 Aspects | | | | Enter choices and select the volume for the voice and stating the names of streets. | | |
| | | 22 Options | | | | | | |
| | | 23 Alerts | | | | | | |
| | | 24 Vocal | | | | | | |
| | | 25 Mapping | | | | | | |
| | |  Confirm | | | | | Save the selections adopted. | |

Choosing a new destination

Towards a new destination



Press **Navigation** to display the primary page.



Press the "**MENU**" button to go to the secondary page.



Select "**Enter address**".



Select the "**Country**".



Enter the "**City**", the "**Street**" and the "**Number**" and confirm by pressing on the suggestions displayed.



Press "**Confirm**" to select the "**Guidance criteria**".

And / Or



Select "**See on map**" to select the "**Guidance criteria**".



Press "**Confirm**" to start navigation.

i To use the navigation system, it is necessary to enter the "**City**", the "**Street**" and the "**Number**" using the virtual keypad, or to take them from the list of "**Contacts**" or from the "**History**" of addresses.

i Without confirmation of the street number, you will be guided to one end of the street.

Towards a recent destination



Press **Navigation** to display the primary page.



Press the "**MENU**" button to go to the secondary page.



Select "**My destinations**".



Select the "**Recent**" tab.

Select the address chosen in the list to display the "**Guidance criteria**".



Press "**Confirm**" to start navigation.

i Select "**Position**" to see the point of arrival geographically.

Towards "My home" or "My work"



Press **Navigation** to display the primary page.



Press the "**MENU**" button to go to the secondary page.



Select "**My destinations**".



Select the "**Preferred**" tab.



Select "**My home**".

Or



Select "**My work**".

Or

Select a previously saved favourite destination.

Towards a contact



Press **Navigation** to display the primary page.



Press the "**MENU**" button to go to the secondary page.



Select "**My destinations**".



Select the "**Contact**" tab.

Select a contact in the list offered to start navigation.

Towards points of interest (POI)

Points of Interest (POI) are listed in different categories.



Press **Navigation** to display the primary page.



Press the "**MENU**" button to go to the secondary page.



Select "**Points of interest**".



Select the "**Travel**", or "**Leisure**" or "**Commercial**" or "**Public**" or "**Geographic**" tab.

Or



Select "**Search**" to enter the name and address of a POI.



Press "**Confirm**" to start calculation of the route.

Towards a point on the map



Press **Navigation** to display the primary page.

Explore the map by sliding a finger on the screen.

Select the destination by pressing on the map.



Tap the screen to place a marker and display the sub-menu.



Press this button to start navigation.

Or



Press this button to save the address displayed



A long press on a point opens a list of POIs nearby.

Towards GPS coordinates



Press **Navigation** to display the primary page.

Explore the map by sliding a finger on the screen.



Press this button to display the world map. Using the grid, select by zoom the desired country or region.



Press this button to enter the GPS coordinates.



A marker is displayed in the middle of the screen, with the "**Latitude**" and "**Longitude**" coordinates.



Press this button to start navigation.

Or



Press this button to save the address displayed.

Or



Press this button to enter the value for "**Latitude**" using the virtual keypad.

And



Press this button to enter the value for "**Longitude**" using the virtual keypad.

TMC (Traffic Message Channel)

i TMC (Traffic Message Channel) is a European standard on the broadcasting of traffic information via the RDS system on FM radio, transmitting traffic information in real time. The TMC information is then displayed on a GPS Navigation system map and taken into account straight away during navigation, so as to avoid accidents, traffic jams and closed roads.

i The display of danger areas depends on the legislation in force and subscription to the service.

Connected navigation

Depending on the equipment level of the vehicle

Network connection provided by the vehicle



OR

Network connection provided by the user

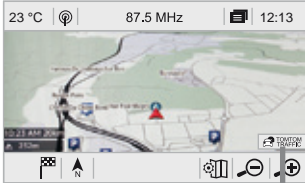
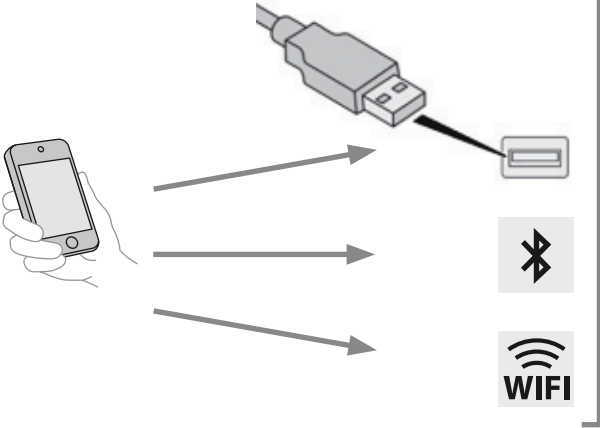

Connected navigation connection

! As a safety measure and because it requires sustained attention by the driver, using a smartphone when driving is prohibited. All operations must be done with the **vehicle stationary**.

i For access to connected navigation, you can use the connection provided by the vehicle via the "Emergency or assistance call" services or use your smartphone as a modem.

Activate and enter settings for sharing the smartphone connection.

Network connection provided by the vehicle



The system is automatically connected to the modem included for the "Emergency or assistance calls" services and does not require a connection provided by the user via their smartphone.

Network connection provided by the user

USB connection



Connect the USB cable. The smartphone is in charge mode when connected by USB cable.

Bluetooth connection



Activate the Bluetooth function on the telephone and ensure that it is visible to all (see the "Connectivity" section).

Wi-Fi connection



Select a Wi-Fi connection found by the system and connect to it (see the "Connectivity" section).

- i** Restrictions of use:
- With CarPlay®, connection sharing is only with a Wi-Fi connection.
 - With MirrorLink™, connection sharing is only with a USB connection.

The quality of services depends on the quality of the network connection.









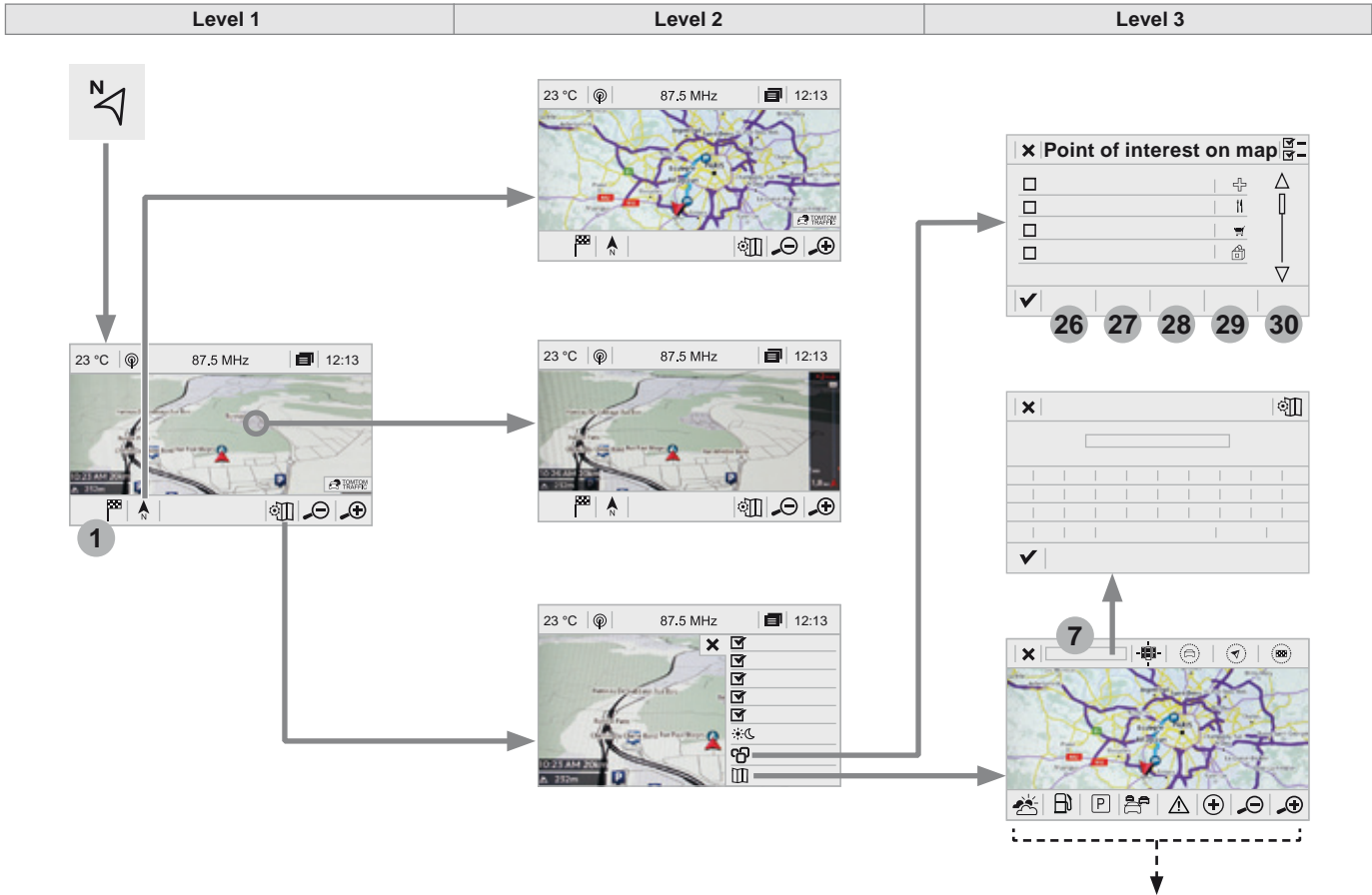











On the arrival of "TOMTOM TRAFFIC", the services are available.









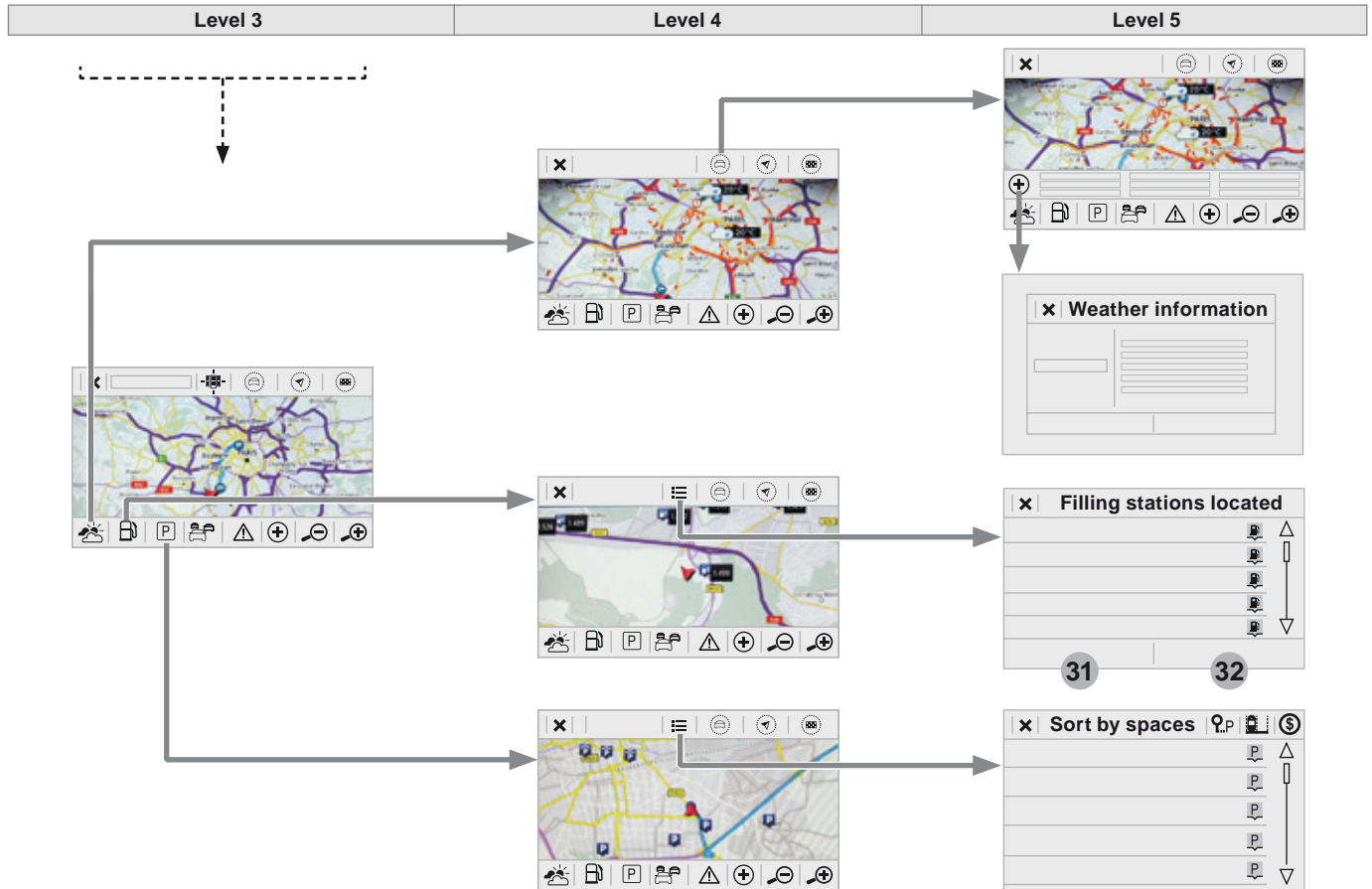



















- i** The services offered with connected navigation are as follows. A connected services pack:
- Weather,
 - Filling stations,
 - Car park,
 - Traffic,
 - POI, local search.
- A Danger area pack.

- i** The principles and standards are constantly changing. For communication between your smartphone and the system to operate correctly, we recommend that you **keep your smartphone's operating system up to date, and the time and date on your smartphone and the system correct.**







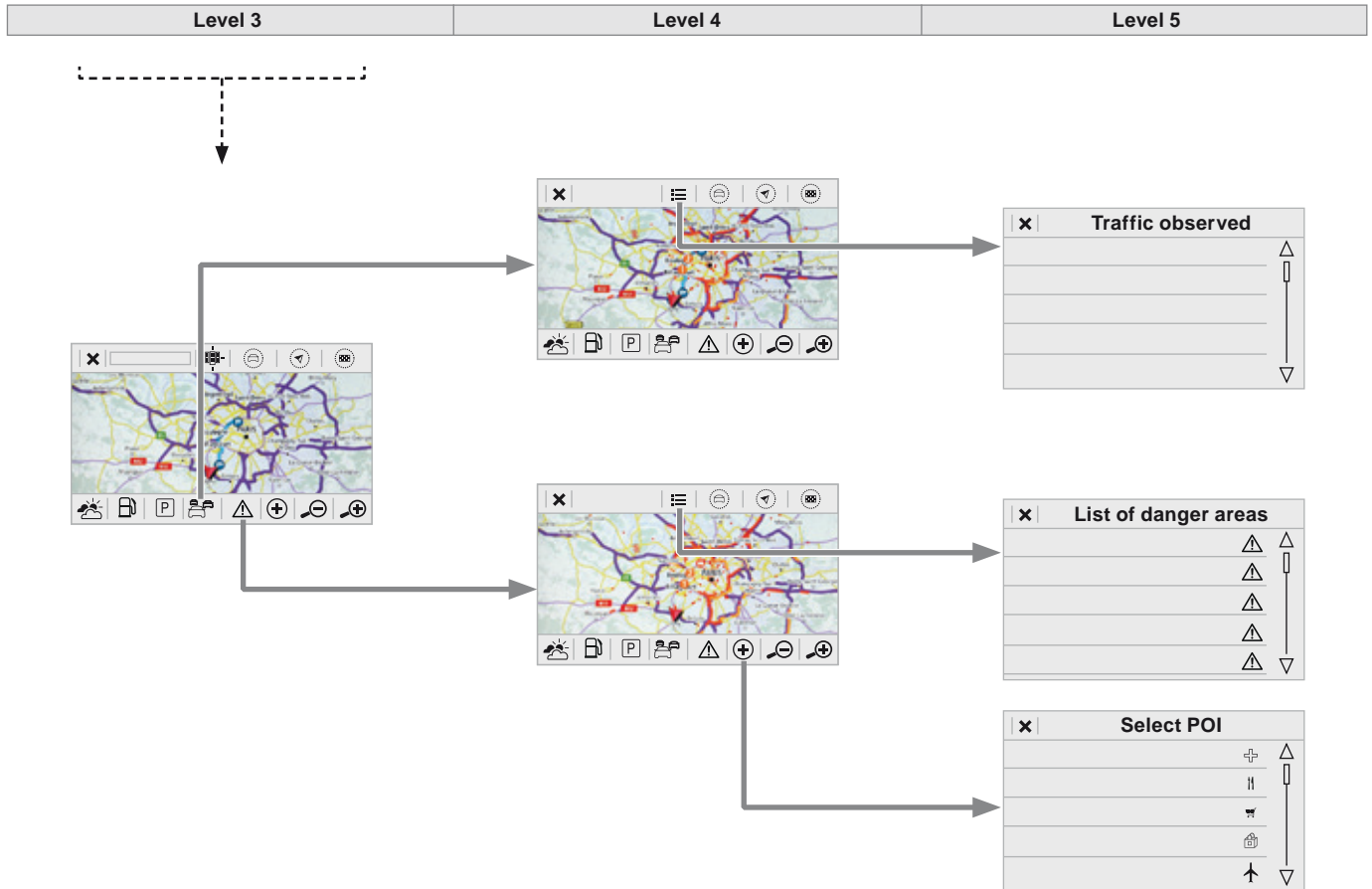

| Level 1 | | Level 2 | | Level 3 | | Comments |
|--|---|---|--|--------------------------|--|--|
|  | Navigation ↓  | | | | | Select the orientation of the map; north up, vehicle direction up or perspective. |
|   | Navigation ↓ TOMTOM TRAFFIC | | | | | On connection of the system to a network, "TOMTOM TRAFFIC" is displayed instead of "TMC", for use of all of the options available, in real time. |
|   | Navigation ↓  | <input checked="" type="checkbox"/> Weather | | | | Select the options. The map display the route chosen, depending on options. |
| | | <input checked="" type="checkbox"/> Stations | | | | |
| | | <input checked="" type="checkbox"/> Car park | | | | |
| | | <input checked="" type="checkbox"/> Traffic | | | | |
| | | <input checked="" type="checkbox"/> Danger area | | | | |
| | |  Map color | | | | Select the display mode for the map. |
| | |  POI on map | | |  Commercial | Select the POIs available. |
| | | | | |  Geographic | |
| | | |  Leisure | | | |
| | | |  Public | | | |
| | | |  Travel | | | |
| | | | <input checked="" type="checkbox"/> Confirm | Save the options. | | |
|  View map | | |  7 Modify city | Select or change a city. | | |
|  | | | | | Zoom out. | |
|  | | | | | Zoom in. | |









| Level 3 | | Level 4 | | Level 5 | | Comments |
|--|--------------------|---|---------|---|-------------------------------------|---|
|  | Select city | ✓ | Confirm | | | Select or change a city. |
|  | Around the vehicle | | | | | Select or change a city. |
|  | On the route | | | | | |
|  | At the destination | | | | | |
|  | Weather |  | |  | Weather information | Display the weather forecast for the day or the following days. |
|  | Filling stations |  | |  | Filling stations around the vehicle | Display the list of filling stations and the associated information (address, prices, fuels, ...). |
| | |  | |  | Filling stations on the route | |
| | |  | |  | Filling stations at the destination | |
| | |  | | 31 | By distance | |
| | | | | 32 | By price | |
|  | Car park |  | |  | Car parks around the vehicle | Display the list of car parks and the associated information (address, distance, spaces available, price, ...). |
| | |  | |  | Car parks on the route | |
| | |  | |  | Car parks at the destination | |
| | |  | |  | Sort by distance | |
| | | | |  | Sort by spaces | |
| | | | |  | Sort by price | |
|  | | | | | | Zoom out. |
|  | | | | | | Zoom in. |









| Level 3 | | Level 4 | | Level 5 | | Comments |
|---|--------------------|---|--------------------|---|----------------------|--|
|  | Traffic | | |  | Traffic observed | Display traffic information in real time: type, description and duration (in minutes). |
|  | Danger areas | | |  | List of danger areas | Display danger areas (roadworks, breakdowns, accidents, ...) in real time. |
|  | Points of interest |  | Points of interest | | Select POI | Display the list of POIs for the location selected. |

Display the weather

-  Press **Navigation** to display the primary page.
-  Press this button to display the list of services.
-  Select "**View map**".
-  Select "**Weather**".
-  Press this button to display the first level of information.
-  Press this button to display the detailed weather information.

i The temperature displayed at 6 o'clock in the morning will be the maximum temperature for the day. The temperature displayed at 6 o'clock in the evening will be the minimum temperature for the night.

Settings specific to connected navigation

-  Press **Navigation** to display the primary page.
-  Press the "**MENU**" button to go to the secondary page.
-  Select "**Settings**".
-  Select "**Options**".
-  Activate or deactivate:
 - "**Allow declaration of danger areas**"
 - "**Guidance to final destination on foot**"
 - "**Authorise sending information**"
-  Select "**Alerts**".
-  Activate or deactivate "**Warn of danger zones**".

! For access to connected navigation, you have to select the option: "**Authorise sending information**".

i The display of danger zones is conditioned by the legislation in force and subscription to the service.

Declaration of "Danger areas"

 To distribute information on the declaration of danger zones, you should check the option: "**Allow declaration of danger areas**".



Press **Navigation** to display the primary page.



Press the "Declare a new danger area" button located in the upper bar of the touch screen.



Select the option "**Type**" to choose the type of "Danger area".



Select the "**Speed**" option and enter it using the virtual keypad.



Press "**Confirm**" to save and distribute the information.







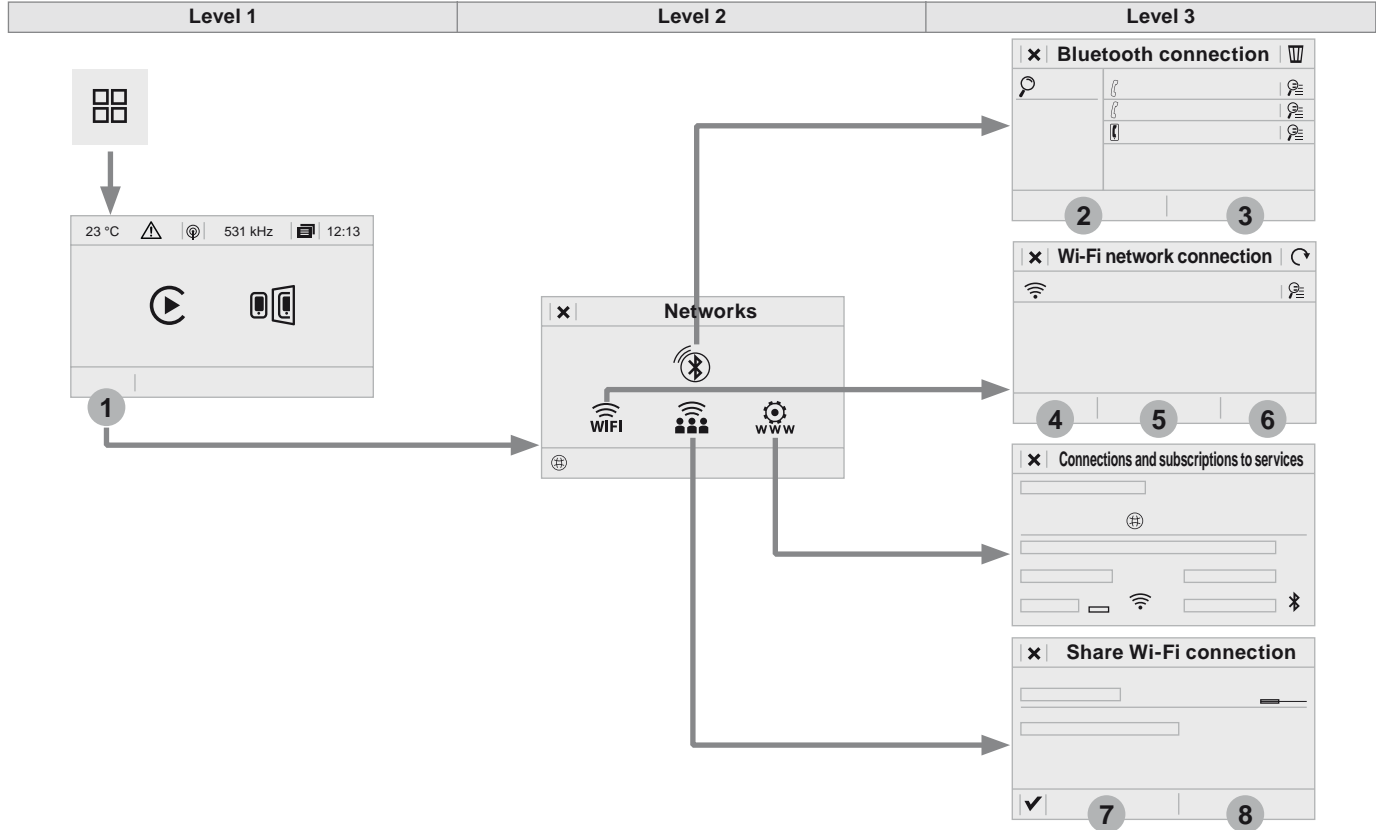



 You can download updates to the system, danger zones and mapping, from the brand's website. The download procedure can be found in the same place.

Connectivity

Functionalities available according to equipment.



Functionalities available according to equipment.

| Level 2 | | Level 3 | | Comments |
|---|--|---|-------------|---|
|  1  | Connectivity ↓ Secondary page ↓ Bluetooth connection | 2 | All | Display all telephones, connected or disconnected. |
| | | 3 | Connected | Display all connected telephones. |
| | |  | Search | Start a search for a device to connect. |
|  1  | Connectivity ↓ Secondary page ↓ Wi-Fi network connection | 4 | Secured | Display secured Wi-Fi networks. |
| | | 5 | Not secured | Display non-secured Wi-Fi networks. |
| | | 6 | Stored | Display remembered Wi-Fi networks. |
|  1   | Connectivity ↓ Secondary page ↓ Manage connection | | | Display the state of the subscription to connected services, the state of the network connection and the connection mode. |
|  1  | Connectivity ↓ Secondary page ↓ Share Wi-Fi connection | 7 | Activation | Activate or deactivating the sharing of the Wi-Fi connection. |
| | | 8 | Settings | Select a Wi-Fi network found by the system and connect to it. |
| | | ✓ | | Save settings. |

Bluetooth® connection

! As a safety measure and because it requires sustained attention by the driver, the pairing of a Bluetooth mobile telephone with the Bluetooth hands-free system of your audio system must be done with the **vehicle stationary** and the ignition on.

i Activate the Bluetooth function on the telephone and ensure that it is "visible to all" (telephone configuration).

Procedure from the telephone



Select the name of the system in the list of devices detected.

In the system, accept the connection request from the telephone.

! To complete the pairing, whichever procedure used (from the telephone or from the system), ensure that the code is the same in the system and in the telephone.

Procedure from the system



Press on "**Telephone**" to display the secondary page.

1

Press on the "**OPTIONS**" button to go to the secondary page.



Press on "**Bluetooth connection**".



Select "**Search**".
The list of detected telephones is displayed.



If the pairing procedure fails, it is recommended that you deactivate and then reactivate the "Bluetooth" function in your telephone.



Select the name of the chosen telephone in the list.



Depending on the type of telephone, you may be asked to accept or not the transfer of your contacts and messages.

Connection sharing

The system offers to connect the telephone with 3 profiles:

- "**Telephone**" (hands-free kit, telephone only),
- "**Streaming**" (wireless play of audio files on the telephone),
- "**Mobile internet data**".



The "**Mobile internet data**" profile must be activated for connected navigation (where the vehicle does not have "Emergency and assistance call" services), having first activated sharing of this connection on your smartphone.



Select one or more profiles.



Press on "**Confirm**".

Wi-Fi connection

Network connection by the smartphone Wi-Fi.



Press "**Connectivity**" to display the primary page.

1

Press the "**OPTIONS**" button to go to the secondary page.



Select "**Wi-Fi network connection**".



Select the "**Secured**", "**Not secured**" or "**Stored**" tab.



Select a network.



Using the virtual keypad, enter the "**Key**" for the Wi-Fi network and the "**Password**".



Press "**Confirm**" to start the connection.

i The Wi-Fi connection and the sharing of the Wi-Fi connection are exclusive.

Sharing the Wi-Fi connection

Creation of a local Wi-Fi network by the system.



Press **Connectivity** to display the primary page.

1

Press the "**OPTIONS**" button to go to the secondary page.



Select "**Share Wi-Fi connection**".

7

Select the "**Activation**" tab to activate or deactivate sharing of the Wi-Fi connection.

And / Or

8

Select the "**Settings**" to change the name of the system network and the password.



Press "**Confirm**".

i To protect from any piracy and provide maximum security for your systems, it is recommended that you use a security code or complex password.

Managing connections



Press **Connectivity** to display the primary page.

1

Press the "**OPTIONS**" button to go to the secondary page.



Select "**Manage connection**".

With this function you can view the access to connected services, the availability of connected services and modify the connection mode.

MirrorLink™ smartphone connection

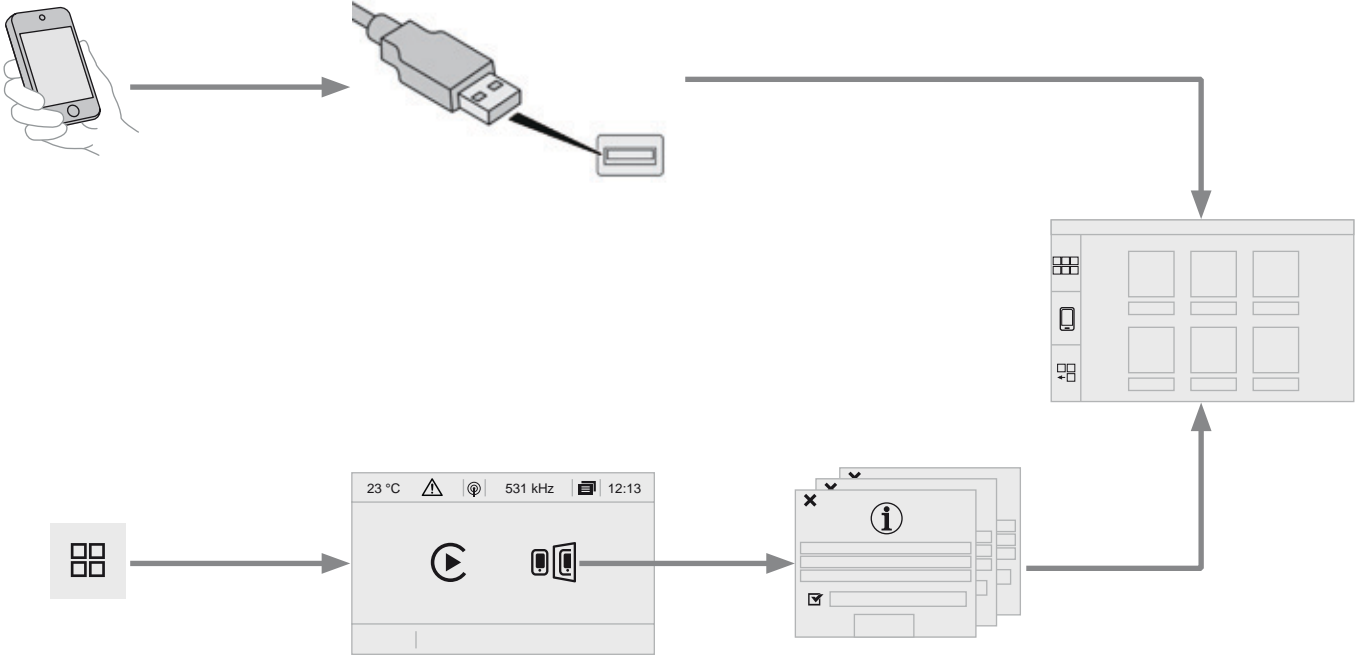

! As a safety measure and because it requires the sustained attention of the driver, using a smartphone when driving is prohibited. Operation must be with the **vehicle stationary**.

i The synchronisation of a smartphone allows applications on a smartphone that are adapted to the MirrorLink™ technology to be displayed in the vehicle's screen. The principles and standards are constantly evolving. For the communication process between the smartphone and the system to work correctly, the smartphone must be unlocked; **update the operating system of your smartphone as well as the date and time in the smartphone and the system**. For the list of eligible smartphones, connect to the brand's internet website in your country.

! As a safety measure, applications can only be viewed with the vehicle stationary; display is interrupted once the vehicle is moving.

i The "**MirrorLink™**" function requires the use of a compatible smartphone and applications.



When connecting a smartphone to the system, it is recommended that Bluetooth® be started on the smartphone



Connect a USB cable. The smartphone charges when connected by a USB cable.



From the system, press on "**Connectivity**" to display the primary page.



Press "**MirrorLink™**" to start the application in the system.

Depending on the smartphone, it may be necessary to activate the "**MirrorLink™**" function.

OK





During the procedure, several screen pages relating to certain functions are displayed. Accept to start and end the connection.

Once connection is established, a page is displayed with the applications already downloaded to your smartphone and adapted to MirrorLink™ technology.

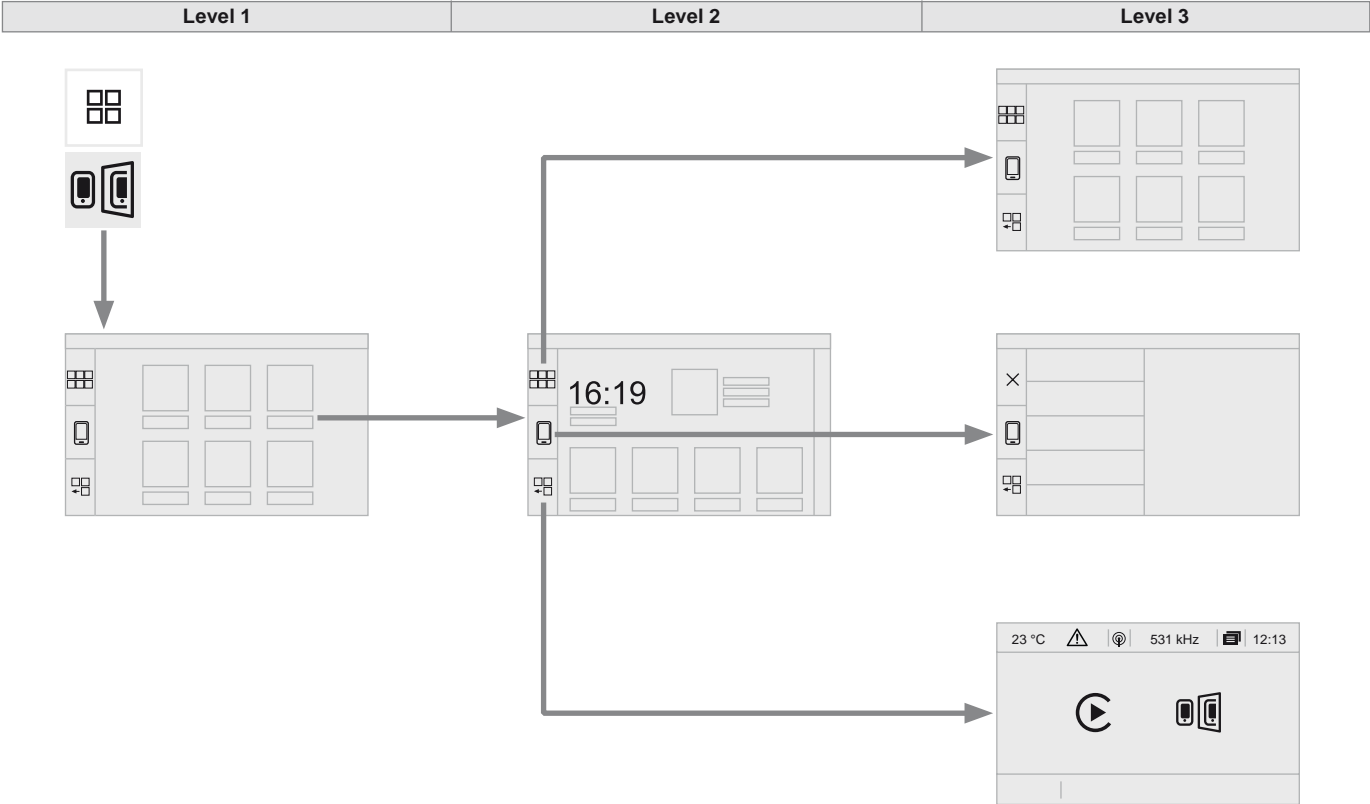
Access to the different audio sources remains accessible in the margin of the MirrorLink™ display, using touch buttons in the upper bar. Access to the menus for the system is possible at any time using the dedicated buttons

i There may be a wait for the availability of applications, depending on the quality of your network.



| Level 1 | | Level 2 | | Level 3 | | Comments |
|--|---|---------|--|---|--|---|
|   | <p>Connectivity</p> <p>↓</p> <p>MirrorLink™</p> | | |  | | Go to or return to the applications already downloaded to your smartphone and adapted to MirrorLink™ technology. |
| | | | |  | | Go to a menu list depending on the application chosen. "Back": abandon the current operation, go up one level. "Home": go to or return to the "Car mode" page on your smartphone. |
| | | | |  | | Go to the primary page of the "Connectivity" menu. |

CarPlay® smartphone connection

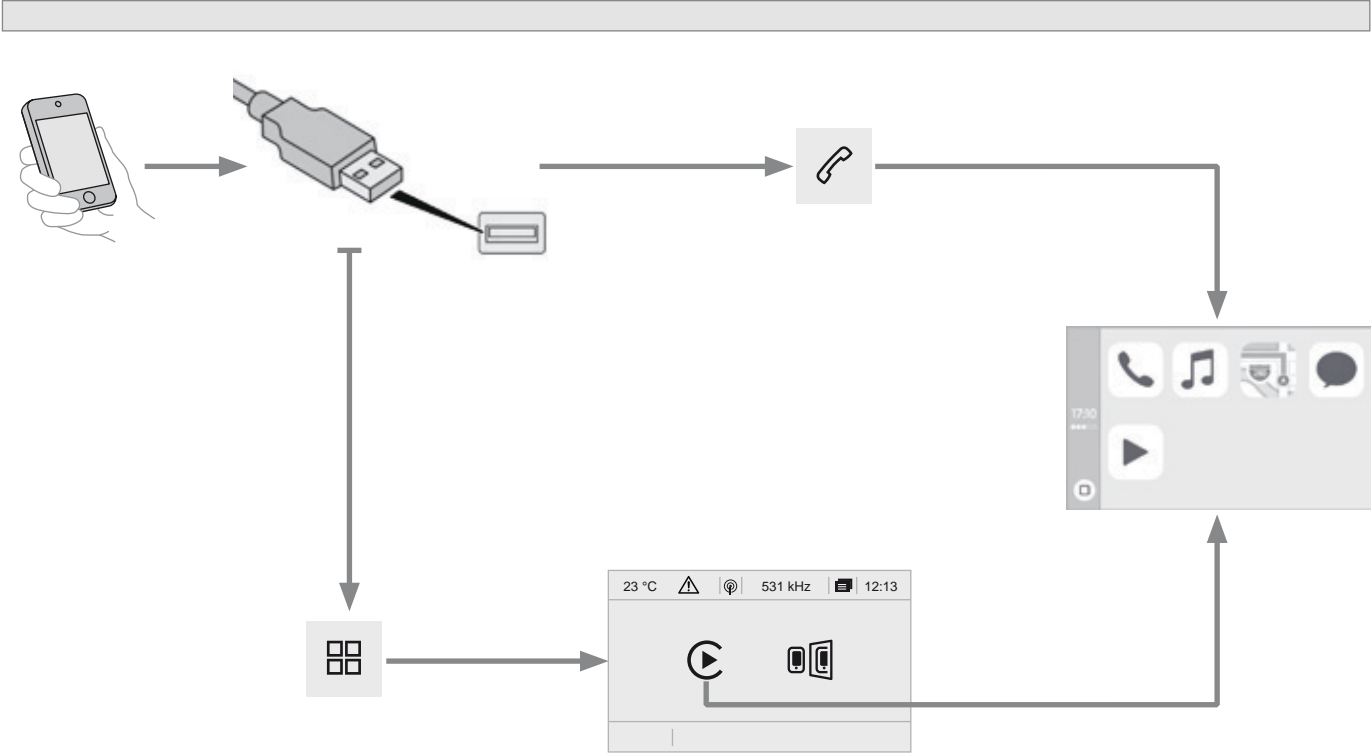

! As a safety measure and because it requires the sustained attention of the driver, using a smartphone when driving is prohibited. Operation must be with the **vehicle stationary**.

i The synchronisation of a smartphone allows applications on a smartphone that are adapted to the CarPlay® technology to be displayed in the vehicle's screen, having first activated the CarPlay® function in your smartphone. As the principles and standards are constantly changing, **it is recommended that you keep your smartphone's operating system updated**. For the list of eligible smartphones, go to the brand's internet website in your country.



Connect a USB cable. The smartphone charges when connected by a USB cable.



Press "**Telephone**" to display the CarPlay® interface.

Or



Connect a USB cable. The smartphone charges when connected by a USB cable.



In the system, press "**Connectivity**" to display the primary page.









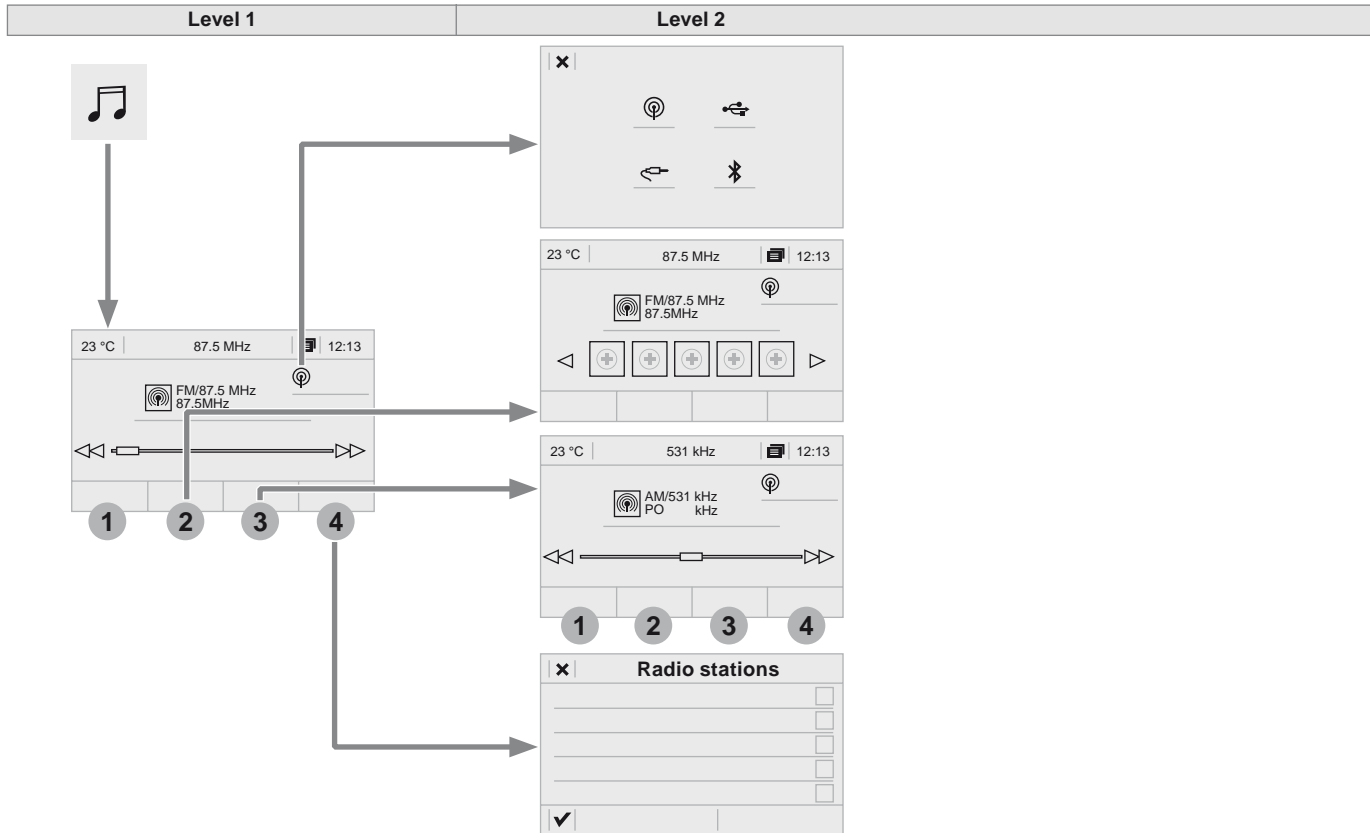



Press "**CarPlay**" to display the CarPlay® interface.







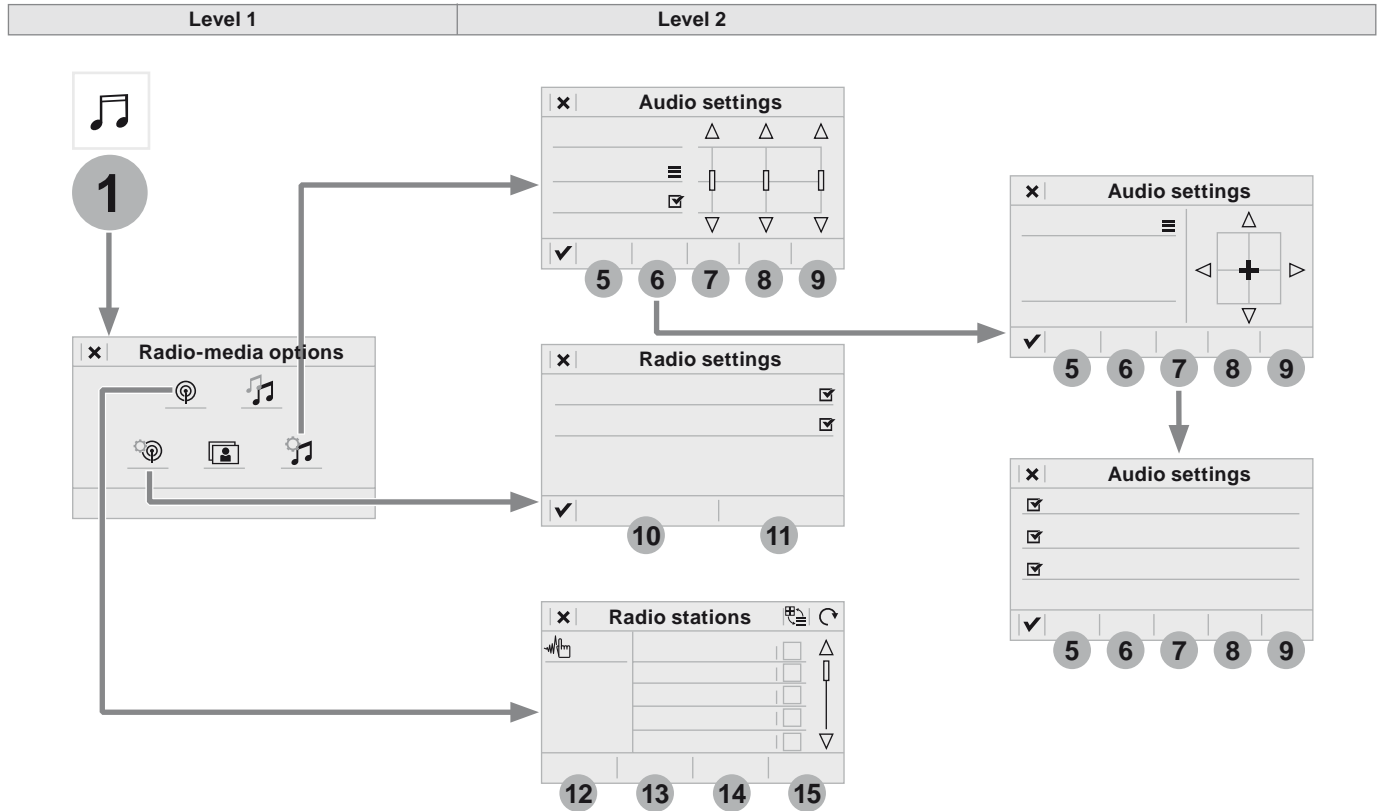

i On connecting the USB cable, the CarPlay® function deactivates the system's Bluetooth® mode.

Radio Media







| Level 1 | | Level 2 | | Comments |
|--|---|--|--|--|
|   | Radio Media ↓ Source |  Radio | | Select change of source. |
| | |  USB | | |
| | |  iPod | | |
| | |  AUX | | |
|  2 | Radio Media ↓ Frequency / Presets | Frequency |  Presets | Carry out an automatic or manual search for radio stations. |
| | | | | Make a long press on an empty location to preset a station. |
|  3 | Radio Media ↓ Band | FM | | Press Band to change waveband. |
| | | DAB | | |
| | | AM | | |
|  4 | Radio Media ↓ List | Radio stations | | Open the list of radio stations and press on a radio station to select it. |

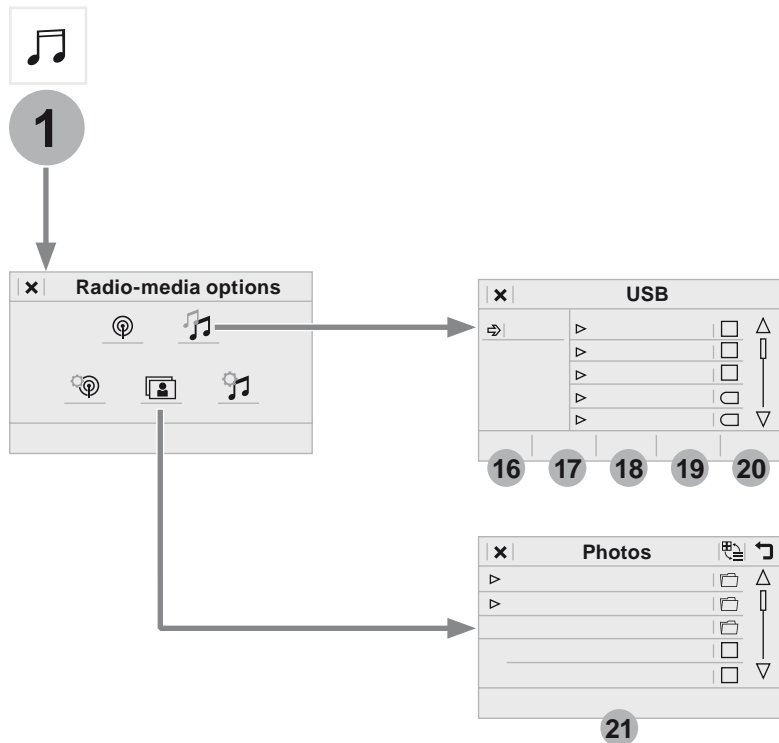

| Level 1 | | Level 2 | | Comments |
|--|---|---|---------------|---|
|  1  | Radio Media ↓ Secondary page ↓ Audio settings | 5 | Ambience | Select the sound ambience. |
| | | 6 | Distribution | Sound distribution by the Arkamys® system. |
| | | 7 | Sound | Adjust the volume or activate volume linked to speed. |
| | | 8 | Voice | Adjust the voice volume. |
| | | 9 | Ringtone | Adjust the ringtone volume. |
| | | ✓ | Confirm | Save settings. |
|  1  | Radio Media ↓ Secondary page ↓ Radio settings | 10 | General | Activate or deactivate settings. |
| | | 11 | Announcements | |
| | | ✓ | Confirm | Save settings. |
|  1  | Radio Media ↓ Secondary page ↓ Radio stations | 12 | FM | Display the list of radio stations for the band selected. |
| | | 13 | DAB | |
| | | 14 | AM | |
| | | 15 | Presets | Select a preset radio station. |
| | |  | Frequency | Enter a frequency manually. |
| | |  | | Change the screen display mode. |
| | |  | | Update the list according to reception. |

Level 1 | Level 2



| Level 1 | | Level 2 | | Comments |
|--|--|-----------|-----------|--|
|  1  | Radio Media ↓ Secondary page ↓ Music files | 16 | Albums | Choose a selection mode. |
| | | 17 | Artists | |
| | | 18 | Genres | |
| | | 19 | Playlists | |
| | | 20 | Folders | |
|  1  | Radio Media ↓ Secondary page ↓ Managing photos | 21 | USB | Display photos. The system supports the following image formats: .gif, .jpg, .jpeg, .bmp, .png, .raw and .tiff with a maximum file size of 10 Mb per image. |

Radio

Selecting a station



Press **Radio Media** to display the menu.



Press "**Frequency**".



Press one of the buttons for an automatic search for radio stations.

Or



Move the cursor for a manual search for frequencies up or down.

Or



Press **Radio Media** to display the primary page.



Press the "**OPTIONS**" button to go to the secondary page.



Select "**Radio stations**" in the secondary page.



Press "**Frequency**".



Enter the values using the virtual keypad.
First enter the units then click on the decimals zone to enter the figures after the decimal point.



Press "**Confirm**".



Radio reception may be affected by the use of electrical equipment not approved by the brand, such as a USB charger connected to the 12 V socket. The exterior environment (hills, buildings, tunnel, car park, below ground...) may prevent reception, even in RDS station tracking mode. This phenomenon is normal in the propagation of radio waves and is in no way indicative of a fault with the audio system.

Preset a station

Select a radio station or frequency (refer to the corresponding section).



Press "**Presets**".



Make a long press on one of the buttons to preset the station.

Activate/ Deactivate RDS



Press **Radio Media** to display the primary page.

1

Press the "**OPTIONS**" button to go to the secondary page.



Select "**Radio settings**".

10

Select "**General**".



Activate/deactivate "**Station follow**".



Press "**Confirm**".

i RDS, if activated, allows you to continue listening to the same station by automatic retuning to alternative frequencies. However, in certain conditions, coverage of an RDS station may not be assured throughout the entire country as radio stations do not cover 100 % of the territory. This explains the loss of reception of the station during a journey.

Display text information



The "radiotext" function allows information transmitted by the radio station and related to the station or the song playing to be displayed.



Press **Radio Media** to display the primary page.

1

Press the "**OPTIONS**" button to go to the secondary page.



Select "**Radio settings**".

10

Select "**General**".



Activate / Deactivate "**Display radio text**".



Press "**Confirm**".

Play TA messages



The TA (Traffic Announcement) function gives priority to TA alert messages. To operate, this function needs good reception of a radio station that carries this type of message. While traffic information is being broadcast, the current media is automatically interrupted so that the TA message can be heard. Normal play of the media previously playing is resumed at the end of the message.

11

Select "**Announcements**".



Activate / Deactivate "**Traffic announcement**".



Press "**Confirm**".

DAB radio (Digital Audio Broadcasting) Terrestrial Digital Radio

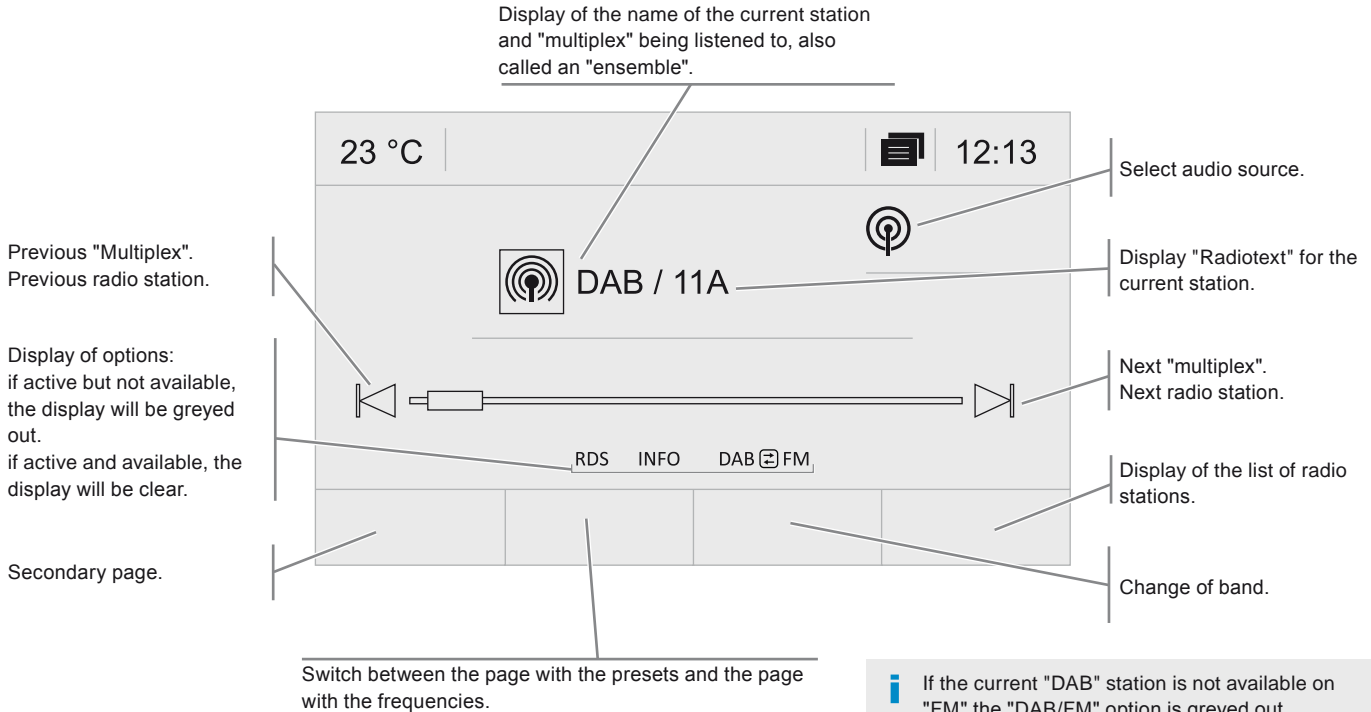

Digital radio

! Digital radio provides higher quality reception.
The different multiplexes offer a choice of radio stations arranged in alphabetical order.



Press **Radio Media** to display the primary page.



Select the audio source.

3

Press "**Band**" to select the "**DAB**" waveband.

DAB / FM auto tracking

i "DAB" does not cover 100% of the territory.
When the digital radio signal is poor, "DAB/FM auto tracking" allows you to continue listening to the same station, by automatically switching to the corresponding "FM" analogue station (if there is one).



Press **Radio Media** to display the primary page.

1

Press the "**OPTIONS**" button to go to the secondary page.



Select "**Radio settings**".

10

Select "**General**".



Activate / Deactivate "**Station follow**".



Press "**Confirm**".

i If "DAB / FM auto tracking" is activated, there is a difference of a few seconds when the system switches to "FM" analogue radio with sometimes a variation in volume.
Once the digital signal is restored, the system automatically changes back to "DAB".

! If the "DAB" station being listened to is not available on "FM" ("**DAB/FM**" option greyed out), or "DAB/FM auto tracking" is not activated, the sound will cut out while the digital signal is too weak.

Media

USB player

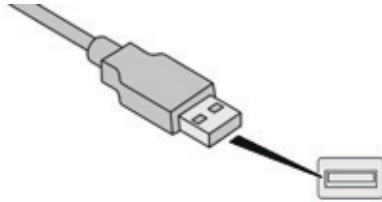

Insert the USB memory stick into the USB port or connect the USB device to the USB port using a suitable cable (not supplied).

The system builds playlists (in temporary memory), an operation which can take from a few seconds to several minutes at the first connection.

Reduce the number of non-music files and the number of folders to reduce the waiting time.

The playlists are updated every time the ignition is switched off or connection of a USB memory stick. The lists are memorised: if they are not modified, the subsequent loading time will be shorter.

Auxiliary (AUX) socket



This source is only available if "Auxiliary input" has been checked in the audio settings.

Connect the portable device (MP3 player...) to the auxiliary Jack socket using an audio cable (not supplied).

First adjust the volume of your portable device (to a high level). Then adjust the volume of your audio system.

Display and management of the controls are via the portable device.

Selecting the source



Press **Radio Media** to display the primary page.



Select "**Source**".

Choose the source.

Bluetooth® audio streaming

Streaming allows you to listen to music from your telephone.

The Bluetooth profile must be activated. First adjust the volume on your portable device (to a high level).

Then adjust the volume of your audio system.

If play does not start automatically, it may be necessary to start the audio playback from the telephone.

Control is from the portable device or by using the audio system buttons.



Once connected in streaming mode, the telephone is considered to be a media source.

Connecting Apple® players

Connect the Apple® player to the USB port using a suitable cable (not supplied). Play starts automatically.

Control is via the audio system.

i The classifications available are those of the portable device connected (artists / albums / genres / playlists / audiobooks / podcasts). The default classification used is by artist. To modify the classification used, return to the first level of the menu then select the desired classification (playlists for example) and confirm to go down through the menu to the desired track.

The version of software in the audio system may not be compatible with the generation of your Apple® player.

Information and advice

The audio equipment will only play audio files with ".wma, .aac, .flac, .ogg and .mp3" file extensions and with a bit rate of between 32 Kbps and 320 Kbps.

It also supports VBR (Variable Bit Rate) mode. No other type of file (.mp4, ...) can be played. ".wma" files must be of the standard wma 9 type. The sampling rates supported are 32, 44 and 48 KHz.

It is advisable to restrict file names to 20 characters, without using of special characters (e.g.: " " ? ; ù) to avoid any playing and displaying problems.





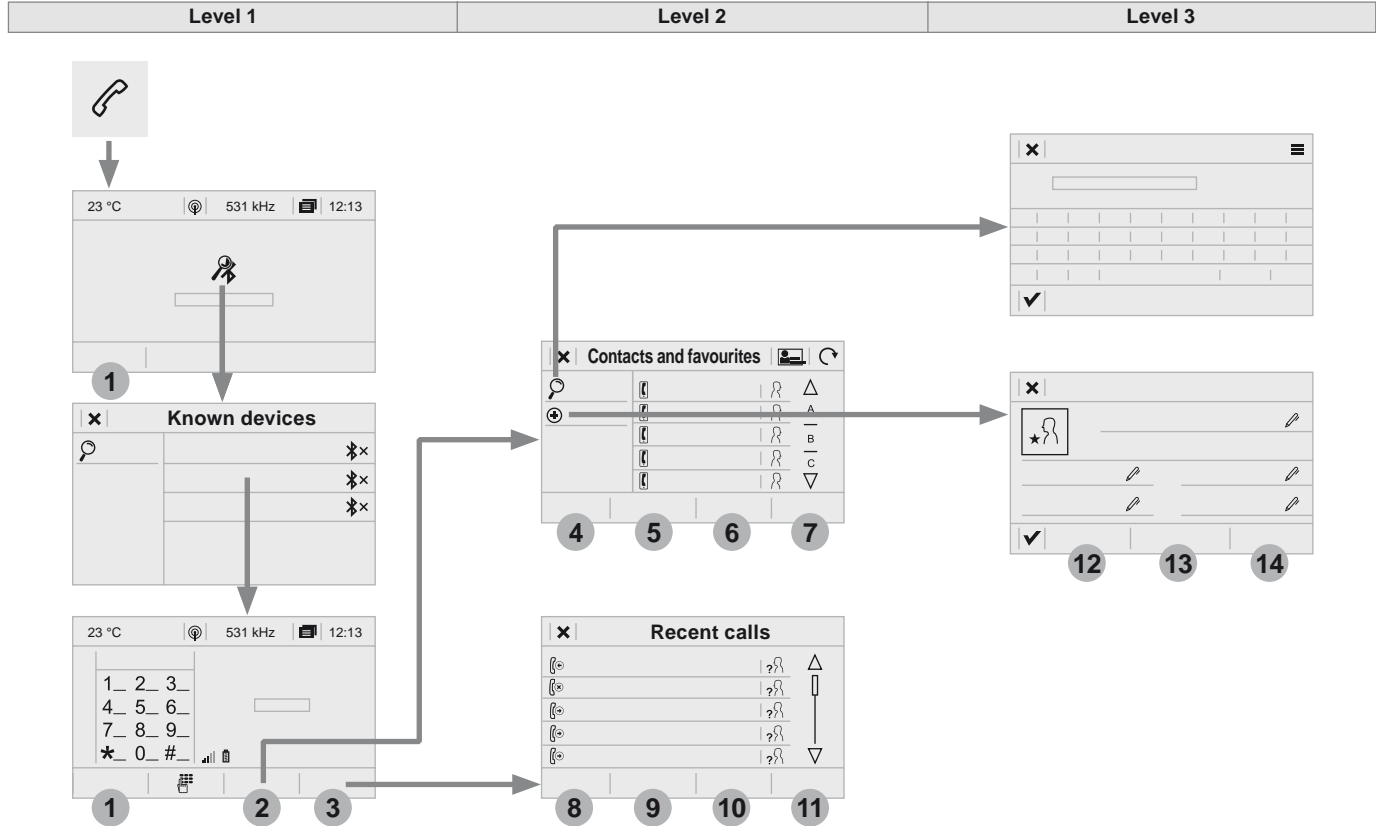

! The system supports USB mass storage devices, BlackBerry® devices or Apple® players via USB ports. The adaptor cable is not supplied. Control of the peripheral device is with the audio system controls. Other peripherals, not recognised on connection, must be connected to the auxiliary socket using a Jack cable (not supplied) or via Bluetooth streaming, depending on compatibility.

Use only USB memory sticks formatted FAT 32 (file allocation table).





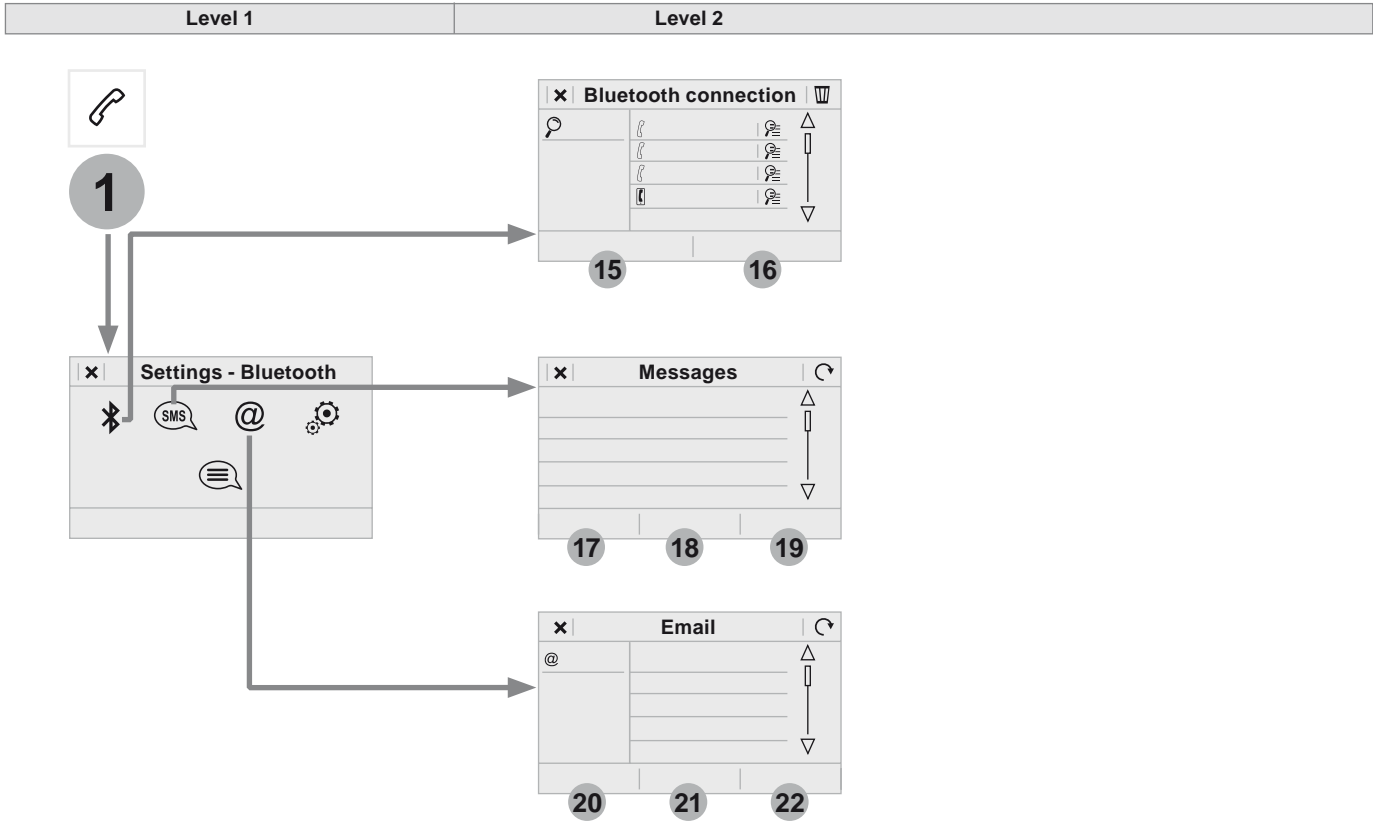

i It is recommended that the USB cable for the portable device is used.

Telephone







| Level 1 | | Level 2 | | Level 3 | | Comments | |
|---|---|---------------|---|---------------|-------------------------------------|--|--|
|  2 | Telephone ↓ Bluetooth ↓ Contact | 4 | All | | | View contacts according to presentation choices. Select a contact or a favourite saved in the system via the profile selected to start the call. | |
| | | 5 | Telephone | | | | |
| | | 6 | Address | | | | |
| | | 7 | Favourites | | | | |
| | | |  | | | | Sort the contacts by Surname-First name or First name-Surname. |
| | | |  | | | | Update the contacts from the telephone. |
| | | |  | Search | <input checked="" type="checkbox"/> | Confirm | Search for a contact in the directory. |
| |  | Create | 12 | Telephone | Create a new contact in the system. | | |
| | | | 13 | Address | | | |
| | | | 14 | Email | | | |
| | | | <input checked="" type="checkbox"/> | Confirm | | | |
|  3 | Telephone ↓ Bluetooth ↓ Calls | 8 | All | | | View calls according to choice of presentation. Select a contact to start the call. | |
| | | 9 | Incoming | | | | |
| | | 10 | Outgoing | | | | |
| | | 11 | Missed | | | | |
| | | |  | | | | View details for the contact. |

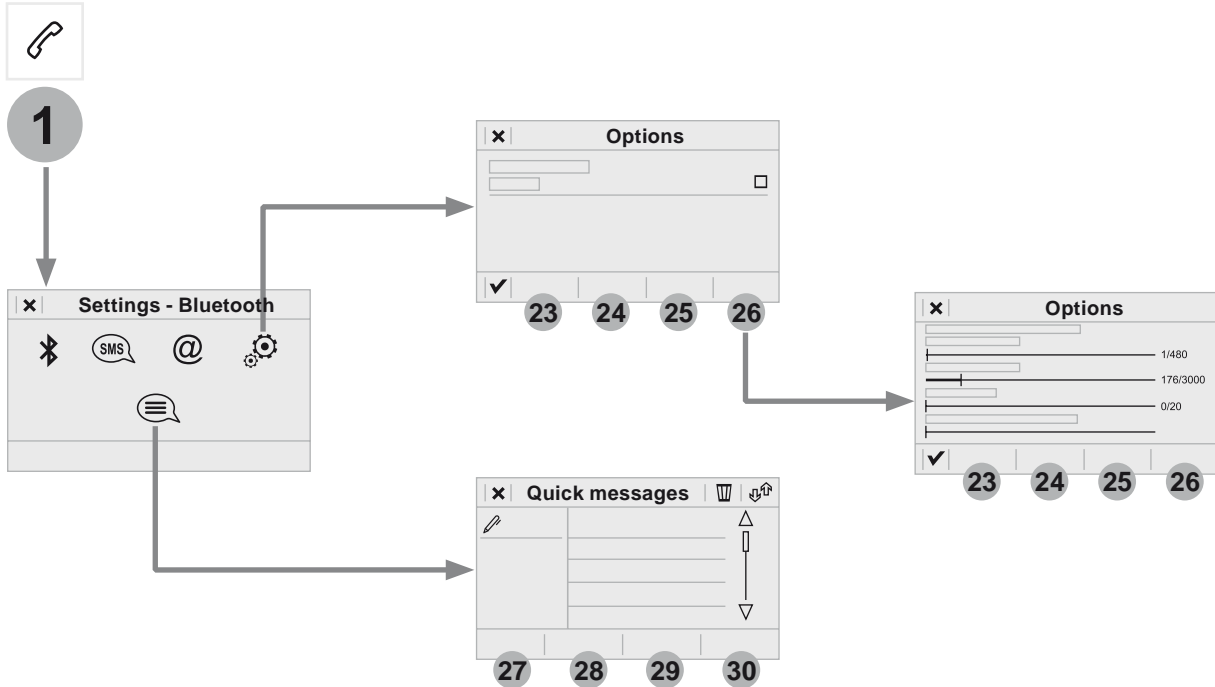

| Level 1 | | Level 2 | | Comments |
|--|---|---|-----------|--|
|  1 | Telephone ↓ Secondary page ↓ Bluetooth connection | 15 | All | Display all telephones, connected or disconnected, recognised by the system. Display all connected telephones. Start the search for a device to connect. |
| | | 16 | Connected | |
| | |  | Search | |
|  1  | Telephone ↓ Secondary page ↓ Messages | 17 | All | Display messages according to the choice made. |
| | | 18 | Received | |
| | | 19 | Sent | |
|  1  | Telephone ↓ Secondary page ↓ Email | 20 | Received | Display emails according to the choice made. |
| | | 21 | Sent | |
| | | 22 | Not read | |
| | | @ | Mailbox | |



| Level 1 | | Level 2 | | Comments |
|--|--|---|---------------|--|
|  1  | <p style="text-align: center;">Telephone ↓ Secondary page ↓ Options</p> | 23 | Security | Make driving safe. |
| | | 24 | Voicemail | Enter and save the number for the telephone voicemail. |
| | | 25 | Ringtone | Adjust the ringtone volume. |
| | | 26 | Statistics | Display data for the telephone connected. |
| | | ✓ | Confirm | Save the options. |
|  1  | <p style="text-align: center;">Telephone ↓ Secondary page ↓ Quick messages</p> | 27 | Delayed | Select a quick message from the categories, as required. |
| | | 28 | My arrival | |
| | | 29 | Not available | |
| | | 30 | Other | |
| | |  | Create | Create a quick message. |

Pairing a Bluetooth® telephone

! As a safety measure and because it requires sustained attention by the driver, the pairing of a Bluetooth mobile telephone with the Bluetooth hands-free system of your audio system must be done with the **vehicle stationary** and the ignition on.

i Activate the Bluetooth function on the telephone and ensure that it is "visible to all" (telephone configuration).

Procedure from the telephone

 Select the system name in the list of devices detected.

In the system, accept the connection request from the telephone.

! To complete the pairing, whichever procedure used (from the telephone or from the system), ensure that the code is the same in the system and in the telephone.

Procedure from the system



Press **Telephone** to display the primary page.



Press **Connect telephone**.

Or.



Select **"Search"**.
The list of telephones detected is displayed.

i If the pairing procedure fails, it is recommended that you deactivate and then reactivate the "Bluetooth" function in your telephone.



Select the name of the chosen telephone in the list.

Connection sharing

The system offers to connect the telephone with 3 profiles:

- **Telephone** (hands-free kit, telephone only),
- **Streaming** (wireless play of audio files on the telephone),
- **Mobile internet data**.

i The **"Mobile internet data"** profile must be activated for connected navigation, having first activated sharing of this connection on your smartphone.



Select one or more profiles.



Press **"Confirm"**.

i Depending on the type of telephone, you may be asked to accept or not the transfer of your contacts and messages.

Automatic reconnection

i On return to the vehicle, if the last telephone connected is present again, it is automatically recognised and within about 30 seconds of switching on the ignition, the connection is established without any action on your part (Bluetooth activated).

To modify the connection profile:



Press **Telephone** to display the primary page.



Press the "**OPTIONS**" button to go to the secondary page.



Select "**Bluetooth connection**" to display the list of paired devices.



Press the "details" button.



Select one or more profiles.



Press on "**Confirm**".



The ability of the system to connect with just one profile depends on the telephone. All three profiles may connect by default.



The services available depend on the network, the SIM card and the compatibility of the Bluetooth devices used. Check in your telephone's manual and with your service provider for the services available to you.



The profiles compatible with the system are HFP, OPP, PBAP, A2DP, AVRCP, MAP and PAN.

Go to the brand's website for more information (compatibility, additional help, ...).

Managing paired telephones

i This function allows the connection or disconnection of a peripheral device as well as the deletion of a pairing.



Press **Telephone** to display the primary page.

1

Press the "**OPTIONS**" button to go to the secondary page.



Select "**Bluetooth connection**" to display the list of paired peripheral devices.



Press on the name of the telephone chosen in the list to disconnect it. Press again to connect it.

Deleting a telephone



Select the basket at top right of the screen to display a basket alongside the telephone chosen.



Press the basket alongside the telephone chosen to delete it.

Receiving a call

An incoming call is announced by a ring and a superimposed display in the screen.

SRC



Make a short press on the steering mounted **TEL** button to accept an incoming call.

And



Make a long press

SRC



on the steering mounted **TEL** button to reject the call.

Or



Select "**End call**".

Making a call

- ! Using the telephone is not recommended while driving. Park the vehicle. Make the call using the steering mounted controls.

Calling a new number



Press **Telephone** to display the primary page.



Enter the phone number using the digital keypad.



Press "**Call**" to start the call.

Calling a contact



Press **Telephone** to display the primary page.



Or make a long press



on the steering mounted **TEL** button.

2

Select "**Contact**".

Select the desired contact from the list offered.



Select "**Call**".

Calling a recently used number



Press **Telephone** to display the primary page.

Or



Make a long press



on the steering mounted button.

3







Select "**Calls**".

Select the desired contact from the list offered.











It is always possible to make a call directly from the telephone; as a safety measure, first park the vehicle.

Managing contacts / entries

-  Press **Telephone** to display the primary page.
-  Select "**Contact**".
-  Select "**Create**" to add a new contact.
-  In the "**Telephone**" tab, enter the telephone numbers for the contact.
-  In the "**Address**" tab, enter the addresses for the contact.
-  In the "**Email**" tab, enter the email addresses for the contact.

i The "**Email**" function allows email addresses to be entered for a contact, but the system is not able to send emails.

Managing messages

-  Press **Telephone** to display the primary page.
-  Press the "**OPTIONS**" button to go to the secondary page.
-  Select "**Messages**" to display the list of messages.
-  Select the "**All**" or "**Received**" or "**Sent**" tab.
-  Select the detail of the message chosen in one of the lists
-  Press "**Answer**" to send a quick message stored in the system.
-  Press "**Call**" to start the call.
-  Press "**Play**" to hear the message.

! The access to "**Messages**" depends on the compatibility of the smartphone and the integral system. Depending on the smartphone, access to your messages or email may be slow.

i The services available depend on the network, the SIM card and the compatibility of the Bluetooth devices used. Check in the manual for your telephone and with your service provider for the services available to you.

Managing quick messages



Press **Telephone** to display the primary page.



Press on the "**OPTIONS**" button to go to the secondary page.



Select "**Messages**" to display the list of messages.



Select the "**Delayed**" or "**My arrival**" or "**Not available**" or "**Other**" tab with the possibility of creating new messages.



Press "**Create**" to write a new message.



Select the message chosen in one of the lists.



Press "**Transfer**" to select the addressee(s).



Press "**Play**" to play the message.



Press this button to "**Modify**" the new quick message(s) created.



The "**Modify**" function does not apply to quick messages already present in the system.

Managing email



Press **Telephone** to display the primary page.



Press the "**OPTIONS**" button to go to the secondary page.



Select "**Email**" to display the list of messages.



Select the "**Received**" or "**Sent**" or "**Not read**" tab.

Select the email chosen in the list.









Press "**Play**" to hear the email.

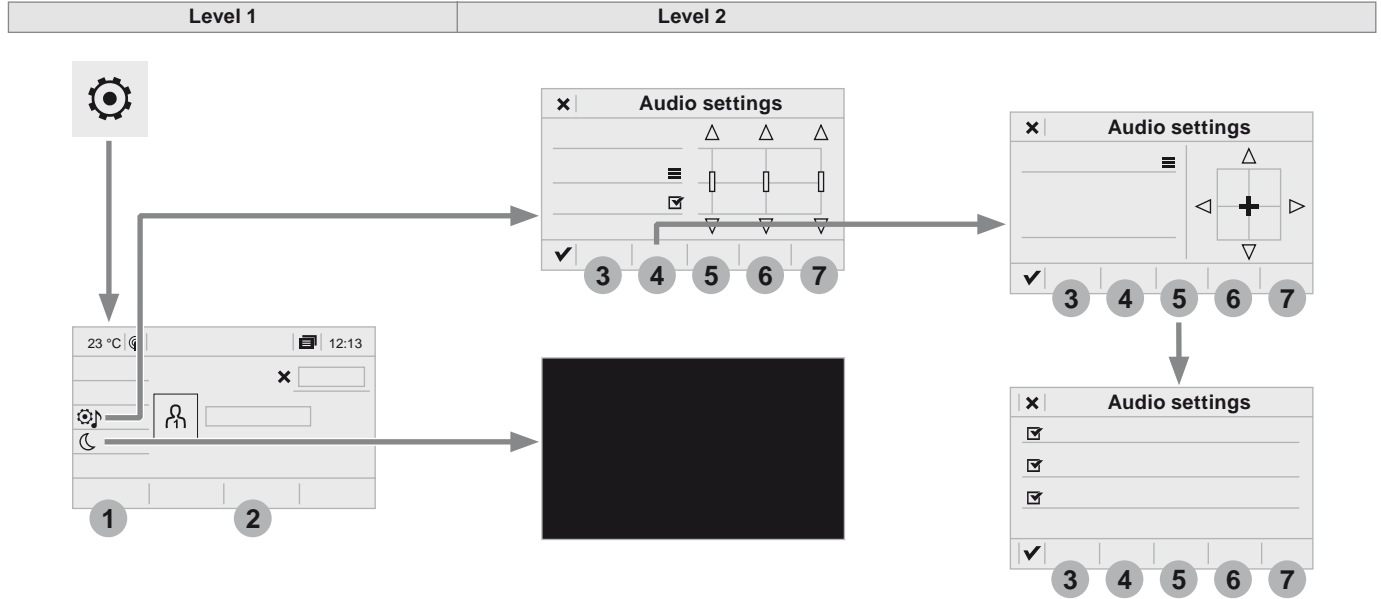









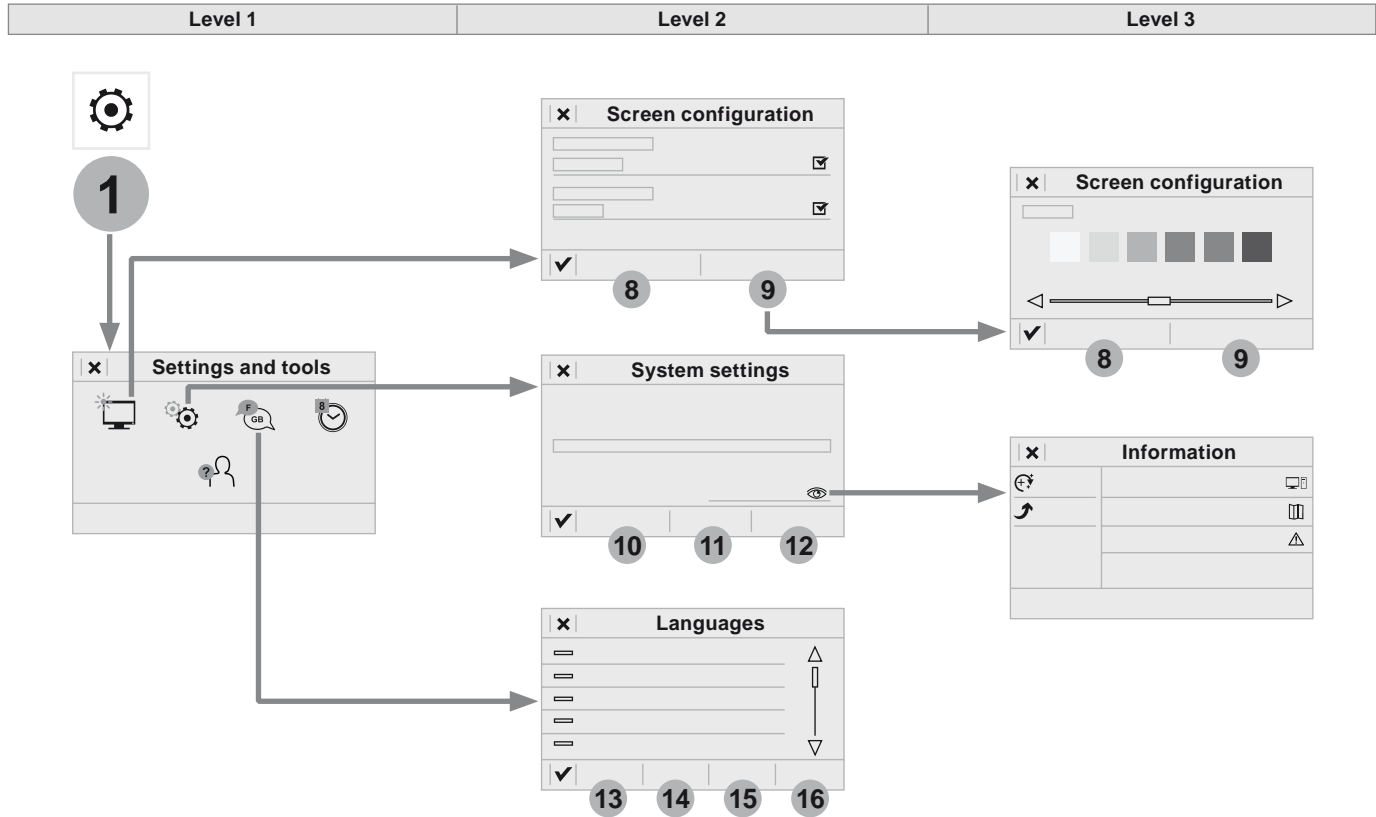



Access to "**Email**" depends on the compatibility of the smartphone and the integral system.



















Settings



| Level 1 | | Level 2 | | Comments |
|--|------------------------------------|---|--------------|---|
|   | Settings ↓ Audio settings | 3 | Ambience | Select the sound ambience. |
| | | 4 | Distribution | Sound distribution by the Arkamys® system. |
| | | 5 | Sound | Adjust the volume or activate volume linked to speed. |
| | | 6 | Voice | Adjust the voice volume. |
| | | 7 | Ringtone | Adjust the ringtone volume. |
| | | ✓ | Confirm | Save the settings. |
|   | Settings ↓ Turn off screen |  | | Function allowing the display to be switched off. Pressing the screen reactivates it. |
|  2 | Settings ↓ Profile (1, 2, 3) | | | Activate the profile selected. |



| Level 1 | | Level 2 | | Level 3 | | Comments |
|---|--|-----------|------------------|---|-------------------------------|--|
|  1 | Settings ↓ Secondary page ↓ Screen configuration | 8 | Animation | <input checked="" type="checkbox"/> | | Activate or deactivate settings. |
| | | 9 | Brightness | | | Adjust the level of brightness. |
| | | ✓ | Confirm | | | Save the settings. |
|  1 | Settings ↓ Secondary page ↓ System settings | 10 | Units |  | Distance and fuel consumption | Set the units used for distance, fuel consumption and temperature. |
| | | | |  | Temperature | |
| | | 11 | Factory settings |  | Reinitialize | Return to the factory settings. |
| | | 12 | System info |  | View | View the versions of the different modules (system, mapping, risk areas) installed in the system as well as the updates available. |
| | | ✓ | Confirm | | | Save the settings. |
|  1 | Settings ↓ Secondary page ↓ Languages | 13 | All |  | | Select the language then confirm. |
| | | 14 | Europe |  | | |
| | | 15 | Asia |  | | |
| | | 16 | America |  | | |
| | | ✓ | Confirm | | | Having selected the language, save the setting. |

| Level 1 | | Level 2 | | Level 3 | | Comments |
|---|--|---|-----------------------|---|--|----------|
|    | Settings ↓ Secondary page ↓ Setting the time-date |  | Date |  Date | Enter the date and select the date format. | |
| | | | |  Date format: | | |
| | |  | Time |  Time | Set the time. | |
| | | | |  Time Zone | Define the time zone. | |
| | | | |  Time format: | Select the time format: 12h / 24h. | |
| | | | |  Synchronisation with GPS (UTC): | Activate or deactivate synchronisation with GPS. | |
| ✓ Confirm | Save the settings. | | | | | |
|    | Settings ↓ Secondary page ↓ Setting of the profiles |  | Profile 1 | | Enter settings for the profiles. | |
| | |  | Profile 2 | | | |
| | |  | Profile 3 | | | |
| | |  | Common profile | | | |
| | | ✓ Confirm | Save the settings. | | | |

Audio settings



Press **Settings** to display the primary page.



Select "**Audio settings**".



Select "**Ambience**".

Or



"**Position**".

Or



"**Sound**".

Or



"**Voice**".

Or



"**Ringtone**".



Press "**Confirm**" to save the settings.

! The sound distribution (or spatialisation with the Arkamys® system) is audio processing that allows the quality of the sound to be adapted according to the number of passengers in the vehicle. Available only with the 6-speaker configuration.

i The audio **Ambience** settings (6 ambiances available) as well as the **Bass**, **Medium** and **Treble** settings are different and independent for each sound source. Activate or Deactivate "**Loudness**".

The settings for "**Position**" (All passengers, Driver and Front only) are common to all sources.

Activate or Deactivate "**Touch tones**", "**Volume linked to speed**" and "**Auxiliary input**".

i On-board audio: Arkamys® Sound Staging optimises the distribution of sound in the passenger compartment.

Profile settings

! As a safety measure and because it requires the sustained attention of the driver, changes to settings must only be done with the **vehicle stationary**.



Press **Settings** to display the primary page.



Press the "**OPTIONS**" button to go to the secondary page.



Select "**Setting of the profiles**".



Select "**Profile 1**", "**Profile 2**", "**Profile 3**" or "**Common profile**".



Press this button to enter a name for the profile using the virtual keypad.



Press "**Confirm**".



Press this button to add a photograph to the profile.



Insert a USB memory stick containing the photograph in the USB port. Select the photograph.



Press "**Confirm**" to accept the transfer of the photograph.



Press "**Confirm**" again to save the settings.

i The location for the photograph is square; the system deforms the original photograph if in another format.

00.0

Press this button to initialise the profile selected.



Initialisation of the profile selected activates the English language by default.

2

Select a "**Profile**" (1 or 2 or 3) to associate the "**Audio settings**" with it.



Select "**Audio settings**".

3

Select "**Ambience**".

Or

4

"**Distribution**".

Or

5

"**Sound**".

Or

6

"**Voice**".

Or

7

"**Ringtone**".



Press "**Confirm**" to save the settings.

Modifying system settings

 Press **Settings** to display the primary page.

1 Press the "**OPTIONS**" button to go to the secondary page.

 Select "**Screen configuration**".

8 Select "**Animation**".

 Activate or deactivate "**Automatic scrolling**".

9 Select "**Brightness**".

 Adjust the brightness of the screen.

 Press **Settings** to display the primary page.

1 Press the "**OPTIONS**" button to go to the secondary page.

 Select "**System settings**".

10 Select "**Units**" to change the units for distance, fuel consumption and temperature.

11 Select "**Factory settings**" to return to the initial settings.

 Returning the system to factory settings activates the English language by default.

12 Select "**System info**" to display the versions of the different modules installed in the system.

Select the language

 Press **Settings** to display the primary page.

1 Press the "**OPTIONS**" button to go to the secondary page.

 Select "**Languages**" to change the language.

Setting the date

 Press **Settings** to display the primary page.

1 Press the "**OPTIONS**" button to go to the secondary page.

 Select "**Setting the time-date**".

17

Select "**Date**".

Press this button to define the date.

Press "**Confirm**".

Select the display format of the date.

i Adjustment of the time and date is only available if synchronisation with GPS is deactivated.
The change between winter and summer time is done by changing the time zone.

Setting the time

Press **Settings** to display the primary page.

1

Press the "**OPTIONS**" button to go to the secondary page.Select "**Setting the time-date**".

18

Select "**Time**".

Press this button to adjust the time using the virtual keypad.

Press "**Confirm**".

Press this button to define the time zone.



Select the display format for the time (12h / 24h).



Activate or deactivate synchronisation with GPS (UTC).

Press "**Confirm**".

i The system does not automatically manage the change between winter and summer time (depending on country).

Frequently asked questions

The following table groups together the answers to the most frequently asked questions concerning your audio system.

Navigation

| QUESTION | ANSWER | SOLUTION |
|---|--|---|
| The route calculation is not successful. | The route settings may conflict with the current location (exclusion of toll roads on a toll motorway). | Check the route settings in the "Navigation" menu. |
| The POIs do not appear. | The POIs have not been selected. | Select the POIs in the list of POIs. |
| The audible warning of "Danger areas" does not work. | The audible warning is not active. | Activate audible warnings (without the possibility of adjusting the volume) in the "Navigation" menu. |
| The system does not suggest a detour around an incident on the route. | The guidance criteria do not take account of TMC messages. | Select a setting for the "Traffic info" function in the list of route settings (Without, Manual or Automatic). |
| I receive a "Danger area" alert which is not on my route. | Other than guidance, the system announces all "Danger areas" positioned in a cone located in front of the vehicle. It may provide an alert for "Danger areas" located on nearby or parallel roads. | Zoom in on the map to view the exact position of the "Danger areas". Select "On the route" to no longer receive alerts other than navigation instructions or to reduce the time for the announcement. |

| QUESTION | ANSWER | SOLUTION |
|--|---|---|
| Certain traffic jams along the route are not indicated in real time. | On starting, it is several minutes before the system starts to receive traffic information. | Wait until the traffic information is being received correctly (display of the traffic information icons on the map). |
| | In certain countries, only major routes (motorways...) are listed for the traffic information. | This phenomenon is normal. The system is dependent on the traffic information available. |
| The altitude is not displayed. | On starting, the initialisation of the GPS may take up to 3 minutes to receive more than 4 satellites correctly. | Wait until the system has started up completely so that there is GPS coverage by at least 4 satellites. |
| | Depending on the geographical environment (tunnel...) or the weather, the conditions of reception of the GPS signal may vary. | This phenomenon is normal. The system is dependent on the GPS signal reception conditions. |

Radio

| QUESTION | ANSWER | SOLUTION |
|---|--|---|
| The quality of reception of the radio station listened to gradually deteriorates or the stored stations do not function (no sound, 87.5 Mhz is displayed...). | The vehicle is too far from the transmitter used by the station listened to or there is no transmitter in the geographical area through which the vehicle is travelling. | Activate the "RDS" function by means of the short-cut menu to enable the system to check whether there is a more powerful transmitter in the geographical area. |
| | The environment (hills, buildings, tunnels, basement car parks...) block reception, including in RDS mode. | This phenomenon is normal and does not indicate a fault with the audio system. |
| | The aerial is absent or has been damaged (for example when going through a car wash or into an underground car park). | Have the aerial checked by a franchised dealer. |
| I cannot find some radio stations in the list of stations received. | The station is not received or its name has changed in the list. | Press on the "Update list" button in the "Radio stations" secondary menu. |
| The name of the radio station changes. | Some radio stations send other information in place of their name (the title of the song for example). | |
| | The system interprets this information as the name of the station. | |

Media

| QUESTION | ANSWER | SOLUTION |
|--|--|--|
| Playback of my USB memory stick starts only after a very long wait (around 2 to 3 minutes). | Some files supplied with the memory stick may greatly slow down access to reading the memory stick (multiplication by 10 of the catalogue time). | Delete the files supplied with the memory stick and limit the number of sub-folders in the file structure on the memory stick. |
| Some characters in the media information are not displayed correctly while playing. | The audio system does not display some types of characters. | Use standard characters to name tracks and folders. |
| Playing of streaming files does not start. | The peripheral device connected does not support automatic play. | Start the playback from the device. |
| The names of tracks and the track length are not displayed on the screen when streaming audio. | The Bluetooth profile does not allow the transfer of this information. | |

Telephone

| QUESTION | ANSWER | SOLUTION |
|---|--|--|
| I cannot connect my Bluetooth telephone. | The telephone's Bluetooth function may be switched off or the telephone may not be visible. | Check that your telephone's Bluetooth function is switched on. Check in the telephone settings that it is "visible to all". |
| | The Bluetooth telephone is not compatible with the system. | You can check the compatibility of your telephone at the brand's website (services). |
| The volume of the telephone connected in Bluetooth mode is inaudible. | The volume depends both on the system and on the telephone. | Increase the volume of the audio system, to maximum if required, and increase the volume of the telephone if necessary. |
| | The ambient noise level has an influence on the quality of telephone communication. | Reduce the ambient noise level (close the windows, reduce the booster fan speed, slow down, ...). |
| Some contacts are duplicated in the list. | The options for synchronizing contacts are synchronizing the contacts on the SIM card, the contacts on the telephone, or both. When both synchronizations are selected, some contacts may be duplicated. | Select "Display SIM card contacts" or "Display telephone contacts". |
| Contacts are not shown in alphabetical order. | Some telephones offer display options. Depending on the settings chosen, contacts can be transferred in a specific order. | Modify the display setting in the telephone directory. |
| The system does not receive SMS text messages. | The Bluetooth mode does not permit sending SMS text messages to the system. | |

Settings

| QUESTION | ANSWER | SOLUTION |
|---|--|--|
| In changing the setting of treble and bass the equalizer setting is deselected. | The selection of an equalizer setting imposes the settings for treble and bass and vice-versa. | Modify the treble and bass or equalizer settings to obtain the desired musical ambience. |
| In changing the equalizer setting, treble and bass return to zero. | | |
| When changing the balance settings, the distribution setting is deselected. | The selection of a distribution setting imposes the balance settings and vice-versa. | Modify the balance or distribution settings to obtain the desired musical ambience. |
| When changing a distribution setting, the balance setting is deselected. | | |

| QUESTION | ANSWER | SOLUTION |
|---|--|---|
| There is a difference in sound quality between the different audio sources. | For optimum sound quality, the audio settings for Loudness, Ambience, Treble, Bass and Volume can be adapted to the different sound sources, which may result in audible differences when changing source. | Check that the audio settings for Loudness, Ambience, Treble, Bass and Volume are adapted to the sources listened to. Adjust the Balance, Treble and Bass to the middle position, select the "None" musical ambience and set the loudness correction to the "Active" position in CD mode or to the "Inactive" position in radio mode. |
| With the engine off, the system switches off after a few minutes of use. | When the engine is switched off, the system's operating time depends on the state of charge of the battery. The switch-off is normal: the system switches to economy mode and switches off to prevent discharging of the vehicle's battery. | Start the vehicle's engine to increase the battery charge. |

CITROËN Connect Radio

Connectivity - Multimedia audio - Bluetooth® telephone



| | Contents |
|----------------------------|----------|
| First steps | 430 |
| Steering mounted controls | 432 |
| Menus | 433 |
| Connectivity | 434 |
| Radio Media | 444 |
| Telephone | 456 |
| Settings | 468 |
| Frequently asked questions | 478 |

i The system is protected in such a way that it will only operate in your vehicle.

i The link below gives access to OSS (Open Source Software) codes for the system.
<http://www.psa-peugeot-citroen.com/oss>

! As a safety measure and because it requires sustained attention by the driver, the pairing of a Bluetooth mobile telephone with the Bluetooth hands-free system of your audio system must be done with the **vehicle stationary** and the ignition on. The display of the energy economy mode message signals that a change to standby is imminent. For more information on the **Energy economy mode** refer to the corresponding section.

First steps



With the engine running, a press mutes the sound.
With the ignition off, a press turns the system on.



Volume.

Use the buttons either side of the touch screen for access to the menus, then press the virtual buttons in the touch screen. All of the touch areas of the screen are white. Each menu is displayed in one or two pages (primary page and secondary page).

! The touch screen is of the "capacitive" type.
To clean the screen, use a soft, non-abrasive cloth (spectacles cloth) with no additional product.
Do not use sharp objects on the screen.
Do not touch the screen with wet hands.

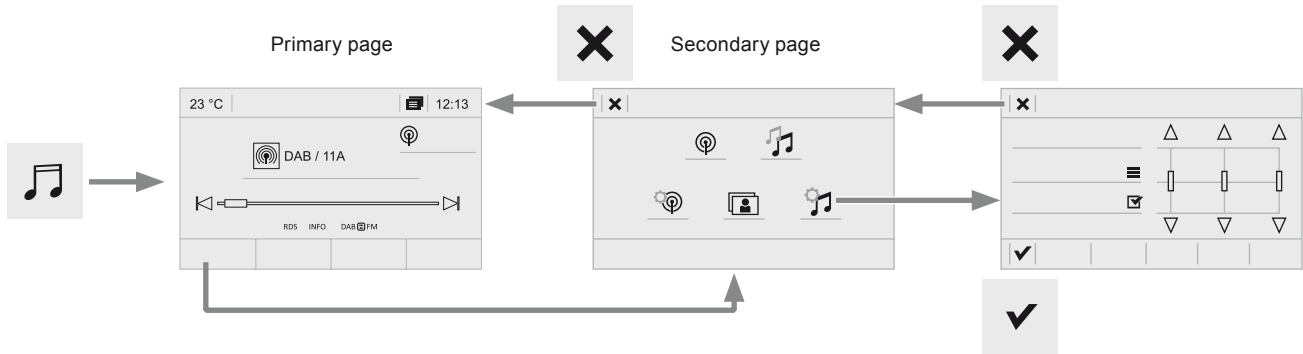

Short-cuts: using the virtual buttons in the upper band of touch screen, it is possible to go directly to the selection of audio source, the list of stations (or titles, depending on the source), message notifications and emails.

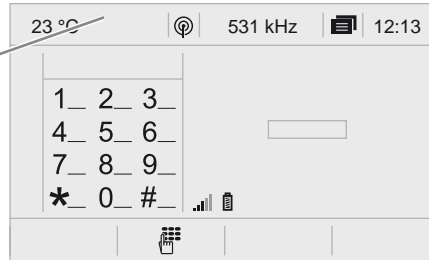
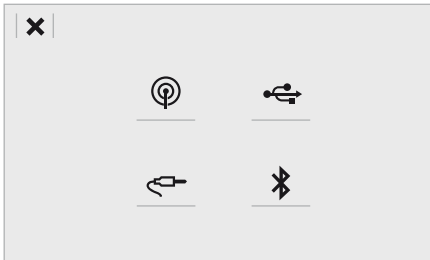

Select the audio source (depending on version):

- FM / DAB* / AM* stations.
- Smartphone via MirrorLink™ or CarPlay®.
- USB memory stick.
- Media player connected to the auxiliary socket (jack, cable not supplied).
- Telephone connected by Bluetooth* and using Bluetooth* audio streaming.

* Depending on equipment.

i In the "Settings" menu you can create a profile for just one person or a group of people with common points, with the possibility of entering a multitude of settings (radio presets, audio settings, contact favourites, ...); these settings are taken into account automatically.

i In very hot conditions, the volume may be limited to protect the system. It may go into standby (screen and sound off) for at least 5 minutes. The return to normal takes place when the temperature in the passenger compartment drops.

Steering mounted controls



Voice commands:

Long press, smartphone voice commands via the system.



Increase volume.



Mute/ Restore the sound.



Decrease volume.



Media (short press): change the multimedia source.

Telephone (short press): call.

Call in progress (short press): access to telephone menu.

Telephone (long press): reject an incoming call, end call, access to telephone menu.



Radio (rotate): automatic search for the previous / next station.

Media (rotate): previous / next track, move in a list.

Short press: Confirm a selection. Other than selection, access to presets.

LIST

Radio: display the list of stations.

Media: display the list of tracks.

Radio, press and hold: update the list of stations received.

Menus

Connectivity

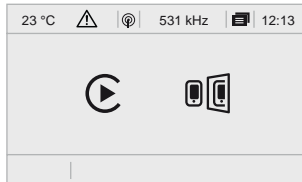

Operate certain applications on a smartphone connected via MirrorLink™ or CarPlay®. Check the state of Bluetooth and Wi-Fi connections.

Settings

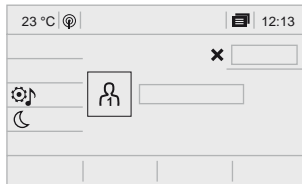

Enter settings for a personal profile and/or adjust the settings for sound (balance, ambience, ...), and the display (language, units, date, time, ...).

Radio Media

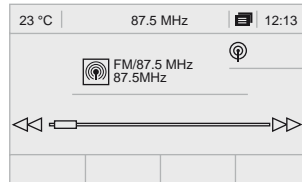

Select an audio source, a radio station, display photographs.

Driving

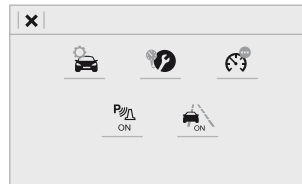

Activate, deactivate, adjust the settings for certain vehicle functions.

Telephone

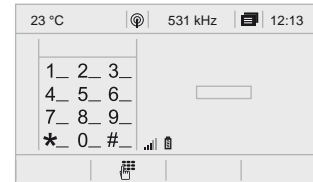







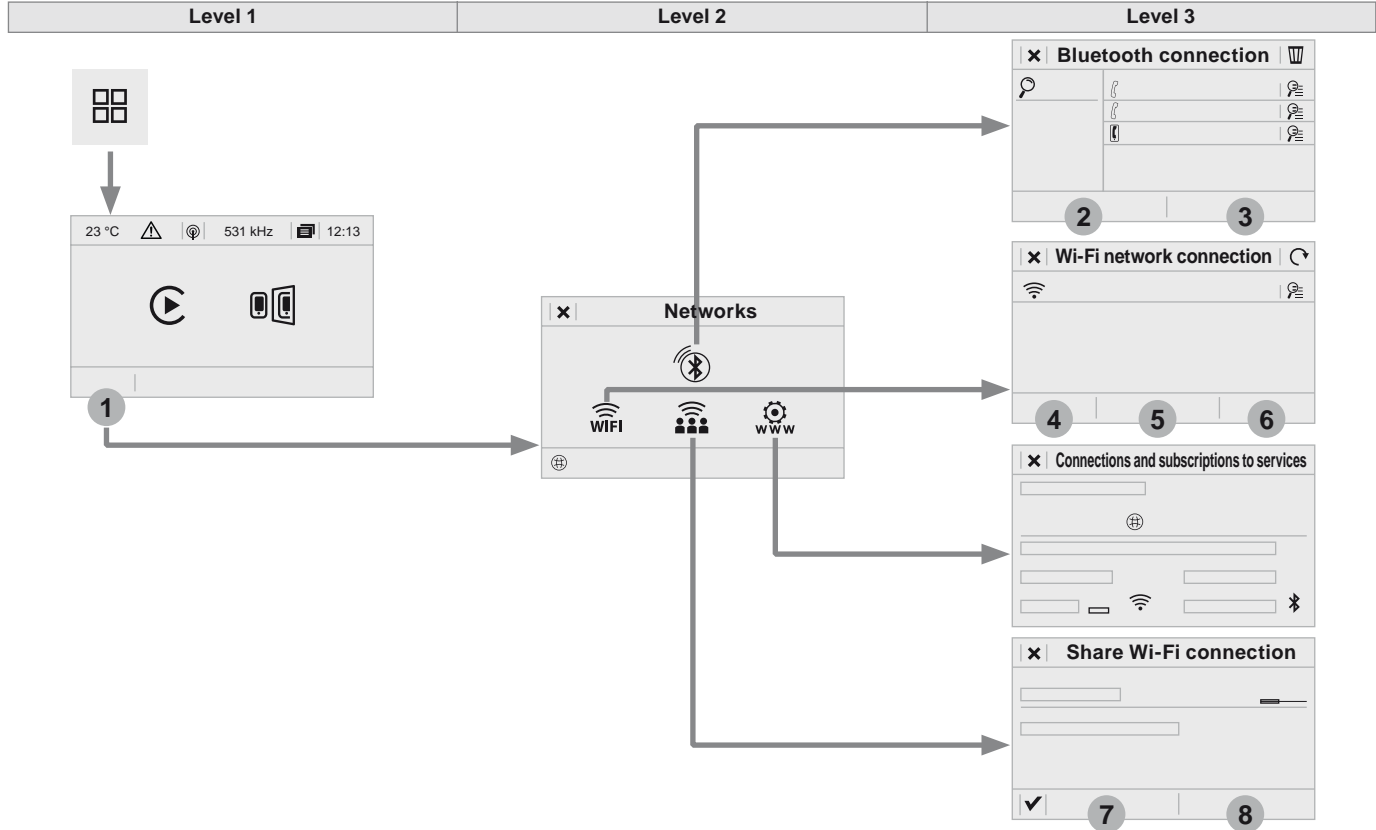

Connect a telephone by Bluetooth®, read messages and emails and send quick messages.

Connectivity

Functionalities available according to equipment.



Functionalities available according to equipment.

| Level 2 | | Level 3 | | Comments |
|--|---|---|-------------|---|
|  1  | Connectivity ↓ Secondary page ↓ Bluetooth connection | 2 | All | Display all telephones, connected or disconnected. |
| | | 3 | Connected | Display all connected telephones. |
| | |  | Search | Start a search for a device to connect. |
|  1  | Connectivity ↓ Secondary page ↓ Wi-Fi network connection | 4 | Secured | Display secured Wi-Fi networks. |
| | | 5 | Not secured | Display non-secured Wi-Fi networks. |
| | | 6 | Stored | Display remembered Wi-Fi networks. |
|  1  | Connectivity ↓ Secondary page ↓ Manage connection | | | Display the state of the subscription to connected services, the state of the network connection and the connection mode. |
|  1  | Connectivity ↓ Secondary page ↓ Share Wi-Fi connection | 7 | Activation | Activate or deactivating the sharing of the Wi-Fi connection. |
| | | 8 | Settings | Select a Wi-Fi network found by the system and connect to it. |
| | | ✓ | | Save settings. |

Bluetooth® connection

! As a safety measure and because it requires sustained attention by the driver, the pairing of a Bluetooth mobile telephone with the Bluetooth hands-free system of your audio system must be done with the **vehicle stationary** and the ignition on.

i Activate the Bluetooth function on the telephone and ensure that it is "visible to all" (telephone configuration).

Procedure from the telephone

 Select the name of the system in the list of devices detected.

In the system, accept the connection request from the telephone.

! To complete the pairing, whichever procedure used (from the telephone or from the system), ensure that the code is the same in the system and in the telephone.

Procedure from the system



Press "**Telephone**" to display the secondary page.

1

Press the "**OPTIONS**" button to go to the secondary page.



Press "**Bluetooth connection**".



Select "**Search**".
The list of detected telephones is displayed.



If the pairing procedure fails, it is recommended that you deactivate and then reactivate the "Bluetooth" function in your telephone.



Select the name of the chosen telephone in the list.



Depending on the type of telephone, you may be asked to accept or not the transfer of your contacts and messages.

Connection sharing

The system offers to connect the telephone with 3 profiles:

- "**Telephone**" (hands-free kit, telephone only),
- "**Streaming**" (wireless play of audio files on the telephone),
- "**Mobile internet data**".



Select one or more profiles.



Press "**Confirm**".

Wi-Fi connection

Network connection by the smartphone Wi-Fi.



Press "**Connectivity**" to display the primary page.

1

Press the "**OPTIONS**" button to go to the secondary page.



Select "**Wi-Fi network connection**".



Select the "**Secured**", "**Not secured**" or "**Stored**" tab.



Select a network.



Using the virtual keypad, enter the "**Key**" for the Wi-Fi network and the "**Password**".



Press "**Confirm**" to start the connection.

i The Wi-Fi connection and the sharing of the Wi-Fi connection are exclusive.

Sharing the Wi-Fi connection

Creation of a local Wi-Fi network by the system.



Press **Connectivity** to display the primary page.

1

Press the "**OPTIONS**" button to go to the secondary page.



Select "**Share Wi-Fi connection**".

7

Select the "**Activation**" tab to activate or deactivate sharing of the Wi-Fi connection.

And / Or

8

Select the "**Settings**" to change the name of the system network and the password.



Press "**Confirm**".

i To protect from any piracy and provide maximum security for your systems, it is recommended that you use a security code or complex password.

Managing connections



Press **Connectivity** to display the primary page.

1

Press the "**OPTIONS**" button to go to the secondary page.



Select "**Manage connection**".

With this function you can view the access to connected services, the availability of connected services and modify the connection mode.

MirrorLink™ smartphone connection

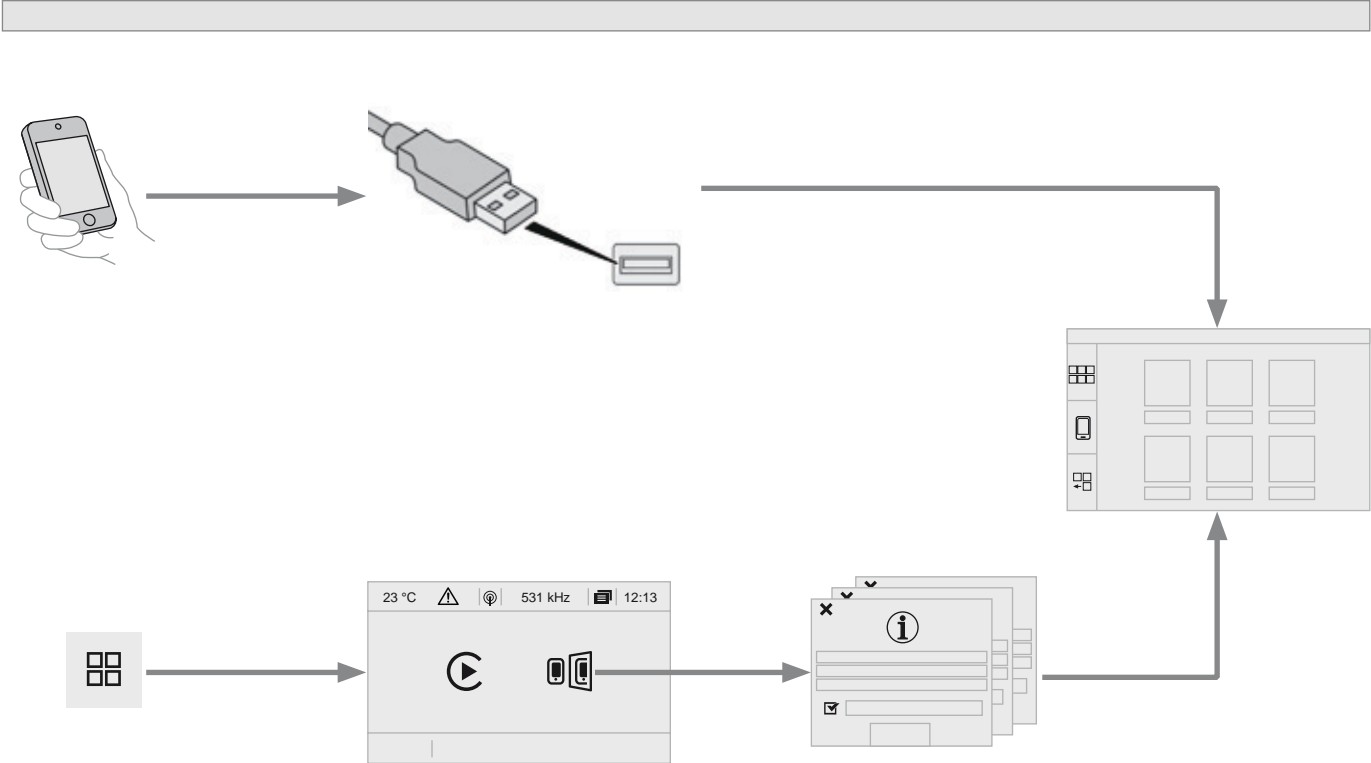

! As a safety measure and because it requires the sustained attention of the driver, using a smartphone when driving is prohibited. Operation must be with the **vehicle stationary**.

i The synchronisation of a smartphone allows applications on a smartphone that are adapted to the MirrorLink™ technology to be displayed in the vehicle's screen. The principles and standards are constantly evolving. For the communication process between the smartphone and the system to work correctly, the smartphone must be unlocked; **update the operating system of your smartphone as well as the date and time in the smartphone and the system**. For the list of eligible smartphones, connect to the brand's internet website in your country.

! As a safety measure, applications can only be viewed with the vehicle stationary; display is interrupted once the vehicle is moving.

i The "**MirrorLink™**" function requires the use of a compatible smartphone and applications.



When connecting a smartphone to the system, it is recommended that Bluetooth® be started on the smartphone.



Connect a USB cable. The smartphone charges when connected by a USB cable.



From the system, press on "**Connectivity**" to display the primary page.



Press "**MirrorLink™**" to start the application in the system.

Depending on the smartphone, it may be necessary to activate the "**MirrorLink™**" function.

OK





During the procedure, several screen pages relating to certain functions are displayed. Accept to start and end the connection.

Once connection is established, a page is displayed with the applications already downloaded to your smartphone and adapted to MirrorLink™ technology.

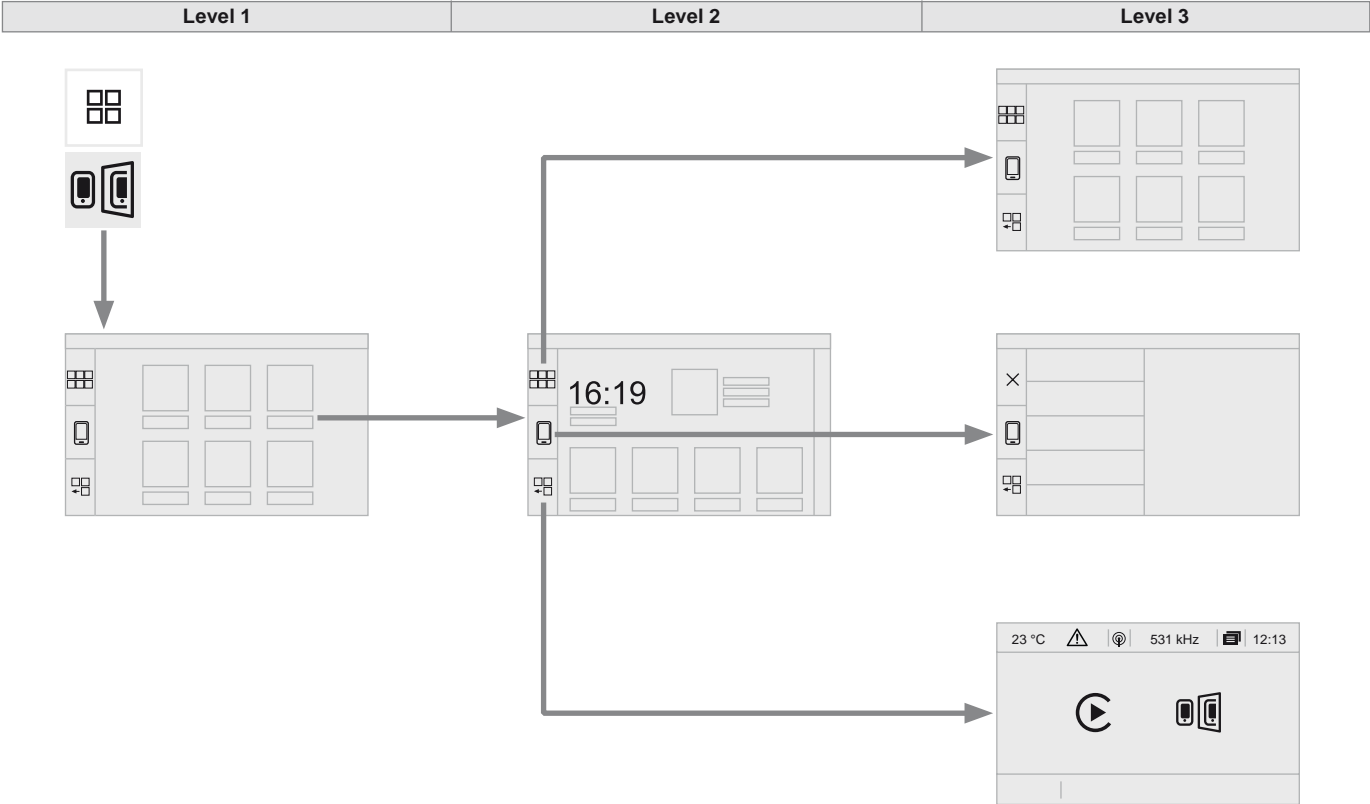
Access to the different audio sources remains accessible in the margin of the MirrorLink™ display, using touch buttons in the upper bar. Access to the menus for the system is possible at any time using the dedicated buttons

i There may be a wait for the availability of applications, depending on the quality of your network.



| Level 1 | | Level 2 | | Level 3 | | Comments |
|--|---|---------|--|---|--|---|
|   | <p>Connectivity</p> <p>↓</p> <p>MirrorLink™</p> | | |  | | Go to or return to the applications already downloaded to your smartphone and adapted to MirrorLink™ technology. |
| | | | |  | | Go to a menu list depending on the application chosen. "Back": abandon the current operation, go up one level. "Home": go to or return to the "Car mode" page on your smartphone. |
| | | | |  | | Go to the primary page of the "Connectivity" menu. |

CarPlay® smartphone connection

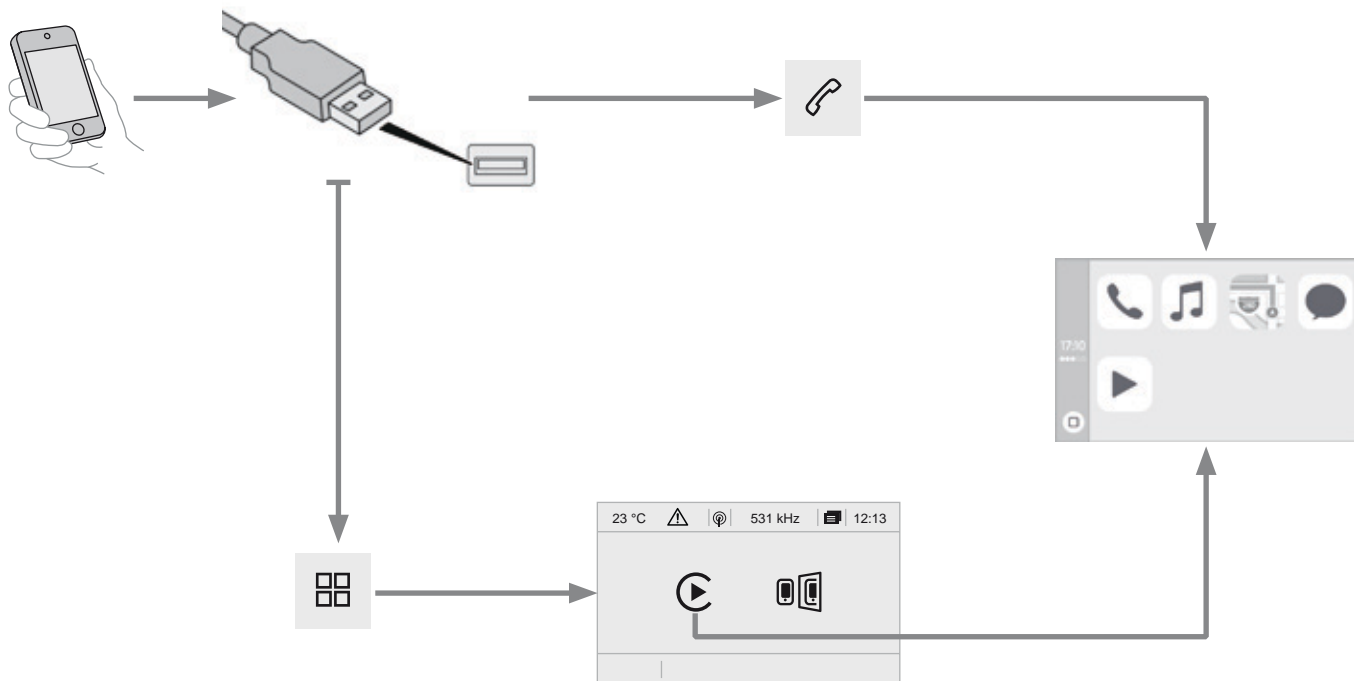

! As a safety measure and because it requires the sustained attention of the driver, using a smartphone when driving is prohibited. Operation must be with the **vehicle stationary**.

i The synchronisation of a smartphone allows applications on a smartphone that are adapted to the CarPlay® technology to be displayed in the vehicle's screen, having first activated the CarPlay® function in your smartphone. As the principles and standards are constantly changing, **it is recommended that you keep your smartphone's operating system updated**. For the list of eligible smartphones, go to the brand's internet website in your country.



Connect a USB cable. The smartphone charges when connected by a USB cable.



Press "**Telephone**" to display the CarPlay® interface.

Or



Connect a USB cable. The smartphone charges when connected by a USB cable.



In the system, press "**Connectivity**" to display the primary page.









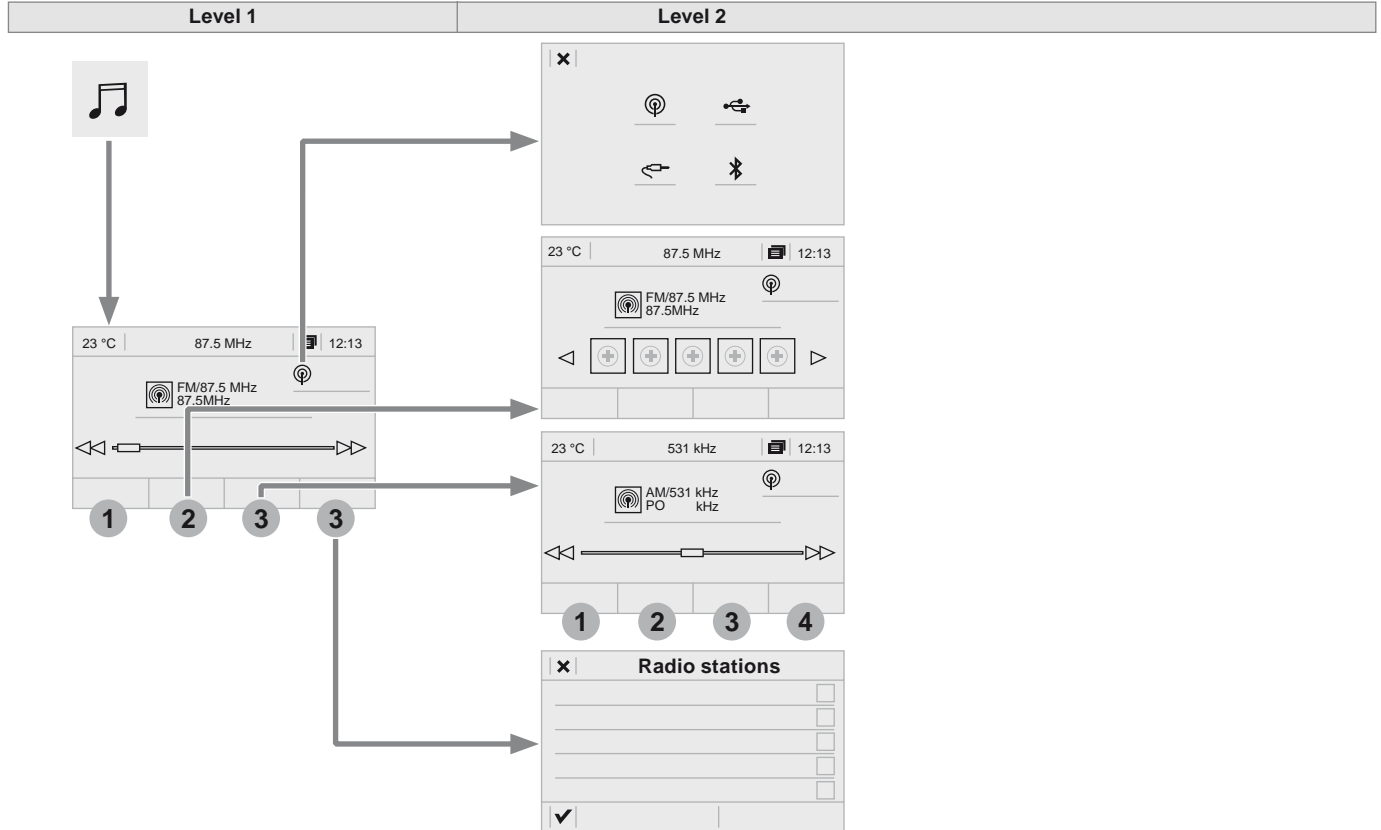



Press "**CarPlay**" to display the CarPlay® interface.







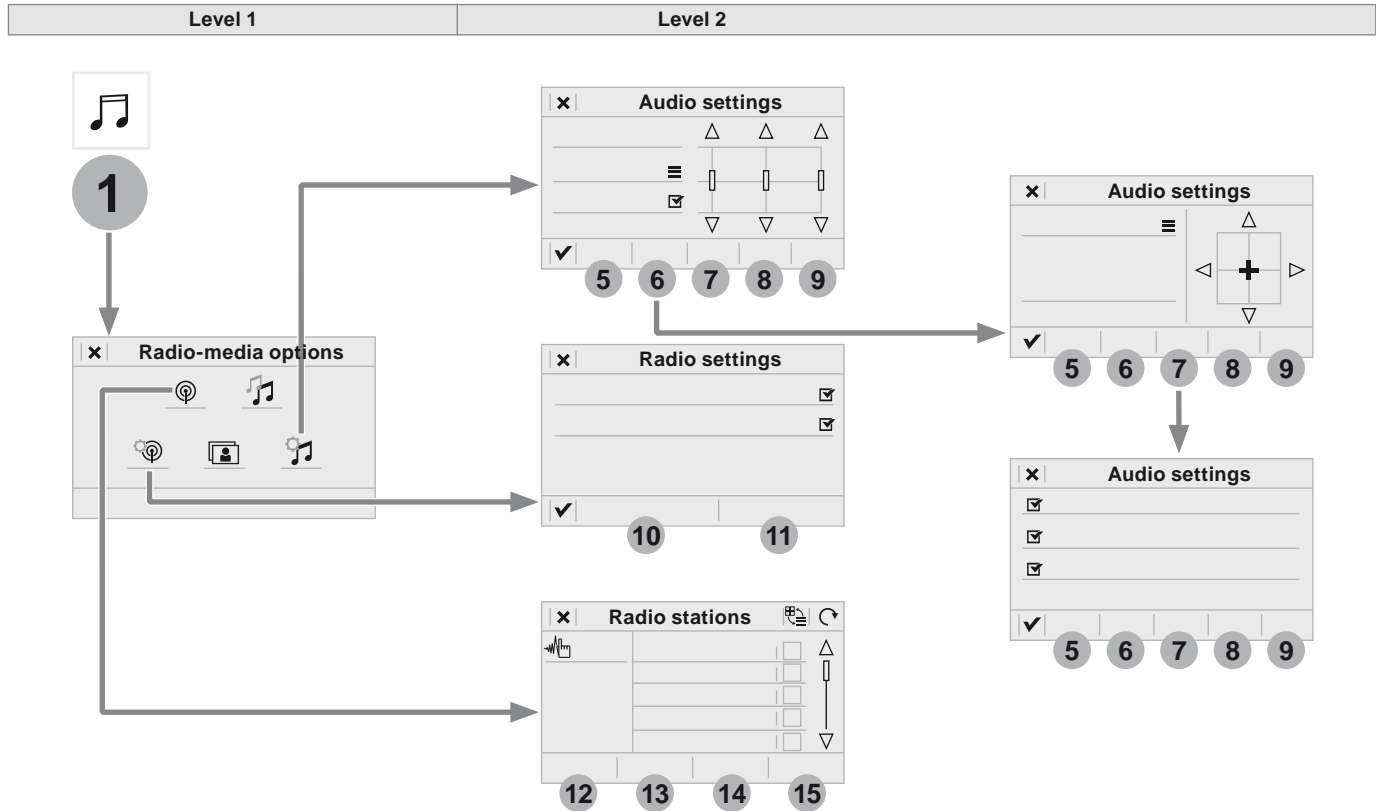

i On connecting the USB cable, the CarPlay® function deactivates the system's Bluetooth® mode.

Radio Media







| Level 1 | | Level 2 | | Comments |
|--|---|--|--|----------|
|   | Radio Media ↓ Source |  Radio | Select change of source. | |
| | |  USB | | |
| | |  iPod | | |
| | |  AUX | | |
|  2 | Radio Media ↓ Frequency / Presets | Frequency | Carry out an automatic or manual search for radio stations. | |
| | |  Presets | Make a long press on an empty location to preset a station. | |
|  3 | Radio Media ↓ Band | FM | Press Band to change waveband. | |
| | | DAB | | |
| | | AM | | |
|  4 | Radio Media ↓ List | Radio stations | Open the list of radio stations and press on a radio station to select it. | |

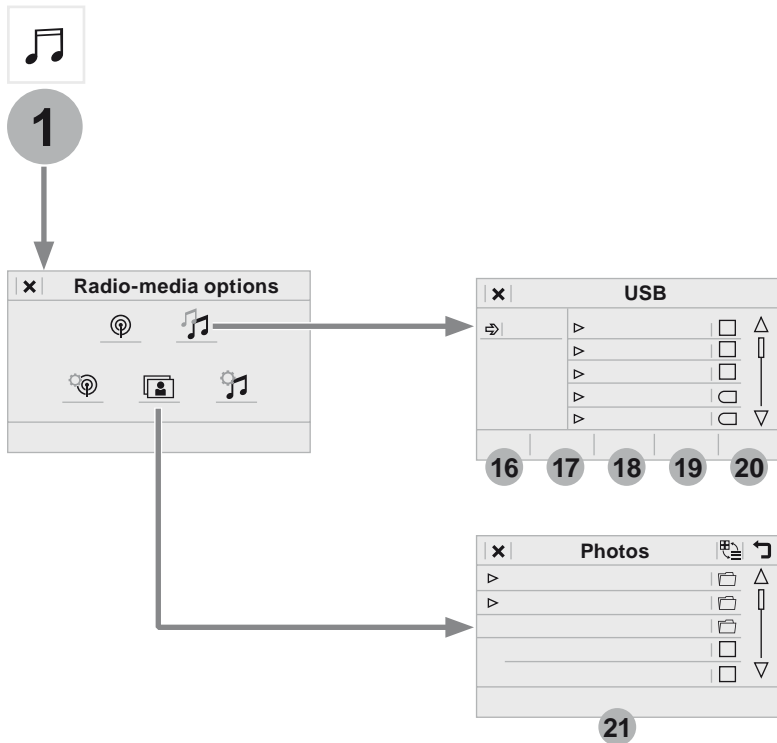

| Level 1 | | Level 2 | | Comments |
|--|---|---|---------------|---|
|  1  | Radio Media ↓ Secondary page ↓ Audio settings | 5 | Ambience | Select the sound ambience. |
| | | 6 | Distribution | Sound distribution by the Arkamys® system. |
| | | 7 | Sound | Adjust the volume or activate volume linked to speed. |
| | | 8 | Voice | Adjust the voice volume. |
| | | 9 | Ringtone | Adjust the ringtone volume. |
| | | ✓ | Confirm | Save settings. |
|  1  | Radio Media ↓ Secondary page ↓ Radio settings | 10 | General | Activate or deactivate settings. |
| | | 11 | Announcements | |
| | | ✓ | Confirm | Save settings. |
|  1  | Radio Media ↓ Secondary page ↓ Radio stations | 12 | FM | Display the list of radio stations for the band selected. |
| | | 13 | DAB | |
| | | 14 | AM | |
| | | 15 | Presets | Select a preset radio station. |
| | |  | Frequency | Enter a frequency manually. |
| | |  | | Change the screen display mode. |
| | |  | | Update the list according to reception. |

Level 1 Level 2



| Level 1 | | Level 2 | | Comments |
|--|---------------------|-----------|-----------|--|
|  1  | Radio Media | 16 | Albums | Choose a selection mode. |
| | ↓ Secondary page | 17 | Artists | |
| | ↓ Music files | 18 | Genres | |
| | | 19 | Playlists | |
| | | 20 | Folders | |
|  1  | Radio Media | 21 | USB | Display photos. The system supports the following image formats: .gif, .jpg, .jpeg, .bmp, .png, .raw and .tiff with a maximum file size of 10 Mb per image. |
| ↓ Secondary page | | | | |
| ↓ Managing photos | | | | |

Radio

Selecting a station



Press **Radio Media** to display the menu.



Press "**Frequency**".



Press one of the buttons for an automatic search for radio stations.

Or



Move the cursor for a manual search for frequencies up or down.

Or



Press **Radio Media** to display the primary page.



Press the "**OPTIONS**" button to go to the secondary page.



Select "**Radio stations**" in the secondary page.



Press "**Frequency**".



Enter the values using the virtual keypad.
First enter the units then click on the decimals zone to enter the figures after the decimal point.



Press "**Confirm**".



Radio reception may be affected by the use of electrical equipment not approved by the brand, such as a USB charger connected to the 12 V socket. The exterior environment (hills, buildings, tunnel, car park, below ground...) may prevent reception, even in RDS station tracking mode. This phenomenon is normal in the propagation of radio waves and is in no way indicative of a fault with the audio system.

Preset a station

Select a radio station or frequency (refer to the corresponding section).



Press "**Presets**".



Make a long press on one of the buttons to preset the station.

Activate/ Deactivate RDS



Press **Radio Media** to display the primary page.

1

Press the "**OPTIONS**" button to go to the secondary page.



Select "**Radio settings**".

10

Select "**General**".



Activate/deactivate "**Station follow**".



Press "**Confirm**".

i RDS, if activated, allows you to continue listening to the same station by automatic retuning to alternative frequencies. However, in certain conditions, coverage of an RDS station may not be assured throughout the entire country as radio stations do not cover 100 % of the territory. This explains the loss of reception of the station during a journey.

Display text information



The "radiotext" function allows information transmitted by the radio station and related to the station or the song playing to be displayed.



Press **Radio Media** to display the primary page.

1

Press the "**OPTIONS**" button to go to the secondary page.



Select "**Radio settings**".

10

Select "**General**".



Activate / Deactivate "**Display radio text**".



Press "**Confirm**".

Play TA messages



The TA (Traffic Announcement) function gives priority to TA alert messages. To operate, this function needs good reception of a radio station that carries this type of message. While traffic information is being broadcast, the current media is automatically interrupted so that the TA message can be heard. Normal play of the media previously playing is resumed at the end of the message.

11

Select "**Announcements**".



Activate / Deactivate "**Traffic announcement**".



Press "**Confirm**".

DAB radio (Digital Audio Broadcasting) Terrestrial Digital Radio

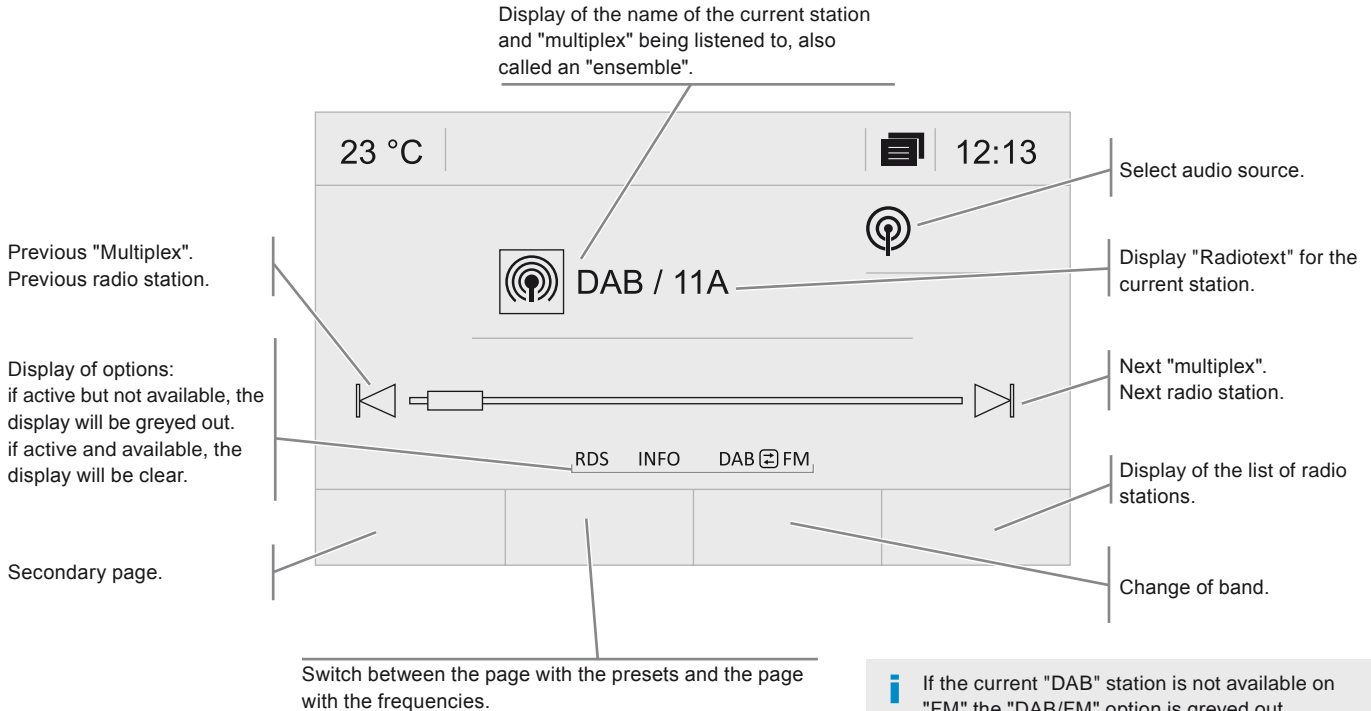

Digital radio

! Digital radio provides higher quality reception.
The different multiplexes offer a choice of radio stations arranged in alphabetical order.



Press **Radio Media** to display the primary page.



Select the audio source.

3

Press "**Band**" to select the "**DAB**" waveband.

DAB / FM auto tracking

i "DAB" does not cover 100% of the territory.
When the digital radio signal is poor, "DAB/FM auto tracking" allows you to continue listening to the same station, by automatically switching to the corresponding "FM" analogue station (if there is one).



Press **Radio Media** to display the primary page.

1

Press the "**OPTIONS**" button to go to the secondary page.



Select "**Radio settings**".

10

Select "**General**".



Activate / Deactivate "**Station follow**".



Press "**Confirm**".

i If "DAB / FM auto tracking" is activated, there is a difference of a few seconds when the system switches to "FM" analogue radio with sometimes a variation in volume.
Once the digital signal is restored, the system automatically changes back to "DAB".

! If the "DAB" station being listened to is not available on "FM" ("**DAB/FM**" option greyed out), or "DAB/FM auto tracking" is not activated, the sound will cut out while the digital signal is too weak.

Media

USB player

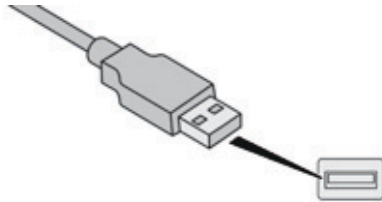

Insert the USB memory stick into the USB port or connect the USB device to the USB port using a suitable cable (not supplied).

The system builds playlists (in temporary memory), an operation which can take from a few seconds to several minutes at the first connection.

Reduce the number of non-music files and the number of folders to reduce the waiting time. The playlists are updated every time the ignition is switched off or connection of a USB memory stick. The lists are memorised: if they are not modified, the subsequent loading time will be shorter.

Auxiliary (AUX) socket



This source is only available if "Auxiliary input" has been checked in the audio settings.

Connect the portable device (MP3 player...) to the auxiliary Jack socket using an audio cable (not supplied).

First adjust the volume of your portable device (to a high level). Then adjust the volume of your audio system.

Display and management of the controls are via the portable device.

Selecting the source



Press **Radio Media** to display the primary page.



Select "**Source**".

Choose the source.

Bluetooth® audio streaming

Streaming allows you to listen to music from your telephone.

The Bluetooth profile must be activated. First adjust the volume on your portable device (to a high level).

Then adjust the volume of your audio system.

If play does not start automatically, it may be necessary to start the audio playback from the telephone.

Control is from the portable device or by using the audio system buttons.

! Once connected in streaming mode, the telephone is considered to be a media source.

Connecting Apple® players

Connect the Apple® player to the USB port using a suitable cable (not supplied). Play starts automatically.

Control is via the audio system.

i The classifications available are those of the portable device connected (artists / albums / genres / playlists / audiobooks / podcasts). The default classification used is by artist. To modify the classification used, return to the first level of the menu then select the desired classification (playlists for example) and confirm to go down through the menu to the desired track.

The version of software in the audio system may not be compatible with the generation of your Apple® player.

Information and advice

The audio equipment will only play audio files with ".wma, .aac, .flac, .ogg and .mp3" file extensions and with a bit rate of between 32 Kbps and 320 Kbps. It also supports VBR (Variable Bit Rate) mode. No other type of file (.mp4, ...) can be played. ".wma" files must be of the standard wma 9 type. The sampling rates supported are 32, 44 and 48 KHz.

It is advisable to restrict file names to 20 characters, without using of special characters (e.g.: " " ? ; ù) to avoid any playing and displaying problems.





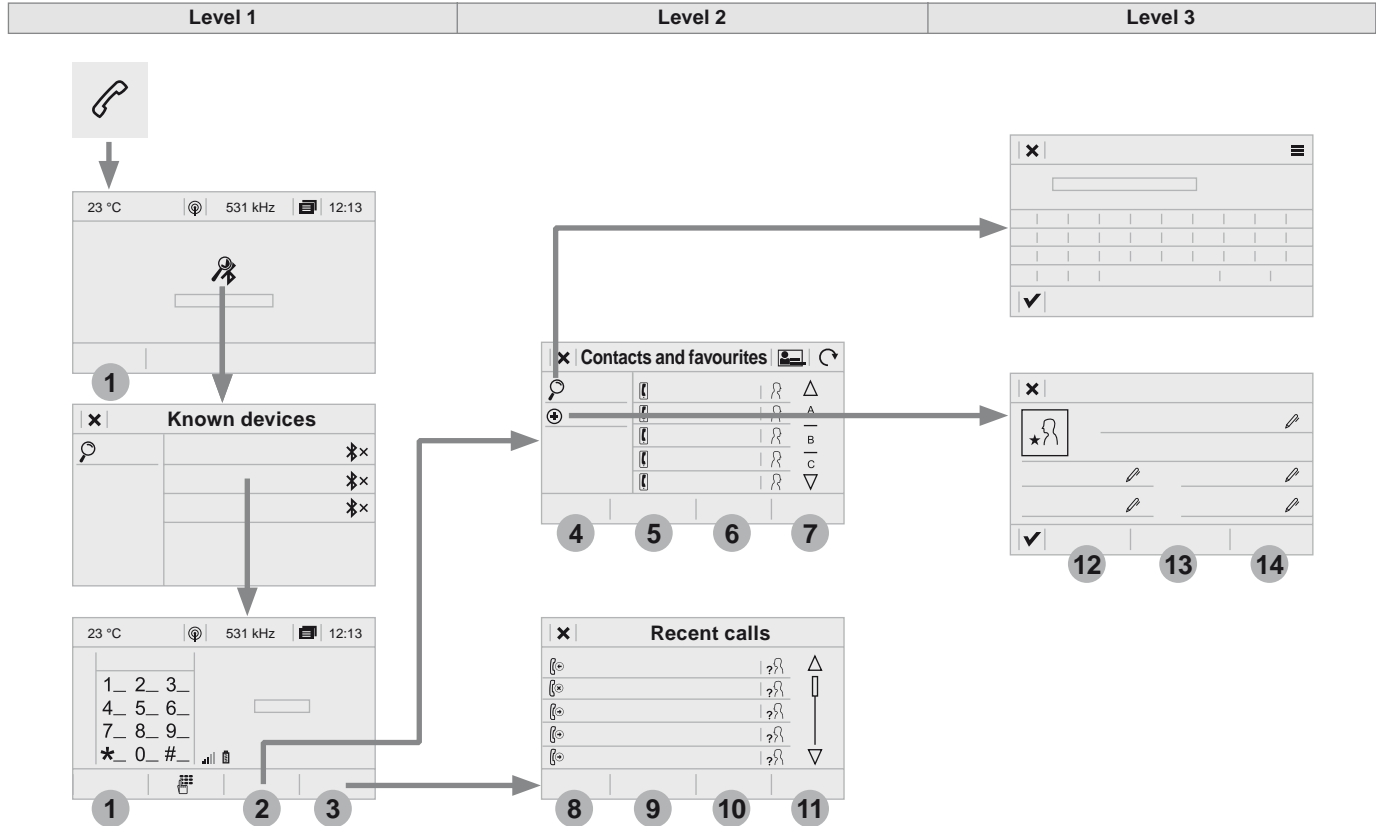

! The system supports USB mass storage devices, BlackBerry® devices or Apple® players via USB ports. The adaptor cable is not supplied. Control of the peripheral device is with the audio system controls. Other peripherals, not recognised on connection, must be connected to the auxiliary socket using a Jack cable (not supplied) or via Bluetooth streaming, depending on compatibility.

Use only USB memory sticks formatted FAT32 (file allocation table).





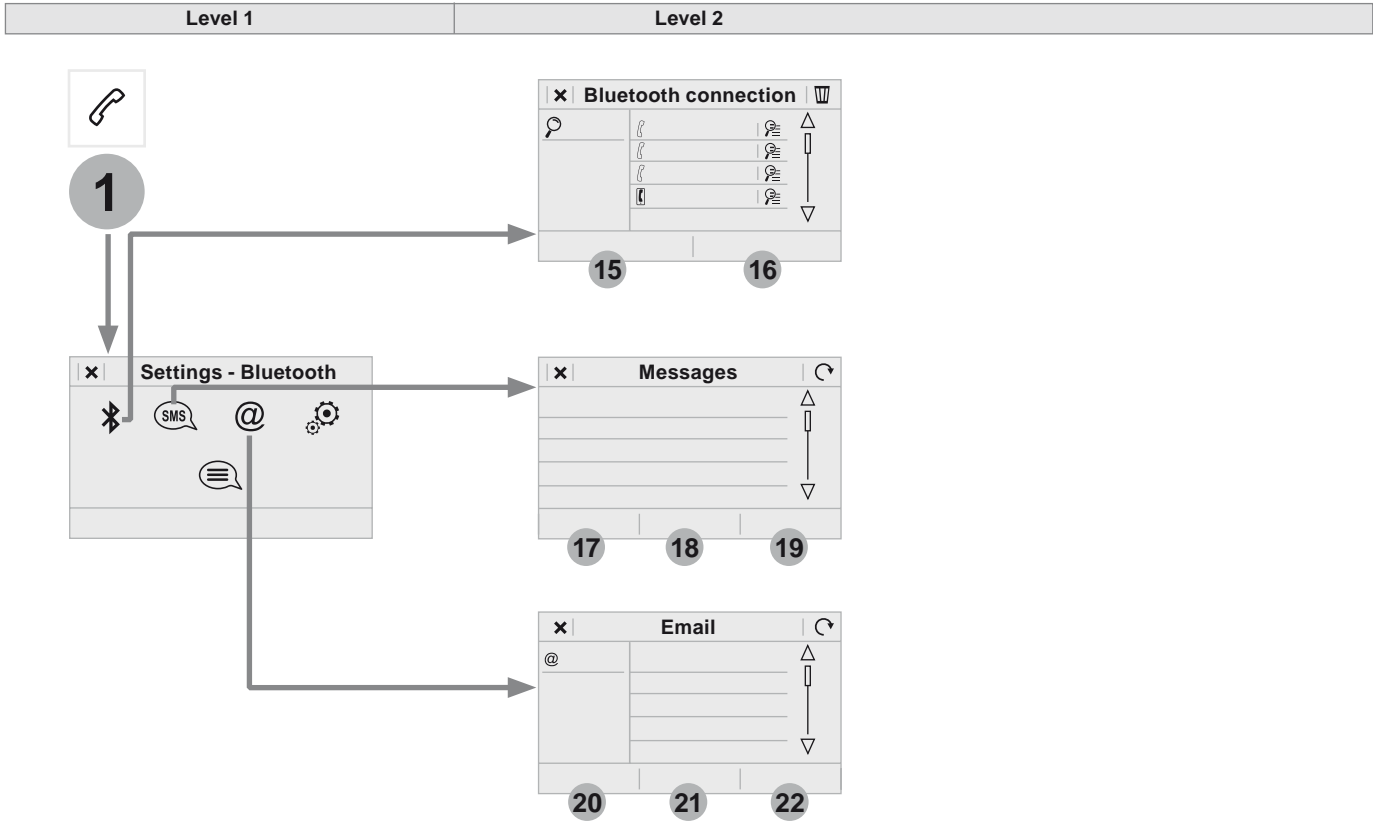

i It is recommended that the USB cable for the portable device is used.

Telephone







| Level 1 | | Level 2 | | Level 3 | | Comments | |
|---|---|---------------|---|---------------|-------------------------------------|--|--|
|  2 | Telephone ↓ Bluetooth ↓ Contact | 4 | All | | | View contacts according to presentation choices. Select a contact or a favourite saved in the system via the profile selected to start the call. | |
| | | 5 | Telephone | | | | |
| | | 6 | Address | | | | |
| | | 7 | Favourites | | | | |
| | | |  | | | | Sort the contacts by Surname-First name or First name-Surname. |
| | | |  | | | | Update the contacts from the telephone. |
| | | |  | Search | <input checked="" type="checkbox"/> | Confirm | Search for a contact in the directory. |
| | + | Create | 12 | Telephone | Create a new contact in the system. | | |
| | | | 13 | Address | | | |
| | | | 14 | Email | | | |
| | | | <input checked="" type="checkbox"/> | Confirm | | | |
|  3 | Telephone ↓ Bluetooth ↓ Calls | 8 | All | | | View calls according to choice of presentation. Select a contact to start the call. | |
| | | 9 | Incoming | | | | |
| | | 10 | Outgoing | | | | |
| | | 11 | Missed | | | | |
| | | |  | | | | View details for the contact. |

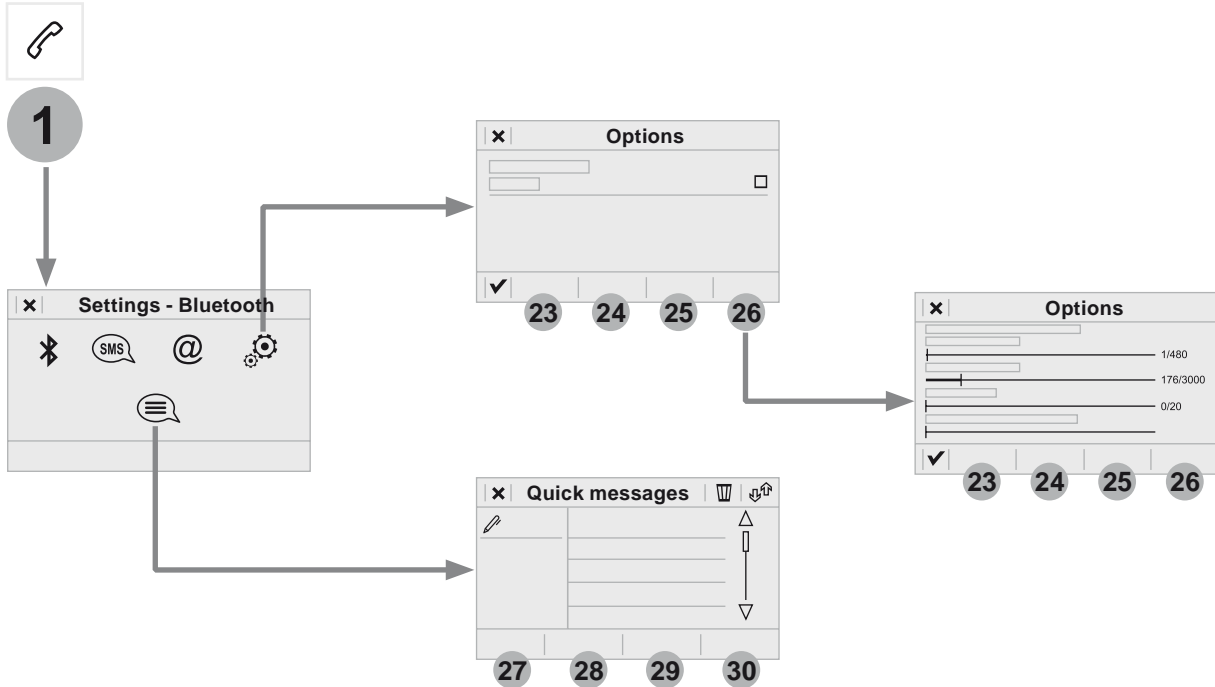

| Level 1 | | Level 2 | | Comments |
|--|---|---|-----------|--|
|  1  | Telephone ↓ Secondary page ↓ Bluetooth connection | 15 | All | Display all telephones, connected or disconnected, recognised by the system. |
| | | 16 | Connected | Display all connected telephones. |
| | |  | Search | Start the search for a device to connect. |
|  1  | Telephone ↓ Secondary page ↓ Messages | 17 | All | Display messages according to the choice made. |
| | | 18 | Received | |
| | | 19 | Sent | |
|  1  | Telephone ↓ Secondary page ↓ Email | 20 | Received | Display emails according to the choice made. |
| | | 21 | Sent | |
| | | 22 | Not read | |
| | | @ | Mailbox | |



| Level 1 | | Level 2 | | Comments |
|--|--|---|---------------|--|
|  1  | <p style="text-align: center;">Telephone ↓ Secondary page ↓ Options</p> | 23 | Security | Make driving safe. |
| | | 24 | Voicemail | Enter and save the number for the telephone voicemail. |
| | | 25 | Ringtone | Adjust the ringtone volume. |
| | | 26 | Statistics | Display data for the telephone connected. |
| | | ✓ | Confirm | Save the options. |
|  1  | <p style="text-align: center;">Telephone ↓ Secondary page ↓ Quick messages</p> | 27 | Delayed | Select a quick message from the categories, as required. |
| | | 28 | My arrival | |
| | | 29 | Not available | |
| | | 30 | Other | Create a quick message. |
| | |  | Create | |

Pairing a Bluetooth® telephone

! As a safety measure and because it requires sustained attention by the driver, the pairing of a Bluetooth mobile telephone with the Bluetooth hands-free system of your audio system must be done with the **vehicle stationary** and the ignition on.

i Activate the Bluetooth function on the telephone and ensure that it is "visible to all" (telephone configuration).

Procedure from the telephone

 Select the system name in the list of devices detected.

In the system, accept the connection request from the telephone.

! To complete the pairing, whichever procedure used (from the telephone or from the system), ensure that the code is the same in the system and in the telephone.

Procedure from the system



Press **Telephone** to display the primary page.



Press **Connect telephone**.

Or



Select "**Search**".
The list of telephones detected is displayed.

i If the pairing procedure fails, it is recommended that you deactivate and then reactivate the "Bluetooth" function in your telephone.



Select the name of the chosen telephone in the list.

Connection sharing

The system offers to connect the telephone with 3 profiles:

- **Telephone** (hands-free kit, telephone only),
- **Streaming** (wireless play of audio files on the telephone),
- **Mobile internet data**.



Select one or more profiles.



Press "**Confirm**".

i Depending on the type of telephone, you may be asked to accept or not the transfer of your contacts and messages.

Automatic reconnection

i On return to the vehicle, if the last telephone connected is present again, it is automatically recognised and within about 30 seconds of switching on the ignition, the connection is established without any action on your part (Bluetooth activated).

To modify the connection profile:



Press **Telephone** to display the primary page.



Press the "**OPTIONS**" button to go to the secondary page.



Select "**Bluetooth connection**" to display the list of paired devices.



Press the "details" button.



Select one or more profiles.



Press on "**Confirm**".



The ability of the system to connect with just one profile depends on the telephone. All three profiles may connect by default.



The services available depend on the network, the SIM card and the compatibility of the Bluetooth devices used. Check in your telephone's manual and with your service provider for the services available to you.



The profiles compatible with the system are HFP, OPP, PBAP, A2DP, AVRCP, MAP and PAN.

Go to the brand's website for more information (compatibility, additional help, ...).

Managing paired telephones

i This function allows the connection or disconnection of a peripheral device as well as the deletion of a pairing.



Press **Telephone** to display the primary page.

1

Press the "**OPTIONS**" button to go to the secondary page.



Select "**Bluetooth connection**" to display the list of paired peripheral devices.



Press on the name of the telephone chosen in the list to disconnect it. Press again to connect it.

Deleting a telephone



Select the basket at top right of the screen to display a basket alongside the telephone chosen.



Press the basket alongside the telephone chosen to delete it.

Receiving a call

An incoming call is announced by a ring and a superimposed display in the screen.



Make a short press on the steering mounted **TEL** button to accept an incoming call.

And



Make a long press



on the steering mounted **TEL** button to reject the call.

Or



Select "**End call**".

Making a call

- ! Using the telephone is not recommended while driving. Park the vehicle. Make the call using the steering mounted controls.

Calling a new number



Press **Telephone** to display the primary page.



Enter the phone number using the digital keypad.



Press "**Call**" to start the call.

Calling a contact



Press **Telephone** to display the primary page.



Or make a long press



on the steering mounted **TEL** button.



Select "**Contact**".

Select the desired contact from the list offered.



Select "**Call**".

Calling a recently used number



Press **Telephone** to display the primary page.

Or



Make a long press



on the steering mounted button.



Select "**Calls**".

Select the desired contact from the list offered.



It is always possible to make a call directly from the telephone; as a safety measure, first park the vehicle.

Managing contacts / entries



Press **Telephone** to display the primary page.

2

Select "**Contact**".



Select "**Create**" to add a new contact.

12

In the "**Telephone**" tab, enter the telephone numbers for the contact.

13

In the "**Address**" tab, enter the addresses for the contact.

14

In the "**Email**" tab, enter the email addresses for the contact.



The "**Email**" function allows email addresses to be entered for a contact, but the system is not able to send emails.

Managing messages



Press **Telephone** to display the primary page.

1

Press the "**OPTIONS**" button to go to the secondary page.



Select "**Messages**" to display the list of messages.



Select the "**All**" or "**Received**" or "**Sent**" tab.



Select the detail of the message chosen in one of the lists



Press "**Answer**" to send a quick message stored in the system.



Press "**Call**" to start the call.



Press "**Play**" to hear the message.



The access to "**Messages**" depends on the compatibility of the smartphone and the integral system.
Depending on the smartphone, access to your messages or email may be slow.



The services available depend on the network, the SIM card and the compatibility of the Bluetooth devices used.
Check in the manual for your telephone and with your service provider for the services available to you.

Managing quick messages



Press **Telephone** to display the primary page.



Press on the "**OPTIONS**" button to go to the secondary page.



Select "**Messages**" to display the list of messages.



Select the "**Delayed**" or "**My arrival**" or "**Not available**" or "**Other**" tab with the possibility of creating new messages.



Press "**Create**" to write a new message.



Select the message chosen in one of the lists.



Press "**Transfer**" to select the addressee(s).



Press "**Play**" to play the message.



Press this button to "**Modify**" the new quick message(s) created.



The "**Modify**" function does not apply to quick messages already present in the system.

Managing email



Press **Telephone** to display the primary page.



Press the "**OPTIONS**" button to go to the secondary page.



Select "**Email**" to display the list of messages.



Select the "**Received**" or "**Sent**" or "**Not read**" tab.

Select the email chosen in the list.









Press "**Play**" to hear the email.

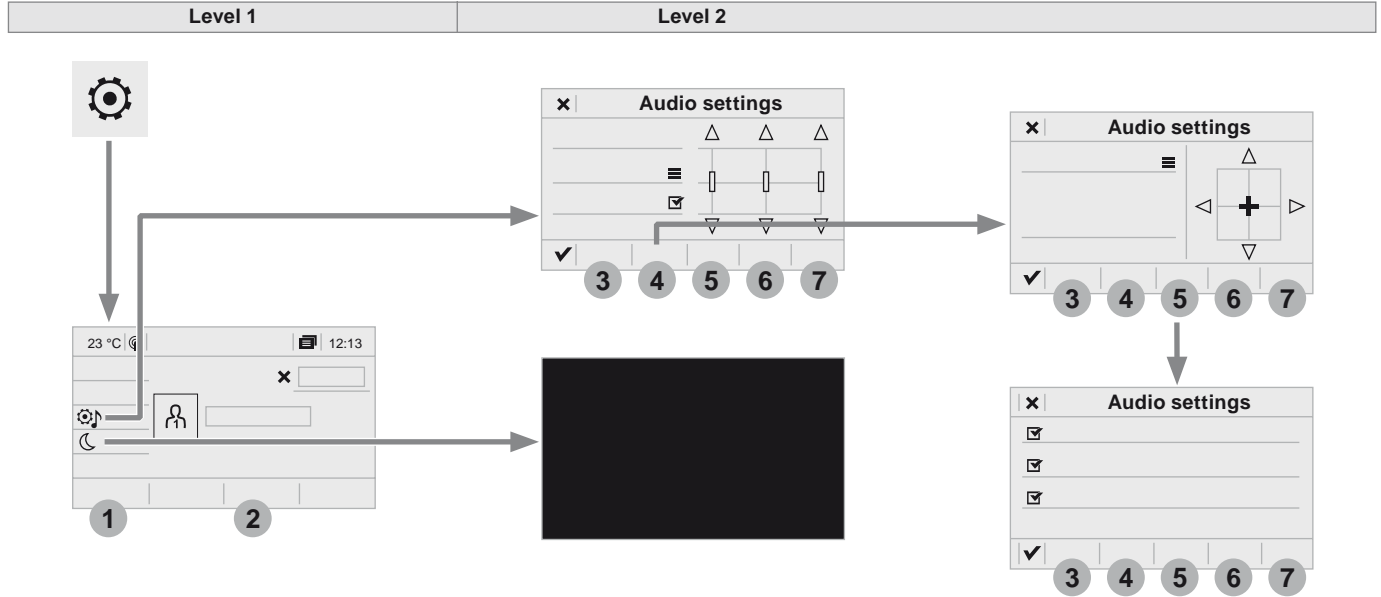









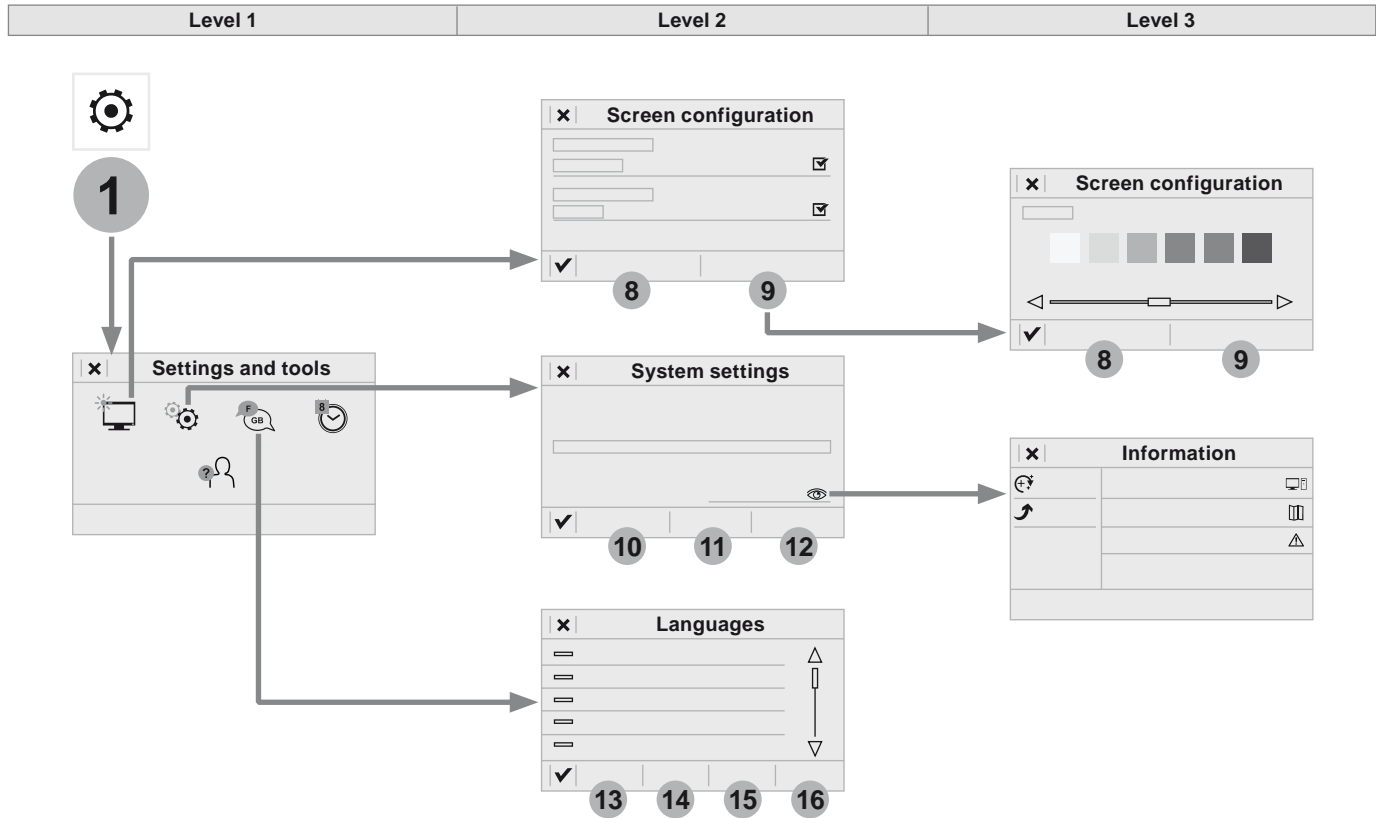





Access to "**Email**" depends on the compatibility of the smartphone and the integral system.





















Settings



| Level 1 | | Level 2 | | Comments |
|--|--|---|---------------------|---|
|   | Settings ↓ Audio settings | 3 | Ambience | Select the sound ambience. |
| | | 4 | Distribution | Sound distribution by the Arkamys® system. |
| | | 5 | Sound | Adjust the volume or activate volume linked to speed. |
| | | 6 | Voice | Adjust the voice volume. |
| | | 7 | Ringtone | Adjust the ringtone volume. |
| | | ✓ | Confirm | Save the settings. |
|   | Settings ↓ Turn off screen |  | | Function allowing the display to be switched off. Pressing the screen reactivates it. |
|  2 | Settings ↓ Profile (1, 2, 3) | | | Activate the profile selected. |



| Level 1 | | Level 2 | | Level 3 | | Comments |
|--|---|-----------|-------------------------|---|-----------------------------------|--|
|  1  | Settings ↓ Secondary page ↓ Screen configuration | 8 | Animation | <input checked="" type="checkbox"/> | | Activate or deactivate settings. |
| | | 9 | Brightness | | | Adjust the level of brightness. |
| | | ✓ | Confirm | | | Save the settings. |
|  1  | Settings ↓ Secondary page ↓ System settings | 10 | Units |  | Distance and fuel consumption | Set the units used for distance, fuel consumption and temperature. |
| |  | | | Temperature | | |
| | | 11 | Factory settings |  | Reinitialize | Return to the factory settings. |
| | | 12 | System info |  | View | View the versions of the different modules (system, mapping, risk areas) installed in the system as well as the updates available. |
| | | ✓ | Confirm | | | Save the settings. |
|  1  | Settings ↓ Secondary page ↓ Languages | 13 | All |  | Select the language then confirm. | |
| | | 14 | Europe |  | | |
| | | 15 | Asia |  | | |
| | | 16 | America |  | | |
| | | ✓ | Confirm | | | Having selected the language, save the setting. |

| Level 1 | | Level 2 | | Level 3 | | Comments |
|---|--|--|-----------------------|---|--|----------|
|    | Settings ↓ Secondary page ↓ Setting the time-date |  17 | Date |  Date | Enter the date and select the date format. | |
| | | | |  Date format: | | |
| | |  18 | Time |  Time | Set the time. | |
| | | | |  Time Zone | Define the time zone. | |
| | | | |  Time format: | Select the time format: 12h / 24h. | |
| | | | |  Synchronisation with GPS (UTC): | Activate or deactivate synchronisation with GPS. | |
|  | Confirm | | Save the settings. | | | |
|    | Settings ↓ Secondary page ↓ Setting of the profiles |  19 | Profile 1 | | Enter settings for the profiles. | |
| | |  20 | Profile 2 | | | |
| | |  21 | Profile 3 | | | |
| | |  22 | Common profile | | | |
| | |  | Confirm | | Save the settings. | |

Audio settings



Press **Settings** to display the primary page.



Select "**Audio settings**".



Select "**Ambience**".

Or



"**Position**"

Or



"**Sound**"

Or



"**Voice**"

Or



"**Ringtone**".



Press "**Confirm**" to save the settings.

! The sound distribution (or spatialisation with the Arkamys® system) is audio processing that allows the quality of the sound to be adapted according to the number of passengers in the vehicle. Available only with the 6-speaker configuration.

i The audio **Ambience** settings (6 ambiances available) as well as the **Bass**, **Medium** and **Treble** settings are different and independent for each sound source. Activate or Deactivate "**Loudness**".

The settings for "**Position**" (All passengers, Driver and Front only) are common to all sources.

Activate or Deactivate "**Touch tones**", "**Volume linked to speed**" and "**Auxiliary input**".

i On-board audio: Arkamys® Sound Staging optimises the distribution of sound in the passenger compartment.

Profile settings

! As a safety measure and because it requires the sustained attention of the driver, changes to settings must only be done with the **vehicle stationary**.



Press **Settings** to display the primary page.



Press the "**OPTIONS**" button to go to the secondary page.



Select "**Setting of the profiles**".



Select "**Profile 1**", "**Profile 2**", "**Profile 3**" or "**Common profile**".



Press this button to enter a name for the profile using the virtual keypad



Press "**Confirm**".



Press this button to add a photograph to the profile.



Insert a USB memory stick containing the photograph in the USB port. Select the photograph.



Press "**Confirm**" to accept the transfer of the photograph.



Press "**Confirm**" again to save the settings.

i The location for the photograph is square; the system deforms the original photograph if in another format.

00.0

Press this button to initialise the profile selected.



Initialisation of the profile selected activates the English language by default.

2

Select a "**Profile**" (1 or 2 or 3) to associate the "**Audio settings**" with it.



Select "**Audio settings**".

3

Select "**Ambience**".

Or

4

"**Distribution**".

Or

5

"**Sound**".

Or

6

"**Voice**".

Or

7

"**Ringtone**".



Press "**Confirm**" to save the settings.

Modifying system settings



Press **Settings** to display the primary page.



Press the "**OPTIONS**" button to go to the secondary page.



Select "**Screen configuration**".



Select "**Animation**".



Activate or deactivate "**Automatic scrolling**".



Select "**Brightness**".



Adjust the brightness of the screen.



Press **Settings** to display the primary page.



Press the "**OPTIONS**" button to go to the secondary page.



Select "**System settings**".



Select "**Units**" to change the units for distance, fuel consumption and temperature.



Select "**Factory settings**" to return to the initial settings.

! Returning the system to factory settings activates the English language by default.



Select "**System info**" to display the versions of the different modules installed in the system.

Select the language



Press **Settings** to display the primary page.



Press the "**OPTIONS**" button to go to the secondary page.



Select "**Languages**" to change the language.

Setting the date



Press **Settings** to display the primary page.



Press the "**OPTIONS**" button to go to the secondary page.



Select "**Setting the time-date**".

17

Select "**Date**".

Press this button to define the date.

Press "**Confirm**".

Select the display format of the date.

i Adjustment of the time and date is only available if synchronisation with GPS is deactivated.
The change between winter and summer time is done by changing the time zone.

Setting the time

Press **Settings** to display the primary page.

1

Press the "**OPTIONS**" button to go to the secondary page.Select "**Setting the time-date**".

18

Select "**Time**".

Press this button to adjust the time using the virtual keypad.

Press "**Confirm**".

Press this button to define the time zone.



Select the display format for the time (12h / 24h).



Activate or deactivate synchronisation with GPS (UTC).

Press "**Confirm**".

i The system does not automatically manage the change between winter and summer time (depending on country).

Frequently asked questions

The following table groups together the answers to the most frequently asked questions concerning your audio system.

Radio

| QUESTION | ANSWER | SOLUTION |
|---|--|---|
| The quality of reception of the radio station listened to gradually deteriorates or the stored stations do not function (no sound, 87.5 Mhz is displayed...). | The vehicle is too far from the transmitter used by the station listened to or there is no transmitter in the geographical area through which the vehicle is travelling. | Activate the "RDS" function by means of the short-cut menu to enable the system to check whether there is a more powerful transmitter in the geographical area. |
| | The environment (hills, buildings, tunnels, basement car parks...) | This phenomenon is normal and does not indicate a fault with the audio system. |
| | The aerial is absent or has been damaged (for example when going through a car wash or into an underground car park). | Have the aerial checked by a franchised dealer. |
| I cannot find some radio stations in the list of stations received. | The station is not received or its name has changed in the list. | Press on the "Update list" button in the "Radio stations" secondary menu. |
| The name of the radio station changes. | Some radio stations send other information in place of their name (the title of the song for example). The system interprets this information as the name of the station. | |

Media

| QUESTION | ANSWER | SOLUTION |
|--|--|--|
| Playback of my USB memory stick starts only after a very long wait (around 2 to 3 minutes). | Some files supplied with the memory stick may greatly slow down access to reading the memory stick (multiplication by 10 of the catalogue time). | Delete the files supplied with the memory stick and limit the number of sub-folders in the file structure on the memory stick. |
| Some characters in the media information are not displayed correctly while playing. | The audio system does not display some types of characters. | Use standard characters to name tracks and folders. |
| Playing of streaming files does not start. | The peripheral device connected does not support automatic play. | Start the playback from the device. |
| The names of tracks and the track length are not displayed on the screen when streaming audio. | The Bluetooth profile does not allow the transfer of this information. | |

Telephone

| QUESTION | ANSWER | SOLUTION |
|---|--|--|
| I cannot connect my Bluetooth telephone. | The telephone's Bluetooth function may be switched off or the telephone may not be visible. | Check that your telephone's Bluetooth function is switched on. Check in the telephone settings that it is "visible to all". |
| | The Bluetooth telephone is not compatible with the system. | You can check the compatibility of your telephone at the brand's website (services). |
| The volume of the telephone connected in Bluetooth mode is inaudible. | The volume depends both on the system and on the telephone. | Increase the volume of the audio system, to maximum if required, and increase the volume of the telephone if necessary. |
| | The ambient noise level has an influence on the quality of telephone communication. | Reduce the ambient noise level (close the windows, reduce the booster fan speed, slow down, ...). |
| Some contacts are duplicated in the list. | The options for synchronizing contacts are synchronizing the contacts on the SIM card, the contacts on the telephone, or both. When both synchronizations are selected, some contacts may be duplicated. | Select "Display SIM card contacts" or "Display telephone contacts". |
| Contacts are not shown in alphabetical order. | Some telephones offer display options. Depending on the settings chosen, contacts can be transferred in a specific order. | Modify the display setting in the telephone directory. |
| The system does not receive SMS text messages. | The Bluetooth mode does not permit sending SMS text messages to the system. | |

Settings

| QUESTION | ANSWER | SOLUTION |
|---|--|--|
| In changing the setting of treble and bass the equalizer setting is deselected. | The selection of an equalizer setting imposes the settings for treble and bass and vice-versa. | Modify the treble and bass or equalizer settings to obtain the desired musical ambience. |
| In changing the equalizer setting, treble and bass return to zero. | | |
| When changing the balance settings, the distribution setting is deselected. | The selection of a distribution setting imposes the balance settings and vice-versa. | Modify the balance or distribution settings to obtain the desired musical ambience. |
| When changing a distribution setting, the balance setting is deselected. | | |

| QUESTION | ANSWER | SOLUTION |
|---|--|---|
| There is a difference in sound quality between the different audio sources. | For optimum sound quality, the audio settings for Loudness, Ambience, Treble, Bass and Volume can be adapted to the different sound sources, which may result in audible differences when changing source. | Check that the audio settings for Loudness, Ambience, Treble, Bass and Volume are adapted to the sources listened to. Adjust the Balance, Treble and Bass to the middle position, select the "None" musical ambience and set the loudness correction to the "Active" position in CD mode or to the "Inactive" position in radio mode. |
| With the engine off, the system switches off after a few minutes of use. | When the engine is switched off, the system's operating time depends on the state of charge of the battery. The switch-off is normal: the system switches to economy mode and switches off to prevent discharging of the vehicle's battery. | Start the vehicle's engine to increase the battery charge. |

Bluetooth® audio system

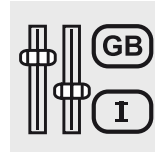
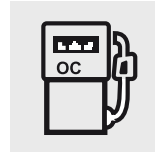

| | Contents |
|--|----------|
| First steps | 484 |
| Steering mounted controls - Type 1 | 485 |
| Steering mounted controls - Type 2 | 486 |
| Menus | 487 |
| Radio | 488 |
| DAB (Digital Audio Broadcasting) radio | 490 |
| Media | 492 |
| Telephone | 497 |
| Frequently asked questions | 502 |

i The different functions and adjustments described vary according to the version and configuration of your vehicle.

i Your audio system is coded in such a way that it will only operate in your vehicle.

! As a safety measure and because it requires the sustained attention of the driver, the pairing of your Bluetooth telephone to the Bluetooth hands-free audio system must only be carried out with the **vehicle stationary** and the ignition on. To avoid discharging the battery, the audio system may switch off after a few minutes if the engine is not running.

First steps



Press: On / Off
Rotate: adjust volume.

SRC /

Short press: change audio source (Radio; USB; AUX (if a device is connected); CD; Streaming).
Long press: display the telephone menu (if a telephone is connected).



Adjust audio settings:
Front/rear fader; left/right balance; bass/treble; loudness; audio ambience.
Activation / deactivation of automatic volume adjustment (linked to the speed of the vehicle).

LIST

Radio:
Short press: display the list of radio stations.
Long press: update the list.
Media:
Short press: display the list of folders.
Long press: display the sorting options.



Select the screen display mode, between:
Date; Audio functions; Trip computer; Telephone.

OK

Confirm or display contextual menu.

1

Buttons 1 to 6.
Short press: select the preset radio station.
Long press: preset a station.



Radio:
Automatic step by step search up / down for radio stations.
Media:
Select previous / next CD, USB, streaming track.
Scroll in a list.



Radio:
Manual step by step search up / down for radio stations.
Select previous / next MP3 track.

Media:
Select previous / next folder / genre / artist / playlist on the USB device.
Scroll in a list.



Abandon the current operation.
Go up one level (menu or folder).

MENU

Access to main menu.

TA

Activate / Deactivate TA (traffic announcements)
Long press: select type of announcement.

BAND

Select waveband: FM / DAB / AM.



Steering mounted controls - Type 1

**Radio:**

Select the previous / next preset radio station.

Select the previous / next item in a menu or a list.

Media:

Select of the previous / next track

Select the previous / next item in a menu or a list.

LIST**Radio:**

Short press: display the list of radio stations.

Long press: update the list.

Media:

Short press: display the list of folders.

Long press: display the sorting options.

SRC /**Other than telephone calls:**

Short press: change audio source (Radio; USB; AUX (if a device is connected); CD; Streaming), confirm if the **"Telephone"** menu is open.
Long press: open the **"Telephone"** menu.

In the event of a telephone call:

Short press: accept the call.

Long press: reject the call.

During a telephone call:

Short press: open the contextual telephone menu.

Long press: end the call.

OK

Confirm a selection.



Increase volume.



Decrease volume.



Mute / Restore sound by simultaneously pressing the increase and decrease volume buttons.



Steering mounted controls - Type 2

MENU

Access to the main menu.



Increase volume.



Mute / Restore sound.



Decrease volume.

SRC /

Other than telephone call:

Short press: change audio source (Radio; USB; AUX (if a device is connected); CD; Streaming), confirm if the "**Telephone**" menu is open.
Long press: open the "**Telephone**" menu.

In the event of a telephone call:

Short press: accept the call.
Long press: reject the call.

During a telephone call:

Short press: open the contextual telephone menu.
Long press: end the call.



Start voice recognition of your smartphone via the system.

LIST

Radio:

Short press: display the list of radio stations.

Long press: update the list.

Media:

Short press: display the list of folders.

Long press: display the sorting options.



Radio:

Select the previous / next preset radio station.

Select the previous / next item in a menu or a list.

Media:

Select the previous / next track.

Select the previous / next item in a menu or a list.

Press the thumbwheel: confirm.

Menus

Depending on version.



"Multimedia": Media settings, Radio settings.

MENU

Press the **"MENU"** button.



"Telephone": Call, Directory management, Telephone management, End call.



Move from one menu to another.



"Trip computer".

OK

Enter a menu.



"Maintenance": Diagnosis, Warning log, ...



"Connections": Manage connections, search for devices.



"Personalisation-configuration": Define the vehicle settings, Choice of language, Display configuration, Choice of units, Date and time adjustment.

Radio

Selecting a station

SRC / Press the **SOURCE** button repeatedly and select the radio.

BAND Press this button to select a waveband (FM / AM / DAB).

◀▶ Press one of the buttons to carry out an automatic search for radio stations.

▲▼ Press one of the buttons to carry out a manual search up / down for radio frequencies.

LIST Press this button to display the list of stations received locally. To update this list, press for more than two seconds. The sound is cut while updating.

RDS

i The external environment (hills, buildings, tunnels, basement car parks, ...) may block reception, including in RDS mode. This is a normal effect of the way in which radio waves are transmitted and does not indicate any failure of the audio system.

i If RDS is not available, the RDS symbol appears barred in the screen.

! RDS, if activated, enables you to continue listening to the same station by automatic retuning to alternative frequencies. However, in certain conditions, coverage of an RDS station may not be assured throughout the country as radio stations do not cover 100 % of the territory. This explains the loss of reception of a station that can occur during a journey.

Short procedure

In **"Radio"** mode, press the **OK** button to activate or deactivate RDS directly.

Long procedure

MENU Press the **"MENU"** button.

◀▶ Select **"Audio functions"**.

OK Press **OK**.

◀▶ Select the **"FM waveband preferences"** function.

OK Press **OK**.

◀▶ Select **"RDS"**.

OK Press **OK**, RDS is displayed in the screen.

Receiving TA messages

! The TA (Traffic Announcement) function gives priority to TA alert messages. To operate, this function needs good reception of a radio station transmitting this type of message. When a traffic report is transmitted, the current audio source (Radio, CD, ...) is interrupted automatically to play the TA message. Normal playback of the audio source resumes at the end of the transmission of the message.

! Take care when increasing the volume while listening to TA messages. The volume may prove too high on return to the original audio source.

TA Press the **TA** button to activate or deactivate traffic messages.

Receiving INFO messages

i The INFO function gives priority to TA traffic announcements. To be active, this function needs good reception of a radio station that transmits this type of message. When a message is transmitted, the current audio source (Radio, CD, USB, ...) is interrupted automatically to receive the INFO message. Normal play resumes at the end of the message transmission.

TA Make a long press on this button to display the list of categories.

▲▼ Select or deselect categories.

OK Activate or deactivate the reception of the corresponding messages.

Display RADIO TEXT

i Radio text is information transmitted by the radio station related to the current programme or song.

OK With the radio displayed on the screen, press **OK** to display the contextual menu.

▲▼ Select "**RadioText (TXT) display**" and confirm **OK** to save.

DAB (Digital Audio Broadcasting) radio

Display options:
if active but not available, the display will
be struck out.

i If the current "DAB" radio station is not available on "FM", "DAB FM" is barred.



Display the name of the current radio station.

Preset radio station, buttons 1 to 6.
Short press: select the preset radio station.
Long press: preset a radio station.

Display the name of the multiplex service being used.

Represents the signal strength for the band being listened to.

Display RadioText (TXT) for the current radio station.

i When changing region, an update of the list of preset radio stations is advisable.

LIST Display the list of all radio stations and "multiplexes".

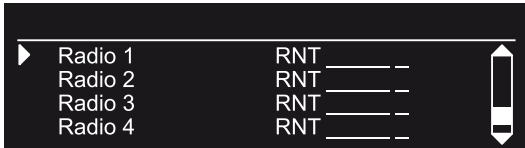

Digital radio

i Digital radio provides a superior audio quality and also additional categories of traffic announcements (TA INFO). The different "multiplex services" offer a choice of radio stations in alphabetical order.

BAND

Change band (FM1, FM2, DAB, ...).



Change of station within the same "multiplex service".



Start a search for the previous / next "multiplex service".

TA

Long press: select the desired categories of announcements from Transport, News, Entertainment and Flash special (availability according to the station).

i When the radio station is displayed in the screen, press on "OK" to display the contextual menu. (Frequency search (RDS), DAB / FM auto tracking, RadioText (TXT) display, Information on the station, ...)

MENU

Press the "Menu" button.



Select "Multimedia" and confirm.



Select "DAB / FM auto tracking" and confirm

DAB / FM tracking

i "DAB" does not have 100% coverage of the country. When the digital signal is weak, "DAB / FM auto tracking" allows you to continue listening to the same station, by automatically switching to the corresponding analogue "FM" station (if there is one). When "DAB / FM auto tracking" is active, the DAB station will be selected automatically.



If "DAB / FM auto tracking" is activated, there will be a difference of a few seconds in the programme when the system changes to analogue "FM" radio, with sometimes a variation in volume.



If the "DAB" station you are listening to is not available on "FM" ("DAB/FM" option barred), or if "DAB / FM auto tracking" is not on, the sound will be cut when the digital signal is too weak.

Media

USB player

This unit consists of a USB port and an auxiliary Jack socket, depending on model.

! The system creates playlists (temporary memory), which can take from a few seconds to several minutes on the first connection. Reducing the number of non-music files and the number of folders reduces this waiting time. Playlists are updated every time a new USB memory stick is connected.

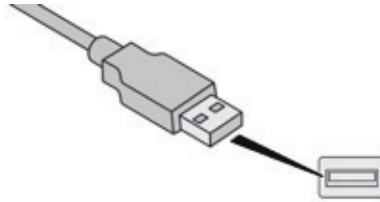

Insert a USB memory stick into the USB port or connect a USB peripheral device to the USB port using a suitable cable (not supplied). The system changes automatically to "USB" source.

i While connected by USB, the portable device may be charged automatically.

Play mode

The play modes available are:

- **Normal:** the tracks are played in order, depending on the classification of the selected files.
- **Random:** the tracks in an album or folder are played in a random order.
- **Random on all media:** all of the tracks saved in the media are played in random order.
- **Repeat:** the tracks played are only those from the current album or folder.

OK

Press this button to display the contextual menu for the Media function.



Press this button to select the play mode.

OK

Press this button to confirm.

The choice made is displayed at the top of the screen.

Choosing a track to play



Press one of these buttons to go to the previous / next track.



Press one of these buttons to go to the previous / next folder.

File classification



Make a long press on this button to display the different classifications.



Choose by "**Folder**" / "**Artist**" / "**Genre**" / "**Playlist**".



Press **OK** to select the desired classification, then press **OK** again to confirm.

Playing files



Make a long press on this button to display the chosen classification.



Navigate in the list using the left / right and up / down buttons.



Confirm the selection by pressing **OK**.



Press one of these buttons to go to the previous / next track in the list. Press and hold one of these buttons for fast forward or fast back.



Press one of these buttons to go to the next "**Folder**" / "**Artist**" / "**Genre**" / "**Playlist**"* in the list.

* Depending on availability and the type of device used.

Jack auxiliary (AUX) socket



Connect the portable device (MP3 player, ...) to the auxiliary Jack socket using an audio cable (not supplied).

SRC / Press the **SOURCE** button several times in succession and select "**AUX**".

First adjust the volume on your portable device (to a high level). Then adjust the volume on your audio system. Operation of controls is via the portable device.

! Do not connect a device to both the Jack auxiliary socket and the USB port at the same time.

CD player

Insert circular compact discs only. Some anti-pirating systems, on original discs or CDs copied using a personal recorder, may cause faults which are no reflection on the quality of the vehicle's player. Insert a CD in the player, play begins automatically.

! External CD players connected via the USB port are not recognised by the system.

SRC / To play a disc which has already been inserted, press the **SOURCE** button several times in succession and select **CD**.

◀▶▶ Press one of the buttons to select a track on the CD.

LIST Press the **LIST** button to display the list of tracks on the CD.

◀▶▶ Press and hold one of the buttons for fast forward or fast back.

Playing an MP3 compilation

Insert an MP3 CD compilation in the player. The audio equipment searches for all of the music tracks, which may take anything between a few seconds and several tens of seconds, before play begins.

! On a single disc, the CD player can read up to 255 MP3 files spread over 8 folder levels. However, it is advisable to keep to a limit of two levels to reduce the access time before the CD is played. While the CD is being played, the folder structure is not followed. All of the files are displayed on a single level.

SRC /

To play a disc which has already been inserted, press the **SOURCE** button several times in succession and select **CD**.



Press one of the buttons to select a folder on the CD.



Press one of the buttons to select a track on the CD.

LIST

Press the **LIST** button to display the list of directories of the MP3 compilation.



Press and hold one of the buttons for fast forward or backward play.

Bluetooth® audio streaming

Streaming allows music files on the telephone to be played via the audio system.

Connect the telephone.
(Refer to the "**Pairing a telephone**" section).

SRC /

Activate the streaming source by pressing the **SOURCE*** button.

Play can be controlled using the buttons on the audio system control panel and the steering mounted controls**. Contextual information may be displayed in the screen.

* In certain cases, play of the audio files must be initiated from the keypad.

** If the telephone supports the function. The audio quality depends on the quality of transmission by the telephone.

Connecting Apple® players

Connect the Apple® player to the USB port using a suitable cable (not supplied). Play starts automatically.

Control is via the audio system.

The classifications available are those of the portable device connected (artists / albums / genres / playlists).

The version of software in the audio system may not be compatible with the generation of your Apple® player.

Information and advice

The CD player can play files with .mp3, .wma, .wav and .aac file extensions, with a bit rate of 32 to 320 Kbps.

It also supports TAG mode (ID3 tag, WMA TAG).

Other file types (mp4, ...) may be played.

Files of the ".wma" type should be to the wma 9 standard.

The sampling rates supported are 11, 22, 44 and 48 KHz.

File names should have less than 20 characters, avoiding special characters (e.g.: " ? ; ù) so as to avoid any reading or display problems.

In order to be able to play a recorded CDR or CDRW, the ISO 9660 level 1. 2 or Joliet file format is recommended when recording.

If the disc is recorded in another format, it may not be played correctly.

It is recommended that the same recording format is always used for an individual disc, with as low a speed as possible (4x maximum) for optimum sound quality.

In the particular case of a multi-session CD, the Joliet format is recommended.

Use only USB memory sticks formatted FAT32 (File Allocation Table).

i It is recommended that you use genuine Apple® USB cables for correct operation.

Telephone

Pairing a Bluetooth® telephone

! As a safety measure and because it requires the sustained attention of the driver, the pairing of your a Bluetooth telephone to the Bluetooth hands-free audio system must only be carried out with the vehicle stationary and the ignition on

i Activate the telephone's Bluetooth function and ensure that it is "visible to all" (telephone configuration).

i The services available depend on the network, the SIM card and the compatibility of the Bluetooth telephone used.
Refer to the instructions for your telephone and to your service provider for the services available to you.

Procedure from the telephone



Select the name of the system in the list of devices detected.

Procedure from the system

MENU

Press the **MENU** button.



Select the "**Connections**" menu.

OK

Confirm with **OK**.



Select "**Search for a Bluetooth device**".

OK

Confirm with **OK**.

A window is displayed with a search in progress message.

In the list of devices detected, select a telephone to pair. Only one telephone can be paired at a time.

Completing the pairing



To complete the pairing, whichever procedure is used (from the telephone or from the system), check that the code displayed in the system and the telephone is the same and confirm.

If pairing fails, the number of attempts is not restricted.

A message appears in the screen confirming the pairing.

Information and advice

The "**Telephone**" menu gives access to the following functions in particular: "**Directory**", "**Calls list**", "**View paired devices**". Depending on the type of telephone, you may be asked to accept or confirm access by the system to each of these functions.



Go to the brand's website or more information (compatibility, more help, ...).

* If your telephone is fully compatible.

Managing connections

i The telephone connection automatically includes hands-free operation and audio streaming. The ability of the system to connect to just one profile depends on the telephone. Both profiles may connect by default.

MENU

Press **MENU**.



Select "**Connections**".

OK

Confirm with **OK**.



Select "**Connections management**" and confirm. The list of paired devices is displayed.

OK

Confirm with **OK**.



Indicates that a device is connected.



A number indicates the profile of the connection with the system:

- 1 for media or 1 for telephone.
- 2 for media and telephone.



Indicates the audio streaming profile.



Indicates the hands-free telephone profile.



Select a telephone.

OK

Confirm with **OK**.



Then select and confirm:

- "**Connect telephone**" / "**Disconnect telephone**": to connect / disconnect the telephone or the hands-free kit only.
- "**Connect media player**" / "**Disconnect media player**": to connect / disconnect streaming only.
- "**Connect telephone + media player**" / "**Disconnect telephone + media player**": to connect / disconnect the telephone (hands-free kit and streaming).
- "**Delete connection**": to delete the pairing.



When you delete a pairing in the system, remember to delete it from your telephone as well.

OK

Confirm with **OK**.

Receiving a call

An incoming call is announced by a ring and a superimposed display in the screen.



Select the **"YES"** tab in the screen using the buttons.

OK

Confirm with **OK**.

SRC /

Press this button at the steering mounted controls to accept the call.

Making a call

In the **"Telephone"** menu.

Select **"Call"**.

Select **"Dial"**.

Or

Select **"Directory"**.

Or

Select **"Calls list"**.

OK

Confirm with **OK**.

SRC /

Press this button for more than two seconds for access to your directory, then navigate using the thumb wheel.

Ending a call

In the **"Telephone"** menu.

Select **"End call"**.

Confirm with **OK** to end the call.

SRC /

During a call, press one of the buttons for more than 2 seconds.



The system accesses the telephone's contacts directory, depending on its compatibility, and while it is connected by Bluetooth



With certain telephones connected by Bluetooth, you can send a contact to the directory of the audio system. Contacts imported in this way are saved in a permanent directory visible to all, whatever the telephone connected.

The menu for the directory is not accessible if it is empty.

Managing calls

OK

During a call, press **OK** to display the contextual menu.

Hang up



In the contextual menu, select "**End call**" to end the call.

OK

Confirm with **OK**.

Microphone off

(so that the caller cannot hear)



In the contextual menu:

- select "**Micro OFF**" to switch off the microphone.
- deselect "**Micro OFF**" to switch the microphone on.

OK

Confirm with **OK**.

Telephone mode



In the contextual menu:

- select "**Telephone mode**" to transfer the call to the telephone (for example, to leave the vehicle while continuing a conversation).
- deselect "**Telephone mode**" to transfer the call to the vehicle.

OK

Confirm with **OK**.

If the contact has been cut off, when you reconnect on returning to the vehicle, the Bluetooth connection will be restored automatically and sound returned to the system (depending on the compatibility of the telephone).

In some cases telephone mode must be activated from the telephone.

Interactive voice response



From the contextual menu, select "**DTMF tones**" and confirm to use the digital keypad to navigate in the interactive voice response menu.

OK

Confirm with **OK**.

Dual call



From the contextual menu, select "**Switch**" and confirm to return to a call left on hold.

OK

Confirm with **OK**.

Directory



The system accesses the telephone's contacts directory, depending on its compatibility, and while it is connected by Bluetooth.



With certain telephones connected by Bluetooth you can send a contact to the directory of the audio system. Contacts imported in this way are saved in a permanent directory visible to all, whatever the telephone connected. The menu for the directory is not accessible if it is empty.



Make a long press on **SRC/TEL**.



Select "**Directory**" to see the list of contacts.

OK

Confirm with **OK**.

MENU

To modify the contacts saved in the system, press **MENU** then select "**Telephone**" and confirm. Select "**Directory management**" and confirm.

You can:

- "**Consult an entry**",
- "**Delete an entry**",
- "**Delete all entries**".

Voice recognition

This function allows you to use your smartphone's voice recognition via the system.

To start voice recognition, depending on the type of steering mounted controls:

Make a long press on the end of the lighting control stalk.

OR



Press this button.



Voice recognition requires the use of a compatible smartphone first connected to the vehicle by Bluetooth.

Frequently asked questions

The table below gives answers to the most frequently asked questions on your audio system.

| QUESTION | ANSWER | SOLUTION |
|--|---|--|
| With the engine off, the audio system switches off after a few minutes of use. | When the engine is switched off, the audio system operating time depends on the state of charge of the battery. The switch-off is normal: the audio equipment switches to economy mode and switches off to prevent discharging of the vehicle's battery. | Start the vehicle's engine to increase the battery charge. |
| The message "the audio system is overheated" appears on the display. | In order to protect the installation if the surrounding temperature is too high, the audio system switches to an automatic thermal protection mode leading to a reduction in volume or CD play stopping. | Switch the audio system off for a few minutes to allow the system to cool. |

Radio

| QUESTION | ANSWER | SOLUTION |
|--|---|--|
| There is a difference in sound quality between the different audio sources (radio, CD...). | For optimum sound quality, the audio settings (Volume, Bass, Treble, Ambience and Loudness) can be adapted to the different sound sources, which may result in audible differences when changing source (radio, CD...). | Check that the audio settings (Volume, Bass, Treble, Ambience and Loudness) are adapted to the sources listened to. It is advisable to set the audio functions (Bass, Treble, Front-Rear Balance and Left-Right Balance) to the middle position, select the musical ambience "None" and set the loudness correction to the "Active" position in CD mode or to the "Inactive" position in radio mode. |

| QUESTION | ANSWER | SOLUTION |
|---|--|--|
| The preset stations do not function (no sound, 87.5 Mhz is displayed...). | An incorrect waveband is selected. | Press the BAND AST button to return to the waveband (FM, FM2, DAB, AM) on which the stations are preset. |
| The traffic announcement (TA) is displayed. I do not receive any traffic information. | The radio station is not part of the regional traffic information network. | Tune to a radio station which broadcasts traffic information. |
| The quality of reception of the radio station listened to gradually deteriorates or the stored stations do not function (no sound, 87.5 Mhz is displayed...). | The vehicle is too far from the transmitter used by the station listened to or there is no transmitter in the geographical area through which the vehicle is travelling. | Activate the RDS function to enable the system to check whether there is a more powerful transmitter in the geographical area. |
| | The environment (hills, buildings, tunnels, underground car parks...) block reception, including in RDS mode. | This phenomenon is normal and does not indicate a fault in the audio system. |
| | The aerial is absent or has been damaged (for example when going through an automatic car wash or into an underground car park). | Have the aerial checked by a franchised dealer. |
| Sound cut-outs of 1 to 2 seconds in radio mode. | During this brief sound cut-out, the RDS searches for another frequency giving better reception of the station. | Deactivate the RDS function if the phenomenon is too frequent and always on the same route. |

Media

| QUESTION | ANSWER | SOLUTION |
|--|---|--|
| The Bluetooth connection is broken. | The state of charge of the device may be too low. | Charge the battery of the portable device. |
| The message "USB device error" is displayed in the screen. | The USB memory stick is not recognised. The USB memory stick may be corrupt. | Reformat the USB memory stick. |
| The CD is ejected every time or is not played. | The CD is upside down, cannot be read, does not contain audio files or contains an audio files of a format that cannot be played by the audio system. The CD is protected by an anti-pirating system not recognised by the audio system. | <ul style="list-style-type: none"> - Check that the CD is inserted in the player the right way up. - Check the condition of the CD: the CD cannot be played if it is too damaged. - Check the content in the case of a recorded CD: consult the advice in the "Audio" section. - Due to their quality level, certain writeable CDs will not be played by the audio system. |
| The sound from the CD is poor. | The CD used is scratched or of poor quality. | Insert a good quality CD and store them in suitable conditions. |
| | The audio settings (base, treble, ambience) are unsuitable. | Return bass and treble settings to 0, without selecting an ambience. |
| I am unable to play the music files on my smartphone via the USB port. | Depending on the smartphone, access by the audio system to music on the smartphone may have to be approved on the latter. | Manual activate the MTP profile on the smartphone (USB settings menu). |

Telephone

| QUESTION | ANSWER | SOLUTION |
|--|---|--|
| I am unable to access my voicemail. | Few telephones or service providers allow the use of this function. | Call your voicemail box, via the telephone menu, using the number supplied by your service provider. |
| I am unable to access my directory of contacts. | Check the compatibility of your telephone. | |
| | You did not give access to your contacts when pairing the telephone. | Accept or confirm access by the system to the contacts on your telephone. |
| I am unable to continue a conversation when getting into my vehicle. | Telephone mode is activated. | Deselect telephone mode to transfer the call to the vehicle. |
| I am unable to pair my telephone by Bluetooth. | Telephones (models, versions of operating systems) have their own specific aspects in the pairing procedure and some telephones are not compatible. | Before starting the pairing procedure, delete the pairing of the telephone from the system AND of the system from the telephone, so as to see the compatibility of the telephones. |

180° rear vision 259

A

ABS 161
 Access, AdBlue tank 285
 Accessories 203, 271, 272
 Access to the spare wheel 297
 Active Safety Brake 23, 243, 246
 AdBlue® 26, 35-37, 283-285
 Additive, AdBlue 26, 35-37, 283-285
 Additive, Diesel 280, 281
 Adjusting headlamp beam height 155
 Adjusting headlamps 155
 Adjusting head restraints 103, 104
 Adjusting seat 99, 102
 Adjusting the air distribution 128
 Adjusting the air flow 128
 Adjusting the date 46, 420, 476
 Adjusting the height and reach of
 the steering wheel 99
 Adjusting the lumbar support 100
 Adjusting the seat belt height 166
 Adjusting the temperature 128
 Adjusting the time 46, 421, 477
 Advice on driving 196-198
 Airbags 24, 170, 177
 Airbags, curtain 173
 Airbags, front 171, 173
 Airbags, lateral 172, 173
 Air conditioning 12, 127, 129, 130, 137
 Air conditioning, automatic 135
 Air conditioning, digital 132, 136

Air conditioning, dual-zone automatic 128
 Air conditioning, manual 126, 132, 135, 136
 Air intake 125, 126, 128, 131
 Alarm 95
 Alarm, volumetric 95
 Anti-lock braking system (ABS) 161
 Anti-theft 52, 67, 205
 Area, loading 47, 55, 73
 Armrest, front 103
 ASR 161
 Assistance call 160, 338
 Assistance, emergency braking 161, 247
 Audio streaming (Bluetooth) 398, 454, 495
 Audio system 89, 150-152, 158,
 226, 245, 247, 250, 256, 264, 483
 Auxiliary 398, 454

B

Battery 270, 281, 321-325
 Battery capacity 325
 Battery, charging 323
 Battery, remote control 54, 70, 71, 139
 Bench seat, one-piece, fixed 110
 Blind spot monitoring system 29, 252, 254
 Blinds, side 123
 BlueHDi 31, 35, 208, 283
 Bluetooth
 (hands-free) 406, 407, 462, 463, 497
 Bluetooth (telephone) 406-408, 462-464
 Bonnet 276

Boot 94
 Boot lid 64, 65, 94, 313, 314
 Brake discs 282
 Brake lamps 310, 311, 313-315
 Brakes 18, 22, 282
 Braking, automatic
 emergency 23, 243, 245-247
 Bulbs (changing) 303, 304, 310, 313
 Bulbs (changing, type) 303

C

Cable, audio 398, 454
 Cable, jack 398, 454
 Capacity, fuel tank 265
 Cap, fuel filler 265
 CarPlay connection 386, 442
 CD 398, 454, 494
 CD, MP3 398, 454, 494
 Central locking 59, 64
 Changing a bulb 303, 304, 310, 311, 313-315
 Changing a bulb (boot lid) 313
 Changing a bulb
 (side-hinged doors) 310
 Changing a fuse 316, 317, 320
 Changing a wheel 296
 Changing a wiper blade 159, 274
 Changing the remote control battery 54, 70
 Checking the engine oil level 34
 Checking the levels 278-280
 Checking tyre pressures
 (using the kit) 290

D

| | |
|--|------------------------------------|
| Checks | 277, 281, 282 |
| Checks, routine | 281, 282 |
| Child lock | 194, 195 |
| Child lock, electric | 194 |
| Child lock on rear windows | 195 |
| Children | 182, 187, 188, 190 |
| Children (safety) | 194 |
| Child seats | 169, 174-176, 180-182, 184, 193 |
| Child seats, conventional | 180-182, 184 |
| Child seats, ISOFIX | 187, 188, 190 |
| CITROËN Connect Box | 338 |
| CITROËN Connect Nav | 341 |
| CITROËN Connect Radio | 429 |
| CITROËN Localised Emergency Call | 338 |
| Closing the boot | 94 |
| Closing the doors ... | 59, 64, 74, 75, 77, 82, 91, 93 |
| Collision risk alert | 23, 243-245, 247 |
| Compressor, tyre inflation | 290 |
| Connection, Bluetooth | 380, 406-408, 436, 462-464, 498 |
| Connection, MirrorLink | 382, 384, 438, 440 |
| Connection, Wi-Fi network | 381, 437 |
| Connectivity | 378, 434 |
| Control, emergency boot release | 94 |
| Control, emergency door | 53, 68 |
| Control, heated seats | 103, 105 |
| Control stalk, lighting | 30, 146 |
| Control stalk, wipers | 156, 157 |
| Courtesy lamp | 312 |
| Courtesy lamp, front | 141, 142, 312, 315 |
| Courtesy lamp, rear | 141, 142, 312, 315 |
| Courtesy lamps | 141, 142, 312, 315 |
| Cover, load space | 123 |
| Crew cab, fixed | 117 |
| Cruise control | 224, 227, 232, 233, 237 |
| Cruise control, adaptive | 227, 236 |
| Cruise control by speed limit recognition | 227 |

| | |
|---|--------------------------------------|
| DAB (Digital Audio Broadcasting) - Digital radio | 396, 397, 452, 453, 490, 491 |
| Date (setting) | 46, 420, 476 |
| Daytime running lamps | 146, 149, 304-306 |
| Deactivating the passenger airbag | 171, 177 |
| Deactivation of DSC (ESC) | 163 |
| Deadlocking | 51, 58, 65 |
| Defrosting | 132, 144 |
| Demisting | 132 |
| Demisting, rear | 133, 134 |
| Demisting, rear screen | 133, 134 |
| Diagnostic system, engine | 21 |
| Dial | 15, 16 |
| Dials and gauges | 14 |
| Dimensions | 328-330 |
| Dipstick | 34, 278 |
| Direction indicators | 148, 304, 307, 308, 310, 313, 315 |
| Display, head-up | 222 |
| Display screen, instrument panel | 14-16, 208 |
| Door pockets | 120 |
| Doors | 74 |
| Doors, rear | 91 |
| Doors, side-hinged | 64, 65, 91-93, 310, 311 |
| Driver's door open warning | 75 |
| Driver's fatigue warning | 250, 251 |
| Driving abroad | 148 |
| Driving economically | 12 |
| Driving time warning | 250, 251 |
| DSC | 161 |
| Dynamic stability control (DSC) | 25, 161, 163, 164 |

E

| | |
|---|----------------------------------|
| EBA | 161 |
| EBFD | 161 |
| Eco-driving (advice) | 12 |
| Economy mode | 270 |
| Electric windows | 98 |
| Electronic brake force distribution (EBFD) | 161 |
| Emergency call | 160, 338 |
| Emergency warning lamps | 160, 287 |
| Emissions control system, SCR | 27 |
| Energy economy mode | 270 |
| Engine compartment | 277 |
| Engine, Diesel | 21, 267, 277, 327, 333, 335, 336 |
| Environment | 12, 54, 70, 139 |
| ESC/ASR | 161 |
| ESC (electronic stability control) | 25 |
| ESC system | 25 |

F

| | |
|-------------------------------------|----------|
| Fatigue detection | 250, 251 |
| Filling the fuel tank | 265, 267 |
| Filter, air | 281 |
| Filter, oil | 281 |
| Filter, particle | 280, 281 |
| Filter, passenger compartment | 281 |
| Finisher | 302 |
| Fitting a wheel | 299 |
| Fitting roof bars | 273 |
| Fittings, interior | 120, 123 |
| Fittings, rear | 123 |
| Fitting the mat | 119 |

| | |
|----------------------------------|--------------------|
| Flap, fuel filler..... | 265 |
| Flap, removable..... | 106 |
| Flashing indicators..... | 148 |
| Foglamp, rear..... | 147, 310, 313, 315 |
| Foglamps..... | 304 |
| Foglamps, front..... | 147, 152, 304, 309 |
| Foglamps, rear..... | 147 |
| Frequency (radio)..... | 395, 451 |
| Fuel..... | 12, 267 |
| Fuel consumption..... | 12, 42 |
| Fuel tank..... | 20 |
| Fusebox, engine compartment..... | 320 |
| Fuses..... | 316, 317, 320 |

G

| | |
|-------------------------------------|--|
| Gauge, fuel..... | 265 |
| Gearbox, automatic..... | 12, 14-16, 21, 199, 204, 206, 209, 218, 219, 233, 237, 282, 321 |
| Gearbox, electronic..... | 12, 14-16, 202, 206, 214, 218, 219, 282 |
| Gearbox, manual..... | 12, 14-16, 21, 206, 207, 218, 219, 233, 237, 282 |
| Gear efficiency indicator..... | 208 |
| Gear lever..... | 12 |
| Gear lever, automatic gearbox..... | 209 |
| Gear lever, electronic gearbox..... | 282 |
| Gear lever, manual gearbox..... | 207 |
| Glove box..... | 120 |
| G.P.S..... | 366 |
| Grip control..... | 164 |
| Guide-me-home..... | 150 |

H

| | |
|---|------------------------|
| Hazard warning lamps..... | 160, 287 |
| Hazard warning lamps, automatic operation..... | 160 |
| Headlamp adjustment..... | 155 |
| Headlamp adjustment..... | 155 |
| Headlamp beam height..... | 155 |
| Headlamp dipping, automatic..... | 154 |
| Headlamps, automatic dipping..... | 29, 153 |
| Headlamps, automatic illumination..... | 146, 149, 150 |
| Headlamps, dipped beam..... | 29, 146, 304, 306, 308 |
| Headlamps, halogen..... | 304, 306 |
| Headlamps, main beam..... | 29, 146, 304, 307, 308 |
| Headlamps, Xenon..... | 304, 308 |
| Headlamp wash..... | 158 |
| Head restraints, front..... | 103, 104 |
| Head-up display..... | 222, 223, 244 |
| Heated bench seat..... | 105 |
| Heating..... | 12, 125, 126, 135-138 |
| Heating, additional..... | 95, 138 |
| Heating, programmable..... | 95, 138 |
| Hill start assist..... | 206 |
| Horn..... | 161 |

I

| | |
|-------------------------------|--------------------|
| Identification, vehicle..... | 337 |
| Ignition..... | 201, 203, 410, 466 |
| Ignition on..... | 203 |
| Immobiliser, electronic..... | 52, 67, 71, 205 |
| Indicator, AdBlue® range..... | 35 |

J

| | |
|-----------|--------------------|
| Jack..... | 122, 296, 398, 454 |
|-----------|--------------------|

K

| | |
|---------------------------------|--|
| Key..... | 47-50, 71, 74, 75, 199 |
| Key, electronic..... | 47, 204 |
| Keyless Entry and Starting..... | 55, 59, 60, 63-65, 68, 70, 71, 74, 75, 202, 205 |
| Key with remote control..... | 50, 64, 199, 205 |
| Kit, hands-free..... | 406, 407, 462, 463, 497 |

Kit, puncture repair290
 Kit, temporary puncture repair 289, 290

L

Labels 11, 116
 Labels, identification337
 Ladder272
 Lane Departure Warning
 System (LDWS)29, 248, 249
 Level, brake fluid279
 Level, Diesel additive280, 281
 Level, engine coolant31, 279
 Level, engine oil34, 278
 Level, headlamp wash158, 280
 Level, power steering fluid279
 Levels and checks277-280
 Level, screenwash fluid158, 280
 Lighting30, 146
 Lighting, cornering152
 Lighting dimmer39
 Lighting, guide-me home150
 Lighting, welcome151
 Loading12, 273
 Loading area fittings122
 Load reduction mode270
 Load restraint122
 Localised Assistance Call338
 Locating your vehicle52, 67
 Locking50, 55, 57, 64, 71
 Locking from the inside72, 73
 Low fuel level20, 265
 Lumbar100

M

Maintenance, routine12
 Markings, identification337
 Mat119, 202
 Memorising a speed224
 Menu352, 354, 356, 358, 360, 362,
 370, 372, 374, 378, 384, 386, 388, 390, 392,
 400, 402, 404, 412, 414, 416, 434, 440, 442,
 444, 446, 448, 456, 458, 460, 468, 470, 472
 Menu, main487
 Menus (audio)345, 433
 Messages410, 466
 Messages, quick411, 467
 Mirror, rear view145
 Mirrors, door133, 134, 143, 144, 252
 Mirror, vanity119
 Misfuel prevention266
 Moduwork106
 Mountings, Isofix186, 190
 MP3 CD494

N

Navigation352, 354, 356, 358, 360, 362
 Navigation, connected370, 372, 374
 Net, cargo106
 Net, high load retaining123
 Number plate lamps311, 314

O

Oil change278
 Oil consumption278
 Oil, engine278
 On-board tools287, 289
 Opening the bonnet276
 Opening the boot47, 59, 94
 Opening the doors47, 59, 74, 78-81, 83, 93
 Opening to 90/180/235°92
 Opening to 180°91

P

Pads, brake282
 Paint colour code337
 Parking brake18, 205, 282
 Parking sensors, audible
 and visual256
 Parking sensors, front256
 Parking sensors, rear255, 256
 Plates, identification337
 Platform cab315, 332
 Player, Apple®399, 455, 495
 Player, MP3 CD494
 Player, USB398, 454, 492
 Port, USB122, 398, 454, 492
 Pressures, tyres290, 295, 302, 337
 Pre-tensioning seat belts169
 Priming pump327
 Priming the fuel system327
 Profiles418, 474
 Protecting children171, 174-176,
 182, 187, 188, 190, 193
 Puncture290

R

| | |
|---|--------------------------------------|
| Radio..... | 394, 398, 450, 454, 488, 489 |
| Radio, digital (Digital Audio Broadcasting - DAB)..... | 396, 397, 452, 453 |
| Radio Media..... | 388, 390, 392, 444, 446, 448 |
| Range..... | 42 |
| Range, AdBlue..... | 35 |
| RDS..... | 395, 451 |
| Rear screen, demisting..... | 133, 134 |
| Recharging the battery..... | 323 |
| Recirculation, air..... | 125, 126, 128, 131 |
| Reduction of electrical load..... | 270 |
| Regeneration of the particle filter..... | 281 |
| Reinitialisation of the under-inflation detection system..... | 263 |
| Reinitialising the remote control..... | 54, 70 |
| Reminder, key in ignition..... | 201 |
| Reminder, lighting on..... | 148 |
| Remote control..... | 47-50, 52, 55-59, 67, 68, 71, 74, 75 |
| Removing a wheel..... | 299 |
| Removing the mat..... | 119 |
| Replacing bulbs..... | 303, 304, 310, 311, 313-315 |
| Replacing fuses..... | 316, 317 |
| Replacing the air filter..... | 281 |
| Replacing the oil filter..... | 281 |
| Replacing the passenger compartment filter..... | 281 |
| Reservoir, headlamp wash..... | 280 |
| Reservoir, screenwash..... | 280 |
| Reset journey..... | 41 |
| Resetting the service indicator..... | 33 |
| Resetting the trip recorder..... | 38 |
| Rev counter..... | 14-16 |
| Reversing camera..... | 259 |
| Reversing camera (on interior mirror)..... | 258 |
| Reversing lamp..... | 310, 313, 315 |
| Roof bars..... | 272, 273 |

| | |
|-----------------------------------|----------|
| Roof rack..... | 272, 273 |
| Running out of fuel (Diesel)..... | 327 |

S

| | |
|---|---|
| Safety, children..... | 171, 174-176, 182, 187, 188, 190, 193 |
| Saturation of the particle filter (Diesel)..... | 281 |
| Screen, instrument panel..... | 40, 41 |
| Screen menu map..... | 352, 354, 356, 358, 360, 362, 370, 372, 374, 378, 384, 386, 388, 390, 392, 400, 402, 404, 412, 414, 416, 434, 440, 442, 444, 446, 448, 456, 458, 460, 468, 470, 472 |
| Screen, multifunction (with audio system)..... | 487 |
| Screenwash..... | 158 |
| Screenwash, rear..... | 157 |
| SCR (Selective Catalytic Reduction)..... | 283 |
| SCR system..... | 283 |
| Seat and bench seat, rear, fixed..... | 113, 116 |
| Seat and bench seat, rear, on rails..... | 116 |
| Seat belts..... | 166, 168, 169, 180, 181 |
| Seat belts, rear..... | 167 |
| Seat, front bench, 2-seat..... | 104, 167 |
| Seat, rear bench..... | 116 |
| Seats, electric..... | 102 |

| | |
|---------------------------------------|------------------------------|
| Seats, front..... | 99, 101, 102 |
| Seats, front bench..... | 105 |
| Seats, heated..... | 103, 105 |
| Seats, rear..... | 110, 113 |
| Selector, gear..... | 214 |
| Serial number, vehicle..... | 337 |
| Service..... | 28 |
| Service indicator..... | 31, 33 |
| Service (warning lamp)..... | 28 |
| Servicing..... | 12 |
| Settings..... | 412, 414, 416, 468, 470, 472 |
| Settings, system..... | 420, 476 |
| Sidelamps..... | 146, 304-306, 310, 313, 315 |
| Side repeater..... | 305 |
| Sliding side door, electric..... | 49, 57, 64, 65, 78-84 |
| Sliding side door, hands-free..... | 87, 89, 90 |
| Sliding side door, manual..... | 75-77 |
| Sliding side window..... | 124 |
| Snow chains..... | 262, 268 |
| Snow chains, link..... | 268 |
| Socket, 12 V accessory..... | 121 |
| Socket, auxiliary..... | 398, 454, 494 |
| Socket, JACK..... | 122, 398, 454, 494 |
| Sockets, audio..... | 122 |
| Speed limiter..... | 224, 227, 229 |
| Speed limit recognition..... | 225, 226, 229, 232, 236 |
| Speedometer..... | 14-16 |
| Stability control (ESC)..... | 25, 161 |
| Starting the engine..... | 199 |
| Starting the vehicle..... | 202, 204, 206, 209, 214 |
| Station, radio..... | 394, 395, 450, 451 |
| Stay, bonnet..... | 276 |
| Steering mounted controls, audio..... | 344, 432, 485, 486 |
| Steering wheel, adjustment..... | 99 |
| Stop..... | 18 |

Stopping the vehicle 202, 204, 209, 214
 Stop & Start.....22, 29, 42, 132,
 135, 218, 220, 265, 276, 281, 321, 324
 Stop (warning lamp)..... 18
 Storage..... 105, 109, 117, 120
 Storage compartments 120, 121
 Storage wells117, 120
 Stowing rings 122
 Sun visor 119
 Switching off the engine199
 Synchronising the remote
 control.....54, 70

T

Table of weights 333, 335, 336
 Table position.....101
 Tables of fuses 316, 317, 320
 Table top, working..... 109
 Tank, fuel.....265
 Technical data 333, 335, 336
 Telephone 400, 402, 404, 406-411,
 456, 458, 460, 462-467, 497, 498, 500
 Telephone, Bluetooth with
 voice recognition501
 Temperature, coolant..... 19, 31
 Third brake lamp 311, 314
 Three flashes
 (direction indicators)..... 148
 Time (setting).....46, 421, 477
 TMC (Traffic info)367
 Tool box.....287, 289, 290, 296

Tools..... 290, 296
 Topping-up the AdBlue®
 additive285
 Total distance recorder.....38
 Touch screen.....39, 43, 44,
 89, 150-152, 154, 158, 220, 226, 236, 245,
 247, 249, 250, 254, 256, 264, 341, 429
 Towbar..... 198, 269, 272
 Towed loads 333, 335, 336
 Towing another vehicle.....325, 326
 Towing eye325
 Traction control (ASR) 25, 161
 Traffic information (TA).....489
 Traffic information (TMC).....367
 Trailer198, 269
 Triangle, warning.....287
 Trip computer..... 40-42
 Trip distance recorder38
 Type of bulbs.....303
 Tyres..... 12
 Tyre under-inflation
 detection 22, 262, 264, 295, 302

U

Under-inflation
 (detection)262
 Unlocking47-49, 55-57, 59, 60, 63
 Unlocking from
 the inside 72, 73, 79-81, 83
 Unlocking, selective.....47, 49, 55, 56, 60

Unlocking the doors80, 81, 83
 Unlocking, total47, 55, 60
 Updating the date.....46, 420, 476
 Updating the time.....46, 421, 477
 USB 122, 398, 454

V

Ventilation 12, 125, 126, 131, 135, 136
 Voice commands 346-351

W

Warning and indicator lamps 17
 Warning lamp, braking
 system..... 18
 Warning lamp, Diesel engine
 pre-heater21
 Warning lamp, door(s) open20
 Warning lamp, driver's seat belt not
 fastened168
 Warning lamps 17
 Warning lamp, SCR emissions
 control system27

| | |
|---|-------------------------|
| Warning lamp, seat belts | 168 |
| Warning lamp, Service..... | 28 |
| Warning lamp, Stop | 18 |
| Warning lamp, water in Diesel filter | 20 |
| Washer jets, heated | 132, 159 |
| Weights | 332, 333, 335, 336 |
| Welcome lighting..... | 52, 67 |
| Wheel, spare | 262, 289, 296, 297, 302 |
| Windows, rear | 123, 124 |
| Windscreen, heated..... | 132, 159 |
| Wiper blades (changing) | 159, 274 |
| Wiper, rear..... | 157, 158 |
| Wipers | 29, 156, 157 |
| Wipers, automatic rain sensitive..... | 156, 157 |



| | |
|--------------------------|---|
| BG (български) | Съдържа флуорсъдържащи парникови газове R134A. |
| CS (čeština) | Obsahuje fluorované skleníkové plyny R134A. |
| DA (dansk) | Indeholder fluorholdige drivhusgasser R134A. |
| DE (deutsch) | Enthält fluorierte Treibhausgase R134A. |
| EL (ελληνικά) | Περιέχει φθοριούχα αέρια του θερμοκηπίου R134A. |
| EN (english) | Contains fluorinated greenhouse gases R134A. |
| ES (español) | Contiene gases fluorados de efecto invernadero R134A. |
| ET (eesti) | Sisaldab fluoritud kasvuhoonegaase R134A. |
| FI (suomi) | Sisältää fluorattuja kasvihuonekaasuja R134A. |
| FR (français) | Contient des gaz à effet de serre fluorés R134A. |
| GA (Gaeilge) | Tá gáis cheaptha teasa fhluaírinithe R134A. |
| HR (hrvatski) | Sadržava fluorirane stakleničke plinove R134A. |
| HU (magyar) | Fluortartalmú üvegházhatású gázokat tartalmaz R134A. |
| IS (islenska) | Inniheldur flúoraðar gróðurhúsalofttegundir R134A. |



| | |
|---------------------------------|---|
| IT (italiano) | Contiene gas fluorurati a effetto serra R134A. |
| LB (Lëtzebuergesch) | Enthält Fluorgase mat Treibhauseffekt R134A. |
| LT (lietuvių) | sudėtyje yra fluorintų šiltnamio efektą sukeliančių dujų R134A. |
| LV (latviešu) | Satur fluorētas siltumnīcefekta gāzes R134A. |
| MT (Malti) | Fih gassijiet fluworurati b'effett ta' serra R134A. |
| NL (nederlands) | Bevat gefluoreerde broeikasgassen R134A. |
| NV (norsk) | Inneholder klimagasser R134A. |
| PL (polski) | Zawiera fluorowane gazy cieplarniane R134A. |
| PT (português) | Contém gases fluorados com efeito de estufa R134A. |
| RO (română) | Conține gaze fluorurate cu efect de seră R134A. |
| SK (slovenska izdaja) | Obsahuje fluórované skleníkové plyny R134A. |
| SL (slovenčina) | Vsebuje fluorirane toplogredne pline R134A. |
| SV (svenska) | Innehåller fluorerade växthusgaser R134A. |
| TR (türkçe) | Fluorlu sera gazı içerir R134A. |

Labels are applied at various points on your vehicle. They carry safety warnings as well as vehicle identification information. Do not remove them: they form an integral part of your vehicle.

Automobiles CITROËN declares, by application of the provisions of the European legislation (Directive 2000/53) relating to End of Life Vehicles, that it achieves the objectives set by this legislation and that recycled materials are used in the manufacture of the products that it sells.

Reproduction or translation of all or part of this document is prohibited without written authorisation from Automobiles CITROËN.

For any work on your vehicle, use a qualified workshop that has the technical information, skills and equipment required, all of which a CITROËN dealer is able to provide.

We draw your attention to the following points:

- The fitting of electrical equipment or accessories not listed by CITROËN may cause faults and failures with the electrical system of your vehicle. Contact a CITROËN dealer for information on the range of recommended accessories.
- As a safety measure, access to the diagnostic socket, used for the vehicle's electronic systems, is reserved strictly for CITROËN dealers or qualified workshops, equipped with the special tools required (risk of malfunctions of the vehicle's electronic systems that could cause breakdowns or serious accidents). The manufacturer cannot be held responsible if this advice is not followed.
- Any modification or adaptation not intended or authorised by Automobiles CITROËN or carried out without meeting the technical requirements defined by the manufacturer would lead to the suspension of the legal and contractual warranties.





CITROËN Connect Radio

Multimedia audio system - Applications - Bluetooth® telephone



| | Contents |
|------------------------------------|----------|
| First steps | 96 |
| Steering mounted controls - Type 1 | 98 |
| Steering mounted controls - Type 2 | 99 |
| Menus | 100 |
| Applications | 102 |
| Radio Media | 106 |
| Telephone | 118 |
| Settings | 132 |
| Frequently asked questions | 143 |

i The different functions and settings described vary according to the version and configuration of your vehicle.

! As a safety measure and because it requires sustained attention by the driver, the pairing of a Bluetooth mobile telephone with the Bluetooth hands-free system of your audio system must be done with the **vehicle stationary** and the ignition on.

i The system is protected in such a way that it will only operate in your vehicle. The display of the **Energy Economy Mode** message signals that a change to standby is imminent.

i The link below gives access to OSS (Open Source Software) codes for the system.
<http://www.psa-peugeot-citroen.com/oss>

First steps



With the engine running, a press mutes the sound.
With the ignition off, a press turns the system on.



Volume.

Use the buttons either side of or below the touch screen for access to the menus, then press the virtual buttons in the touch screen. All of the touch areas of the screen are white. Press in the grey zone to go back a level or confirm.
Press the back arrow to go back a level or confirm.



The touch screen is of the "capacitive" type.
To clean the screen, use a soft, non-abrasive cloth (spectacles cloth) with no additional product.
Do not use sharp objects on the screen.
Do not touch the screen with wet hands.

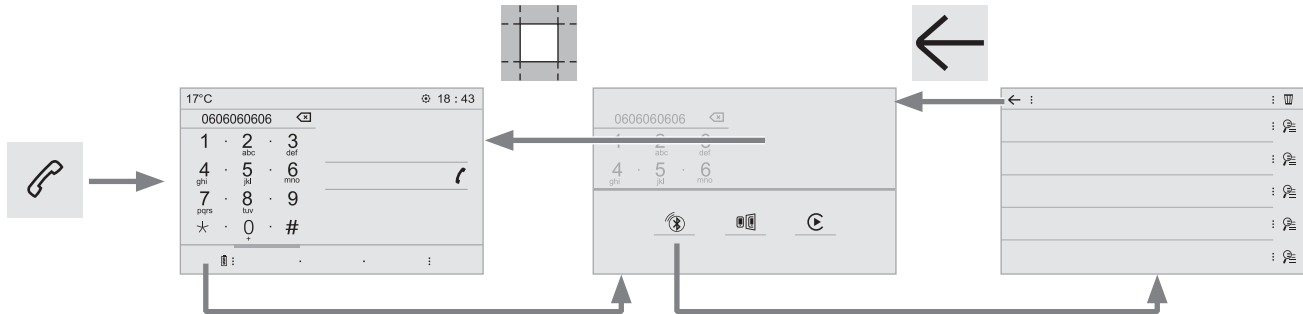

Certain information is displayed permanently in the upper band of the touch screen:

- Reminder of the air conditioning information, and direct access to the corresponding menu.
- Reminder of the Radio Media and Telephone menu information.
- Access to the Settings of the touch screen and digital instrument panel.

Select the audio source (depending on version):

- FM / DAB* / AM* stations.
- Telephone connected by Bluetooth* and using Bluetooth* audio streaming.
- CD player.
- USB memory stick.
- Media player connected to the auxiliary socket (Jack, cable not supplied).

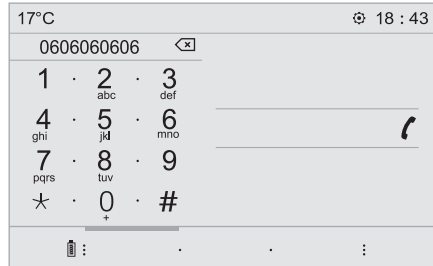

In the "Settings" menu you can create a profile for just one person or a group of people with common points, with the possibility of entering a multitude of settings (radio presets, audio settings, ambiences, ...); these settings are taken into account automatically.

In very hot conditions, the volume may be limited to protect the system. It may go into standby (screen and sound off) for at least 5 minutes. The return to normal takes place when the temperature in the passenger compartment has dropped.

* Depending on equipment.

Steering mounted controls - Type 1



Radio:

Select the previous / next preset radio station.

Select the previous / next item in a menu or a list.

Media:

Select of the previous / next track

Select the previous / next item in a menu or a list.



Radio:

Short press: display the list of radio stations.

Long press: update the list.

Media:

Short press: display the list of folders.

Long press: display the sorting options.



Change audio source (Radio; USB; AUX (if a device is connected); CD; Streaming)



Confirm a selection.



Increase volume.



Decrease volume.



Mute / Restore sound by simultaneously pressing the increase and decrease volume buttons.



Steering mounted controls - Type 2



Voice commands:

Short press, smartphone voice commands via the system.



Increase volume.



Decrease volume.



Mute/ Restore the sound.
Or

Mute by pressing the volume increase and decrease buttons simultaneously.

Restore the sound by pressing one of the two volume buttons.



Media (short press): change the multimedia source.

Telephone (short press): call.

Call in progress (short press): access to telephone menu.



Telephone (long press): reject an incoming call, end call, access to telephone menu.



Radio (rotate): previous / next preset.

Media (rotate): previous / next track, move in a list.

Short press: confirm a selection; other than selection, access to presets.



Radio: display the list of stations.

Media: display the list of tracks.

Radio (press and hold): update the list of stations received.

Menus

According to version.

Air conditioning

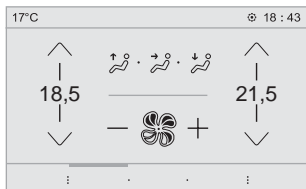

Manage the different temperature and air flow settings.

Applications

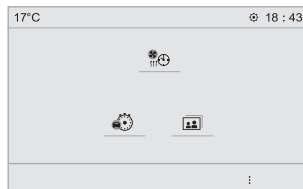

Access configurable equipment.

Radio Media

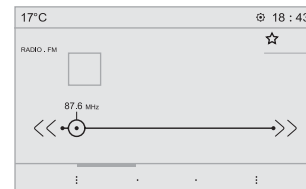

Select an audio source or radio station.

Navigation

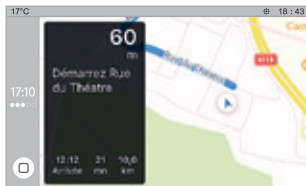

Configure the guidance and select your destination via MirrorLink™ or CarPlay®.



Telephone



Connect a telephone by Bluetooth®.
Operate certain applications on a smartphone connected via MirrorLink™ or CarPlay®.



Settings

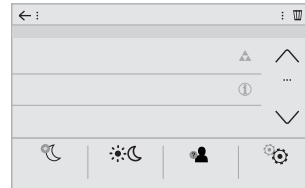

Configure a personal profile and/or configure the sound (balance, ambience, ...) and the display (language, units, date, time, ...).



Driving









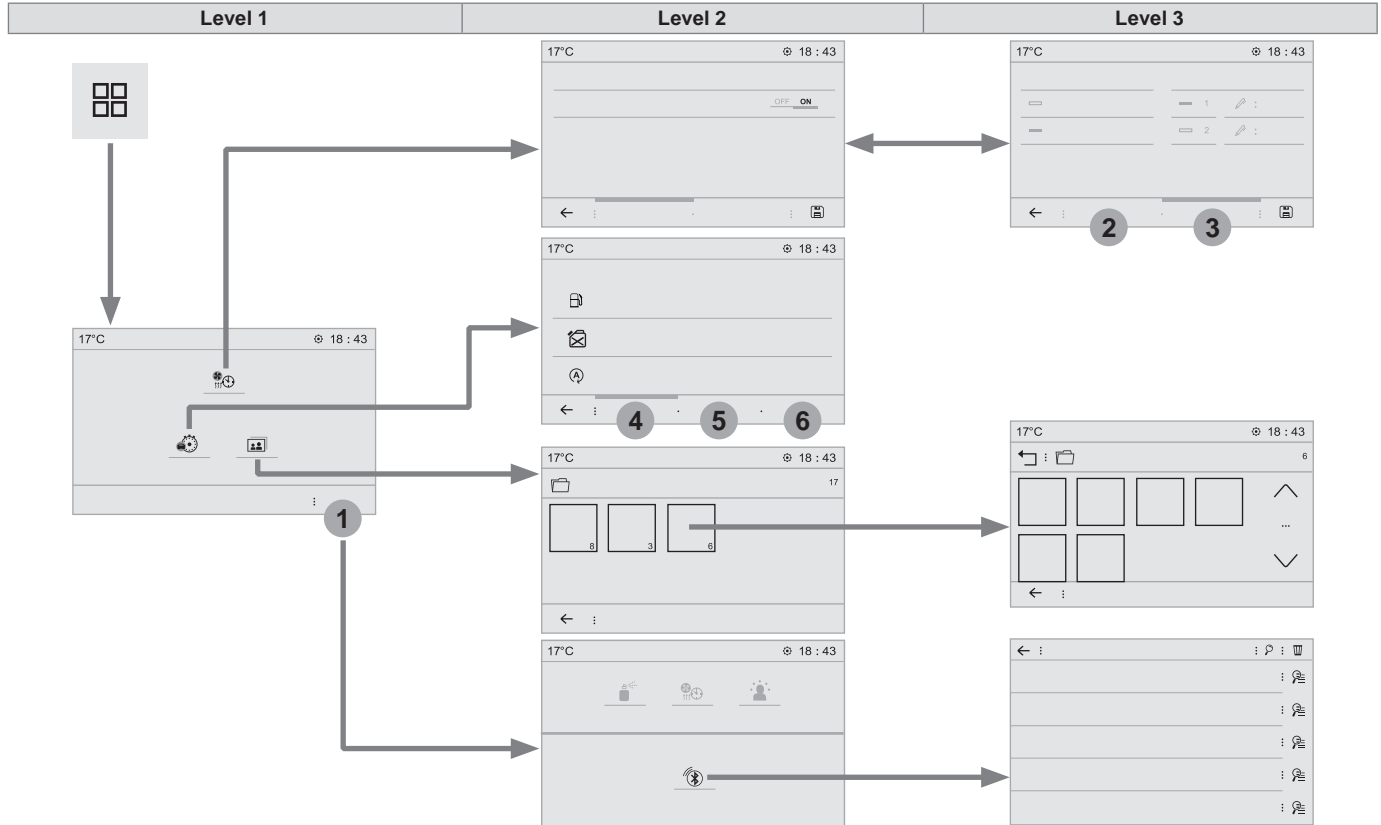









Activate, deactivate or configure certain vehicle functions.

Applications

According to version / according to equipment



| Level 1 | | Level 2 | | Level 3 | | Comments |
|--|---|---|-----------------------------|---|---------------|---|
|   | Applications ↓ Temperature conditioning | 2 | State | | | Activate / deactivate the temperature conditioning. |
| | | 3 | Settings | | | Configure the pre-conditioning. |
| | |  | | | | Save the parameters. |
| | |  | | | | Confirm the settings. |
|   | Applications ↓ Trip computer | 4 | Instant | | | System providing information about the current journey (range, consumption...). |
| | | 5 | Trip 1 | | | |
| | | 6 | Trip 2 | | | |
| | |  | | | | Go back to the Applications page. |
|   | Applications ↓ Photos |  | Photo gallery |  | Photos | Go to the photo gallery. |
| | | | |  | | Go back a level. |
|  1 | Applications ↓ OPTIONS |  | Bluetooth connection |  | Search | Start the search for a device to be connected. |
| | | | |  | Delete | Delete one or more devices. |

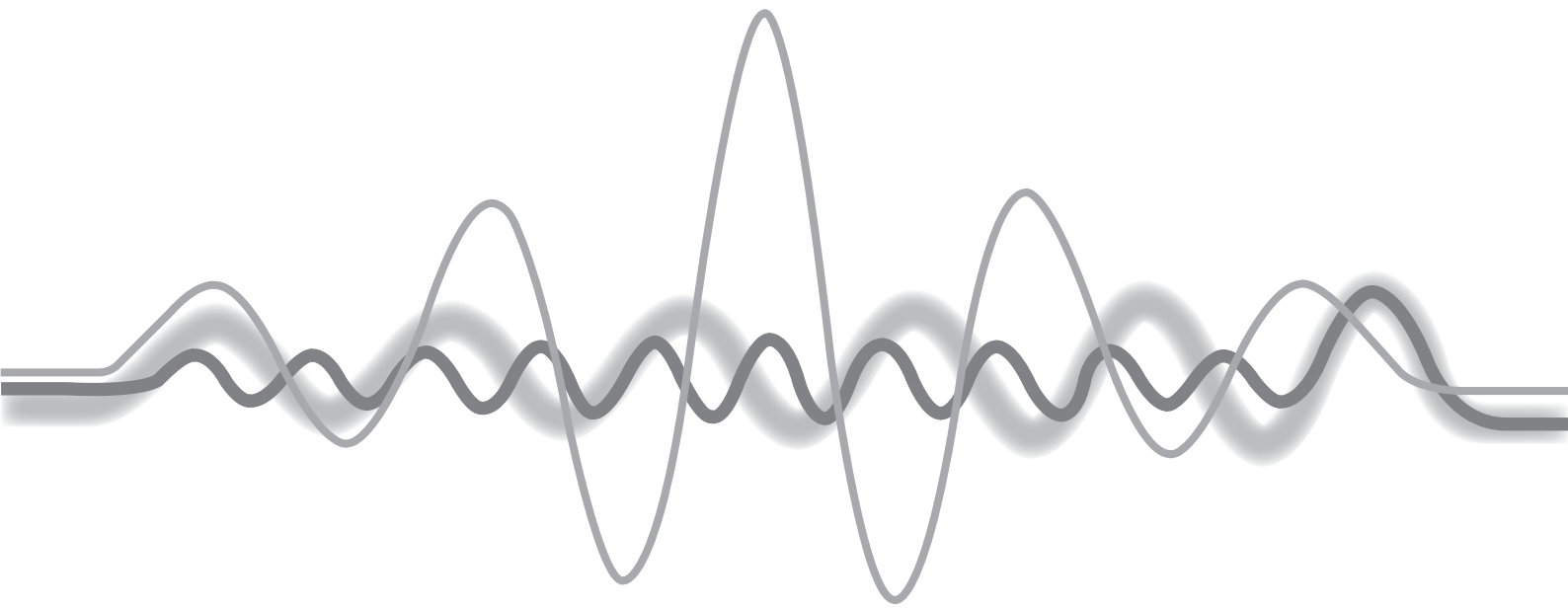

Viewing photos

Insert a USB memory stick in the USB port.

 To protect the system, do not use a USB hub.

The system can read folders and image files in the formats: .tiff; .gif; .jpg/jpeg; .bmp; .png.



Press **Applications** to display the primary page.



Press "**Photos**".



Select a folder.

























Select an image to view.











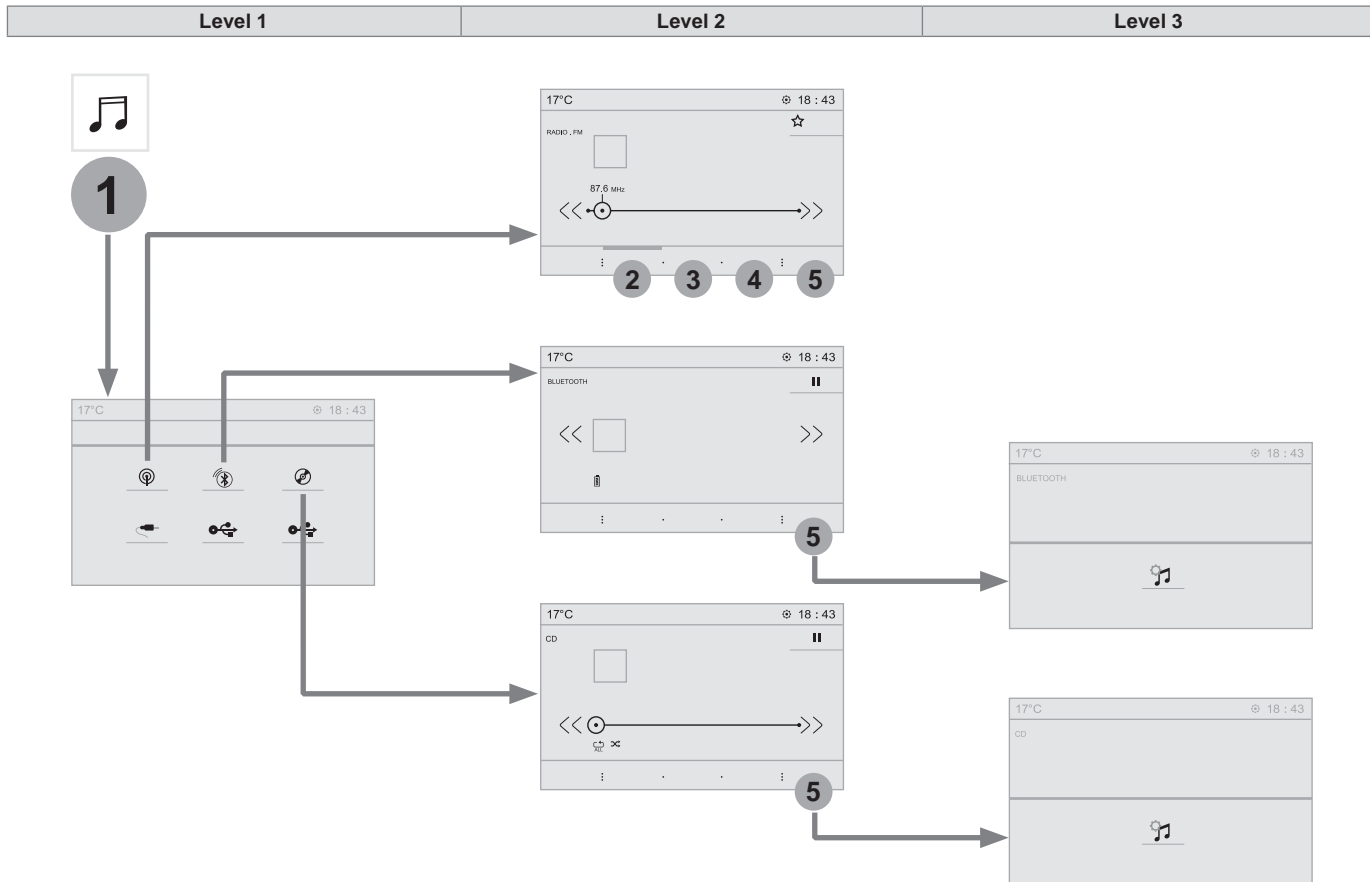

Press this button to display the details of the photo.







Press the back arrow to go back a level.

| Level 1 | | Level 2 | | Comments |
|---|--------------------------------------|---|----------------------|---|
|  1 | Radio Media ↓ SOURCES |  Radio | | Select change of source. |
| | |  Bluetooth | | |
| | |  CD | | |
| | |  AUX | | |
| | |  USB  iPod | | |
|  2 | Radio Media ↓ Frequency | | FM / DAB / AM | Display the current radio station. |
|  3 | Radio Media ↓ List |  | | Update the list according to the stations received. |
| | |  Preset | | Make a short press to preset the station. |
|  4 | Radio Media ↓ Preset |  | | Select a preset station or preset a station. |
|  5 | Radio Media ↓ OPTIONS |  AM band / DAB band / FM band | | Press the Band button to change waveband. |
| | |  Audio settings | | Configure the audio settings. |
| | |  News | | Activate or deactivate the options. |
| | |  TA | | |
| | |  RDS | | |
|  FM-DAB Follow-up | | | | |
|  MHz KHz | Radio Media ↓ 87.5 MHz |  | | Enter a frequency of the FM and AM bands on the virtual keypad. |



| Level 1 | | Level 2 | | Level 3 | | Comments | |
|--|---|----------|-----------|---|------------------------------|--|---------------------------------------|
|  1  | Radio Media ↓ SOURCES ↓ Radio | 2 | Frequency | | | Display the current radio station. | |
| | | 3 | List | | | Display the list of stations received. | |
| | | 4 | Preset | | | Select a preset station or preset a station. | |
| | | 5 | OPTIONS |  | FM band / DAB band / AM band | | Press the band button to change band. |
| | | | |  | Audio settings | | Configure the audio settings. |
| | | | | <input checked="" type="checkbox"/> | News | | Activate or deactivate the options. |
| <input checked="" type="checkbox"/> | TA | | | | | | |
| <input checked="" type="checkbox"/> | RDS | | | | | | |
| <input checked="" type="checkbox"/> | FM-DAB Follow-up | | | | | | |
|  1  | Radio Media ↓ SOURCES ↓ Bluetooth | 5 | OPTIONS |  | Audio settings | Configure the audio settings. | |
|  1  | Radio Media ↓ SOURCES ↓ CD | | | | | Display the details of the music being played. | |
| | | 5 | OPTIONS |  | Audio settings | Configure the audio settings. | |

| Level 1 | | Level 2 | | Level 3 | | Comments |
|---|--|----------|-------------|---|----------------|--|
|  | Radio Media ↓ SOURCES ↓ AUX | 5 | OPTIONS |  | Audio settings | Configure the audio settings. |
|  | Radio Media ↓ SOURCES ↓ USB | 6 | Player | | | Display the details of the music being played. |
| 1 | | 7 | Tracks list | | | Display the current selection. |
|  | | 8 | Library | | | Display the music library. |
| | | 5 | OPTIONS |  | Audio settings | Configure the audio settings. |

Radio

Selecting a station



Press **Radio Media** to display the menu.



Press one of the buttons for an automatic search for radio stations.

Or



Move the cursor for a manual search for frequencies up or down.

Or



Press the frequency.



Enter the FM and AM waveband values using the virtual keypad.



Press "**OK**" to confirm.



Radio reception may be affected by the use of electrical equipment not approved by the Brand, such as a USB charger connected to the 12V socket. The exterior environment (hills, buildings, tunnel, car park, below ground...) may prevent reception, even in RDS station tracking mode. This phenomenon is normal in the propagation of radio waves and is in no way indicative of a fault with the audio system.

Changing waveband



Press **Radio Media** to display the primary page.



Press the "**OPTIONS**" button to go to the secondary page.



Press "**Band**" to change waveband.



Press in the grey zone to confirm.

Preset a station

Select a radio station or frequency.



Make a short press on the star outline. If the star is solid, the radio station is already preset.

Or

Select a radio station or frequency.



Press "**Preset**".



Make a long press on one of the buttons to preset the station.

Activate/ Deactivate RDS



Press **Radio Media** to display the primary page.

5

Press the "**OPTIONS**" button to go to the secondary page.



Activate/deactivate "**RDS**".



Press in the grey zone to confirm.

i RDS, if activated, allows you to continue listening to the same station by automatic retuning to alternative frequencies. However, in certain conditions, coverage of an RDS station may not be assured throughout the entire country as radio stations do not cover 100 % of the territory. This explains the loss of reception of the station during a journey.

Display text information



The "Radio Text" function allows information transmitted by the radio station and related to the station or the song playing to be displayed.



Press **Radio Media** to display the primary page.

5

Press the "**OPTIONS**" button to go to the secondary page.



Activate / Deactivate "**NEWS**".



Press in the grey zone to confirm.

Play TA messages



The TA (Traffic Announcement) function gives priority to TAalert messages. To operate, this function needs good reception of a radio station that carries this type of message. While traffic information is being broadcast, the current media is automatically interrupted so that the TA message can be heard. Normal play of the media previously playing is resumed at the end of the message.



Press **Radio Media** to display the primary page.

5

Press the "**OPTIONS**" button to go to the secondary page.



Activate / Deactivate "**TA**".



Press in the grey zone to confirm.

Audio settings



Press **Radio Media** to display the primary page.



Press the "**OPTIONS**" button to go to the secondary page.



Press "**Audio settings**".



Select the "**Tone**" or "**Balance**" or "**Sound**" or "**Ringtones**" tab to configure the audio settings.



Press the back arrow to confirm.

i On the "**Tone**" tab, the **Ambience** audio settings and **Bass**, **Medium** and **Treble** are different and independent for each audio source.

On the "**Balance**" tab, the **All passengers**, **Driver** and **Front only** settings are common to all sources.

On the "**Sound**" tab, activate or deactivate "**Volume linked to speed**", "**Auxiliary input**" and "**Touch tones**".

! The sound distribution (or spatialisation with the Arkamys® system) is audio processing that allows the quality of the sound to be adapted according to the number of passengers in the vehicle.

i On-board audio: Arkamys® Sound Staging optimises the distribution of sound in the passenger compartment.

DAB radio (Digital Audio Broadcasting)

Terrestrial Digital Radio

! Digital radio provides higher quality reception.
The different multiplexes offer a choice of radio stations arranged in alphabetical order.



Press **Radio Media** to display the primary page.

5

Press the "**OPTIONS**" button to go to the secondary page.



Press "**Band**" to select "**DAB band**".



Press in the grey zone to confirm.

FM-DAB Follow-up

i "DAB" does not cover 100% of the territory.
When the digital radio signal is poor, the "FM-DAB Follow-up" allows you to continue listening to the same station, by automatically switching to the corresponding "FM" analogue station (if there is one).



Press **Radio Media** to display the primary page.

5

Press the "**OPTIONS**" button to go to the secondary page.



Activate / Deactivate "**FM-DAB Follow-up**".



Press in the grey zone to confirm.

i If the "FM-DAB Follow-up" is activated, there is a difference of a few seconds when the system switches to "FM" analogue radio with sometimes a variation in volume.
Once the digital signal is restored, the system automatically changes back to "DAB".

! If the "DAB" station being listened to is not available on "FM", or if the "FM-DAB Follow-up" is not activated, the sound will cut out while the digital signal is too weak.

Media

USB port

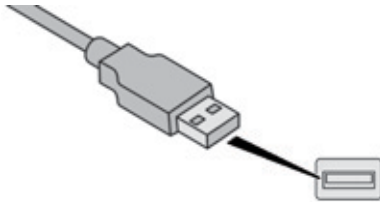

Insert the USB memory stick in the USB port or connect the USB device to the USB port using a suitable cable (not supplied).

! To protect the system, do not use a USB hub.

The system builds playlists (in temporary memory), an operation which can take from a few seconds to several minutes at the first connection.

Reduce the number of non-music files and the number of folders to reduce the waiting time.

The playlists are updated every time the ignition is switched off or connection of a USB memory stick. The lists are memorised: if they are not modified, the subsequent loading time will be shorter.

Auxiliary socket (AUX)

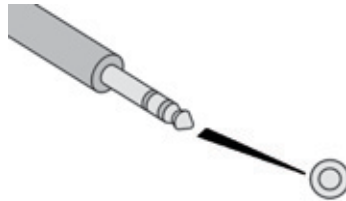

This source is only available if "Auxiliary input" has been checked in the audio settings.

Connect the portable device (MP3 player...) to the auxiliary Jack socket using an audio cable (not supplied).

First adjust the volume of your portable device (to a high level). Then adjust the volume of your audio system.

Display and management of the controls are via the portable device.

Selecting the source



Press **Radio Media** to display the primary page.



Press the **"SOURCES"** button.

Choose the source.

Bluetooth Streaming®

Streaming allows you to listen to music from your telephone.

The Bluetooth profile must be activated. First adjust the volume on your portable device (to a high level).

Then adjust the volume of your system.

If play does not start automatically, it may be necessary to start the audio playback from the smartphone.

Control is from the portable device or by using the system's touch buttons.

! Once connected in Streaming mode, the smartphone is considered to be a media source.

Connecting Apple® players

Connect the Apple® player to the USB port using a suitable cable (not supplied). Play starts automatically.

Control is via the audio system.

i The classifications available are those of the portable device connected (artists / albums / genres / playlists / audiobooks / podcasts), you can also use a classification structured in the form of a library.

The default classification used is by artist. To modify the classification used, return to the first level of the menu then select the desired classification (playlists for example) and confirm to go down through the menu to the desired track.

The version of software in the audio system may not be compatible with the generation of your Apple® player.

Information and advice

! The system supports USB Mass Storage devices, BlackBerry® devices or Apple® players via USB ports. The adaptor cable is not supplied. Control of the peripheral device is with the audio system controls. Other peripherals, not recognised on connection, must be connected to the auxiliary socket using a Jack cable (not supplied) or via Bluetooth streaming, depending on compatibility.

! To protect the system, do not use a USB hub.

The audio equipment will only play audio files with ".wav, .wma, .aac, .ogg and .mp3" file extensions and with a bit rate of between 32 Kbps and 320 Kbps. It also supports VBR (Variable Bit Rate) mode. No other type of file (.mp4, ...) can be played. ".wma" files must be of the standard wma 9 type. The sampling rates supported are 11, 22, 44 and 48 KHz.

It is advisable to restrict file names to 20 characters, without using of special characters (e.g.: " " ? ; ù) to avoid any playing and displaying problems.

Use only USB memory sticks formatted FAT 32 (file allocation table).









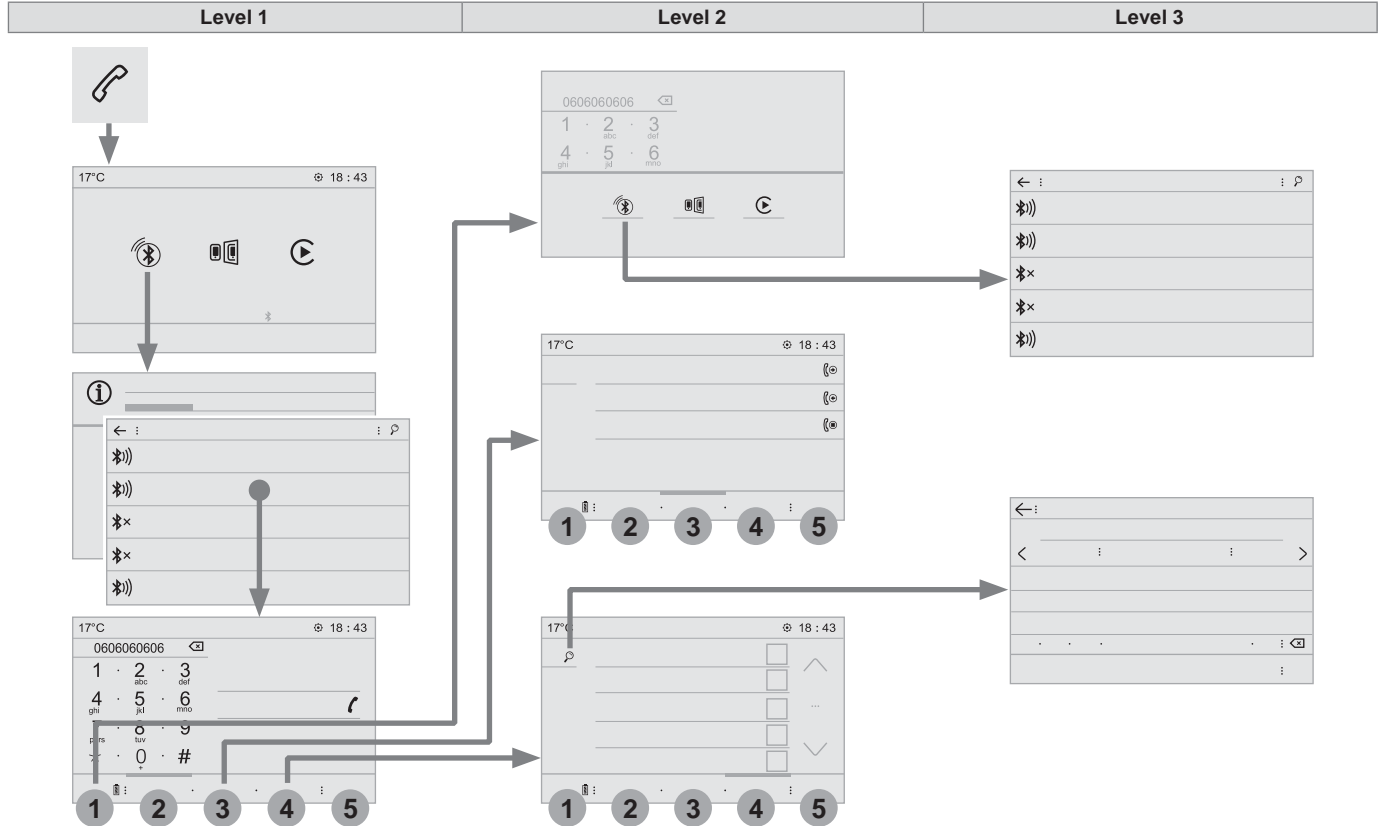











i It is recommended that the original USB cable for the portable device is used.

In order to be able to play a burned CDR or CDRW, select standards ISO 9660 level 1, 2 or Joliet if possible when burning the CD. If the disc is burned in another format, it may not be played correctly. It is recommended that the same burning standard is always used on an individual disc, with the lowest speed possible (4x maximum) for the best acoustic quality. In the particular case of a multi-session CD, the Joliet standard is recommended.

Telephone

According to version











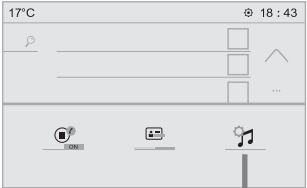

| Level 1 | | Level 2 | | Level 3 | | Comments |
|--|--|---|--|---|--|---|
|   1 | Telephone ↓ Bluetooth search ↓ PHONE |  Bluetooth connection |  Search | | Start the search for a device to be connected. | |
| | | | |  Delete | | Delete one or more devices. |
| | |  MirrorLink | | | | Open the MirrorLink function. |
| | |  CarPlay | | | | Open the CarPlay function. |
|   2 | Telephone ↓ Bluetooth search ↓ Keypad |  | | | Enter a telephone number. | |
|   3 | Telephone ↓ Bluetooth search ↓ Recent calls | All | | | View the calls according to the presentation selected. Select a contact to make the call. | |
| | |  Outgoing | | | | |
| | |  Missed | | | | |
| | |  Incoming | | | | |
|   4 | Telephone ↓ Bluetooth search ↓ Contacts |  Search |  Confirm | | Search for a contact in the contacts directory. | |
| | |  Telephone | | | | Go to the details of the contact sheet. |

Level 1 | Level 2



5



| Level 1 | | Level 2 | | Comments |
|--|--|---|------------------------|--|
|  5  | <p>Telephone</p> <p>↓</p> <p>OPTIONS</p> <p>↓</p> <p>On hold (auto)</p> |  | <p>ON - OFF</p> | <p>Activate or deactivate the automatic placing on hold of the current conversation.</p> |
|  5  | <p>Telephone</p> <p>↓</p> <p>OPTIONS</p> <p>↓</p> <p>Sort contacts by name</p> <p>Sort contacts by first name</p> |  | | <p>Sort the contacts by Surname-first name or First name-surname.</p> |
|  5  | <p>Telephone</p> <p>↓</p> <p>OPTIONS</p> <p>↓</p> <p>Ring volume</p> |  | | <p>Adjust the volume of the ringtone.</p> |

MirrorLink™ smartphone connection

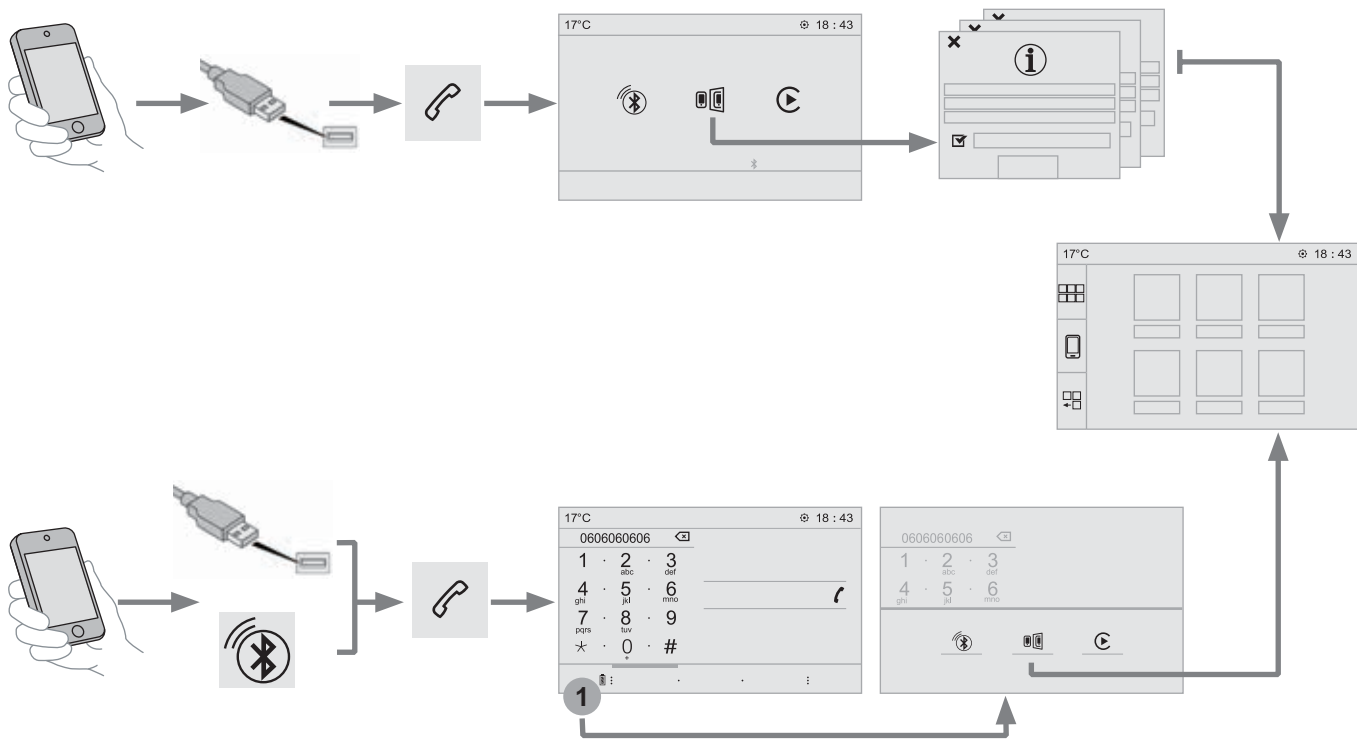

! As a safety measure and because it requires the sustained attention of the driver, using a smartphone when driving is prohibited. Operation must be with the **vehicle stationary**.

i The synchronisation of a smartphone allows applications on a smartphone that are adapted to the MirrorLink™ technology to be displayed in the vehicle's screen. The principles and standards are constantly evolving. For the communication process between the smartphone and the system to work correctly, the smartphone must be unlocked; **update the operating system of your smartphone as well as the date and time in the smartphone and the system**. For the list of eligible smartphones, connect to the Brand's internet website in your country.

! As a safety measure, applications can only be viewed with the vehicle stationary; display is interrupted once the vehicle is moving.

i The "MirrorLink™" function requires a compatible smartphone and applications.

Telephone not connected by Bluetooth®



Connect the USB cable. The smartphone charges when connected by a USB cable.



From the system, press "**Telephone**" to display the primary page.



Press "**MirrorLink™**" to start the application in the system.

Depending on the smartphone, it may be necessary to activate the "**MirrorLink™**" function.

OK

During the procedure, several screen pages relating to certain functions are displayed. Accept to start and end the connection.



When connecting a smartphone to the system, it is recommended that "Bluetooth®" be started on the smartphone

Telephone connected by Bluetooth®



From the system, press "**Telephone**" to display the primary page.



Press the "**PHONE**" button to display the secondary page.







Press "**MirrorLink™**" to start the application in the system.

Once connection is established, a page is displayed with the applications already downloaded to your smartphone and adapted to the MirrorLink™ technology.

Access to the different audio sources remains accessible in the margin of the MirrorLink™ display, using touch buttons in the upper bar. Access to the menus for the system is possible at any time using the dedicated buttons



There may be a wait for the availability of applications, depending on the quality of your network.

| Level 1 | | Level 2 | | Level 3 | Comments |
|--|--|---|--|---------|---|
|   | <p style="text-align: center;">Telephone ↓ MirrorLink™</p> |  | | | Go to or return to the applications already downloaded to your smartphone and adapted to the MirrorLink™ technology. |
| | |  | | | Go to a menu list depending on the application chosen. "Back": abandon the current operation, go up one level. "Home": go to or return to the "Car mode" page on your smartphone. |
| | |  | | | Go to the primary page of the "Telephone" menu. |

CarPlay® smartphone connection

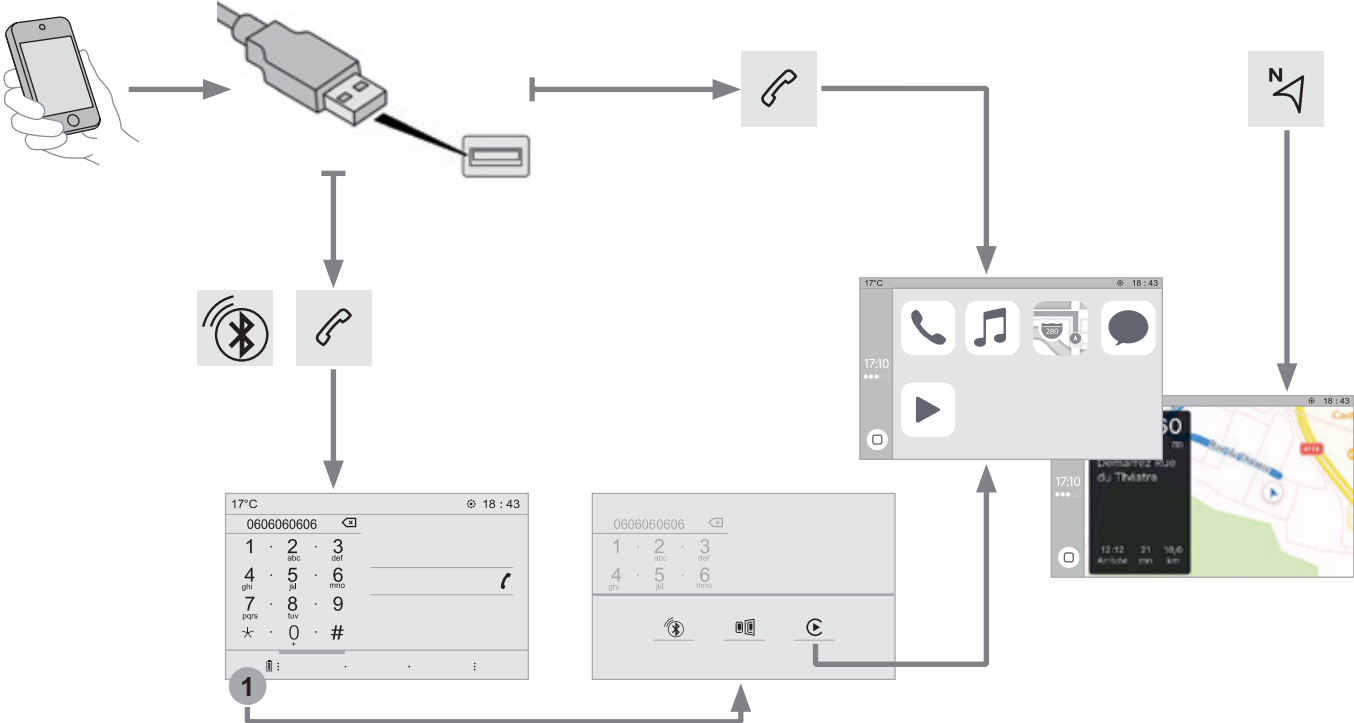

! As a safety measure and because it requires the sustained attention of the driver, using a smartphone when driving is prohibited. Operation must be with the **vehicle stationary**.

i The synchronisation of a smartphone allows applications on a smartphone that are adapted to the CarPlay® technology to be displayed in the vehicle's screen, having first activated the CarPlay® function in the smartphone. As the principles and standards are constantly changing, **it is recommended that you keep your smartphone's operating system updated**. For the list of eligible smartphones, go to the Brand's internet website in your country.



Connect the USB cable. The smartphone charges when connected by a USB cable.



From the system, press **Telephone** to display the CarPlay® interface.

Or



If the smartphone is already connected by Bluetooth®.



Connect the USB cable. The smartphone charges when connected by a USB cable.



From the system, press **Telephone** to display the primary page.



Press the "**PHONE**" button to go to the secondary page.



Press "**CarPlay**" to display the CarPlay® interface.

i On connecting the USB cable, the CarPlay® function deactivates the system's Bluetooth® mode.



You can go to the CarPlay® navigation at any time by pressing the system's **Navigation** button.

Pairing a Bluetooth® telephone

! As a safety measure and because it requires sustained attention by the driver, the pairing of a Bluetooth mobile telephone with the Bluetooth hands-free system of your audio system must be done with the **vehicle stationary** and the ignition on.

i Activate the Bluetooth function on the telephone and ensure that it is "visible to all" (telephone configuration).

Procedure from the telephone



Select the name of the system in the list of devices detected.

In the system, accept the connection request from the telephone.

! To complete the pairing, whichever procedure used (from the telephone or from the system), ensure that the code is the same in the system and in the telephone.

Procedure from the system



Press **Telephone** to display the primary page.



Press **"Bluetooth search"**. The list of telephones detected is displayed.



Select the name of the chosen telephone in the list.

i If the pairing procedure fails, it is recommended that you deactivate and then reactivate the Bluetooth function in your telephone.

i Depending on the type of telephone, you may be asked to accept or not the transfer of your contacts and messages.

Automatic reconnection

i On return to the vehicle, if the last telephone connected is present again, it is automatically recognised and within about 30 seconds of switching on the ignition, the connection is established without any action on your part (Bluetooth activated).

To modify the connection profile:



Press **Telephone** to display the primary page.



Press the "**PHONE**" button to go to the secondary page.



Press "**Bluetooth connection**" to display the list of paired devices.



Press the "details" button of a paired device.

The system offers to connect the telephone with 3 profiles:

- "**Telephone**" (hands-free kit, telephone only),
- "**Streaming**" (wireless playing of the audio files on the telephone),
- "**Internet data**".



Select one or more profiles.



Press "**OK**" to confirm.

! The ability of the system to connect with just one profile depends on the telephone. All three profiles may connect by default.

! The services available depend on the network, the SIM card and the compatibility of the Bluetooth devices used. Check in your telephone's manual and with your service provider for the services available to you.

i The profiles compatible with the system are HFP, OPP, PBAP, A2DP, AVRCP, MAP and PAN.

Go to the Brand's website for more information (compatibility, additional help, ...).

Managing paired telephones

i This function allows the connection or disconnection of a peripheral device as well as the deletion of a pairing.



Press **Telephone** to display the primary page.

1

Press the "**PHONE**" button to go to the secondary page.



Press "**Bluetooth connection**" to display the list of paired peripheral devices.



Press on the name of the telephone chosen in the list to disconnect it. Press again to connect it.

Deleting a telephone



Press the basket at the top right of the screen to display a basket alongside the telephone chosen.



Press the basket alongside the telephone chosen to delete it.

Receiving a call

An incoming call is announced by a ring and a superimposed display in the screen.



Make a short press on the steering mounted **PHONE** button to accept an incoming call.

And



Make a long press



on the steering mounted **PHONE** button to reject the call.

Or



Press "**End call**".

Making a call

! Using the telephone is not recommended while driving. Park the vehicle. Make the call using the steering mounted controls.

Calling a new number



Press **Telephone** to display the primary page.



Enter the phone number using the digital keypad.



Press "**Call**" to start the call.

Calling a contact



Press **Telephone** to display the primary page.



Or make a long press



on the steering mounted **PHONE** button.



Press "**Contacts**".

Select the desired contact from the list offered.



Press "**Call**".

Calling a recently used number



Press **Telephone** to display the primary page.

Or



Make a long press



on the steering mounted button.



Press "**Recent calls**".

Select the desired contact from the list offered.



It is always possible to make a call directly from the telephone; as a safety measure, first park the vehicle.

Setting the ringtone



Press **Telephone** to display the primary page.



Press the "**OPTIONS**" button to go to the secondary page.



Press "**Ring volume**" to display the volume bar.









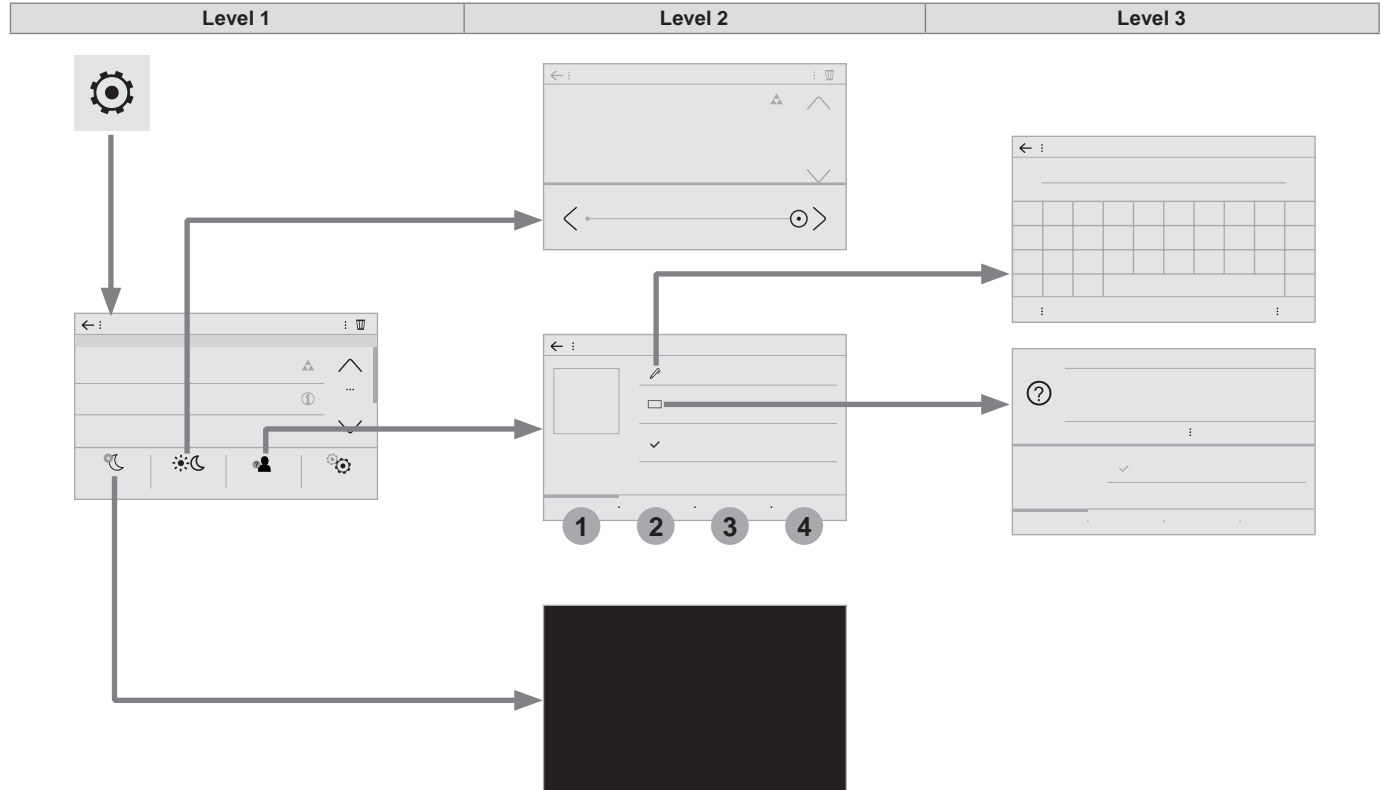











Press the arrows or move the cursor to set the ring volume.

Settings







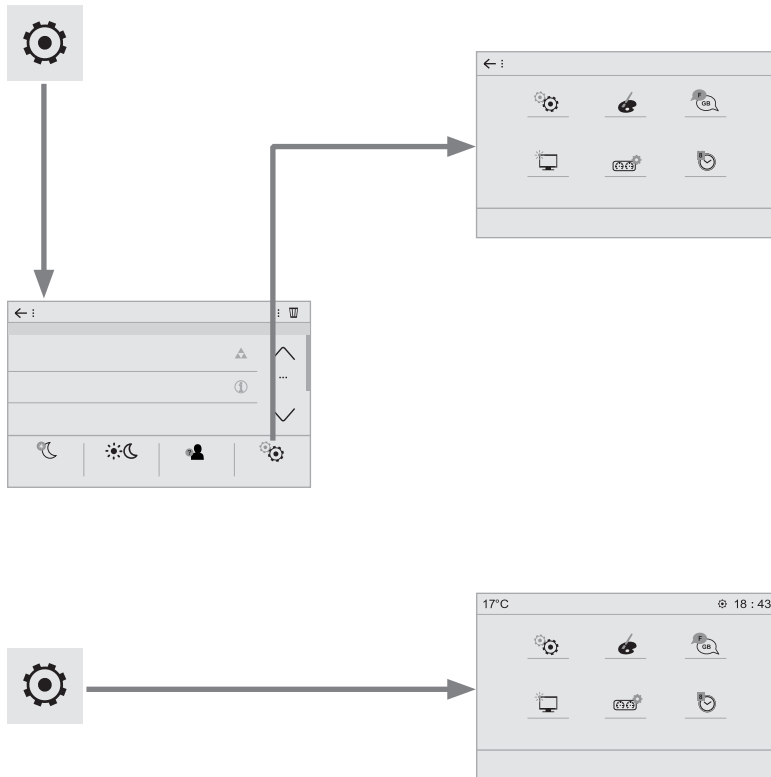

According to version / according to equipment











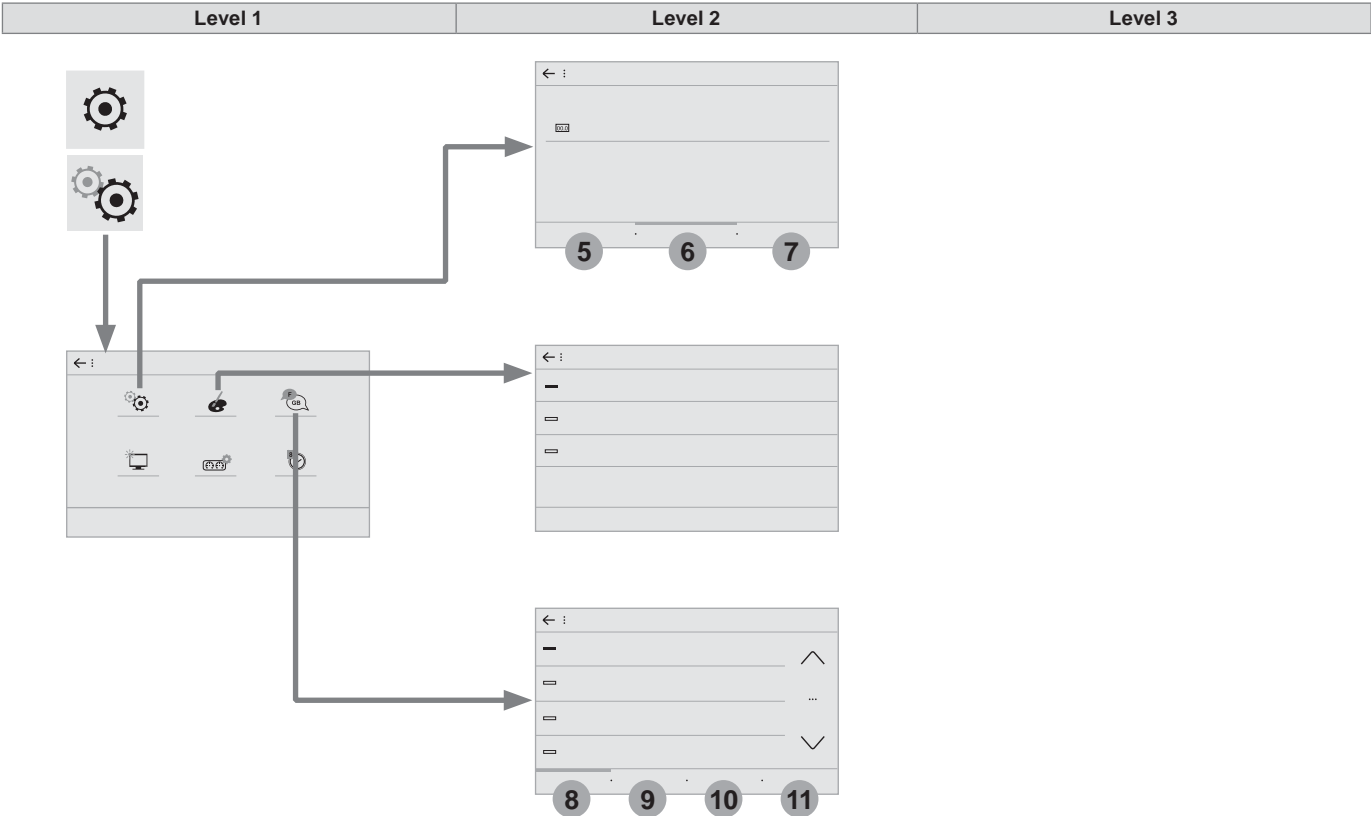





















| Level 1 | | Level 2 | | Level 3 | | Comments | | |
|--|---|---|---|--|----------------------------------|--|--|---|
|   | Settings ↓ Brightness |  | Ambience | | | Move the cursor to adjust the brightness of the screen and/or of the instrument panel. | | |
|   | Settings ↓ Profiles |  | Profile 1 | | | Select a profile. | | |
| | |  | Profile 2 | | | | | |
| | |  | Profile 3 | | | | | |
| | |  | Common profile | | | | | |
| | |  | Name: |   | Profile name modification | | | Configure the profiles. |
| | |  | Reset the profile |  | Yes / No | | | |
| | | |  | Profile activated | | | | Activate/deactivate the profile selected. |
| |  | | | | | Save the settings. | | |
|   | Settings ↓ Dark |  | | | | Function which switches off the lit display. Pressing the screen reactivates it. | | |

According to equipment









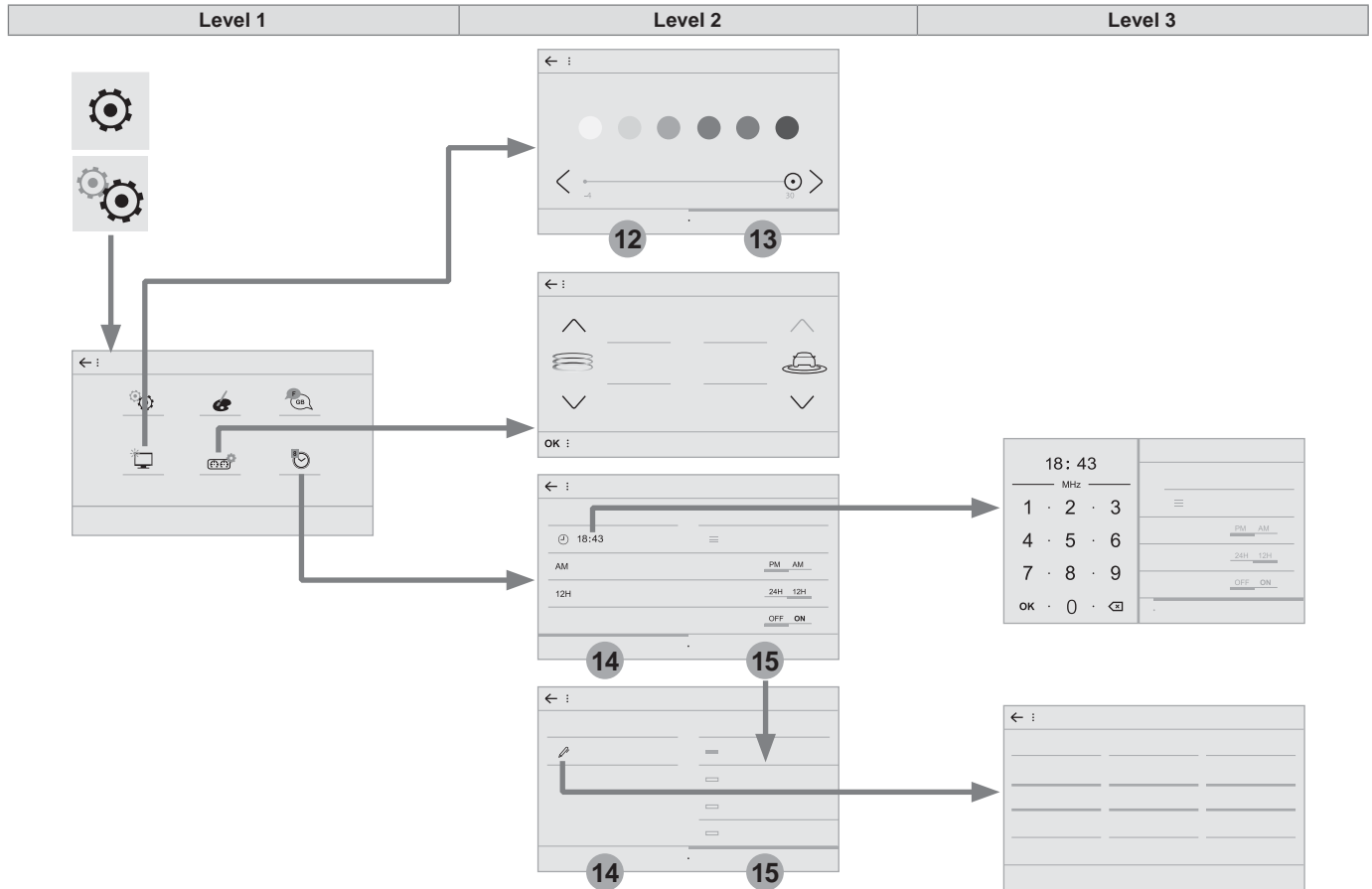









| Level 1 | | Level 2 | | Comments |
|--|--|---|-----------------------------|---|
|   | Settings ↓ Configuration |  | System configuration | Configure certain system parameters. |
| | |  | Ambience | Select an ambience for the screen integrated in the system. |
| | |  | Language | Select the display language for the the screen and/or the instrument panel. |
| | |  | Screen configuration | Set the configuration of the screen and/or the instrument panel. |
| | |  | Customization | Configure the instrument panel for a personalised display. |
| | |  | Date and time | Set the date and time and select the display format. |



| Level 1 | | Level 2 | | Level 3 | | Comments | | |
|---|---|---|---|---|---|---|-------|---|
|    | Settings ↓ Configuration ↓ System configuration |  | Units |  | Distance and fuel consumption | Configure the display units for the distance, consumption and temperature. | | |
| | | | |  | Temperatures | | | |
| | | | |  | Factory settings |  | Reset | Restore the original settings. |
| | | | |  | System info |  | View | Consult the version of the different modules installed in the system. |
| | |  | | | | Save the parameters. | | |
|    | Settings ↓ Configuration ↓ Ambience |  | | | | Select an ambience for the screen integrated in the system. | | |
| | |  | | | | | | |
| | |  | | | | | | |
| | | | |  | | | | Confirm the selection and start the change of ambience. |
|    | Settings ↓ Configuration ↓ Language |  | All |  | | Select the display language for the screen and/or the instrument panel. | | |
| | | |  | Europe |  | | | |
| | | |  | Asia |  | | | |
| | | |  | America |  | | | |
| | | | |  | | | | Save the parameter. |



| Level 1 | | Level 2 | | Level 3 | | Comments |
|---|---|---------|---------------|---|----------------------|---|
|    | Settings ↓ Configuration ↓ Screen configuration | 12 | Brightness | | | Select the display brightness level. |
| | | 13 | Animation | <input checked="" type="checkbox"/> | Automatic scrolling | Activate or deactivate the parameters. |
| | | | | <input checked="" type="checkbox"/> | Animated transitions | |
| | | | ← | | | |
|    | Settings ↓ Configuration ↓ Temperature conditioning | | Customization | | | Choose and select the display information required. |
| | | OK | Confirm | | | Confirm the selections. |
|    | Settings ↓ Configuration ↓ Date and time | 14 | Time |  | Time | Set the time. |
| | | | |  | Time Zone | Set the time zone. |
| | | | |  | AM | Select the display format. |
| | | | |  | 12h | |
| | | | |  | GPS Synchronisation | Activate or deactivate the synchronisation with the satellites. |
| | | | | ← | | Save the settings. |
| | | 15 | Date |  | Date | Set the date and select the display format. |
| | | | |  | Setting the date | |
| ← | | | | Save the settings. | | |

Profile settings

! As a safety measure and because it requires the sustained attention of the driver, changes to settings must only be done with the **vehicle stationary**.



Press **Settings** to display the primary page.



Press "**Profiles**".

1

Select "**Profile 1**" or "**Profile 2**" or "**Profile 3**" or "**Common profile**".



Press this button to enter a name for the profile using the virtual keypad

OK

Press "**OK**" to save.



Press the back arrow to confirm.



Press this button to activate the profile.



Press the back arrow again to confirm.



Press this button to initialise the profile selected.

Adjust the brightness



Press **Settings** to display the primary page.



Press **Brightness**.



Move the cursor to adjust the brightness of the screen and/or of the instrument panel (according to version).



Press in the grey zone to confirm.

Modifying system settings



Press **Settings** to display the primary page.



Press "**Configuration**" to go to the secondary page.



Press "**System configuration**".

5

Press "**Units**" to change the units for distance, fuel consumption and temperature.

6

Press "**Factory settings**" to return to the initial settings.



Returning the system to factory settings activates the English language by default (according to version).

7

Press "**System info**" to display the versions of the different modules installed in the system.



Press the back arrow to confirm.



Press **Settings** to display the primary page.



Press "**Configuration**" to go to the secondary page.



Press "**Screen configuration**".



Press "**Brightness**".



Move the cursor to set the brightness of the screen and/or instrument panel (according to version).



Press "**Animation**".



Activate or deactivate: "**Automatic scrolling**".



Select "**Animated transitions**".



Press the back arrow to confirm.

Select the language



Press **Settings** to display the primary page.



Press "**Configuration**" to go to the secondary page.













Select "**Language**" to change the language.



Press the back arrow to confirm.







Setting the time

-  Press **Settings** to display the primary page.
-  Press "**Configuration**" to go to the secondary page.
-  Press "**Date and time**".
-  Select "**Time**".
-  Press this button to adjust the time using the virtual keypad.
-  Press "**OK**" to save the time.
-  Press this button to define the time zone.
-  Select the display format for the time (12h / 24h).
-  Activate or deactivate synchronisation with satellites (UTC).

 Press the back arrow to save the settings.

 The system does not automatically manage the change between winter and summer time (depending on the country of sale).

Setting the date

-  Press **Settings** to display the primary page.
-  Press "**Configuration**" to go to the secondary page.
-  Press "**Date and time**".
-  Select "**Date**".
-  Press this button to define the date.
-  Press the back arrow to save the date.
-  Select the display format of the date.
-  Press the back arrow again to confirm.

 Adjustment of the time and date is only available if "GPS Synchronisation:" is deactivated. The change between winter and summer time is done by changing the time zone.

Frequently asked questions

The following table groups together the answers to the most frequently asked questions concerning your audio system.

Radio

| QUESTION | ANSWER | SOLUTION |
|---|--|---|
| The quality of reception of the radio station listened to gradually deteriorates or the stored stations do not function (no sound, 87.5 Mhz is displayed...). | The vehicle is too far from the transmitter used by the station listened to or there is no transmitter in the geographical area through which the vehicle is travelling. | Activate the "RDS" function by means of the upper band to enable the system to check whether there is a more powerful transmitter in the geographical area. |
| | The environment (hills, buildings, tunnels, basement car parks...) block reception, including in RDS mode. | This phenomenon is normal and does not indicate a fault with the audio system. |
| | The aerial is absent or has been damaged (for example when going through a car wash or into an underground car park). | Have the aerial checked by a franchised dealer. |
| I cannot find some radio stations in the list of stations received. | The station is not received or its name has changed in the list. | Press the round arrow on the "List" tab of the "Radio" page. |
| The name of the radio station changes. | Some radio stations send other information in place of their name (the title of the song for example). The system interprets this information as the name of the station. | |

Media

| QUESTION | ANSWER | SOLUTION |
|--|--|--|
| Playback of my USB memory stick starts only after a very long wait (around 2 to 3 minutes). | Some files supplied with the memory stick may greatly slow down access to reading the memory stick (multiplication by 10 of the catalogue time). | Delete the files supplied with the memory stick and limit the number of sub-folders in the file structure on the memory stick. |
| Some characters in the media information are not displayed correctly while playing. | The audio system does not display some types of characters. | Use standard characters to name tracks and folders. |
| Playing of streaming files does not start. | The peripheral device connected does not support automatic play. | Start the playback from the device. |
| The names of tracks and the track length are not displayed on the screen when streaming audio. | The Bluetooth profile does not allow the transfer of this information. | |

Telephone

| QUESTION | ANSWER | SOLUTION |
|---|---|--|
| I cannot connect my Bluetooth telephone. | The telephone's Bluetooth function may be switched off or the telephone may not be visible. | Check that your telephone's Bluetooth function is switched on. Check in the telephone settings that it is "visible to all". |
| | The Bluetooth telephone is not compatible with the system. | You can check the compatibility of your telephone at the Brand's website (services). |
| The volume of the telephone connected in Bluetooth mode is inaudible. | The volume depends both on the system and on the telephone. | Increase the volume of the audio system, to maximum if required, and increase the volume of the telephone if necessary. |
| | The ambient noise level has an influence on the quality of telephone communication. | Reduce the ambient noise level (close the windows, reduce the booster fan speed, slow down, ...). |
| Contacts are not shown in alphabetical order. | Some telephones offer display options. Depending on the settings chosen, contacts can be transferred in a specific order. | Modify the display setting in the telephone directory. |

Settings

| QUESTION | ANSWER | SOLUTION |
|---|--|--|
| In changing the setting of treble and bass the equalizer setting is deselected. | The selection of an equalizer setting imposes the settings for treble and bass and vice-versa. | Modify the treble and bass or equalizer settings to obtain the desired musical ambience. |
| In changing the equalizer setting, treble and bass return to zero. | | |
| When changing the balance settings, the distribution setting is deselected. | The selection of a distribution setting imposes the balance settings and vice-versa. | Modify the balance or distribution settings to obtain the desired musical ambience. |
| When changing a distribution setting, the balance setting is deselected. | | |
| There is a difference in sound quality between the different audio sources. | For optimum sound quality, the audio settings can be adapted to the different sound sources, which may result in audible differences when changing source. | Check that the audio settings are adapted to the sources listened to. Adjust the audio functions to the middle position. |
| With the engine off, the system switches off after a few minutes of use. | When the engine is switched off, the system's operating time depends on the state of charge of the battery. The switch-off is normal: the system switches to economy mode and switches off to prevent discharging of the vehicle's battery. | Start the vehicle's engine to increase the battery charge. |

Bluetooth® audio system

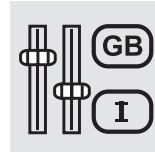
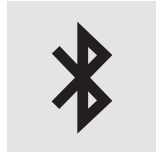
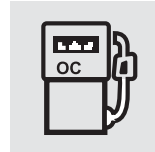

! As a safety measure and because it requires the sustained attention of the driver, the pairing of your Bluetooth telephone to the Bluetooth hands-free audio system must only be carried out with the **vehicle stationary** and the ignition on.

! Your audio system is coded in such a way that it will only operate in your vehicle.
All work on the system must be carried out exclusively by a dealer or qualified workshop, to avoid any risk of electrocution, fire or mechanical faults.

| | Contents |
|--|----------|
| First steps | 148 |
| Steering mounted controls - Type 1 | 149 |
| Steering mounted controls - Type 2 | 150 |
| Menus | 151 |
| Radio | 152 |
| DAB (Digital Audio Broadcasting) radio | 154 |
| Media | 156 |
| Telephone | 161 |
| Frequently asked questions | 166 |

i The different functions and adjustments described vary according to the version and configuration of your vehicle.

i To avoid discharging the battery, the audio system may switch off after a few minutes if the engine is not running.

First steps



Press: On / Off
 Rotate: adjust volume.



Short press: change audio source (Radio; USB; AUX (if a device is connected); CD; Streaming).
 Long press: display the **Telephone** menu (if a telephone is connected).



Adjust audio settings:
 Front/rear fader; left/right balance; bass/treble; loudness; audio ambience.
 Activation / Deactivation of automatic volume adjustment (linked to the speed of the vehicle).



Radio:
 Short press: display the list of radio stations.
 Long press: update the list.
Media:
 Short press: display the list of folders.
 Long press: display the sorting options.



Select the screen display mode, between:
 Date; Audio functions; Trip computer; Telephone.



Confirm or display contextual menu.



Buttons 1 to 6.
 Short press: select the preset radio station.
 Long press: preset a station.



Radio:
 Automatic step by step search up / down for radio stations.
Media:
 Select previous / next CD, USB, streaming track.
 Scroll in a list.



Radio:
 Manual step by step search up / down for radio stations.
 Select previous / next MP3 track.

Media:
 Select previous / next folder / genre / artist / playlist on the USB device.
 Scroll in a list.



Abandon the current operation.
 Go up one level (menu or folder).



Access to main menu.



Activate / Deactivate TA (traffic announcements)
 Long press: select type of announcement.



Select waveband: FM / DAB / AM.



Steering mounted controls - Type 1



Radio:

Select the previous / next preset radio station.

Select the previous / next item in a menu or a list.

Media:

Select of the previous / next track.

Select the previous / next item in a menu or a list.

LIST

Radio:

Short press: display the list of radio stations.

Long press: update the list.

Media:

Short press: display the list of folders.

Long press: display the sorting options.

SRC /

Other than telephone calls:

Short press: change audio source (Radio; USB; AUX (if a device is connected); CD; Streaming), confirm if the **"Telephone"** menu is open. Long press: open the **"Telephone"** menu.

In the event of a telephone call:

Short press: accept the call.

Long press: reject the call.

During a telephone call:

Short press: open the contextual telephone menu.

Long press: end the call.

OK

Confirm a selection.



Increase volume.



Decrease volume.



Mute / Restore sound by simultaneously pressing the increase and decrease volume buttons.



Steering mounted controls - Type 2

MENU

Access to the main menu.



Increase volume.



Mute / Restore sound.



Decrease volume.

SRC /

Other than telephone call:

Short press: change audio source (Radio; USB; AUX (if a device is connected); CD; Streaming), confirm if the **"Telephone"** menu is open.
Long press: open the **"Telephone"** menu.

In the event of a telephone call:

Short press: accept the call.
Long press: reject the call.

During a telephone call:

Short press: open the contextual telephone menu.
Long press: end the call.



Start voice recognition of your smartphone via the system.

LIST

Radio:

Short press: display the list of radio stations.
Long press: update the list.

Media:

Short press: display the list of folders.
Long press: display the sorting options.



Radio:

Select the previous / next preset radio station.

Select the previous / next item in a menu or a list.

Media:

Select the previous / next track.
Select the previous / next item in a menu or a list.

Press the thumbwheel: confirm.

Menus

Depending on version.



"Multimedia": Media settings, Radio settings.

MENU

Press the **"MENU"** button.



"Telephone": Call, Directory management, Telephone management, End call.



Move from one menu to another.



"Trip computer".

OK

Enter a menu.



"Maintenance": Diagnosis, Warning log, ...



"Connections": Manage connections, search for devices.



"Personalisation-configuration": Define the vehicle settings, Choice of language, Display configuration, Choice of units, Date and time adjustment.

Radio

Selecting a station

SRC / Press the **SOURCE** button repeatedly and select the radio.

BAND Press this button to select a waveband (FM / AM / DAB).

◀▶ Press one of the buttons to carry out an automatic search for radio stations.

▲▼ Press one of the buttons to carry out a manual search up / down for radio frequencies.

LIST Press this button to display the list of stations received locally. To update this list, press for more than two seconds. The sound is cut while updating.

RDS

i The external environment (hills, buildings, tunnels, basement car parks, ...) may block reception, including in RDS mode. This is a normal effect of the way in which radio waves are transmitted and does not indicate any failure of the audio system.

i If RDS is not available, the RDS symbol appears barred in the screen.

! RDS, if activated, enables you to continue listening to the same station by automatic retuning to alternative frequencies. However, in certain conditions, coverage of an RDS station may not be assured throughout the country as radio stations do not cover 100 % of the territory. This explains the loss of reception of a station that can occur during a journey.

Short procedure

In **"Radio"** mode, press the **OK** button to activate or deactivate RDS directly.

Long procedure

MENU Press the **"MENU"** button.

◀▶ Select **"Audio functions"**.

OK Press **OK**.

◀▶ Select the **"FM waveband preferences"** function.

OK Press **OK**.

◀▶ Select **"RDS"**.

OK Press **OK**, RDS is displayed in the screen.

Receiving TA messages

! The TA (Traffic Announcement) function gives priority to TA alert messages. To operate, this function needs good reception of a radio station transmitting this type of message. When a traffic report is transmitted, the current audio source (Radio, CD, ...) is interrupted automatically to play the TA message. Normal playback of the audio source resumes at the end of the transmission of the message.

! Take care when increasing the volume while listening to TA messages. The volume may prove too high on return to the original audio source.

TA Press the **TA** button to activate or deactivate traffic messages.

Receiving INFO messages

i The INFO function gives priority to TA traffic announcements. To be active, this function needs good reception of a radio station that transmits this type of message. When a message is transmitted, the current audio source (Radio, CD, USB, ...) is interrupted automatically to receive the INFO message. Normal play resumes at the end of the message transmission.

TA Make a long press on this button to display the list of categories.

▲▼ Select or deselect categories.

OK Activate or deactivate the reception of the corresponding messages.

Display RADIO TEXT

i Radio text is information transmitted by the radio station related to the current programme or song.

OK With the radio displayed on the screen, press **OK** to display the contextual menu.

▲▼ Select "**RadioText (TXT) display**" and confirm **OK** to save.

DAB (Digital Audio Broadcasting) radio

According to version

i If the current "DAB" radio station is not available on "FM", "DAB FM" is struck out.

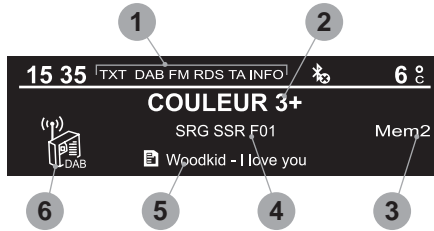

1 Display options: if active but not available, the display will be struck out.

2 Display the name of the current radio station.

3 Preset radio station, buttons 1 to 6. Short press: select the preset radio station. Long press: preset a radio station.

4 Display the name of the multiplex service being used.

5 Display RadioText (TXT) for the current radio station.

6 Represents the signal strength for the band being listened to.

i When changing region, an update of the list of preset radio stations is advisable.



LIST Display the list of all radio stations and "multiplexes".

Terrestrial digital radio

i Digital radio provides a superior audio quality and also additional categories of traffic announcements (TA INFO). The different "multiplex services" offer a choice of radio stations in alphabetical order.

BAND Change of band (FM1, FM2, DAB,...)

BAND

Change of station within the same "multiplex service".



Starting of a search for the previous / next "multiplex service".



TA Long press: select the desired categories of announcements from Transport, News, Entertainment and Flash special (availability according to the station).

DAB / FM tracking

i When the radio station is displayed in the screen, press on "**OK**" to display the contextual menu.
(Frequency search (RDS), DAB / FM auto tracking, RadioText (TXT) display, Information on the station, ...)

i "DAB" does not have 100% coverage of the country.
When the digital signal is weak, "DAB / FM auto tracking" allows you to continue listening to the same station, by automatically switching to the corresponding analogue "FM" station (if there is one).
When "DAB / FM auto tracking" is active, the DAB station will be selected automatically.

i If "DAB / FM auto tracking" is activated, there will be a difference of a few seconds in the programme when the system changes to analogue "FM" radio, with sometimes a variation in volume.

! If the "DAB" station you are listening to is not available on "FM" ("**DAB/FM**" option barred), or if "DAB / FM auto tracking" is not on, the sound will be cut when the digital signal is too weak.

MENU

Press the "**MENU**" button.



Select "**Multimedia**" and confirm.



Select "**DAB / FM auto tracking**" and confirm

Media

USB port

This unit consists of a USB port and an auxiliary Jack socket, depending on version.

! To protect the system, do not use a USB hub.

i Any additional equipment connected to the system must conform to the standard of the product or standard IEC 60950-1.

The system creates playlists (temporary memory), which can take from a few seconds to several minutes on the first connection. Reducing the number of non-music files and the number of folders reduces this waiting time. Playlists are updated every time a new USB memory stick is connected.

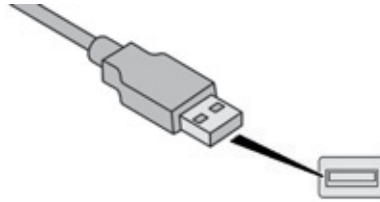

Insert a USB memory stick into the USB port or connect a USB peripheral device to the USB port using a suitable cable (not supplied). The system changes automatically to "USB" source.

i While connected by USB, the portable device may be charged automatically.

Play mode

The play modes available are:

- **Normal:** the tracks are played in order, depending on the classification of the selected files.
- **Random:** the tracks in an album or folder are played in a random order.
- **Random on all media:** all of the tracks saved in the media are played in random order.
- **Repeat:** the tracks played are only those from the current album or folder.

OK

Press this button to display the contextual menu for the Media function.



Press this button to select the play mode.

OK

Press this button to confirm.

The choice made is displayed at the top of the screen.

Choosing a track to play



Press one of these buttons to go to the previous / next track.



Press one of these buttons to go to the previous / next folder.

File classification



Make a long press on this button to display the different classifications.



Choose by "**Folder**" / "**Artist**" / "**Genre**" / "**Playlist**".*



Press **OK** to select the desired classification, then press **OK** again to confirm.

Playing files



Make a long press on this button to display the chosen classification.



Navigate in the list using the left / right and up / down buttons.



Confirm the selection by pressing **OK**.



Press one of these buttons to go to the previous / next track in the list. Press and hold one of these buttons for fast forward or fast back.



Press one of these buttons to go to the next "**Folder**" / "**Artist**" / "**Genre**" / "**Playlist**".* in the list.

* Depending on availability and the type of device used.

Jack auxiliary (AUX) socket



Connect the portable device (MP3 player, ...) to the auxiliary Jack socket using an audio cable (not supplied).

i Any additional equipment connected to the system must conform to the standard of the product or standard IEC 60950-1.

SRC / Press the **SOURCE** button several times in succession and select "AUX".

First adjust the volume on your portable device (to a high level). Then adjust the volume on your audio system. Operation of controls is via the portable device.

! Do not connect a device to both the Jack auxiliary socket and the USB port at the same time.

CD player

Insert circular compact discs only. Some anti-pirating systems, on original discs or CDs copied using a personal recorder, may cause faults which are no reflection on the quality of the vehicle's player. Insert a CD in the player, play begins automatically.

! External CD players connected via the USB port are not recognised by the system.

SRC / To play a disc which has already been inserted, press the **SOURCE** button several times in succession and select **CD**.

◀▶ Press one of the buttons to select a track on the CD.

LIST Press the **LIST** button to display the list of tracks on the CD.

◀▶ Press and hold one of the buttons for fast forward or fast back.

Playing an MP3 compilation

Insert an MP3 CD compilation in the player. The audio equipment searches for all of the music tracks, which may take anything between a few seconds and several tens of seconds, before play begins.

! On a single disc, the CD player can read up to 255 MP3 files spread over 8 folder levels. However, it is advisable to keep to a limit of two levels to reduce the access time before the CD is played. While the CD is being played, the folder structure is not followed. All of the files are displayed on a single level.

SRC /

To play a disc which has already been inserted, press the **SOURCE** button several times in succession and select **CD**.



Press one of the buttons to select a folder on the CD.



Press one of the buttons to select a track on the CD.

LIST

Press the **LIST** button to display the list of directories of the MP3 compilation.



Press and hold one of the buttons for fast forward or backward play.

Bluetooth® audio streaming

Streaming allows music files on the telephone to be played via the audio system.

Connect the telephone.
(Refer to the "**Pairing a telephone**" section).

SRC /

Activate the streaming source by pressing the **SOURCE*** button.

Audio files can be selected using the buttons on the audio system control panel and the steering mounted controls**. Contextual information may be displayed in the screen.

* In certain cases, play of the audio files must be initiated from the keypad.

** If the telephone supports the function. The audio quality depends on the quality of transmission by the telephone.

Connecting Apple® players

Connect the Apple® player to the USB port using a suitable cable (not supplied). Play starts automatically.

Control is via the audio system.

The classifications available are those of the portable device connected (artists / albums / genres / playlists).

The version of software in the audio system may not be compatible with the generation of your Apple® player.

Information and advice

The CD player can play files with .mp3, .wma, .wav and .aac file extensions, with a bit rate of 32 to 320 Kbps.

It also supports TAG mode (ID3 tag, WMA TAG).

Other file types (mp4, ...) may be played.

Files of the ".wma" type should be to the wma9 standard.

The sampling rates supported are 11, 22, 44 and 48 KHz.

Via the USB port, the system can play audio files with the extension ".mp3, .wma, .wav, .cbr, .vbr" with a bit rate of 32 to 320 Kbps.

No other file types (.mp4, ...) can be played.

Files of the ".wma" type should be to the wma9 standard.

The sampling rates supported are 11, 22, 44 and 48 KHz.

File names should have less than 20 characters, avoiding special characters (e.g.: " ? ; ù) so as to avoid any reading or display problems.

In order to be able to play a recorded CDR or CDRW, the ISO 9660 level 1. 2 or Joliet file format is recommended when recording.

If the disc is recorded in another format, it may not be played correctly.

It is recommended that the same recording format is always used for an individual disc, with as low a speed as possible (4x maximum) for optimum sound quality.

In the particular case of a multi-session CD, the Joliet format is recommended.

To protect the system, do not use a USB hub.



Use only USB memory sticks formatted FAT32 (File Allocation Table).



It is recommended that you use genuine Apple® USB cables for correct operation.

Telephone

Pairing a Bluetooth® telephone

! As a safety measure and because it requires the sustained attention of the driver, the pairing of your a Bluetooth telephone to the Bluetooth hands-free audio system must only be carried out with the vehicle stationary and the ignition on

i Activate the telephone's Bluetooth function and ensure that it is "visible to all" (telephone configuration).

i The services available depend on the network, the SIM card and the compatibility of the Bluetooth telephone used.
Refer to the instructions for your telephone and to your service provider for the services available to you.

Procedure from the telephone



Select the name of the system in the list of devices detected.

Procedure from the system

MENU

Press the **MENU** button.



Select the "**Connections**" menu.

OK

Confirm with **OK**.



Select "**Search for a Bluetooth device**".

OK

Confirm with **OK**.

A window is displayed with a search in progress message.

In the list of devices detected, select a telephone to pair. Only one telephone can be paired at a time.

Completing the pairing

! To complete the pairing, whichever procedure is used (from the telephone or from the system), check that the code displayed in the system and the telephone is the same and confirm.

If pairing fails, the number of attempts is not restricted.

A message appears in the screen confirming the pairing.

Information and advice

The "**Telephone**" menu gives access to the following functions in particular: "**Directory**", "**Calls list**", "**View paired devices**". Depending on the type of telephone, you may be asked to accept or confirm access by the system to each of these functions.

i Go to the Brand's website for more information (compatibility, more help, ...).

* If your telephone is fully compatible.

Managing connections

i The telephone connection automatically includes hands-free operation and audio streaming. The ability of the system to connect to just one profile depends on the telephone. Both profiles may connect by default.

MENU

Press the **MENU** button.



Select "**Connections**".

OK

Confirm with **OK**.



Select "**Connections management**" and confirm. The list of paired devices is displayed.

OK

Confirm with **OK**.



Indicates that a device is connected.



A number indicates the profile of the connection with the system:

- 1 for media or 1 for telephone.
- 2 for media and telephone.



Indicates the audio streaming profile.



Indicates the hands-free telephone profile.



Select a telephone.

OK

Confirm with **OK**.



Then select and confirm:

- "**Connect telephone**" / "**Disconnect telephone**": to connect / disconnect the telephone or the hands-free kit only.
- "**Connect media player**" / "**Disconnect media player**": to connect / disconnect streaming only.
- "**Connect telephone + media player**" / "**Disconnect telephone + media player**": to connect / disconnect the telephone (hands-free kit and streaming).
- "**Delete connection**": to delete the pairing.



When you delete a pairing in the system, remember to delete it from your telephone as well.

OK

Confirm with **OK**.

Receiving a call

An incoming call is announced by a ring and a superimposed display in the screen.



Select the **"YES"** tab in the screen using the buttons.

OK

Confirm with **OK**.

SRC /

Press this button at the steering mounted controls to accept the call.

Making a call

In the **"Telephone"** menu.

Select **"Call"**.

Select **"Dial"**.

Or

Select **"Directory"**.

Or

Select **"Calls list"**.

OK

Confirm with **OK**.

SRC /

Press this button for more than two seconds for access to your directory, then navigate using the thumb wheel.

Ending a call

In the **"Telephone"** menu.

Select **"End call"**.

Confirm with **OK** to end the call.

SRC /

During a call, press one of the buttons for more than 2 seconds.



The system accesses the telephone's contacts directory, depending on its compatibility, and while it is connected by Bluetooth



With certain telephones connected by Bluetooth, you can send a contact to the directory of the audio system. Contacts imported in this way are saved in a permanent directory visible to all, whatever the telephone connected.

The menu for the directory is not accessible if it is empty.

Managing calls

OK

During a call, press **OK** to display the contextual menu.

Hang up



In the contextual menu, select "**End call**" to end the call.

OK

Confirm with **OK**.

Microphone off

(so that the caller cannot hear)



In the contextual menu:

- select "**Micro OFF**" to switch off the microphone.
- deselect "**Micro OFF**" to switch the microphone on.

OK

Confirm with **OK**.

Telephone mode



In the contextual menu:

- select "**Telephone mode**" to transfer the call to the telephone (for example, to leave the vehicle while continuing a conversation).
- deselect "**Telephone mode**" to transfer the call to the vehicle.

OK

Confirm with **OK**.

If the contact has been cut off, when you reconnect on returning to the vehicle, the Bluetooth connection will be restored automatically and sound returned to the system (depending on the compatibility of the telephone).

In some cases telephone mode must be activated from the telephone.

Interactive voice response



From the contextual menu, select "**DTMF tones**" and confirm to use the digital keypad to navigate in the interactive voice response menu.

OK

Confirm with **OK**.

Dual call



From the contextual menu, select "**Switch**" and confirm to return to a call left on hold.

OK

Confirm with **OK**.

Directory



The system accesses the telephone's contacts directory, depending on its compatibility, and while it is connected by Bluetooth.



With certain telephones connected by Bluetooth you can send a contact to the directory of the audio system. Contacts imported in this way are saved in a permanent directory visible to all, whatever the telephone connected. The menu for the directory is not accessible if it is empty.



Make a long press on **SRC/TEL**.



Select "**Directory**" to see the list of contacts.

OK

Confirm with **OK**.

MENU

To modify the contacts saved in the system, press **MENU** then select "**Telephone**" and confirm. Select "**Directory management**" and confirm.

You can:

- "**Consult an entry**",
- "**Delete an entry**",
- "**Delete all entries**".

Voice recognition

This function allows you to use your smartphone's voice recognition via the system.

To start voice recognition, depending on the type of steering mounted controls:

Make a long press on the end of the lighting control stalk.

OR



Press this button.



Voice recognition requires the use of a compatible smartphone first connected to the vehicle by Bluetooth.

Frequently asked questions

The table below gives answers to the most frequently asked questions on your audio system.

| QUESTION | ANSWER | SOLUTION |
|--|---|--|
| With the engine off, the audio system switches off after a few minutes of use. | When the engine is switched off, the audio system operating time depends on the state of charge of the battery. The switch-off is normal: the audio equipment switches to economy mode and switches off to prevent discharging of the vehicle's battery. | Start the vehicle's engine to increase the battery charge. |
| The message "the audio system is overheated" appears on the display. | In order to protect the installation if the surrounding temperature is too high, the audio system switches to an automatic thermal protection mode leading to a reduction in volume or CD play stopping. | Switch the audio system off for a few minutes to allow the system to cool. |

Radio

| QUESTION | ANSWER | SOLUTION |
|--|---|--|
| There is a difference in sound quality between the different audio sources (radio, CD...). | For optimum sound quality, the audio settings (Volume, Bass, Treble, Ambience and Loudness) can be adapted to the different sound sources, which may result in audible differences when changing source (radio, CD...). | Check that the audio settings (Volume, Bass, Treble, Ambience and Loudness) are adapted to the sources listened to. It is advisable to set the audio functions (Bass, Treble, Front-Rear Balance and Left-Right Balance) to the middle position, select the musical ambience "None" and set the loudness correction to the "Active" position in CD mode or to the "Inactive" position in radio mode. |

| QUESTION | ANSWER | SOLUTION |
|---|--|--|
| The preset stations do not function (no sound, 87.5 Mhz is displayed...). | An incorrect waveband is selected. | Press the BAND button to return to the waveband (FM, FM2, DAB, AM) on which the stations are preset. |
| The traffic announcement (TA) is displayed. I do not receive any traffic information. | The radio station is not part of the regional traffic information network. | Tune to a radio station which broadcasts traffic information. |
| The quality of reception of the radio station listened to gradually deteriorates or the stored stations do not function (no sound, 87.5 Mhz is displayed...). | The vehicle is too far from the transmitter used by the station listened to or there is no transmitter in the geographical area through which the vehicle is travelling. | Activate the RDS function to enable the system to check whether there is a more powerful transmitter in the geographical area. |
| | The environment (hills, buildings, tunnels, underground car parks...) block reception, including in RDS mode. | This phenomenon is normal and does not indicate a fault in the audio system. |
| | The aerial is absent or has been damaged (for example when going through an automatic car wash or into an underground car park). | Have the aerial checked by a franchised dealer. |
| Sound cut-outs of 1 to 2 seconds in radio mode. | During this brief sound cut-out, the RDS searches for another frequency giving better reception of the station. | Deactivate the RDS function if the phenomenon is too frequent and always on the same route. |

Media

| QUESTION | ANSWER | SOLUTION |
|--|---|--|
| The Bluetooth connection is broken. | The state of charge of the device may be too low. | Charge the battery of the portable device. |
| The message "USB device error" is displayed in the screen. | The USB memory stick is not recognised. The USB memory stick may be corrupt. | Reformat the USB memory stick. |
| The CD is ejected every time or is not played. | The CD is upside down, cannot be read, does not contain audio files or contains audio files of a format not recognised by the audio system. The CD is protected by an anti-pirating system not recognised by the audio system. | <ul style="list-style-type: none"> - Check that the CD is inserted in the player the right way up. - Check the condition of the CD: the CD cannot be played if it is too damaged. - Check the content in the case of a recorded CD: consult the advice in the "Audio" section. - Due to their quality level, certain writeable CDs will not be played by the audio system. |
| The sound from the CD is poor. | The CD used is scratched or of poor quality. | Insert a good quality CD and store them in suitable conditions. |
| | The audio settings (base, treble, ambience) are unsuitable. | Return bass and treble settings to 0, without selecting an ambience. |
| I am unable to play the music files on my smartphone via the USB port. | Depending on the smartphone, access by the audio system to music on the smartphone may have to be approved on the latter. | Manual activate the MTP profile on the smartphone (USB settings menu). |

Telephone

| QUESTION | ANSWER | SOLUTION |
|--|---|--|
| I am unable to access my voicemail. | Few telephones or service providers allow the use of this function. | Call your voicemail box, via the telephone menu, using the number supplied by your service provider. |
| I am unable to access my directory of contacts. | Check the compatibility of your telephone. | |
| | You did not give access to your contacts when pairing the telephone. | Accept or confirm access by the system to the contacts on your telephone. |
| I am unable to continue a conversation when getting into my vehicle. | Telephone mode is activated. | Deselect telephone mode to transfer the call to the vehicle. |
| I am unable to pair my telephone by Bluetooth. | Telephones (models, versions of operating systems) have their own specific aspects in the pairing procedure and some telephones are not compatible. | Before starting the pairing procedure, delete the pairing of the telephone from the system AND of the system from the telephone, so as to see the compatibility of the telephones. |