



Combine harvesters

TUCANO

450 440 430 420 340 320

CLAAS



Time to grow. The new TUCANO.

Healthy growth is the basis of every successful harvest. It was with this principle in mind that we developed the new TUCANO. As well as growing to incorporate the intelligence and comfort of the large combine segment, it has a design which immediately announces a new dimension of excellence and gives you the capacity you need for the future:
Time to grow.

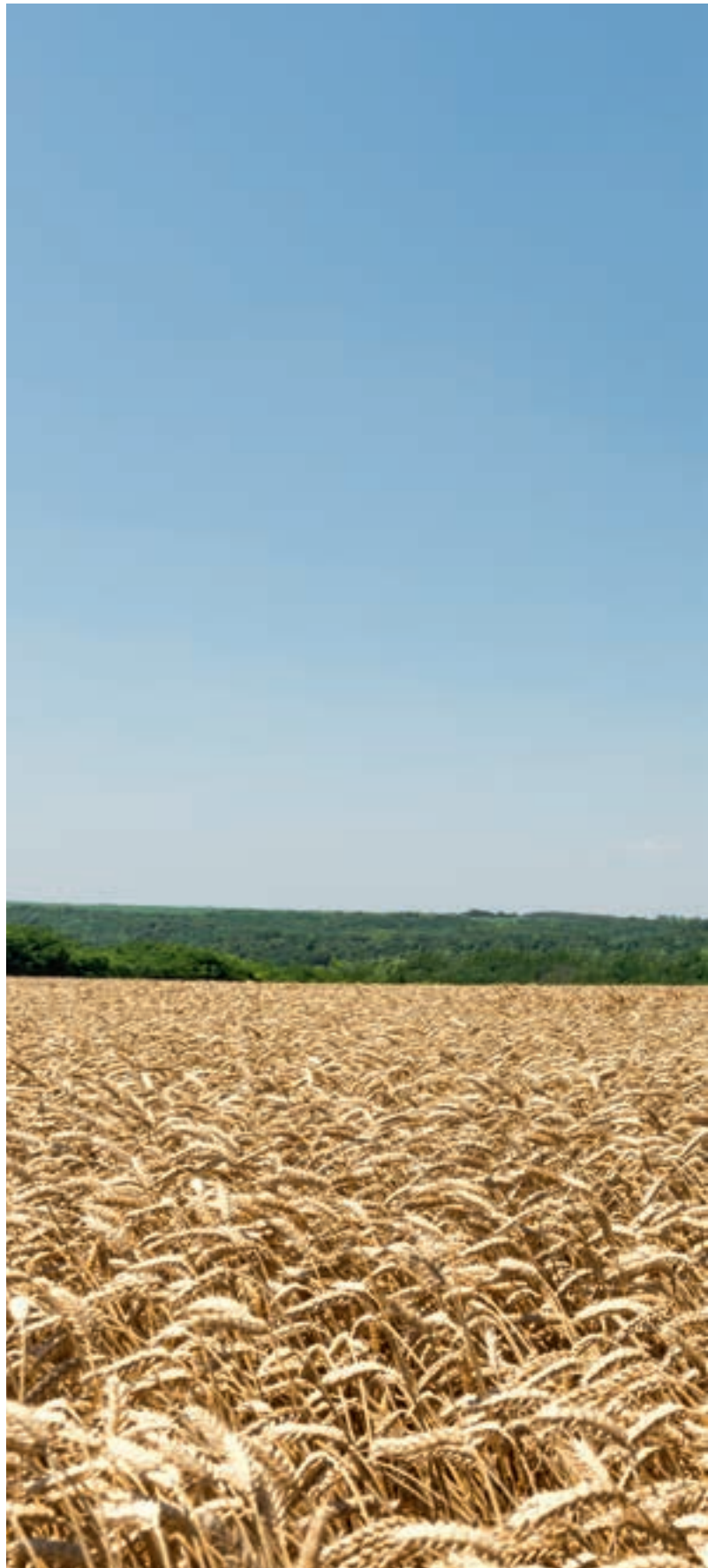

tucano400-300.claas.com



TUCANO 450 / 440 / 430 / 420 / 340 / 320.





Cab	6
EASY	11
CEBIS	12
CEBIS, multifunction control lever,	
CMOTION	14
TELEMATICS	16
Yield mapping, job management	18
Automatic guidance systems	20
Front attachments	22
Cutterbar	25
VARIO cutterbar, rapeseed cutterbar	26
VARIO 930 / 770, CERIO cutterbars	28
CONSPEED, CONSPEED LINEAR	30
SUNSPEED, SWATH UP	32
Rice cutterbar, FLEX	34
Automated cutterbar control	36
Threshing system	38
APS threshing system	40
CLAAS threshing system	42
Straw walker technology	44
Crop cleaning	46
Grain tank, QUANTIMETER,	
PROFI CAM	48
Straw management	50
CLAAS POWER SYSTEMS	52
Engine, drive train	54
All-wheel drive,	
central lubrication system	56
Tyres, maintenance	58
First CLAAS Service	60
Technology in detail	62
Benefits	66
Technical data	67

Well-being at work.
Deluxe comfort in your working environment.

At CLAAS, comfort and convenience mean that everything is designed to enable you to work with optimal efficiency. From the flawless 360° view to the smallest action.





More space. More comfort.
A more productive workplace.



For optimal working conditions.

The TUCANO gives the operator freedom of movement, a clear control layout and excellent visibility on all sides. The air conditioning maintains a consistent, comfortable atmosphere, which together with superb soundproofing and a three-position adjustable steering column provides first-class working conditions.



The steering column is adjustable three ways.



Cushions, supports, ventilates and keeps you warm: the deluxe operator's seat.

Full support for dynamic, active work while seated. Active comfort control ensures optimal ventilation and sweat removal without subjecting the operator to unhealthy draughts. The air suspension seat with automatic height control adjusts automatically to the operator's weight and effectively attenuates vibrations by up to 40%. A pneumatic, two-part lumbar support keeps your back in shape while the automatic thermostat for the seat's heating keeps you warm and comfortable.

Fully featured: trainee's seat with integrated cooler.

- Integrated armrest at left on door
- Foldable backrest as a table
- Large in-cab refrigerator, with capacity of 43 litres and a bottle holder
- Many other stowage compartments



Refrigerator box integrated in trainee's seat

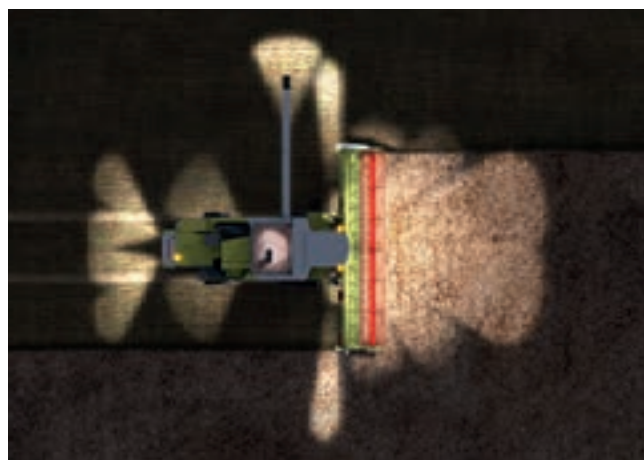

Turns night into day at the flick of a switch.

The lighting systems ensure the best visibility for the entire work area and machine parts even at night. Intelligent features, such as the afterlight function, make for a complete package. Powerful H9 and xenon lights turn night into day.

- Up to ten work lights
- Lighting for folding front attachments
- Side lights, stubble lights, steering axle lights
- Automatic lighting of the discharge auger tube
- Automatic reversing lights
- Lighting for the cleaning system, grain tank and returns
- Service lights below the side panels
- Mobile work light



The operating panel gives a good overview and enables simple control of the working lights. The light settings can be adjusted easily in CEBIS.

EASY. Simply more.





The name says it all.

All the electronics expertise of CLAAS can be summarised in a word: EASY.

That stands for Efficient Agriculture Systems, and it lives up to the name. Equipment settings, guidance systems, software solutions and more: EASY makes it all simple. Your systems can be matched perfectly with each other, enabling you to get the best performance from your combines and top results for your operation.

Go on. Go easy.

The EASY concept is made up of four components, each providing specialist competence and together forming a strong team.

- on board – Control and performance optimisation of the combine from the cab
- on field – Increased productivity directly in the field
- on track – Equipment monitoring and remote diagnostics
- on farm – Software solutions for your operation

More informed, more monitoring.



All's clear on the operating panel!

Integrated with the operator's seat, its flexible functions can be adapted as needed. Function switches include:

- A Menu selection rotary/push switch
- B CEBIS direct menu rotary switch
- C Escape button
- D HOTKEY rotary/push switch
- E HOTKEY direct menu rotary switch
- F Information button

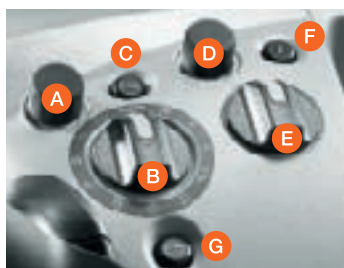

CEBIS controls and HOTKEY

- G DIRECT ACCESS button
- H CEBIS screen
- I Front attachment on/off
- J Threshing unit on/off
- K Front attachment reverser
- L Rapeseed knife, left, on/off
- M Lateral adjustment of cutterbar / changes to values in HOTKEY menu / longitudinal position of VARIO cutterbar table
- N LASER PILOT left/right preselection
- O All-wheel drive
- P Diesel engine speed (three steps)
- Q Grain tank cover open

 For more information, please visit: tucano400-300.claas.com



Keeping the operator in the picture at all times.

Information, registration, control and monitoring are the tasks of the CEBIS electronic on-board information system. It is distinguished by its clear, logical organisation of functions in the menu structure.

A brief glance at the CEBIS display gives an overview of the current processes and conditions: all the relevant information for driving or harvesting is summarised clearly on the screen. Warning messages are given audibly as a buzz tone and visually as icons and text.

An eye-catching 21 cm screen.

The 8.4" colour CEBIS screen offers an ideal view thanks to its ball coupling mount which enables the monitor to be adjusted as required by the operator. It can be adjusted for angle as well as horizontally and vertically.

Clear, simple and fast operation.

- The basic machine settings in working mode are made via the CEBIS rotary switch (B)
- An additional HOTKEY rotary switch allows fast access to other functions (E)
- The position of the rotary switch is shown on the CEBIS display (H)
- The CEBIS and HOTKEY rotary/push switches (A / D) are used for menu navigation and making changes to settings
- A Compact Flash Card makes data exchange particularly easy
- The DIRECT ACCESS button provides direct access to the last menu setting. It also offers fast access to the image from the camera

CEBIS on the road.

- 1 Menu bar
- 2 Travel speed and rpm
- 3 Operating hours
- 4 Fuel level and temperature display as well as AdBlue level

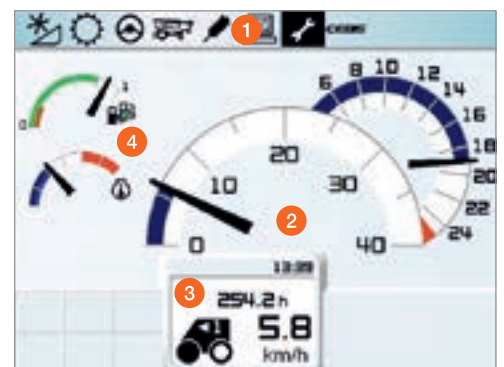

CEBIS in the field.

- 5 Throughput monitoring
- 6 Area scaling and yield metering
- 7 Driving information (up to 40 displays freely selectable)
- 8 Message window (for alarms and information)
- 9 Front attachment position (AUTO CONTOUR/ cutting height)



More functions at your fingertips.



CMOTION. Greater comfort.

The multifunction control lever, which is integrated in the right armrest of the operator's seat, plays a key role in making the TUCANO so user-friendly and comfortable for the operator. The CMOTION has been specially developed for ergonomic operation by the right hand. The innovative, three-finger control concept allows several functions to be controlled intuitively without having to reposition one's hand.

- 1 Extend grain tank discharge auger
- 2 Retract grain tank discharge auger
- 3 Grain tank offloading on / off
- 4 Cutterbar stop
- 5 Reel operation
- 6 Front attachment height control
- 7 AUTO PILOT, LASER PILOT, GPS PILOT

Another toggle switch (8) is situated on the back of the multifunction control lever. With three functions assigned to it, this switch enables manual lateral control of the cutterbar, changes to values in the HOTKEY menu or manual adjustment of the VARIO cutterbar table.



The choice is yours: multifunction control lever or CMOTION

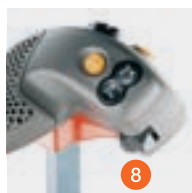

Three-function toggle switch (8)



Comprehensive information.

CEBIS is simple to use, allowing a wealth of equipment information to be displayed and printed in addition to performing full control and monitoring.

- Automatic crop setting
- GPS PILOT, LASER PILOT, AUTO PILOT – automatic guidance
- Automated cutterbar control
- QUANTIMETER – yield determination / moisture measurement
- Area counter
- Fuel consumption measurement
- Yield mapping – crop log
- Performance display – remaining diesel running time / range / grain tank fill level
- Job management
- Maintenance interval display and tasks
- On-board diagnostics, alarm lists and alarm history
- Speed monitoring, slippage display (for the threshing drum, for example)

NEW: Automatic machine setup.

Factory-programmed settings for over 35 crop types are available. In addition, users' own settings based on experience (especially relating to specific varieties) can be stored and called up whenever required. Furthermore, favourite settings can be stored and recalled quickly by means of the hotkey rotary switch. The following machine parameters are set:

- Threshing drum speed
- Concave gap
- Fan speed
- Upper and lower sieve opening
- Sieve throughput monitoring sensitivity
- Residual grain separation throughput monitoring sensitivity
- Specific crop weight (bulk density)
- Crop-specific calibration factor

TELEMATICS.

Makes good operators even better.



A full overview with just a click of the mouse.

The CLAAS TELEMATICS feature enables you to access all the important data for your combine any time, anywhere via the internet. Enjoy the benefits of TELEMATICS.

Optimise your settings.

Use your personal access to the TELEMATICS web server to quickly compare the performance and harvesting data for your machines so that you can fine tune the settings for the best results under all conditions every day.

Improve work processes.

A report with the operating time analysis and other important evaluations of the machine is sent to you by e-mail each day. This enables you to review the specific data from the previous day and determine when and how efficiently the combine operated before you start work again. In addition, the working tracks of the machine can be viewed together with the event log in order to optimise the transport logistics. TELEMATICS enables planned fleet management and helps avoid unprofitable idle time.

A range of packages to meet your requirements.

TELEMATICS is available in three different packages: basic, advanced and professional.



Simplify documentation.

Use TELEMATICS to export the relevant data to your field catalogue and save valuable time. Transfer data on area-specific yields, for example.

Faster service with CLAAS remote diagnostics.

With your consent, TELEMATICS can transmit maintenance and repair data to your CLAAS sales partner. This enables your CLAAS partner to carry out an initial analysis via CDS Remote - when required - to find the causes of faults more quickly and to make optimum preparations to assist you on site as quickly as possible.

Automatic documentation.

This function automatically documents and processes all process data. As an extension to TELEMATICS, automatic documentation transfers (without any intervention by the machine operator) the work data relating to the specific field deployment to the server, where they are interpreted and processed. Data interpretation and processing are based on the field boundaries previously uploaded from your system. Further processing is straightforward, as all machine-relevant data can be exported in IsoXML format.

More potential when you need it.



Fast data processing.

With its extremely fast on-board network, the TUCANO is already prepared to meet the far-reaching challenges of the future.



A wealth of information can be printed whenever required.



The working tracks picked up by GPS can also be displayed in CEBIS.

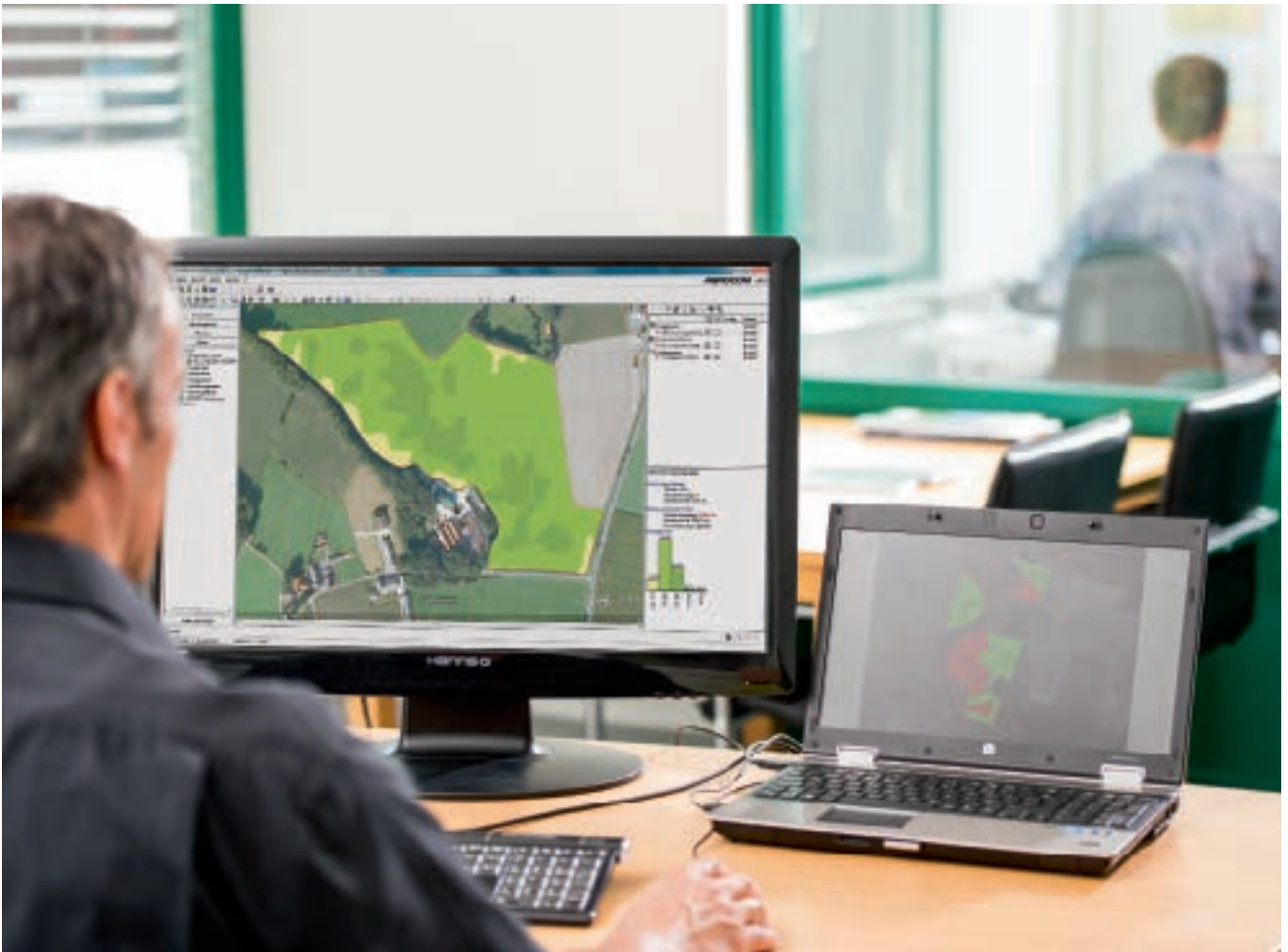

Yield mapping.

Building on the foundation of the job management functions, you can use your TUCANO to perform yield mapping. Sensors in the TUCANO measure the yield and grain moisture while CEBIS adds geographic coordinates using GPS satellite data.

All measurements are stored on portable chip cards to facilitate transfer. AGROCOM MAP START software is included to enable you to produce informative yield maps to use as a basis for your future production strategy.

Job management.

You can manage your jobs with CEBIS. Moreover, with AGROCOM MAP START software from CLAAS you can prepare customer and parcel data to be run and processed with CEBIS.

- All data is backed up when a specific task is completed or the working day comes to an end
- The data can be printed out on the combine or transferred with a data card
- All data can be viewed and processed further on a PC
- Daily counts, crop counts and total counts can also be displayed and printed in CEBIS

More precise guidance.

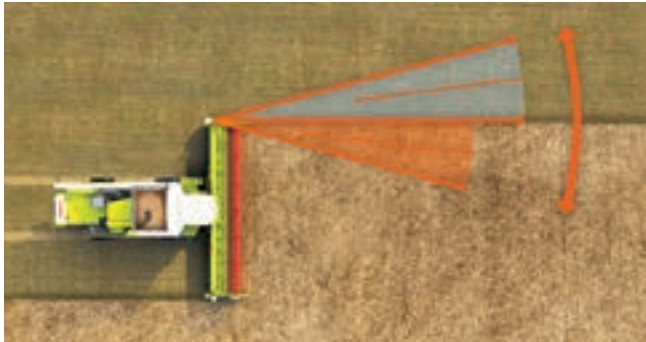

LASER PILOT.

The electro-optical sensors of the LASER PILOT use pulses of light to scan between the crop and stubble and guide the TUCANO automatically along the edge.

The LASER PILOT can be folded away for transport and is available for both the left and right side of the cutterbar. Its optimal positioning on the cutterbar side close to the crop edge enables a good viewing angle and ensures high functional reliability even with laid crops and slopes.

AUTO PILOT.

Two digital sensors, incorporated in one of the picker units, record the position of the TUCANO and automatically guide it on the best path through the rows of maize in all field conditions. In this way, AUTO PILOT contributes to greater performance and efficiency.

Choose from three automatic guidance systems.

All the TUCANO models can be factory-fitted with three automatic guidance systems which can be selected as needed according to application.

- GPS PILOT – the satellite-supported guidance system
- LASER PILOT – the electro-optical guidance system
- AUTO PILOT – the electro-mechanical guidance system

The way you want it.

Portable displays from CLAAS offer a flexible control option for ISOBUS and guidance systems. The terminal can also be moved from one tractor or self-propelled harvester to another, depending on the season or job in hand. Fit your TUCANO with the equipment you need, straight from the factory or as a retrofit option:

- S10: high-resolution 10.4" touchscreen terminal with guidance and ISOBUS functions: up to four cameras can be viewed
- S7: high-resolution 7" touchscreen terminal with guidance functions



LASER PILOT

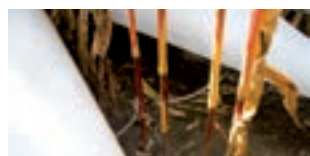

AUTO PILOT



Automatic steering at the headland.

The AUTO TURN function takes care of turning manoeuvres at the headland. The direction of the turn and the next track to be worked are pre-selected on the terminal. The steering system does the rest.

How you benefit.

- High functional reliability and safety regardless of visibility conditions
- Optimal use of the full width of the cutterbar
- Greater precision for mapping areas and yields
- Reduced fuel consumption
- Reduced turning times
- Increased seasonal performance
- Significant reduction in workload for the operator, enabling greater concentration on threshing

GPS PILOT FLEX.

The GPS PILOT can be used not only with hydraulically actuated steering, but also with the GPS PILOT FLEX automatic steering wheel. This steering wheel allows you to operate the machine with a high degree of accuracy. The great advantage of the GPS PILOT FLEX is its versatility.

- No need to touch the hydraulics
- Guidance system can quickly be moved between different machines

The electric steering wheel transfers steering commands from the terminal and navigation controller to the steering axle in order to steer the machine



GPS PILOT FLEX steering wheel

A real all-rounder.
Top performance with all crops.

The TUCANO can handle whatever
work you've got planned.





VARIO cutterbar with rapeseed equipment



VARIO cutterbar



FLEX soybean cutterbar:



CONSPEED / CONSPEED LINEAR



CERIO / standard cutterbar



Folding cutterbar



SWATH UP



SUNSPEED



It's all about higher throughput.



The leader in versatility and flexibility.

The TUCANO was developed to unite a wide variety of features at the highest level. Offering optimal throughput performance and long-term reliability combined with great versatility and minimal setup time, the TUCANO is simply unbeatable. Our top combine harvesters were the prototypes for this model. Take advantage of a unique combination of sophisticated performance features and equipment.

The V channel.

With the flexible positioning of the cutterbar mount, the V channel facilitates fast, easy adjustment of the cutting angle. This ensures optimal adaptation to all field conditions and different types of tyres.

MultiCoupler.

The central coupling for all hydraulic and electrical cutterbar functions.

- You gain valuable time due to shorter attachment and removal procedures
- No danger of confusion thanks to the integrated design
- Easy to connect, even under pressure
- Environmentally friendly with no oil leakage



That familiar comfort and convenience

Central locking system.

A single lever on the left side of the cutterbar operates all locks simultaneously.

- Safe, fast locking mechanism
- Fast, easy cutterbar attachment and removal

Replacement knife bar and crop lifters.

All CLAAS cutterbars are factory-equipped with a replacement knife bar. The knife sections are made of hardened material and are therefore extremely durable.

The use of crop lifters enables loss-free pickup of laid crops in particular while reducing the intake of stones. Crop lifter replacements can be carried conveniently on the rear side of the cutterbar.

Hydrostatic reel drive.

A variable displacement pump on the basic machine supplies a maximum torque of 1000 Nm at the reel. The reel speed is automatically adjusted independently of the ground speed.

- Plenty of pulling power thanks to high torque
- Greater efficiency than gear pumps
- A closed hydraulic circuit ensures better reel rotation
- Fast adjustment of the reel speed



The trailer for road transport.

Everything to save you time: The trailer provides compact, convenient and safe storage for the cutterbar. It is locked in seconds with two bolts.

Made-to-measure compartments are provided to transport the accessories you need for the rapeseed equipment. The rubber-coated floor ensures non-slip, protective, theft-proof storage.

Adjustable stripper rails.

The spacing between the stripper rails and the intake auger can be conveniently set externally on the V 930, V 770, CERIO 930, CERIO 770, C 490, C 430 and C 370 cutterbars.

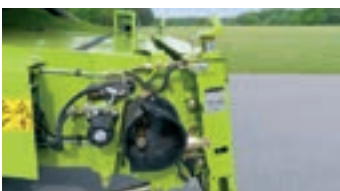

Hydraulic reversing
on the feeder housing



Adjusting the stripper rails

The TUCANO is extremely versatile.
Rapeseed and grain.



A first-class combination for a unique competitive edge.

The TUCANO is the first combine harvester to unite a machine of the mid-sized class with the VARIO high-performance cutterbar. This is a unique combination from which you will reap the benefits every time you use it:

- Highest throughput due to particularly even crop intake
- The VARIO is available in five different cutting widths: V 540, V 600, V 660, V 770 and V 930
- The hydrostatic reel drive comes equipped with automatic speed adjustment
- Reliable and rugged: the multifinger intake auger

Consistent crop flow to enhance performance.

The VARIO high-performance cutterbar feeds the crop uniformly to the threshing unit. This is the only way to increase performance and to utilise the full design capacity. Furthermore, it reduces fuel consumption and supports the operator in significantly increasing productivity.



- Automatic reel speed
- Automatic reel height
- Automatic reel levelling
- Automatic table positioning

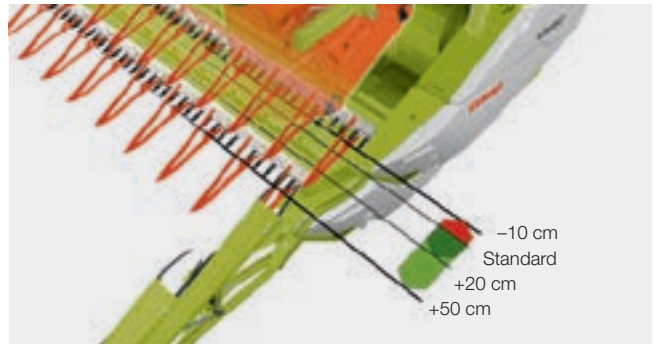

You also benefit from the following additional advantages:

- High RPM stability in the engine, threshing and separation units and during the cleaning process
- Extremely consistent performance
- No load peaks in the threshing equipment
- Protection of the drives
- Enhanced reel design with optimised reel tine carriers and bearings for significantly reduced risk of wrapping
- Hydraulic pump for rapeseed knives that can be switched on and off to reduce the power required and so reduce wear
- Overload protection features protect against damage

Rapeseed requires particular attention.

Ripe rapeseed pods need careful handling during threshing because they often burst, causing grains to scatter in all directions. This is why the rapeseed deflector and extension are indispensable parts of the rapeseed equipment on VARIO cutterbars: they serve to keep losses to a minimum. The rapeseed equipment is stored in a lockable box on the trailer for road transport, thus saving a great deal of weight on the cutterbar.

The right cut.

For grain harvesting, the cutterbar table can be extended by up to 20 cm or shortened by as much as 10 cm to keep the crop flow even and ensure efficient, trouble-free working.

For rapeseed, the cutterbar table can be moved forward by 50 cm. Once the rapeseed plates are inserted, the rapeseed table is ready for immediate use.

Hydraulically driven side cutters on the right and on the left (the latter can be switched on and off at will) can be fitted quickly and easily without additional tools.

The knife bar comes with an integrated hydraulic drive.



Knife position
-10 cm



Knife position
+20 cm



Knife position
+ 50 cm
incl. rapeseed
plates

The new generation of CLAAS VARIO and CERIO cutterbars.

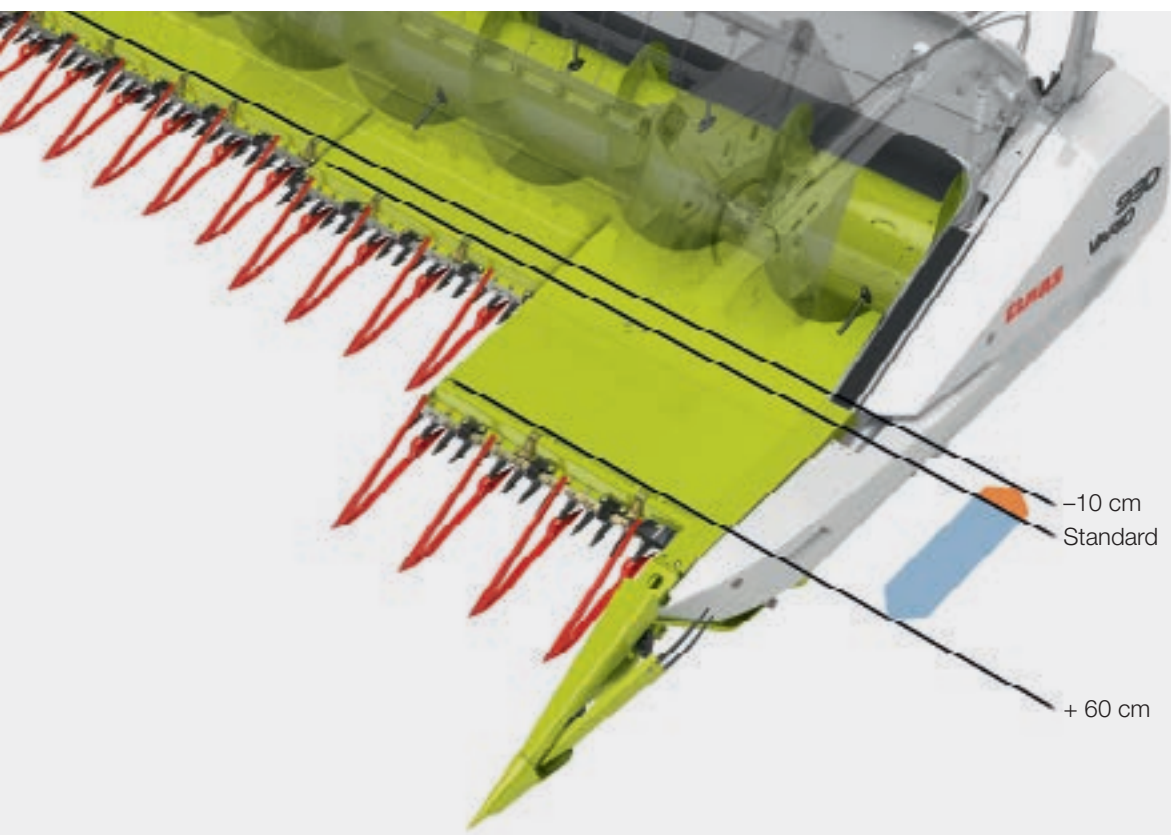

VARIO 930 / 770 – The success story continues.

With its two new models, the V 930 and V 770, CLAAS has made systematic enhancements to its proven VARIO cutterbars in order to provide increased throughput, a better crop flow, high reliability, a reduced maintenance requirement, greater flexibility and more comfort/convenience.

The highlights at a glance.

- Integrated rapeseed plates allow infinite adjustment within a range of 70 cm
- Diameter of intake auger increased to 660 mm
- Intake auger and knife bar mechanically driven via gearbox and drive shaft
- Reel with optimised reel tine carriers, wear-resistant tine tube bearings and a new design to reduce stalk take-up
- Quick-release mounting system allows dividers and rapeseed knives to be fitted/removed without the need for tools
- Hydraulic pump for rapeseed knives switches off automatically
- LASERPILOT can be folded and adjusted without the need for tools
- Stripper bars adjustable from the outside
- Automatic parking position at the touch of a button
- Angled cross-tube for a better view of the cutterbar table from the cab

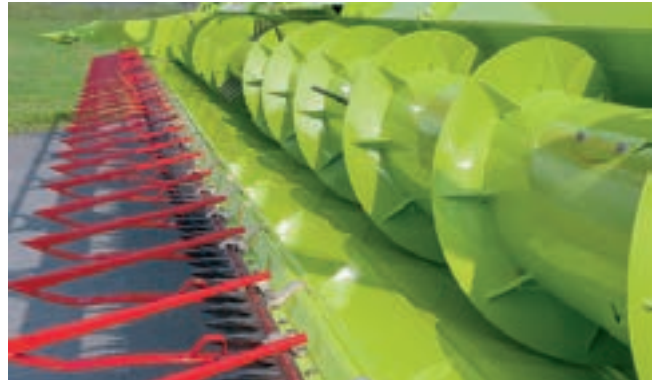
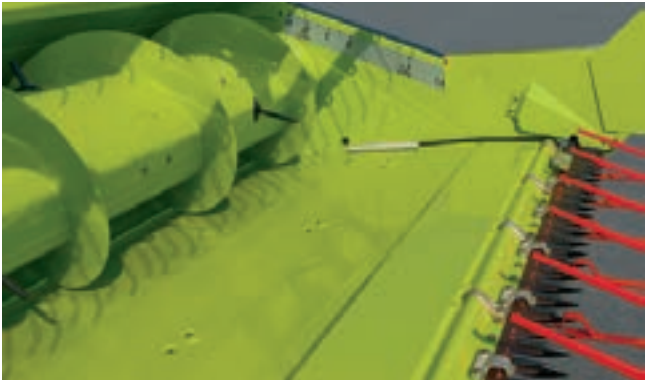

Ready for rapeseed harvesting with just a few adjustments.

Converting the V 930 and V 770 cutterbars to harvest rapeseed takes only a matter of minutes. The process involves nothing more than replacing the dividers with the rapeseed knives – a task which can be carried out without the need for tools thanks to the two quick-release mounts. Inserting the rapeseed knives automatically activates the hydraulic pump which drives the side knives. The connection is made simply by means of two flat-seal connectors. An additional cover is fitted on the right-hand side to keep the losses in rapeseed to a minimum.

The end positions of the table and reel are also transmitted automatically from the cutterbar to the combine. Even with the rapeseed equipment fitted, the table can be extended or retracted by 20 cm. The rapeseed knives are carried in a box on the transport trailer and are therefore available for use at any time.

NEW: CERIO 930 and CERIO 770.

Based on the new VARIO cutterbars, the CERIO model series is an alternative for grain harvesting. The table of the CERIO cutterbars can be adjusted manually from – 10 to + 10 cm in order to optimise the crop flow. The adjustment is made by loosening ten bolts in order to allow the table to slide in or out.

The entire frame, the intake auger, the drives and the reel of the CERIO cutterbars are identical to those of the VARIO model series. Similarly, the CERIO cutterbars are equipped with the automatic reel parking function.



The dividers and rapeseed knives can be secured without the need for tools



Fitting the rapeseed knives



Adjusting the table length of the CERIO 930 and 770

More picking power.



Committed to higher picking performance: CONSPEED and CONSPEED LINEAR.

Picking at a high rate while handling the ears of maize gently has a critical influence on the combine's throughput. The CONSPEED and CONSPEED LINEAR maize pickers meet these requirements and are optimally adapted to the performance of the TUCANO. The display of the snapping plate spacing in CEBIS is also ideal.

Make the most of the maximum efficiency of the CONSPEED:

- Snapping rollers with tungsten carbide coated knives
- Electrohydraulic snapping plate adjustment
- Horizontal chopper
- Reliable drives using only shafts and gears
- Durable, non-corroding plastic covers
- Automatic machine guidance via AUTO PILOT
- Simple rpm adjustment
- Can be adapted to all field conditions



The CONSPEED principle:
conical snapping rollers.

Each picker unit has a compact, integrated gearbox for the snapping rollers, intake chains and the chopper. Each drive unit is individually protected against overload. The picker speed can be adjusted continuously using a front attachment variator. The conical snapping rollers are a particular feature of the CONSPEED. They first pull the maize plants down slowly so the ears contact the snapping plate slowly. The rest of the plant is then drawn down quickly. This design ensures a high picking rate with careful handling of the ears and low grain loss.

Convenient transport to the field and back.

The individual picking units of the hinged 6 and 8-row CONSPEED and CONSPEED LINEAR fold in hydraulically to a transport width of only three metres. This operation is performed from the cab.



The CONSPEED LINEAR principle:
linear snapping rollers.

The CONSPEED LINEAR maize picker is driven by spur gears which provide six different picker speeds simply by exchanging two gearwheels. The straight, linear snapping rollers are set forward and are thus particularly rugged.

CONSPEED LINEAR sunflower kit.

The CONSPEED LINEAR maize picker can be converted for sunflower harvesting with a kit. This involves mounting knives over the snapping rollers as well as adding lateral cover extensions and an attachment on the back of the CONSPEED. The chain is turned and the guide changed.



A horizontal rotating knife under each snapping unit chops stalks finely so they will decompose quickly.

More flexibility.



The effective SUNSPEED principle.

The SUNSPEED sunflower cutterbar was developed with the goal of achieving maximum output per unit area with the lowest losses. Particular attention was paid to keeping set-up times as short as possible and making the system extremely easy to operate.

The sunflower stems are first captured by the shuttles. An adjustable guide plate ensures that the sunflower heads are pushed to the front. At the same time, the snapping roller under the knife bar pushes the stalks down. It is impossible for them to be cut too early as this only takes place once the special reel has captured the sunflower heads. The precisely cut heads are then passed to the intake auger and feeder housing. The entire process is conducted on a row-independent basis in the most diverse harvesting conditions and ensures a high level of grain cleanness and low wear.

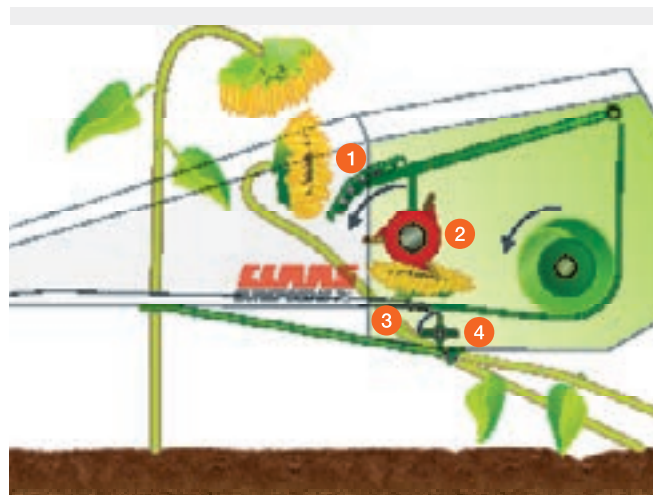

- 1 Adjustable guide plate
- 2 Reel
- 3 Knife bar
- 4 Snapping roller



Snapping roller



SUNSPEED adapts.

- Reel height and speed can be adjusted hydraulically
- Adjustable guide plates keep the stalks securely positioned so only the sunflower seed heads are harvested
- The gap between the shuttles can be adapted to the relative stalk diameter via adjustable rails – nothing gets jammed and harvesting runs like clockwork
- The angle of the shuttles is also adjustable, so they can be adapted to the most diverse harvesting conditions

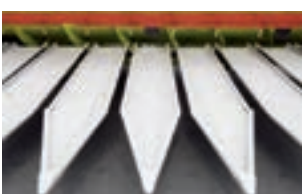

Adjustable shuttles

The specialist: SWATH UP.

In areas which are unsuited to direct threshing the TUCANO once again proves its reliability under all imaginable conditions. The SWATH UP enables nearly all windrowed crops to be picked up. This is an extraordinarily efficient concept, particularly for crops such as rapeseed and grass seed.

Perfect pick-up at high speeds.

Two consecutive conveyors pick up the crop. The first belt equipped with plastic tines ensures a clean pick-up; the second belt then conveys the crop flow to the intake auger. Thanks to the large overlap between the two belts, the crop reaches the feeder housing without any losses. The straightforward design ensures long operating times and a low maintenance requirement.

More expertise for rice and soybeans.



Dual blade knife bar.

Rice stalks are extremely tough. To achieve clean, top quality cutting results at a high rate in this hard, unforgiving crop, all the rice cutterbars are equipped with a dual blade knife bar. The specially hardened knife blades are particularly durable. A rice harvesting system is available as a retrofit kit for the new VARIO and CERIO 930 and 770 cutterbars.



Hardened intake auger.

The intensive irrigation of rice fields leads to high levels of dirt particles on the plants, which is particularly tough on combines during harvesting operations. To protect against wear, the edges of the hardened intake auger are sintered. Special deflectors on its sides reliably prevent wrapping. Altogether, these features ensure smooth crop flow and high throughput.

The two new VARIO 930 and 770 cutterbars are also available as HD versions.



Hardened intake auger

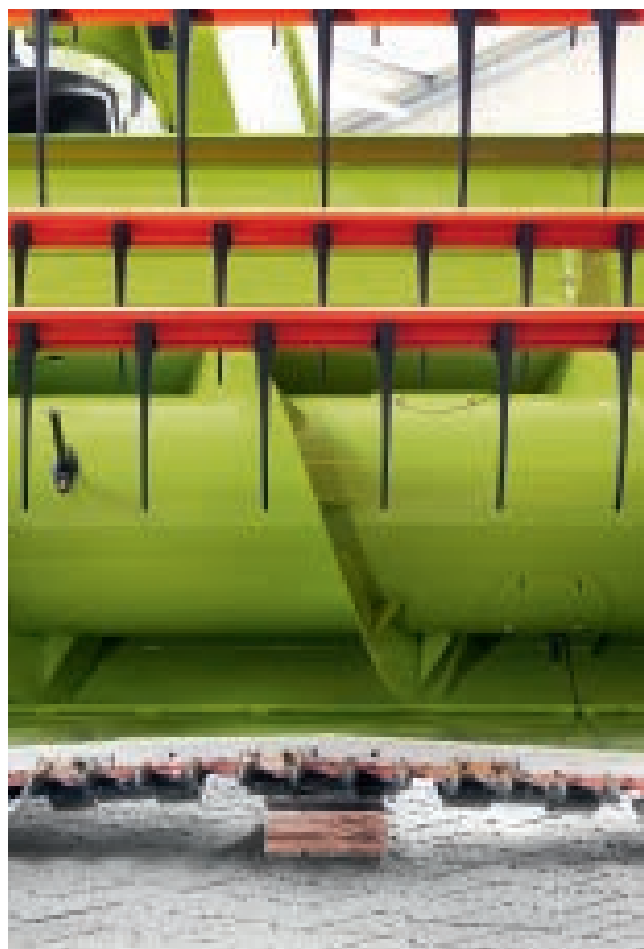

FLEX: down-to-earth quality.

Legumes such as soybeans grow in pods close to the ground. Thus to prevent substantial losses during harvesting, the crops must be cut as close as possible to the ground to ensure that every last pod gets picked up by the machine.

FLEX cutterbars from CLAAS are equipped with a flexible knife bar which compensates automatically for the slightest ground contours. The knife bar can flex up to 100 mm. Together with the V channel, it enables intake losses to be avoided under all field conditions.

These cutterbars are also suited for peas and other specialised crops such as clover.

Special crop dividers.

The FLEX cutterbars are equipped with special crop dividers which can be deflected vertically, thereby avoiding damage and preventing interruptions to the harvesting process.

A versatile operator.

The FLEX cutterbars also offer outstanding flexibility thanks to the knife bar which can be set to rigid mode manually, thus allowing it to be used for other crops, such as grains.

More intelligence for the cutterbar.

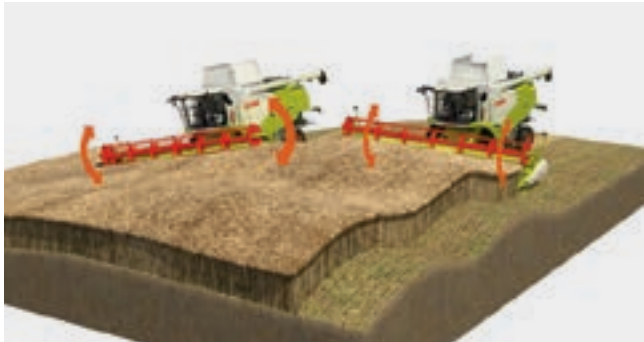

CLAAS CONTOUR ensures excellent adaptation to ground contours.

The cutterbar with CLAAS CONTOUR adjusts automatically to ground irregularities along the direction of travel. You select a contact pressure and CONTOUR ensures that it will be uniformly maintained. Every time the cutterbar is lowered, the preselected cutting height ensures that the specified cutting height is always found automatically.

AUTO CONTOUR: faster and more accurate than ever.

AUTO CONTOUR goes a step further by compensating all ground irregularities, including those which are transverse to the direction of travel. Sensor bands below the cutterbar provide early detection of undulations and trigger the corresponding cutterbar rams on the feeder housing.

- Electronic sensors detect the hydraulic pressure in the system and react quickly
- Valve-controlled, nitrogen-filled accumulators ensure optimal shock absorption with front attachments of different weights

With fully automated comparison of the current status and the setpoint, the AUTO CONTOUR adapts the cutterbar position optimally to the terrain. This greatly simplifies the work of harvesting, particularly with large cutting widths, at night, with laid crops, on side slopes and rocky ground. AUTO CONTOUR helps to increase performance and to make the use of the TUCANO pay even greater dividends.

Automatic reel control.

The RPM of the reel and thus its speed adjust automatically and proportionally to the ground speed. The operator can select and save various settings for the ratio of ground speed to reel speed. The reel speed can be adjusted continuously between forward, synchronous and after-running. A digital RPM sensor ensures absolutely exact adjustment of the rotation speed.

Different working heights of the reel can be saved and recalled for various cutting heights. But the reel height can always be adjusted directly.



2-way cutterbar rams control the ground pressure precisely.

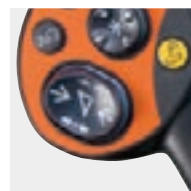

The automatic cutterbar control is activated simply by pressing the button for height adjustment on the multifunction control lever.



VARIO automation.

The VARIO cutterbar with automated reel control enables the reel levelling and table position to be saved and recalled by activating the automatic cutterbar control. Manual adjustments can also be made.

Parking position for the V 930 and V 770.

A touch of a button is all it takes for these two VARIO cutterbars to move into the parking position for mounting on the road transport trailer or, after coupling, to move straight into the working position. The threshing system must be switched off before this function can be used.

Automated cutterbar control.

- CONTOUR / AUTO CONTOUR
- Automatic reel speed
- Automatic reel height
- Automatic reel levelling (VARIO only)
- Automatic table position (VARIO only)
- Automatic parking position (V 930 and V 770 only)

Sensor bands detect the position of the front attachment.



APS System. Threshing technology from CLAAS.



A combination of impressive advantages unique in its class. CLAAS has redefined high performance.



APS gets good results fast. TUCANO 450 / 440 / 430 / 420.

- 1 Accelerator
- 2 Threshing drum
- 3 Impeller



Unique APS threshing system.

The distinct competitive edge of CLAAS appears well before the threshing drum. The dramatic acceleration of the crop flow from 3 m/s to 20 m/s triggers a chain of extremely efficient processes:

- The pre-accelerator separates the crop more thoroughly
- The crop flow is particularly even and up to 33% faster
- Higher centrifugal forces sort considerably more grain
- Up to 30% of all grains are already sorted in the pre-separation concave directly below the accelerator, significantly reducing the load on the main concave

Thus there is a net performance increase of up to 20% with no rise in fuel consumption. APS really pays.

Versatile pre-separation concave.

The pre-separation concave is designed as a MULTICROP concave so it can handle all types of crops. The three concave segments can be changed rapidly, minimising changeover times between crops and maximising efficiency and profitability.

NEW: Hydraulic concave adjustment.

The concave is adjusted hydraulically from the operator's seat. This allows immediate and extremely convenient adaptation to changing harvesting conditions in the course of the day. The parallel concave control ensures that optimum threshing quality is maintained.

NEW: Overload protection increases daily output.

Integrated hydraulic overload protection reliably prevents damage from foreign bodies and allows the machine to be used at full capacity without risk. The concaves are pre-tensioned hydraulically and open when pressure peaks arise. The concaves then return automatically to the set working position.

Long threshing channel with a large grain separation area.

In the CLAAS APS threshing unit, we've succeeded in wrapping the main concave much farther around the threshing drum than in conventional machines. No other threshing unit offers an angle of wrap of 151°. You benefit from gentle yet thorough threshing with a large concave clearance and low drum speed with reduced fuel consumption.



Optimal grain quality is purely a matter of the right settings.

The APS system is equipped with multistage adapters for optimal deawning. With the intensive threshing component and the deawning plates, which can be engaged in just seconds via a lever on the feeder housing, APS ensures outstanding grain quality.

Synchronised function.

The accelerator and threshing drum are driven by a central variator. Each change in drum speed causes a corresponding adjustment of the speed of the accelerator.

The result:

- Continuous protective crop handling with uniform crop flow
- No broken grains



Changing the MULTICROP pre-separation concaves

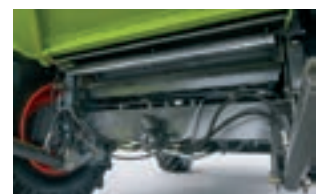

Stone trap

CLAAS threshing system.



The champion in all fields.

A high-quality threshing unit must remove and separate grains reliably in all harvest conditions. The classic CLAAS threshing mechanism provides impressive proof of its abilities time and again. Regardless of the harvesting challenges you face, it has the versatility to take them in its stride with the full threshing drum width of 1.58 m (TUCANO 340) as well as with the smaller 1.32 m version (TUCANO 320).

- The threshing unit can be easily accessed from the front via the feed rake and from both sides through large openings
- The extremely robust design of all the drives, and of the threshing drum drive in particular, ensures top reliability during the harvest.

From field beans to clover seeds: the MULTICROP concave can handle anything.

The concave below the threshing drum is designed as a MULTICROP concave with individual segments that can be changed easily. You can switch the concave quickly for a wide assortment of crops, different varieties or various stages of ripeness - always ensuring the right combination of clean threshing, protective handling of the crop and a high separation rate.

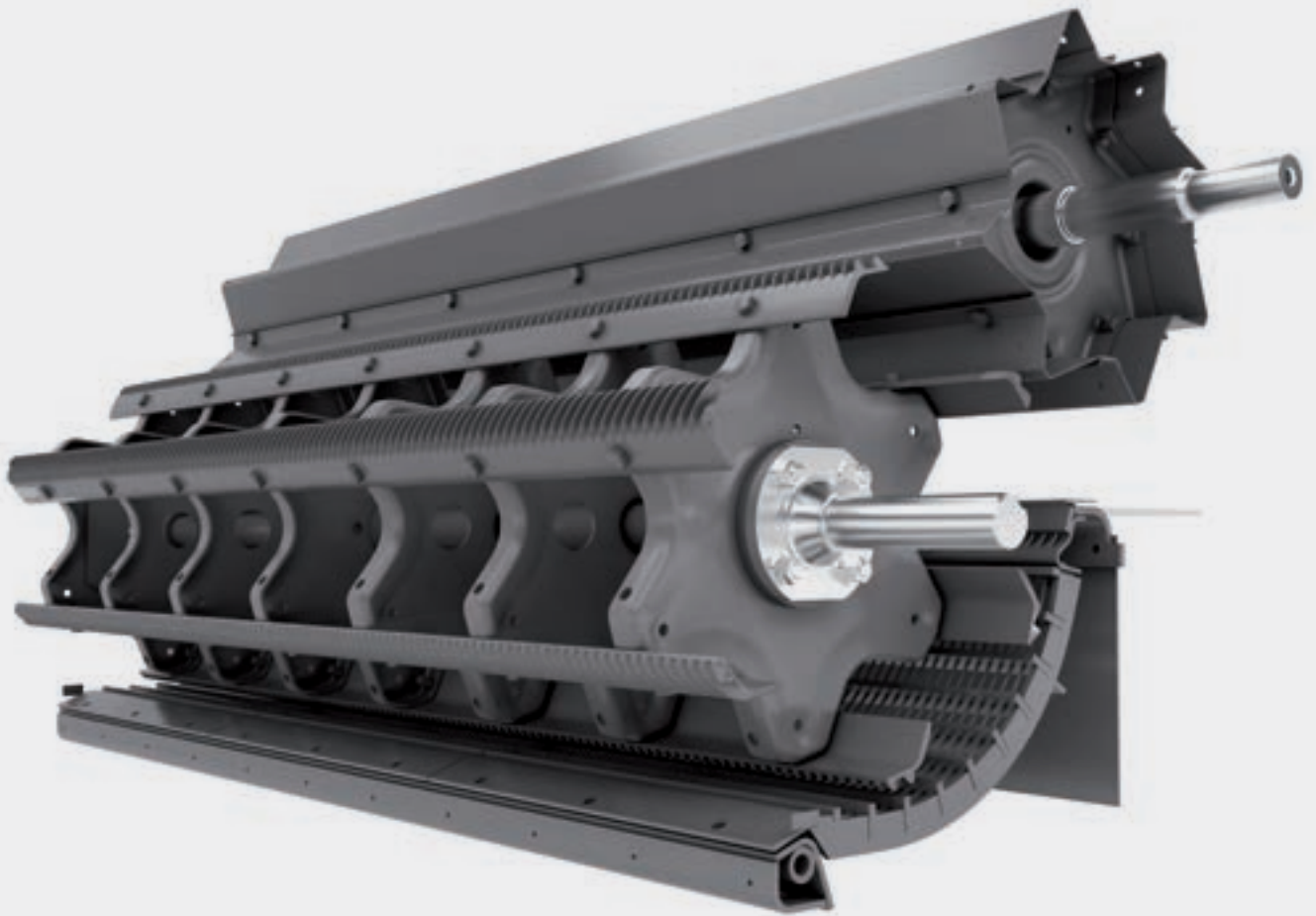

NEW: Hydraulic concave adjustment and overload protection.

In the TUCANO 340 and 320 models, the concave gap is also set in CEBIS.

The hydraulic overload protection also protects the conventional threshing system from damage by foreign bodies and blockages.

NEW: Hydraulic adjustment of the concave outlet.

In order to adjust the machine for different crop types, the concave outlet can be set to two different positions: wide for crops such as maize and beans, narrow for grain. The adjustment is made by actuating a valve near the cab door.

Changing the MULTICROP pre-separation concaves



The straw walker gets out the last 10% for you.



View of straw walkers from the rear

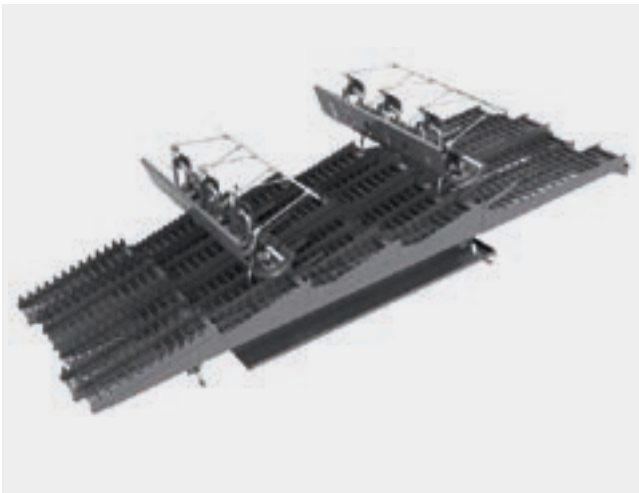

Cleanly separated over 4.40 metres length.

Grains this way, straw that way. The even flow of the straw on the 4.40 metre long, open-bottomed straw walker ensures that practically all the grain is separated from the straw. A separate returns pan sends the grains on their way to the preparation floor. Even large volumes of straw are moved with ease by the system.

Resistance is futile!
The CLAAS intensive separation system.

There are two guide-controlled agitator tines mounted above every straw walker, which actively loosen the straw from the top to ensure that it flows quickly in a thin layer. As a result, the remaining grains fall easily out of the straw, through the walker floor and onto the returns pan.



Work safely at the capacity limit with the throughput monitor.

It's easy to keep an eye on the separation and cleaning from the cab, as if through a "rear view mirror", with the CLAAS throughput monitor. It works with high-precision adjustments to adapt automatically to crops of different weights and display the results accurately.

How you benefit:

- In parallel viewing mode, you can fine-tune the combine faster by optimising the balance of the cleaning and residual grain separation functions
- The throughput monitor indicates whether you are threshing at the best forward speed
- You run safely at the performance limit of the combine

Clean work pays better.



Electric sieve adjustment

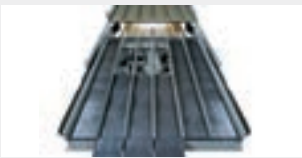

Divided preparation floor that can be pulled out towards the front



Rotary fan or turbine blowers.

- Depending on the model, there are six or four turbines or a rotary fan to ensure a consistent, uniformly distributed air flow pressure, even with variations in the sieve loading
- Forced air flow control prevents crop mat formation
- Reliable air flow even at low air speeds
- Continuously adjustable from the cab

Preparation floor.

Pre-sorting of the grains (bottom) and chaff and broken straw (top) takes place on the preparation floor. The resulting reduction in the load on the upper sieve increases the cleaning capacity. The 400 series models have a plastic preparation floor that can be pulled out towards the front.

Single or double steps.

- These significantly reduce the load on the upper sieve
- Result in increased performance, especially in the case of dry and brittle straw

Electric sieve adjustment.

Developed by CLAAS, copied by the competition.

Electronic sieve adjustment from the cab:

- Easy and convenient
- No need to exit the cab
- Immediate result monitoring

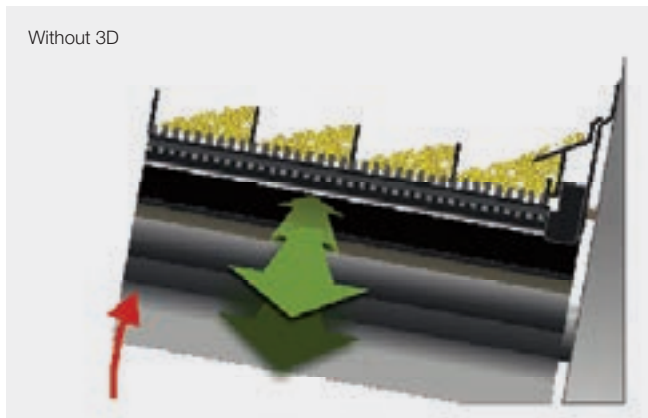
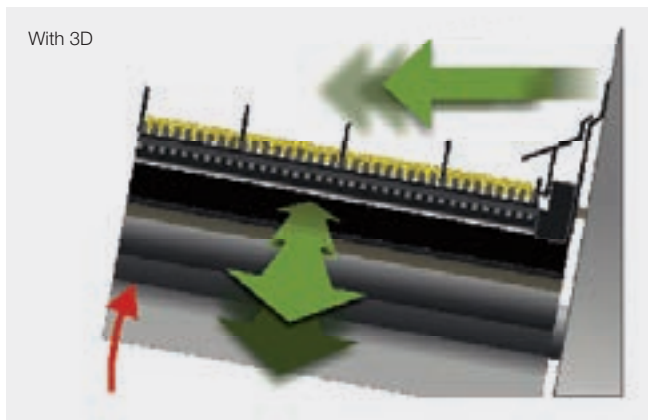
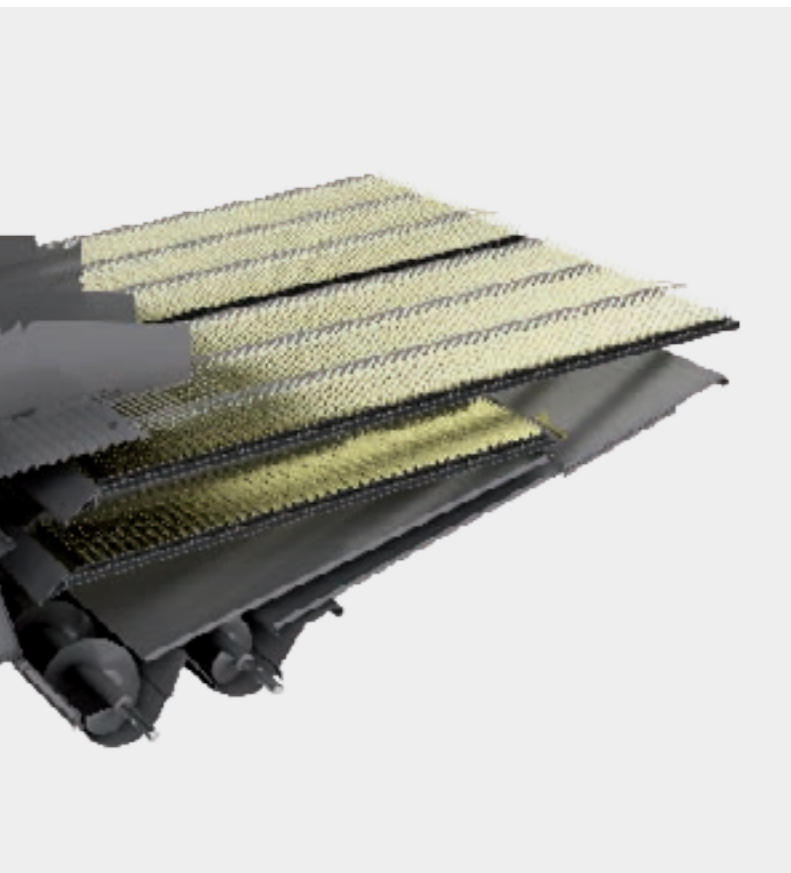

The 3D-cleaning system.

- Dynamic side slope levelling – active control of the upper sieve
- Completely consistent performance on side slopes with an inclination of up to 20%
- No wear - completely maintenance free
- Fast, simple retrofitting
- Together with the AUTO CONTOUR, it is the ideal "hillside package"



3D-cleaning system hydraulic control unit

Faster offloading.

NEW: Faster discharging.

The new TUCANO model series is equipped with the new turret auger and has a discharge rate of 105 l/s or 90l/s. With a capacity of up to 9000 l, the grain tank is emptied in less than two minutes. Furthermore, the new TUCANO has a greater discharge height and reach. As a result, even large transport vehicles can be filled without difficulty. A corresponding range of grain tank discharge augers for cutterbar widths up to 9.22 m is available.



NEW: Electric grain tank cover.

The grain tank cover can be opened by means of a switch on the armrest. It is no longer necessary for the operator to leave the cab.

Well-designed overall concept.

Many more well-thought-out details complete the overall grain tank design concept:

- Easy grain sampling
- High overhead discharge height
- Ideal weight distribution
- Good view into grain tank
- Fast, direct offloading at up to 105 litres per second
- Smooth surfaces in the grain tank facilitate complete emptying

Innovative: visual inspection of returns from the operator's seat.

- The illuminated inspection window for monitoring the returns
- Users quickly identify the combine settings which work best for them
- This facilitates optimal utilisation of the performance potential

The QUANTIMETER measures and checks.

The primary functions of the QUANTIMETER include throughput measurement, moisture content measurement and data display in CEBIS.

The throughput measurement is grain-specific. The moisture content of the crop is monitored continuously and displayed upon request.

During the volume measurement in the grain elevator, a photo cell records the filling of the individual paddles. Using appropriate correction factors, including the lateral and transverse tilt of the machine, the QUANTIMETER automatically determines the precise quantity harvested.



Wide grain tank window



Smooth surfaces in the grain tank



PROFI CAM – everything in view.

All TUCANO models can be equipped with a PROFI CAM at the end of the grain tank discharge auger tube. This camera position has been chosen precisely to allow up to three processes to be monitored simultaneously from the comfort of the cab on an additional colour display or on the S10 terminal:

- Grain tank discharge auger tube deployed: transfer process
- Grain tank discharge auger tube retracted: distribution of chopped material
- Grain tank discharge auger tube retracted: rear of machine during reversing or on-road operation

Up to four cameras can be connected to the system and simultaneously feed their images to the colour monitor or the S10 terminal in the cab.

CEBIS rear camera.

The image from the rear camera fitted on the rear hood is fed straight to the CEBIS screen. As soon as the TUCANO moves backwards, the image from the camera is displayed automatically.



CEBIS rear camera



Image from rear camera in CEBIS



Image from PROFI CAM on additional screen

Chopped short and spread wide:
your field is clear for the next harvest.



- 1 Adjustable cross-cutter
- 2 Rotor shaft
- 3 Knives
- 4 Bolt-on rasp bar
- 5 Adjustable stationary knife

Short chop, even distribution.

As it leaves the straw walkers, the straw is finely chopped and spread evenly across the full working width. The debris from the sieve pan is fed to the heavy duty chaff spreader, which then distributes it evenly over the field. The spreading distance can be adjusted easily.

SPECIAL CUT.

The SPECIAL CUT straw chopper is available for all TUCANO models as an alternative to the STANDARD CUT model. The chopper is switched on and off by a sensor-controlled electrohydraulic system as soon as the straw guide plate is operated. The SPECIAL CUT has 30% more knives: 68 for five-walker models (430 / 420 / 320) and 80 for those with six straw walkers (450 / 440 / 340). The streamlined housing ensures even feeding of the straw to keep power consumption low and spreading reliable.

Spread across the full working width: ACTIVE SPREADER (TUCANO 450 / 440 / 340).

The larger the volume of straw and the cutting width, the more precisely and evenly the straw must be spread. The ACTIVE SPREADER by CLAAS offers you the right solution.

The mixture of chopped material and chaff is grabbed while in motion by two counter-rotating spreading rotors, accelerated again and distributed over a total width of more than 9.3 metres. The direction of spreading can be conveniently controlled from the cab.

Thus, the TUCANO ensures efficient straw spreading with minimal effort. Both the ACTIVE SPREADER and the SPECIAL CUT are unique in this performance class and put the TUCANO at the very top of the upper middle segment.

The TUCANO handles straw very gently.

Take long straw, for example. Thanks to the protective threshing and separation process, the straw retains its full original structure, which is ideal for high-quality bedding straw. When the chopper is switched off, the swath is layered loosely, allowing it to dry quickly and be compacted easily into firm bales.



If you need a chaff spreader,
you'll want the HD.

There are many advantages:

- Suitable for corn and grain – no changeover necessary
- HD components for a longer service life
- Outstanding spreading width
- Consistent crop feed in all conditions
- No influence on the cleaning air flow
- Optimal ease of access to the sieve pan with folding chaff spreader

Swath former on the deflector



Swath former on the ACTIVE SPREADER



Electrohydraulic actuation of the straw chopper



CLAAS POWER SYSTEMS.

Optimal drive for maximum performance: CPS.

At CLAAS, machine development means an ongoing effort to achieve even greater efficiency and reliability as well as greater profitability in the field.

Of course, this applies to all aspects of a CLAAS combine harvester. The drive system is of decisive importance – and requires much more than just a powerful engine.

In CLAAS POWER SYSTEMS, we have brought together the best components to create a drive system in a class of its own. One that always delivers the greatest power when needed. Ideally matched to the work systems and with fuel-saving technology that quickly pays for itself.

It goes without saying that the TUCANO also embodies this development philosophy: the experience gained through 75 years of combine development has resulted in the best ever CLAAS drive system that delivers the best working results.

More technological landmarks and engineering refinements: for maximum reliability even under extreme conditions. The TUCANO is ready.

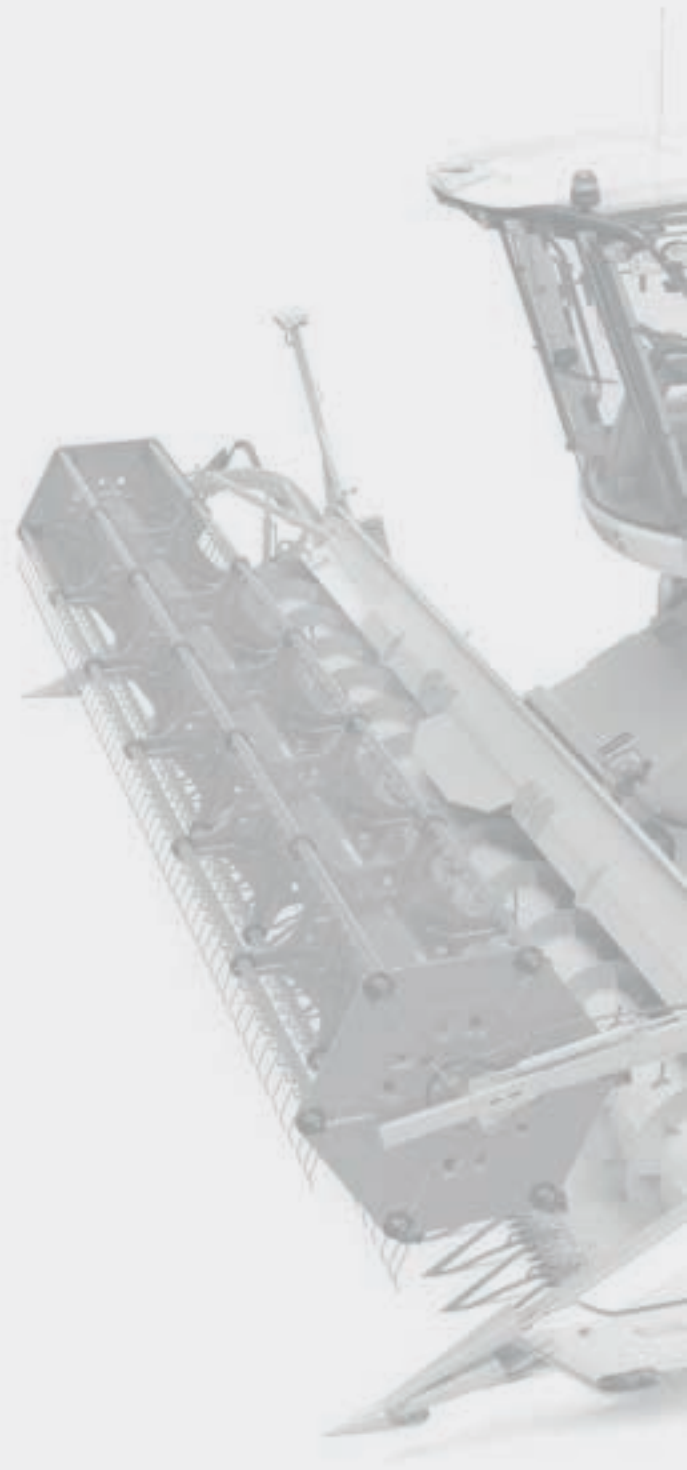



CPS | CLAAS
POWER
SYSTEMS

Increased engine output with high efficiency.

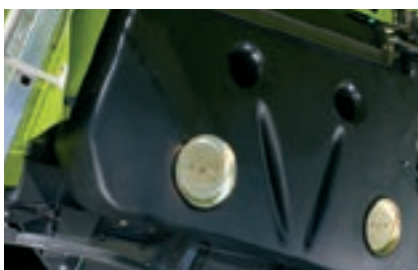

Fuel tank with capacity of up to 650 l.



Three batteries for the TUCANO: two are wired in series for the 24-volt engine electronics, one supplies power to the 12-volt on-board electronics.



No compromises on power or endurance.

The 7.7-litre high-performance engine in the TUCANO complies with the Tier 4 emissions standard thanks to an exhaust aftertreatment system and cooled exhaust gas recirculation (EGR). In addition, the engine output of all TUCANO models has been increased.

Conversion of nitrogen oxides by SCR and EGR.

The Mercedes-Benz engine in the TUCANO complies with the standard thanks to a selective catalytic reduction (SCR) exhaust aftertreatment system. This process converts the nitrogen oxides in the exhaust flow into pure nitrogen and water. The urea solution necessary for this is carried in a 57-litre tank. A further reduction in nitrogen oxides is achieved by cooled exhaust gas recirculation (EGR).



Larger cooling system with automatic dust extraction.

The TUCANO works with an extremely efficient common cooling system for the engine, the hydraulic system and the climate control system. The radiator frame has been enlarged to deliver a significant increase in cooling power. The automatic dust extraction facilitates continuous cleaning of the hydraulically rotating radiator frame and thus enables optimal cooling performance. Soiling of the cooling ribs is significantly reduced.

NEW: Air intake and air filter.

Fresh air for the engine of the new TUCANO is first drawn in by the rotating radiator screen. Thanks to the active pre-separation process, few particles reach the two air filters, the size of which has been increased considerably for the new engine. These important improvements allow maintenance intervals to be extended significantly and downtime to be reduced drastically.



For more information, please visit: tucano400-300.claas.com

More power under all conditions.

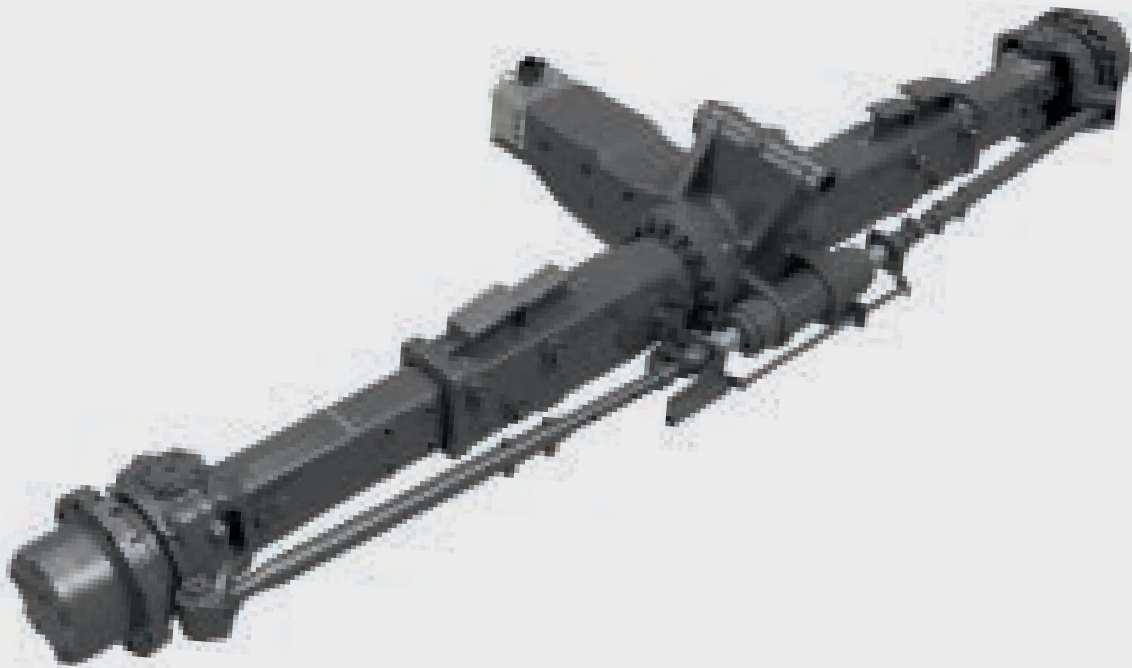

NEW: 4-TRAC all-wheel drive.

You can control the hydrostatic ground drive of the TUCANO – without operating a clutch or having to change gear – very easily and conveniently with the multifunction lever. Such operating comfort and convenience directly enhances performance with faster turns and precise adjustment of the travel speed to changing field conditions. Your choice for added power: all-wheel drive. A simple touch of a button switches to a hydraulically driven power system which keeps you moving forward even in the most adverse terrain. The all-wheel drive is reliable and maintenance-free.

NEW: 30% more traction from the all-wheel-drive axle.

The new all-wheel-drive axle has two central hydrostatic motors which are integrated in the axle and are characterised by significantly greater efficiency. The integrated design means that there are far fewer external hydraulic lines. Less dirt can be deposited in wet conditions and the risk of damage to the drive is reduced to a minimum.

NEW: Larger tyres for the all-wheel-drive axle.

For even greater traction in difficult conditions and reduced ground pressure, 600/65 R 28 or VF 620/70 R 26 tyres are available (TUCANO 450 and 440). These two tyre options can be combined with certain tyres with a width of 800 mm.





NEW: Central lubrication system.

The central lubrication system supplies grease to practically all lubrication service points as required. Lubrication points and intervals only need to be programmed once. This system differs from individual manual lubrication in that the grease is distributed to the lubrication service points from a central reservoir.

How you benefit:

- Reliable and controlled lubrication of all points while machine is running
- Service life of pins and bearings is extended
- Cost savings through reduced grease consumption and reduced wear
- Reduced maintenance work and costs

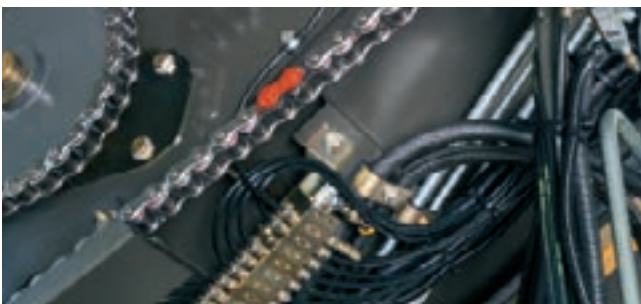

All the traction you need.



Tyre technology for long-term ground protection.

Intensive joint efforts between CLAAS and renowned tyre manufacturers have led to the development of this tyre technology.

How you benefit:

The tyres improve mobility on the road. Their greater contact area provides more traction, less slippage and lower fuel consumption for travel, while the lower tyre pressure reduces ground compaction and so makes a long-term contribution to improving soil structure.



Reduced transport width with increased contact area



Tyre size		Standard tyres	MICHELIN CerexBib
680/85 R 32	bar	2.9	1.8
800/70 R 32	bar	2.4	1.6

Tyre size		Standard tyres	SVT CHO Continental
800/70 R 32	bar	2.4	1.6



Facts and figures:

- Tyre pressure can be reduced by between 0.6 and 1.1 bar with full load capacity compared to standard tyres of the same size – this represents a reduction of 35%
- The tyres have the contact area of standard tyres two sizes larger, providing 22% more ground contact with the same transport width
- Tyres on drive axle: 800/70 R 32 and 680/85 R 32, tyres on steering axle: 620/70 R 26 and 520/80 R 26

Maintenance. Could you do with less of it?

- Pivoting radiator frame for fast manual cleaning
- Large, continuous side doors for unimpeded access
- Easy access to the engine compartment and other maintenance areas with a mobile, foldable ladder
- Fully folding rear hood
- Compressed air system
- Lubrication banks
- Storage box for hand tools, for example
- Long service intervals



Accessibility, right side



Accessibility, left side

More service from us. More success for you.



In the best hands.

CLAAS dealers are among the most efficient agricultural technology companies in the world. Our service teams are ideally qualified and equipped with the all-important special tools and diagnostic systems. CLAAS Service stands for high-quality work which meets all your expectations with regard to expertise and reliability.

CLAAS ORIGINAL. Long live your machine.

Members of the First CLAAS Service teams from CLAAS sales partners worldwide are available round the clock to provide a full spare parts supply and reliable service. They are on hand to assist you at any time, with expert knowledge, experience and a genuine commitment to you and your machine, and can also supply CLAAS ORIGINAL parts, characterised by top quality, superb function and a long service life, within very short timeframes.

We're there for you wherever you need us.

Our central parts warehouse in Hamm (Germany) delivers all CLAAS ORIGINAL parts quickly and reliably all over the world. The dense network of CLAAS dealers around the world ensures that parts reach their destination as quickly as possible – wherever you happen to be.

Invest in the best. Invest in success!

Increasing cost pressure and narrow timeframes during the harvesting season call for measures with which you can ensure the availability of your machine – far beyond the first twelve months covered by the statutory warranty. With this in mind, CLAAS offers individual service products with easily predictable costs which ensure that you can count on a high degree of reliability and efficiency. With the CLAAS post-harvest check, maintenance contract and MAXI CARE (warranty extension) service products we can tailor a service package to meet your specific requirements. This allows you to work on the basis of predictable costs while minimising the risk of a machine breakdown.

TELEMATICS.

Thanks to TELEMATICS, our service staff have access to all the performance and electronic data of your CLAAS machine via GPRS and the internet. This means that problems can often be resolved remotely, thus reducing annoying downtime.





The TUCANO 400 at a glance.





- 1 GPS PILOT S7 or S10, GPS PILOT FLEX
- 2 Comfort cab
- 3 CEBIS with automatic crop setting
- 4 Turret auger delivering up to 105 l/s
- 5 LASERPILOT
- 6 VARIO cutterbars / NEW: VARIO 930 and 770 with integrated rapeseed plates
- 7 AUTO CONTOUR
- 8 MultiCoupler
- 9 V channel
- 10 APS threshing system
- 11 Hydraulic concave adjustment for all models
- 12 Hydraulic concave overload protection
- 13 Turbine fan
- 14 Intensive separation system
- 15 HD chaff spreader
- 16 SPECIAL CUT chopper
- 17 ACTIVE SPREADER
- 18 PROFI CAM
- 19 Mercedes-Benz engines with Tier 4 emissions standard
- 20 All-wheel-drive axle with new drive concept

The TUCANO 300 at a glance.





- 1 GPS PILOT S7 or S10, GPS PILOT FLEX
- 2 Comfort cab
- 3 CEBIS with automatic crop setting
- 4 Turret auger delivering 90 l/s
- 5 LASERPILOT
- 6 VARIO cutterbars / NEW: VARIO 930 and 770 with integrated rapeseed plates
- 7 AUTO CONTOUR
- 8 MultiCoupler
- 9 V channel
- 10 CLAAS threshing system
- 11 Hydraulic concave adjustment for all models
- 12 Hydraulic concave overload protection
- 13 Radial blower
- 14 Intensive separation system
- 15 HD chaff spreader
- 16 SPECIAL CUT chopper
- 17 Straw spreader
- 18 PROFI CAM
- 19 Mercedes-Benz engines with Tier 4 emissions standard
- 20 All-wheel-drive axle with new drive concept

The power of persuasion.
A wealth of impressive features.



Cab.

- The sound-insulated, spacious VISTA CAB provides an exceptionally quiet environment which allows you to focus on your work
- Visual returns checked from the operator's seat through the lit inspection window
- CMOTION, the multifunction lever, CEBIS, TELEMATICS, yield mapping and GPS PILOT ensure innovative and convenient control and performance monitoring

Cutterbars.

- VARIO cutterbars in widths up to 9.22 m give up to 10% better performance by optimising the crop flow
- AUTO CONTOUR is an intelligently controlled cutterbar which automatically compensates for undulations in the direction of travel as well as those in the transverse direction
- Especially versatile thanks to the standard and VARIO cutterbars, CONSPEED, SUNSPEED, RAKE UP, folding cutterbar and FLEX cutterbar
- New VARIO V 930 and V 770 cutterbars with an adjustment range of 700 mm thanks to integrated rapeseed plates

Threshing technology.

- Up to 20% more throughput with the APS threshing system
- 7/18 concave for maximum separation, optimised grain quality and reduced returns
- APS. A threshing technology unique in its class
- 3D-cleaning system for slopes up to 20%
- The grain tank capacity of up to 9000 litres reduces offloading frequency in the field while the high offloading rate reduces the time to empty the tank. Together, these features considerably increase your daily output
- ACTIVE SPREADER for precise, even straw distribution over the entire working width

CPS – CLAAS POWER SYSTEMS.

- Mercedes-Benz OM 936 offers reliable reserves of power for the most demanding field conditions
- Tyre technology for optimal ground protection with a limited transport width
- New all-wheel drive axle with 30% more traction
- Easy and convenient access to maintenance points
- First CLAAS Service around the clock

TUCANO		450	440	430	420	340	320
Threshing system							
APS acceleration and pre-separation		●	●	●	●	–	–
Accelerator rpm		80% of the threshing drum				–	–
MULTICROP		●	●	●	●	●	●
Drum width	mm	1580	1580	1320	1320	1580	1320
Drum diameter	mm	450	450	450	450	450	450
Drum speed	rpm	650–1500	650–1500	650–1500	650–1500	650–1500	650–1500
with reduction gear	rpm	280–1500	280–1500	280–1500	280–1500	280–1500	280–1500
7/18 concave		○	○	○	○	–	–
Pre-separation wrap angle	degrees	60	60	60	60	–	–
Concave wrap angle	degrees	151	151	151	151	121	121
Externally folding deawner plates		●	●	●	●	–	–
Hydraulic concave adjustment		●	●	●	●	●	●
Large stone trap		●	●	●	●	●	●
Residual grain separation							
Straw walkers	number	6	6	5	5	6	5
Straw walker steps	number	4	4	4	4	4	4
Straw walker length	m	4.4	4.4	4.4	4.4	4.4	4.4
Straw walker area	m ²	7	7	5.8	5.8	7	5.8
Separation area	m ²	8.75	8.75	7.26	7.26	8.17	6.78
2 intensive separation systems		●	●	●	●	●	○
Crop cleaning							
Removable preparation floor		●	●	●	●	●	●
Fan		6-turbine	6-turbine	4-turbine	4-turbine	6-turbine	Radial blower
Fan adjustment, electric		●	●	●	●	●	●
Dual ventilated step		●	●	●	●	–	–
Divided, counterdirectional sieve pan		●	●	●	●	●	●
3D-cleaning system		○	○	○	○	○	○
Total sieve area	m ²	5.65	5.65	4.70	4.70	5.10	4.25
Sieve adjustment, electric		○	○	○	○	○	○
Returns feed to accelerator		●	●	●	●	●	●
Returns visible from the cab on the go		●	●	●	●	●	●
Grain tank							
Capacity	l	9000	8500	8000	7500	7500	6500
Unloading auger swivel angle	degrees	99	99	99	99	99	99
Discharge rate	l/s	105	105	90	90	90	90
QUANTIMETER yield meter		○	○	○	○	○	○
Chopper							
SPECIAL CUT 80-blade straw chopper		○	○	–	–	○	–
SPECIAL CUT 68-blade straw chopper		–	–	○	○	–	○
STANDARD CUT 60-blade straw chopper		○	○	–	–	○	–
STANDARD CUT 52-blade straw chopper		–	–	○	○	–	○
HD chaff spreader		○	○	○	○	○	○
Straw spreader		○	○	○	○	○	○
ACTIVE SPREADER		○	○	–	–	○	–
Running gear							
4-TRAC		○	○	○	○	○	○
EASY							
CEBIS		●	●	●	●	●	●
TELEMATICS		○	○	○	○	○	○
Job management		○	○	○	○	○	○
Yield mapping		○	○	○	○	○	○
GPS PILOT, LASER PILOT, AUTO PILOT		○	○	○	○	○	○

CLAAS continually develops its products to meet customers' requirements, so all products are subject to change without notice. All descriptions and specifications in this brochure should be considered approximate and may include optional equipment that is not part of the standard specifications. This brochure is designed for worldwide use. Please consult your nearest CLAAS dealer and their price list for local specification details. Some protective panels may have been removed for photographic purposes in order to present the function clearly. To avoid hazards, never remove these protective panels yourself. Please refer to the relevant instructions in the operator's manual in this regard. All technical specifications relating to engines are based on the European emission regulation standards: Stage. Any reference to the Tier standards in this document is intended solely for information purposes and ease of understanding. It does not imply approval for regions in which emissions are regulated by Tier.

● Standard ○ Option □ Available – Not available

TUCANO		450	440	430	420	340	320
Engine							
Manufacturer		Mercedes-Benz	Mercedes-Benz	Mercedes-Benz	Mercedes-Benz	Mercedes-Benz	Mercedes-Benz
Emissions standard Stage IV (Tier 4)							
Model		OM 936 LA	OM 936 LA	OM 936 LA	OM 936 LA	OM 936 LA	OM 936 LA
Cylinders / displacement	no./l	S 6/7.7	S 6/7.7	S 6/7.7	S 6/7.7	S 6/7.7	S 6/7.7
Maximum output (ECE R 120)	kW/hp	230/313	210/286	210/286	180/245	210/286	180/245
Exhaust aftertreatment SCR + EGR		●	●	●	●	●	●
Urea tank, 57 l		●	●	●	●	●	●
Air compressor		○	○	○	○	○	○
Engine control		electronic	electronic	electronic	electronic	electronic	electronic
Fuel tank capacity, 500 l		–	●	●	●	●	●
Fuel tank capacity, 650 l		●	○	○	○	○	○
Weights							
(can vary depending on equipment) without cutterbar, chopper and chaff spreader	kg	12,750	12,750	12,150	12,150	12,050	11,050

TUCANO		450	440	430	420	340	320
Tyres on the drive axle							
Tyre size		External width					
800/65 R 32 MI	m	3.75	3.75	3.49	3.49	3.75	3.49
IF800/70 R 32 MI	m	3.73	3.73	3.47	3.47	–	3.47
800/70 R 32	m	3.73	3.73	3.47	3.47	–	3.47
800/65 R 32	m	3.83	3.83	3.47	3.57	3.83	3.56
30.5 LR 32	m	–	–	3.49	3.49	–	3.49
710/75 R 34	m	3.62	3.62	3.36	3.36	3.62	3.36
IF 680/85 R 32 CFO	m	3.48	3.48	3.21	3.21	3.48	3.21
680/85 R 32	m	3.48	3.48	3.21	3.21	3.48	3.21
650/75 R 32	m	3.47	3.47	3.21	3.21	3.47	3.21
620/75 R 30 F16	m	–	–	2.99	2.99	–	2.99
620/75 R 30 F20	m	–	–	–	–	–	3.23
650/75 R 32 + dual 18.4 R 38	m	4.88	4.88	–	–	–	–
Steel half track for rice 900 mm	m	4.17	4.17	–	–	–	–

TUCANO		450	440	430	420	340	320
Tyres on the steering axle							
Tyre size		External width					
14.5/75-20 IMP	m	–	–	2.95	2.95	–	2.95
16.5/85-24 IMP	m	3.26	3.26	3.11	3.11	3.26	3.11
440/80 R 24 MI	m	3.26	3.26	3.11	3.11	3.26	3.11
500/70 R 24 IMP	m	3.32/ 3.46 ¹	3.32/ 3.46 ¹	3.17/ 3.26 ¹	3.17/ 3.26 ¹	3.32/ 3.46 ¹	3.17/ 3.26 ¹
500/70 R 24 MI	m	3.32	3.32	3.17	3.17	3.32	3.17
500/85 R 24 IMP	m	3.34/ 3.48 ¹	3.34/ 3.48 ¹	3.19/ 3.28 ¹	3.19/ 3.28 ¹	3.34/ 3.48 ¹	3.19/ 3.28 ¹
VF 520/80 R 26	m	3.34/ 3.48 ¹	3.34/ 3.48 ¹	3.19/ 3.28 ¹	3.19/ 3.28 ¹	3.34/ 3.48 ¹	3.19/ 3.28 ¹
600/55-26.5 IMP	m	3.61/ 3.7 ¹	3.61/ 3.7 ¹	–	–	–	–
600/65 R 28 IMP	m	3.7 ¹	3.7 ¹	–	–	–	–
VF620/70 R 26 MI	m	3.7 ¹	3.7 ¹	–	–	–	–

1 All-wheel-drive axle – 4-TRAC

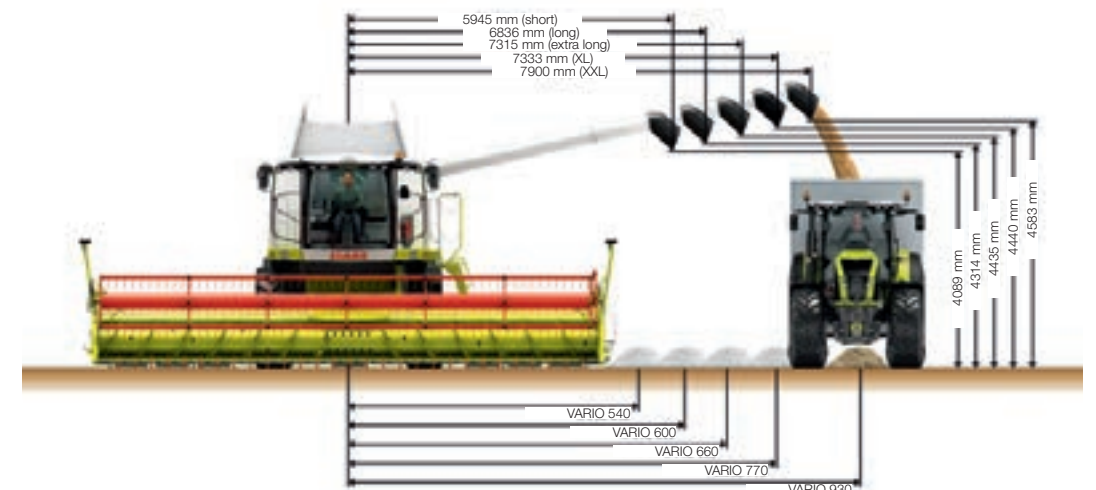

● Standard ○ Option □ Available – Not available

Cutterbars			
Front attachments			
VARIO cutterbars		V 930, V 770, V 660, V 600, V 540	
CERIO cutterbars		CERIO 930, CERIO 770	
Standard cutterbars		C 660, C 600, C 540, C 490, C 430, C 370	
Rapeseed attachments		For all standard and VARIO cutterbars, not available for CERIO cutterbars	
Folding cutterbars		C 540, C 450	
Maize picker	rows	8 (TUCANO 450 440), 6	
SUNSPEED	rows	12 and 8	
FLEX cutterbars		S 900, S 750, S 600, S 510, S 450	
MAXFLO		1050, 900	
Standard rice cutterbars		R 660, R 600, R 540, R 490, R 430	
VARIO rice cutterbars		V 930 and V 770 available as HD versions with rice harvesting accessory pack, V 660, V 600, V 540	
CERIO rice cutterbars		CERIO 930 and 770 available as HD versions with rice harvesting accessory pack	
SWATH UP		SWATH UP 450	
Standard cutterbars			
Effective cutting widths		C 660 (6.68 m), C 600 (6.07 m), C 540 (5.46), C 490 (4.92), C430 (4.32), C 370 (3.71)	CERIO 930 (9.22 m), CERIO 770 (7.70 m)
Drive		Single-side belt drive	Single-side gear drive
Folding dividers		●	●
Spacing: knife bar – intake auger	mm	580	480–680, manually adjustable
Cutting frequency	strokes/min	1120	1218
Multifinger intake auger		●	●
Reverser, hydraulic		●	●
Automated cutterbar control			
CONTOUR		●	●
AUTO CONTOUR		○	○
Reel speed control		●	●
Reel height adjustment		●	●
Parked position		–	●
Replacement knife bar		●	●
Crop lifters		●	●
VARIO cutterbars			
Effective cutting widths		V 930 (9.22 m), V 770 (7.70 m)	V 660 (6.68 m), V 600 (6.07 m), V 540 (5.46 m)
Drive		Single-side gear drive	Single-side belt drive
Folding dividers		●	●
Spacing: knife bar – intake auger	mm	480–1180, 700 mm continuously adjustable travel range	480–780, for rapeseed 1080
Knife bar		Undivided	Undivided
Cutting frequency	strokes/min	1218	1120
Reel and auger bearing		Undivided reel and auger	Undivided reel and auger
Intake auger diameter		660	580
Automated cutterbar control			
CONTOUR		●	●
AUTO CONTOUR		○	○
Reel speed control		●	●
Reel height adjustment		●	●
Reel levelling system		●	●
Table positioning		●	●
Parked position		○	–
Replacement knife bar		●	●
Crop lifters		●	●



CLAAS KGaA mbH
Postfach 1163
33416 Harsewinkel
Deutschland
Tel. +49 (0)52 47 12-0
claas.com

HRC / 114012000714 KK DC 0714 / 00 0256 175 7