

Fuller Mid Range Transmissions TRSM0196

October 2007



Powering Business Worldwide

BACKED BY

Roadranger

SUPPORT

For parts or service call us
Pro Gear & Transmission, Inc.



1 (877) 776-4600

(407) 872-1901

parts@eprogear.com

906 W. Gore St.

Orlando, FL 32805



Caution -

Before towing the vehicle, be sure to lift the rear wheels off the ground or disconnect the driveline to avoid damage to the transmission during towing.

FOREWARD

This manual has been prepared to provide the customer and the maintenance personnel with information and instructions on the maintenance and repair of the CLARK® Transmission.

Extreme care has been exercised in the design, selection of materials and manufacturing of these units. The slight outlay in personal attention and cost required to provide regular and proper lubrication, inspection at stated intervals, and such adjustments as may be indicated will be reimbursed many times in low cost operation and trouble free service.

In order to become familiar with the various parts of the transmission, its principle of operation, troubleshooting and adjustments, it is urged that the service person study the instructions in this manual carefully and use it as a reference when performing maintenance and repair operations.

Whenever repair or replacement of components parts is required, only Clark-approved parts as listed in the applicable parts manual should be used. Use of "will-fit" or non-approved parts may endanger proper operation and performance of the equipment. The Clark Equipment Company does not warrant repair or replacement parts, nor failures resulting from the use thereof, which are not supplied by or approved by the Clark Equipment Company.

IMPORTANT: Always furnish the Distributor with the transmission serial and model number when ordering parts.

The CL455 is our “soft fourth” transmission, with the 28 percent step from fourth to fifth. The soft fourth allows the use of a two speed axle without the confusing swap shift in fourth and fifth speeds.

The CL457 is the conventional short fourth 5-speed, for those that still prefer it.

And the CL450 is a straight 5-speed with an 8 to 1 low and reverse ratio . . . a real benefit when a steep grade must be negotiated.

Speed	MODELS		
	CL455 (Soft 4th)	CL457 (Short 4th)	CL450 (Straight 5-speed)
Fifth	Direct	Direct	Direct
Fourth	1.28	1.17	1.48
Third	2.13	2.13	2.48
Second	3.78	3.78	4.35
First	6.99	6.99	8.05
Reverse	6.99	6.99	8.05

Nomenclature-CL Stands for Clark. 1st number stands for nominal torque capacity (nom. 400/lb./ft.). 2nd number is number of forward speeds. 3rd number denotes specific gear set.

Constant mesh in all gears, including low and reverse, is a CL450 feature as is helical gearing throughout, including low and reverse.

The Clark split-pin synchronizer is used in 2nd, 3rd 4th and 5th gears. Greater bearing capacity in the CL450 is achieved by the use of numerous needle roller bearings, and tapered roller bearings at main support locations.

Shift forks have replaceable bronze inserts. The shift pattern is of the standard progression type with all shifts having the same throw at the lever.

CL 450 SERIES

ASSEMBLY INSTRUCTIONS

Unless otherwise specified:
Tighten all capscrews 20 to 25 lbs. ft. [27,2 - 33,8 N.m].

Use a Grade #2 Multi-Purpose Grease to retain needle rollers in reverse idler gear bore during assembly.

Apply a thin coat of Loctite 510 Gasket Eliminator to the O.D. of all oil seals and countershaft front bore plug before assembly.

Hand-spin idler gear and countershaft assemblies after each is installed on their bearings in trans. case. Both must spin freely and smoothly.

Check all mainshaft constant-mesh gears to make sure they rotate freely on mainshaft.

Fasteners that are removed and reused, apply Loctite 262 Adhesive/Sealant.

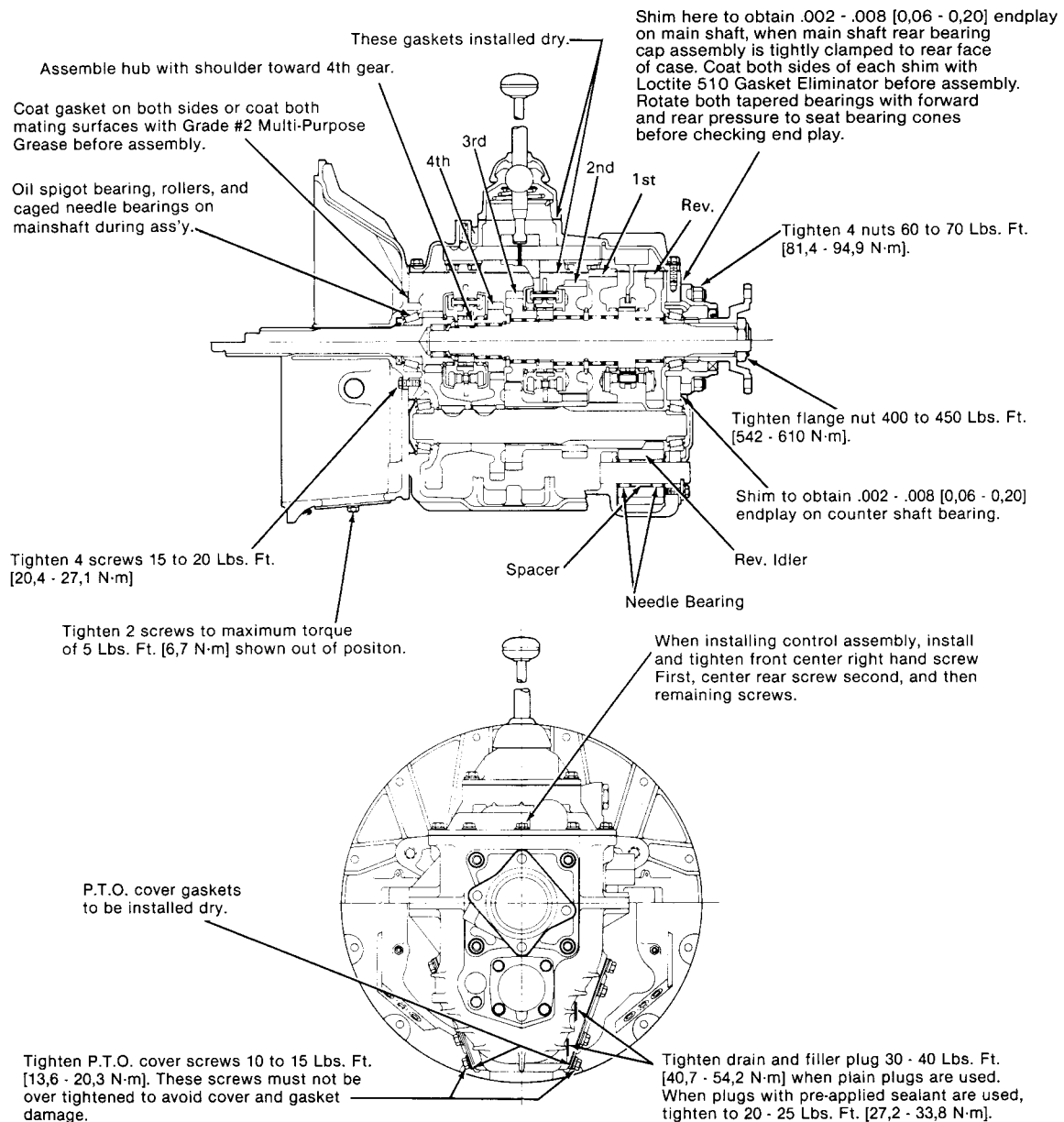

THE CLARK SYNCHRONIZER AND HOW IT WORKS FOR YOU

The Clark split-pin synchronizer prevents the clashing of the gears and increase the speed of shifting.

In a conventional transmission which does not have synchronizers the absence of gear clashing is dependent entirely on the skill of the truck driver. By double-clutching and split second timing of engine speeds with the gear shifting movement, a driver can synchronize the speeds of the engaging gears and thereby prevent the damage to gears by clashing when a fast shift. The splint-pin sychronzier performs the same function with or without the “double-clutching” operating even though the driver does not accurately time his gear shifting movements. It also mechanically prevents the driver from completing the shift to the point of gear engagement until the engaging gears have reached the same or synchronous speeds. This is known as the blocking action of the synchronizer and it is this action that makes the operation of shifting a transmission having synchronizers different from one which does not have synchronizers.

Upon shifting gears in these synchronized transmissions the first part of the gear shift lever movement brings the blockers into contact. The blockers momentarily prevent further movement of the shift lever and the pressure exerted by the driver to complete the movement, is transferred by the blockers to the synchronizer providing the force necessary to synchronize the gears being engaged. When the engaging gears have reached the same speed, the blockers automatically disengage, permitting the gear shift lever movement to be completed. Therefore, to properly shift a synchronized transmission a steady and continuous pressure must be applied by the driver to the shift lever until the shift is completed. Under normal conditions this action is instantaneous.

Sometimes difficulty is experienced in shifting a synchronizer when the vehicle is standing still. This is caused by the fact that the disengagement of the blockers requires relative rotation and with the vehicle at rest and with the engine clutch released, there may be at times, no relative rotation of the engaging gears. Under these conditions, the same continuous pressure should be applied to the shift lever and at the same time, the clutch should be engaged slightly. This will give sufficient rotation to unblock the synchronizer and allow the shift to be completed without difficulty.

RECOMMENDED LUBRICANTS FOR CLARK MANUALLY SHIFTED TRANSMISSIONS

Prevailing Ambient Temperature

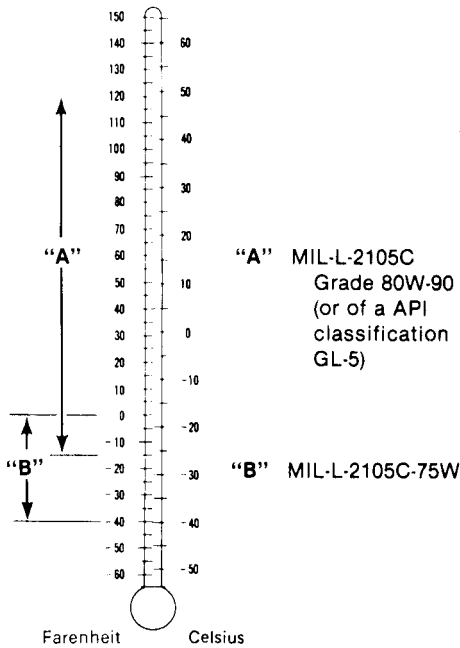

*Mil-L-2105C Extreme Pressure Lubricant (or API classification GL-5) of the SAE viscosity recommended in the chart at the right is preferred. All lubricants should be backed by the reputation of a well-know supplier. It is important to specify EP lubricants of the MIL-L-2105C type only, or of a API classification GL-5.

***Do not use extreme pressure lubricants other than MIL-L-2105C or of a API classification GL-5.**

Many EP lubricants contain highly-active chemical compounds that have been formulated to perform satisfactorily in specific types of applications. Severe corrosion, residual deposits, and inadequate lubrication may result from improper application. Use of EP lubricants other that MIL-L-2105C or of a API classification GL-5 may result in failure and/or impaired operation.

DRAINING ECONOMY - The object in draining the transmission oil periodically is to eliminate possible bearing surface abrasion and attendant wear. Minute particles of metal, the product of normal wear in service, are deposited in and circulate with the transmission oil. The oil changes chemically, due to its repeated heating and cooling, also the terrific churning it undergoes in the presence of air. It is desirable to drain out this used oil after the first 1,000 miles (1609,0 Km) of service (regardless of type of service). Subsequent drains should be made every 24,000 miles (38616,0 Km) or six (6) months (whichever

comes first) for highway service, and every 8,000 to 10,000 miles [12872,0-16090,0 Km] or six (6) months (whichever comes first) "on-off" highway and "pick-up and delivery" types of service. Do this only when the transmission is thoroughly warm.

FLUSHING - After draining, flushing is desirable. Replace the drain plug and fill the transmission to the proper level with a light flushing oil. Drive the transmission for a short period at fast idle in such a manner that the gears in the transmission are rotating without load. This washes out the old oil clinging to the interior of the gear case, covers and shifter rails. **BE SURE TO DRAIN OUT ALL** of the flushing oil before attempting to refill with new oil. This flushing procedure is most important after first drain.

REFILL - First, removal all dirt around the filler plug, Then refill with new oil of a grade recommended for the existing season and prevailing service. Fill to the bottom of the level testing plug positioned on the side of the transmission. **DO NOT OVERFILL**, as the excess quantity will serve no useful purpose. If the oil level is too high, it will cause excessive oil churning and high oil temperature and possible leakage.

INSPECTION - Oil level inspection should be made every 6,000 miles [9654,0 Km] which usually coincides with the vehicle manufacturers chassis lube procedure. Always clean around filler plug before inspection. Add sufficient oil to maintain correct level.

CLARK

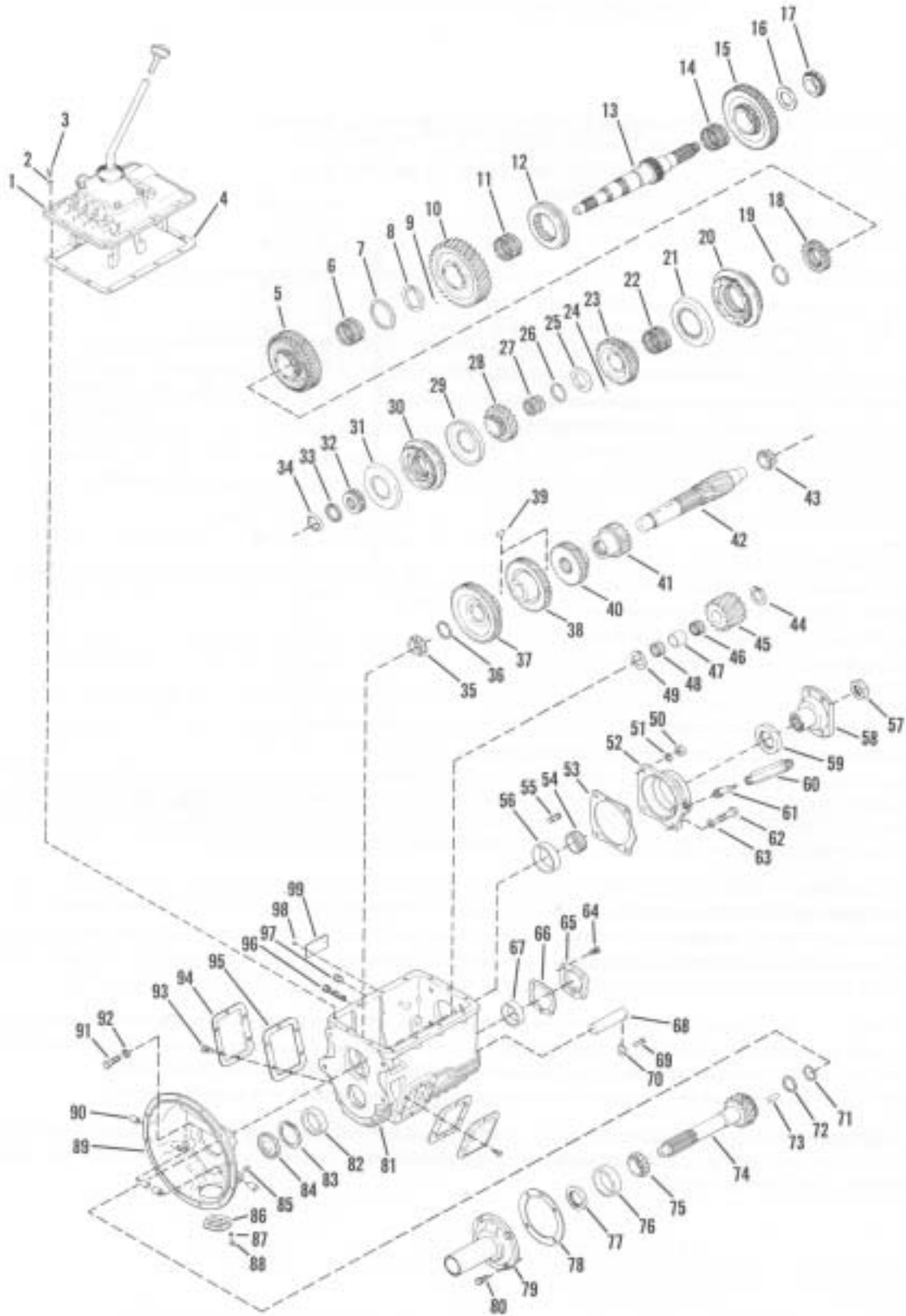

CL450 -SERIES TRANSMISSION

ITEM	DESCRIPTION	QTY.		ITEM	DESCRIPTION	QTY.
1	Control Cover Assembly	1	52	Mainshaft Rear Bearing Cap	1	
2	Control Cover Screw Lockwasher	13	53	Mainshaft Rear Bearing Cap Shim	AR	
3	Control Cover Screw	13	54	Speedometer Driven Gear	1	
4	Control Cover Gasket	1	55	Mainshaft Rear Bearing Cap Stud	4	
5	Mainshaft 2nd Gear	1	56	Mainshaft Rear Bearing Cup	1	
6	Mainshaft 2nd Gear Roller Bearing	1	57	Mainshaft Flange Nut	1	
7	Split Washer Retainer Ring	1	58	Output Flange	1	
8	Mainshaft 2nd Gear Split Washer	2	59	Mainshaft Rear Bearing Cap Oil Seal	1	
9	Split Washer Lock Ball	1	60	Speedometer Drive Gear Tube Nut	1	
10	Mainshaft 1st Gear	1	61	Speedometer Driven Gear	1	
11	Mainshaft 1st Gear Bearing	1	62	Mainshaft Rear Bearing Cap Bolt	4	
12	Mainshaft 1st & Reverse Shift Hub	1	63	Mainshaft Rear Bearing Cap Bolt Washer	4	
13	Mainshaft	1	64	Countershaft Rear Bearing Capscrew	4	
14	Mainshaft Reverse Gear Roller Bearing	1	65	Countershaft Rear Bearing Cap	1	
15	Mainshaft Reverse Gear	1	66	Countershaft Rear Bearing Cap Shim	AR	
16	Mainshaft Rear Bearing Thrust Washer	1	67	Countershaft Rear Bearing Cup	1	
17	Mainshaft Rear Bearing Cone	1	68	Reverse Idler Shaft	1	
18	2nd & 3rd Gear Shift Hub Sleeve	1	69	Reverse Tab Lock Screw	1	
19	2nd Gear Shift Hub Sleeve Retainer Ring	1	70	Reverse Idler Shaft Lock	1	
20	2nd & 3rd Gear Synchronizer Assembly	1	71	Mainshaft Roller Bearing Washer Retainer Ring	1	
21	3rd Gear Synchronizer Cup	1	72	Mainshaft Roller Bearing Washer	1	
22	Mainshaft 3rd Gear Bearing	1	73	Mainshaft Roller Bearing	14	
23	Mainshaft 3rd Gear	1	74	Main Drive Gear	1	
24	Mainshaft 3rd Gear Locating Washer Ball	1	75	Main Drive Gear Bearing Cone	1	
25	Mainshaft 3rd Gear Locating Washer	1	76	Main Drive Gear Bearing Cup	1	
26	3rd Gear Locating Washer Retaining Ring	1	77	Main Drive Gear Bearing Cap Oil Seal	1	
27	Mainshaft 4th Gear Bearing	1	78	Main Drive Gear Bearing Cap Gasket	1	
28	Mainshaft 4th Gear	1	79	Main Drive Gear Bearing Cap	1	
29	4th & 5th Synchronizer Cup	1	80	Main Drive Gear Bearing Capscrews	4	
30	4th & 5th Synchronizer Assembly	1	81	Transmission Case	1	
31	4th & 5th Synchronizer Cup	1	82	Countershaft Front Bearing Cup	1	
32	4th & 5th Shift Hub Sleeve	1	83	Countershaft Front Bearing Race Locator Ring	1	
33	4th & 5th Shift Hub Thrust Bearing	1	84	Countershaft Front Bore Plug	1	
34	4th & 5th Shift Hub Thrust Bearing Race	1	85	Clutch Shaft Grease Fitting	2	
35	Countershaft Front Bearing Cone	1	86	Clutch Housing Cover	1	
36	Countershaft Drive Gear Retainer Ring	1	87	Clutch Housing Cover Screw Lockwasher	2	
37	Countershaft Drive Gear	1	88	Clutch Housing Cover Screw	2	
38	Countershaft 4th Gear	1	89	Clutch Housing	1	
39	Countershaft Gear Key	2	90	Clutch Pedal Shaft Bushing	4	
40	Countershaft 3rd Gear	1				
41	Countershaft 2nd Gear	1	ITEM	DESCRIPTION	QTY.	
42	Countershaft	1	91	Clutch Housing to Case Screw	4	
43	Countershaft Rear Bearing Cone	1	92	Clutch Housing to Case Screw Lockwasher	4	
44	Reverse Idler Gear Thrust Washer	1	93	P.T.O. Cover Lockscrew	12	
45	Reverse Idler Gear	1	94	P.T.O. Cover Plate	2	
			95	P.T.O. Cover Plate Gasket	2	
ITEM	DESCRIPTION	QTY.	96	Magnetic Drain Plug	1	
46	Reverse Idler Gear Bearing	26	97	Filter Plug	1	
47	Reverse Idler Gear Bearing Spacer	1	98	Name Plate Screw	2	
48	Reverse Idler Gear Bearing	26	99	Name Plate	1	
49	Reverse Idler Thrust Washer	1				
50	Mainshaft Rear Bearing Cap Nut	4				
51	Mainshaft Rear Bearing Cap Washer	4				

AR = As Required

CLARK

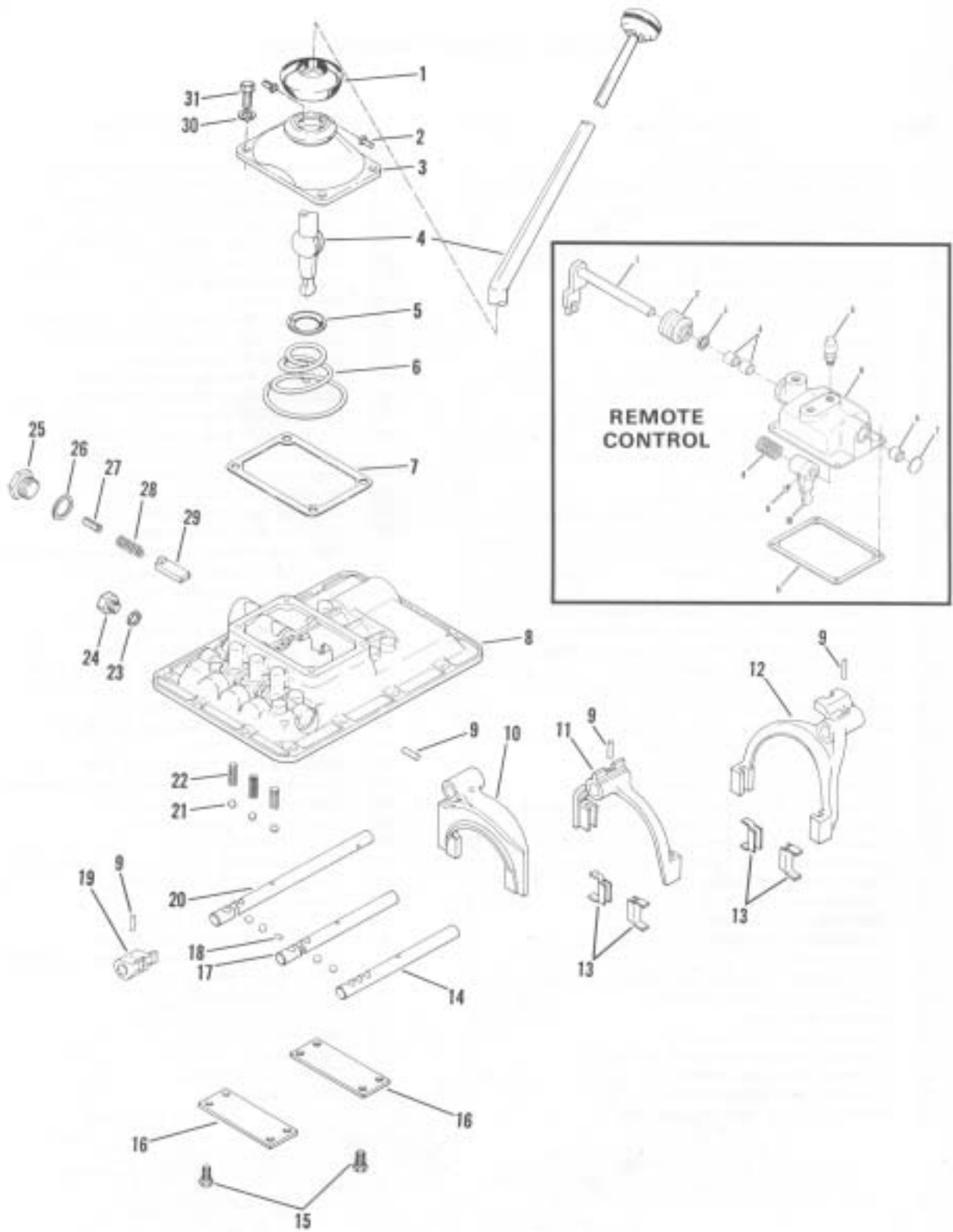

CL450 CONTROL ASSEMBLY (With Round Rails)

ITEM	Description	QTY
1	Gear Shift Lever Dust Cover.....	1
2	Gear Shift Lever Pivot Pin.....	2
3	Control Top.....	1
4	Gear Shift Lever.....	1
5	Gear Shift Lever Support Washer.....	1
6	Support Spring.....	1
7	Control Top Gasket.....	1
8	Shift Rail Housing.....	1
9	Shift Fork Lock Pin.....	4
10	1st & Reverse Shift Fork.....	1
11	2nd & 3rd Shift Fork Assembly.....	1
12	4th & 5th Shift Fork Assembly.....	1
13	Shift Fork Bushing.....	4
14	4th & 5th Shift Rail.....	1
15	Support Screw.....	8
16	Front and Rear Rail Support.....	2
17	2nd & 3rd Shift Rail.....	1
18	Interlock Cross Pin.....	1
19	1st & Reverse Shift Lug.....	1
20	1st & Reverse Shift Rail.....	1
21	Mesh and Interlock Ball.....	7
22	Mesh Lock Spring.....	3
23	Back Up Light Plug Washer.....	1
24	Back Up Light Plug.....	1
25	1st & Reverse Latch Plunger Spring Plug.....	1
26	1st & Reverse Latch Plunger Spring Plug Gasket.....	1
27	1st & Reverse Latch Plunger Stop.....	1
28	1st & Reverse Latch Plunger Spring.....	1
29	1st & Reverse Latch Plunger.....	1
30	Control Top Capscrew Washer.....	4
31	Control Top Capscrew.....	4

Remote Control Assembly *

1. Shaft and lever assembly
2. Boot
3. Oil Seal
4. Bushing
5. Breather
6. Housing
7. Plug
8. Spring
9. Set screw
10. Shift finger
11. Gasket

*Right-hand remote is pictured. Left-hand remote uses identical components, but all are installed on reverse side of control housing, with exception of 8, 9 and 10, which remain the same.

CLARK

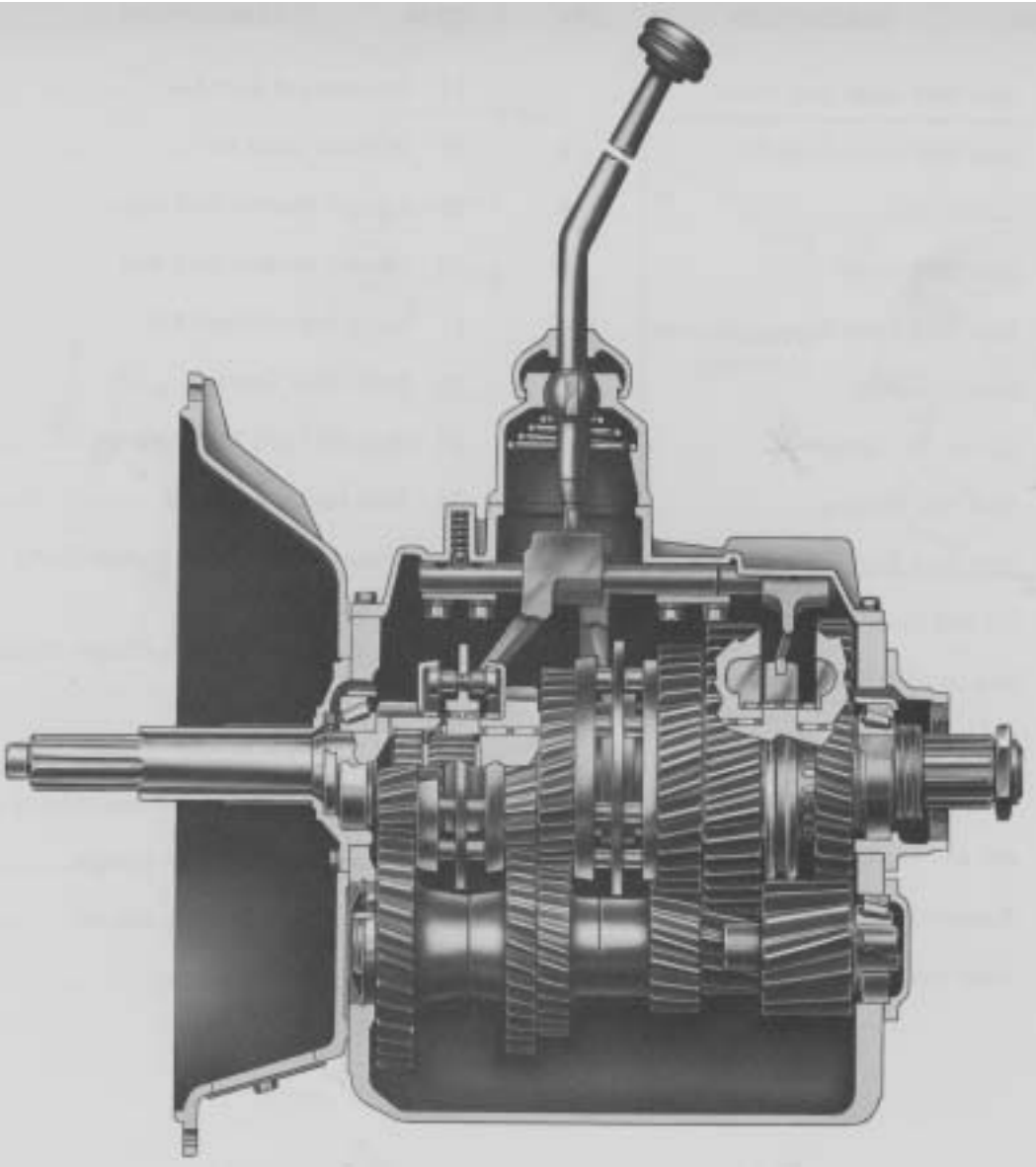

OVERHAUL OF TRANSMISSION ASSEMBLY

The instructions contained herein cover the disassembly and reassembly of the transmission in a sequence that would normally be followed after the unit has been removed from the machine and is to be completely overhauled.

CAUTION: Cleanliness is of extreme importance and an absolute must in the repair and overhaul of this unit. Before attempting any repairs, the exterior of the unit must be thoroughly cleaned to prevent the possibility of dirt and foreign matter entering the mechanism

DISASSEMBLY OF THE TRANSMISSION:

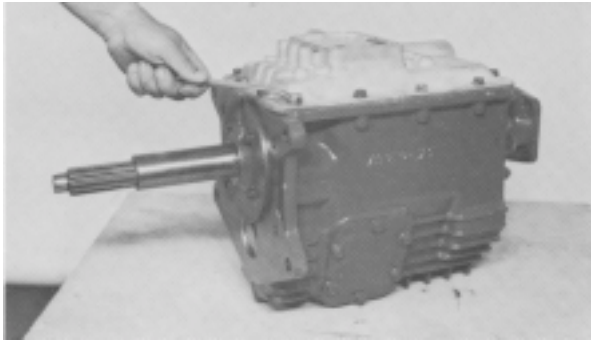

Figure 1 - Remove shift lever control top or remote control assembly. Remove control cover capscrews.

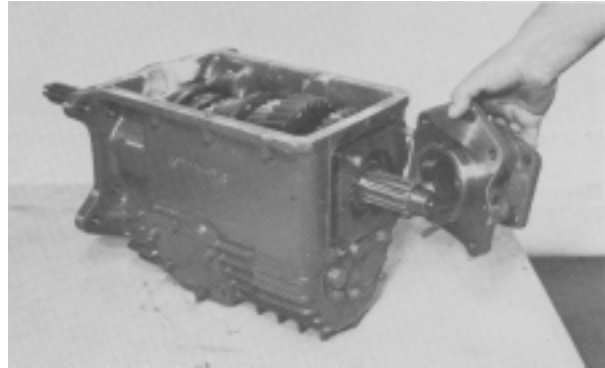

Figure 4 - Remove bearing cap and shims.



Figure 2 - Remove control cover assembly.

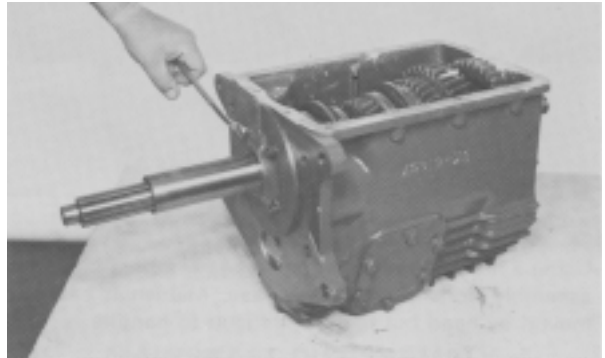

Figure 5 - Remove main drive gear bearing cap bolts.

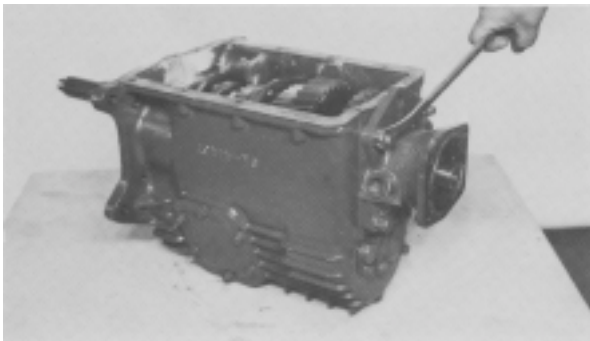

Figure 3 - Remove rear mainshaft bearing cap bolts

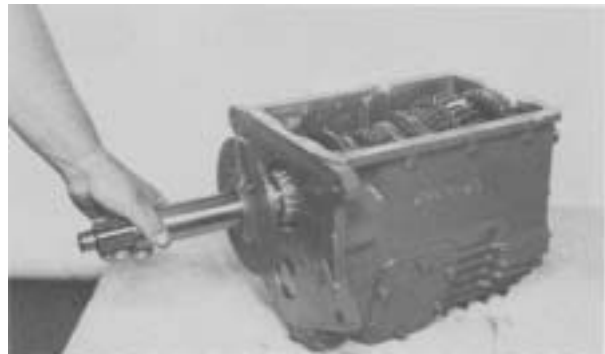

Figure 6 - Remove bearing cap.



Figure 7 - Remove main drive gear and bearing assembly.

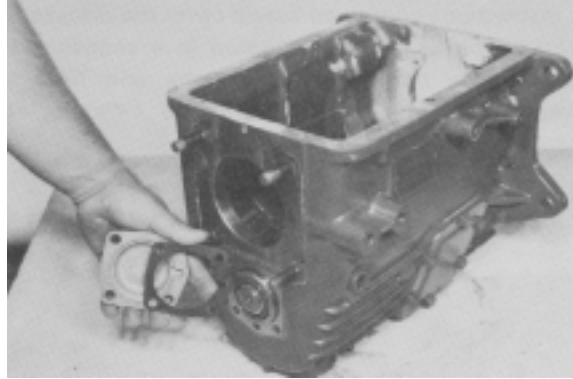

Figure 10 -Remove bearing cap and shims.

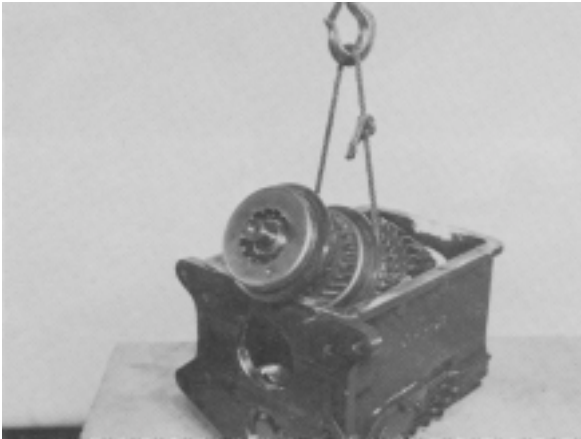

Figure 8 - Using a hoist (if available) and a heavy rope, lift mainshaft assembly from transmission case. Mainshaft can be removed by hand, but is quite difficult to handle.

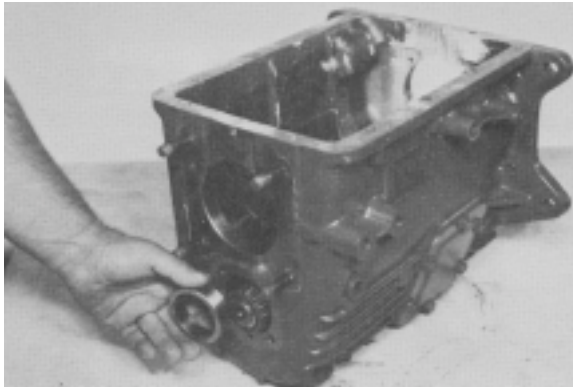

Figure 11 - Remove countershaft rear taper bearing cup.



Figure 9 -Remove countershaft bearing cap bolts.



Figure 12 - Remove countershaft assembly.

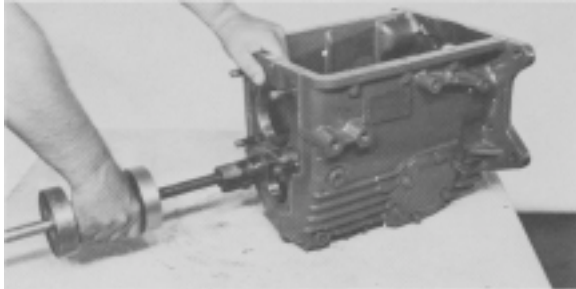

Figure 13 - Using a suitable puller, remove reverse idler shaft.

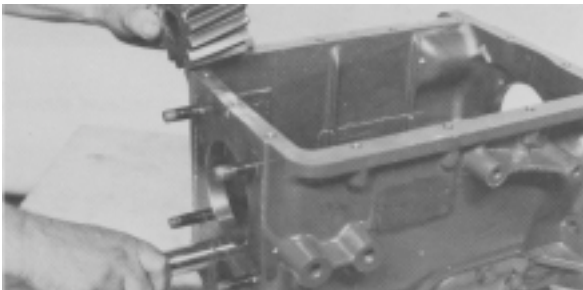

Figure 14 - Remove reverse idler gear and thrust washers. **NOTE:** Idler gear has loose needle rollers in it. DO NOT lose these rollers.

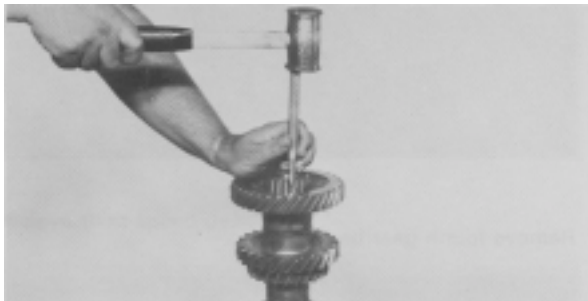

Figure 15 - If the countershaft is to be disassembled for any reason, the front bearing must be destroyed. Split the front bearing cage. Remove cage and taper rollers.

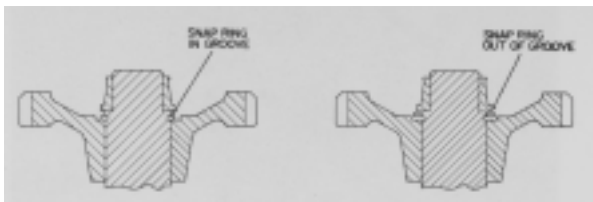

Figure A

Figure B

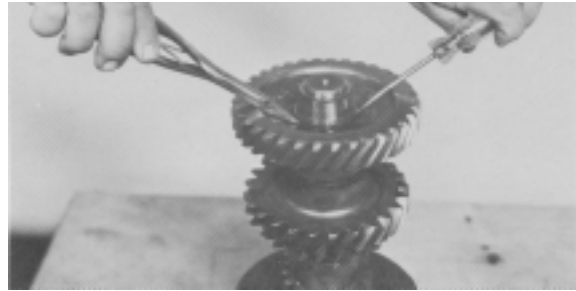

Figure 16 - Using snap ring pliers and screwdriver, remove drive gear retaining ring from ring groove. **NOTE:** Be sure snap ring is completely out of snap ring groove. (See illustration A and B)



Figure 17 - With drive gear, snap ring out of groove, press countershaft drive gear and front taper bearing inner race from shaft. Press 4th gear from shaft. Remove gear keys from countershaft. 3rd speed and 2nd speed gears are splined on the countershaft and may be pressed from shaft, if replacement is necessary.

MAINSHAFT DISASSEMBLY

Position mainshaft assembly in a suitable stand. A vise may be used, if soft jaws are utilized.



Figure 18 - Remove 5th-Speed synchronizer cup.



Figure 19 - Remove shift hub thrust bearing and bearing race.



Figure 22 - Remove 4th speed gear.



Figure 20 - Remove 4th & 5th speed synchronizer assembly/



Figure 23 - Remove 4th gear bearing.



Figure 21 - Remove the 4th & 5th shift hub sleeve.



Figure 24 - Remove 3rd gear locating washer retaining ring.



Figure 25 - Remove washer and lock ball.

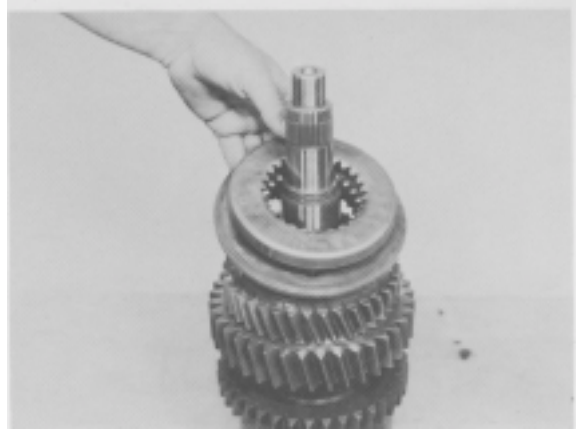

Figure 28 - Remove 2nd & 3rd speed synchronizer.



Figure 26 - Remove 3rd speed gear.

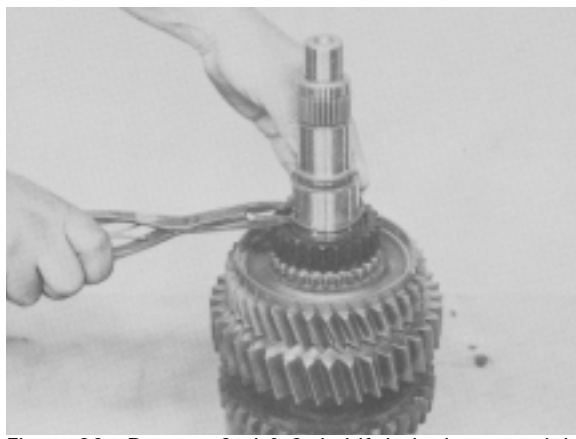

Figure 29 - Remove 2nd & 3rd shift hub sleeve retaining ring.

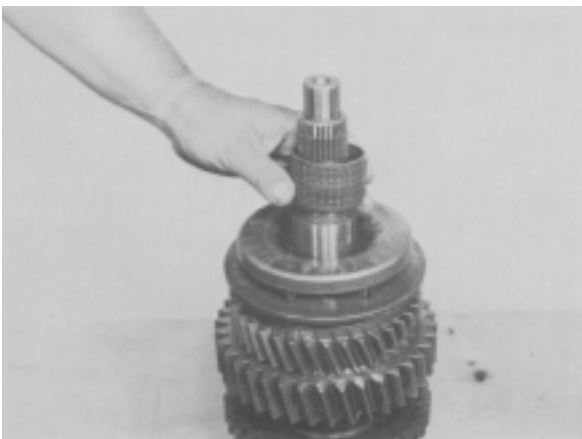

Figure 27 - Remove 3rd gear bearing.

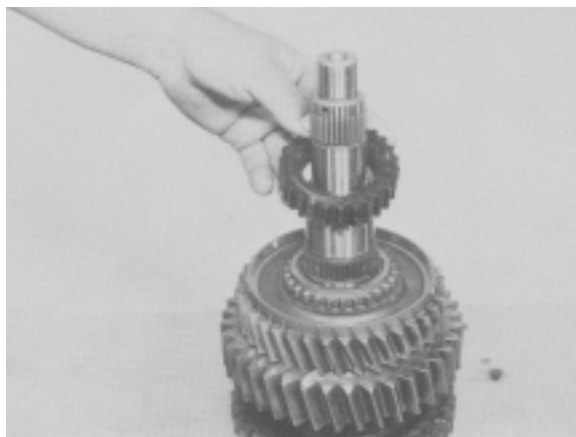

Figure 30 - Remove 2nd & 3rd shift hub sleeve.

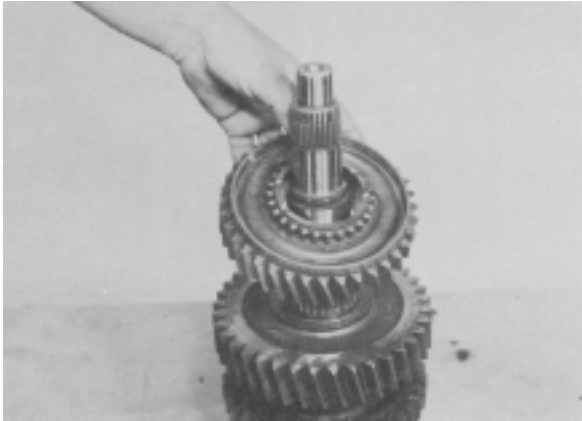

Figure 31 - Remove 2nd speed gear and bearing.

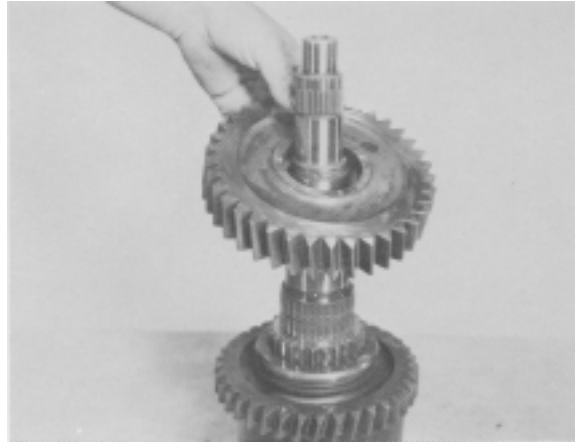

Figure 34 - Remove 1st gear.

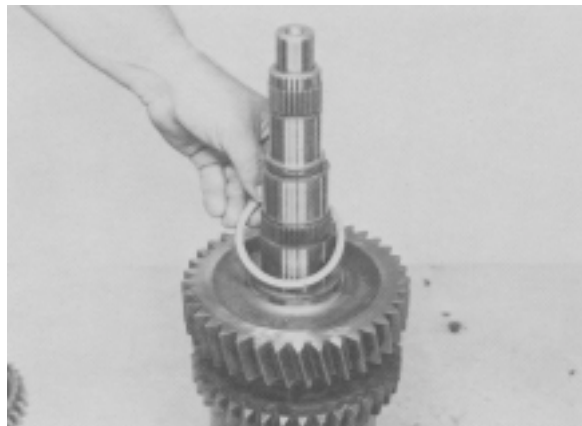

Figure 32 - Remove split ring retainer ring.

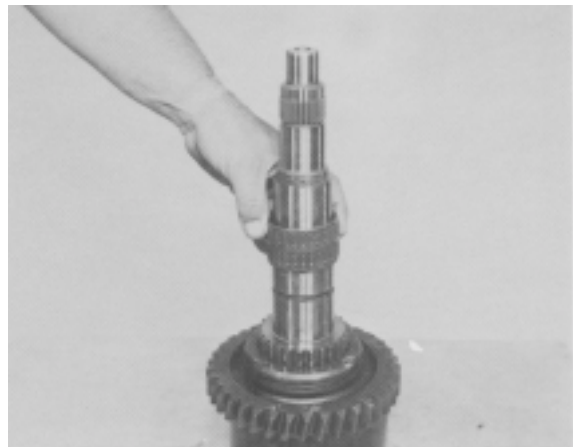

Figure 35 - Remove first gear bearing.

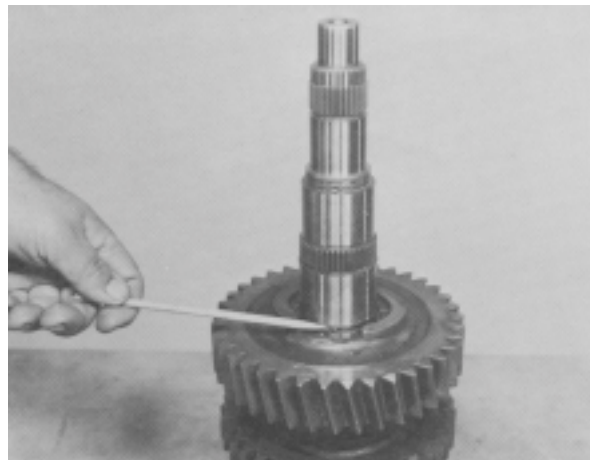

Figure 33 - Separate split ring from groove in mainshaft. Remove split ring halves and lock ball.

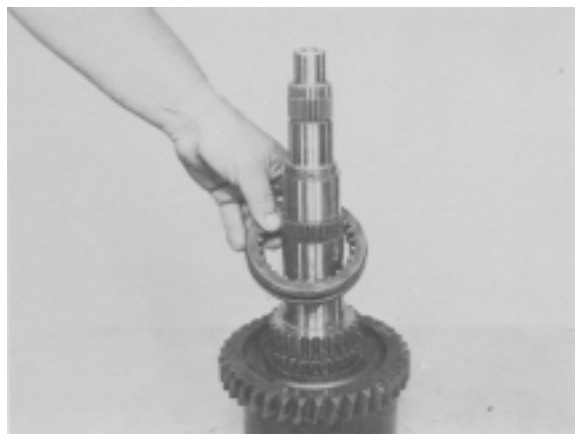

Figure 36 - Remove mainshaft 1st & Reverse shift hub.



Figure 37 - Remove Reverse speed gear and rear bearing from mainshaft.

See Cleaning and Inspection Section on Page 20.

MAINSHAFT ASSEMBLY

NOTE: All parts must be lubricated with Clark recommended transmission lubricant when reassembling. No part should be reassembled dry.

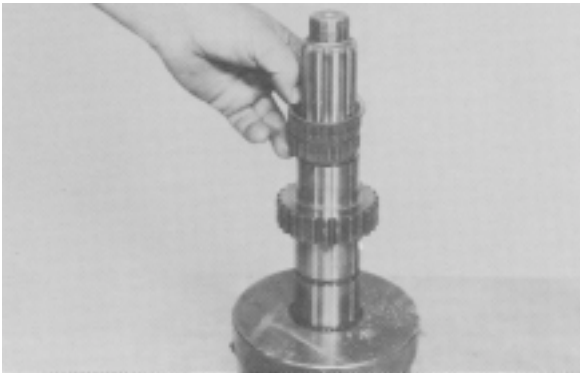

Figure 38 - Position the mainshaft in a suitable stand with the threaded end up. Install the Reverse speed gear roller bearing on shaft.

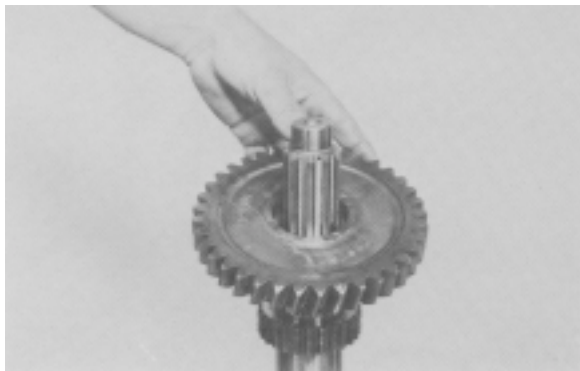

Figure 39 - Position Reverse speed gear on bearing with clutching teeth down

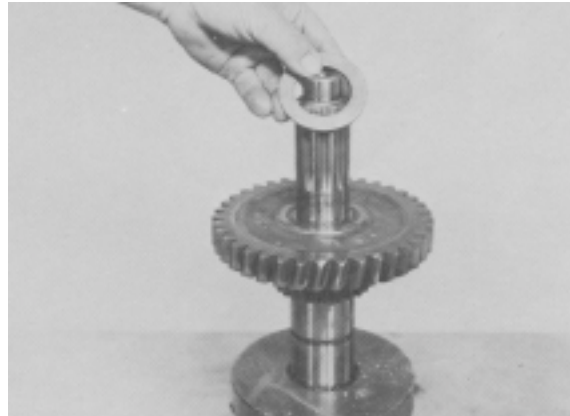

Figure 40 - Install mainshaft rear bearing thrust washer.

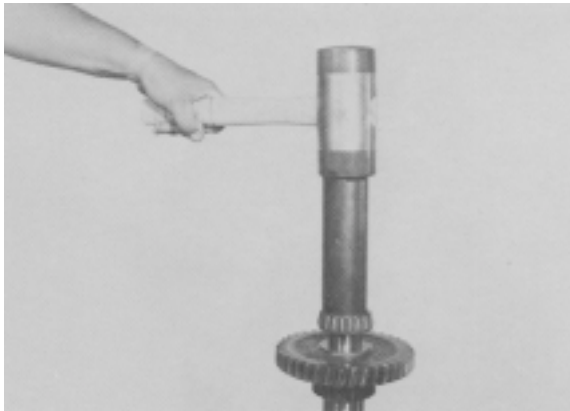

Figure 41 - Using a suitable bearing driver and a soft hammer, install mainshaft rear taper bearing. Be certain bearing race is tight against the thrust washer.

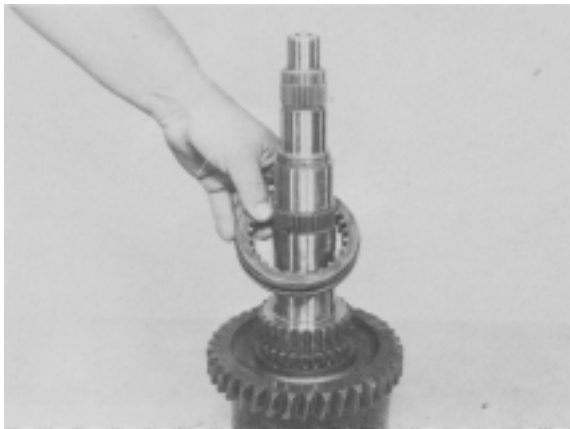

Figure 42 - Turn mainshaft over. Locate 1st & Reverse shift hub on shaft.

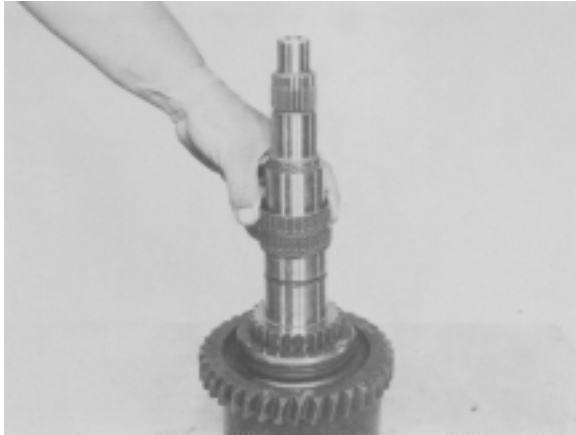

Figure 43 - Install 1st gear roller bearing on shaft.

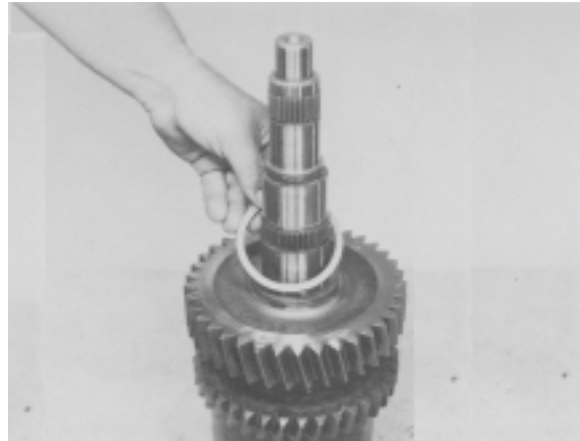

Figure 46 - Position split washer retainer ring over split washer.

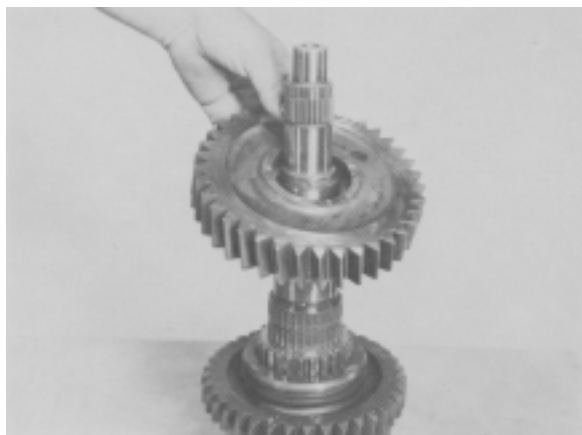

Figure 44 - Position 1st gear on bearing with clutching teeth down.

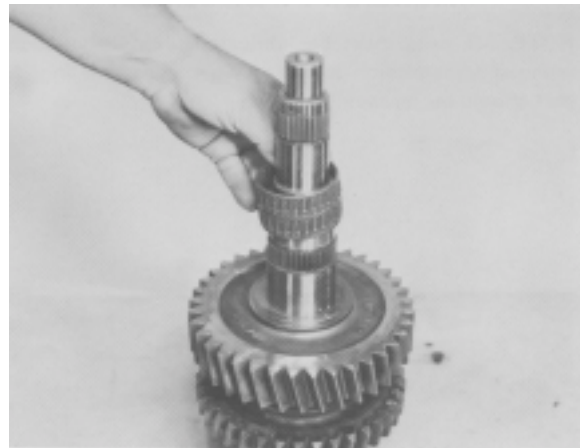

Figure 47 - Install 2nd gear roller bearing on shaft.

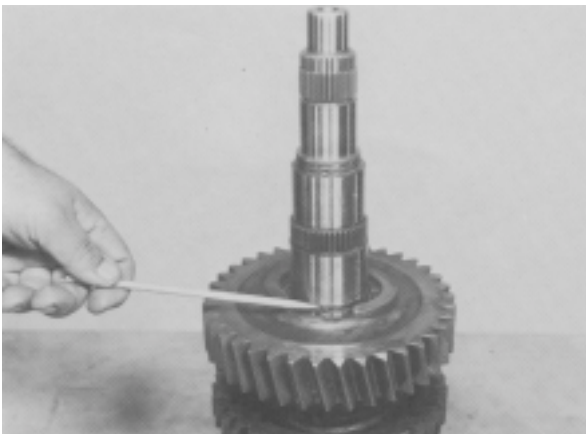

Figure 45 -Position 1st gear split washer locating ball in shaft. Install split washer in washer groove with ends of washer together at locating ball.

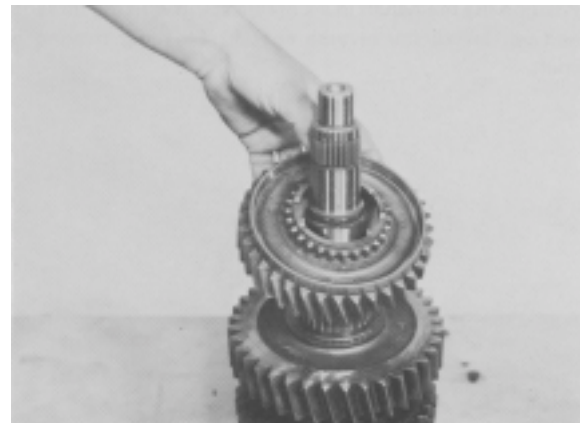

Figure 48 - Position 2nd speed gear on bearing with clutching teeth up.

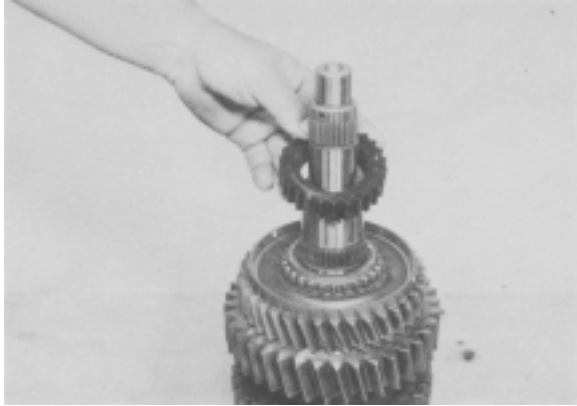

Figure 49 - Install 2nd & 3rd speed shift hub sleeve.
NOTE: Counter bore in sleeve must go up or sleeve retaining ring will not fit in ring groove.



Figure 52 - Install 3rd speed gear roller bearing.

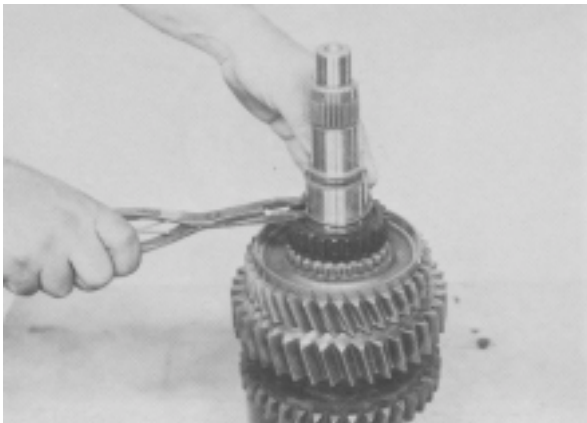

Figure 50 - Install shift hub sleeve retaining ring.



Figure 53 - Position 3rd gear on bearing with clutching teeth down.

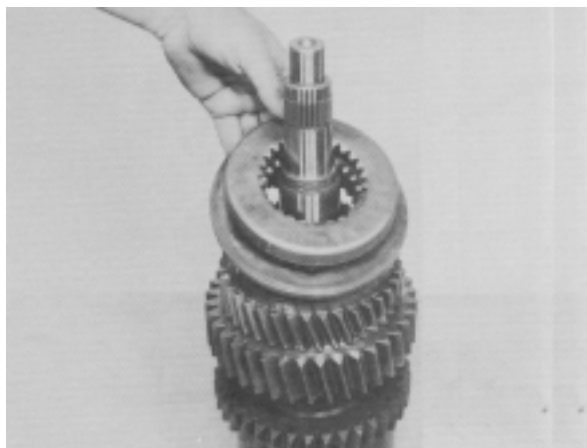

Figure 51 - Install 2nd & 3rd speed synchronizer assembly and 3rd speed synchronizer cup.



Figure 54 - Position 3rd gear locating washer lock ball in mainshaft. Install locating washer on shaft with notch in washer on lock ball.

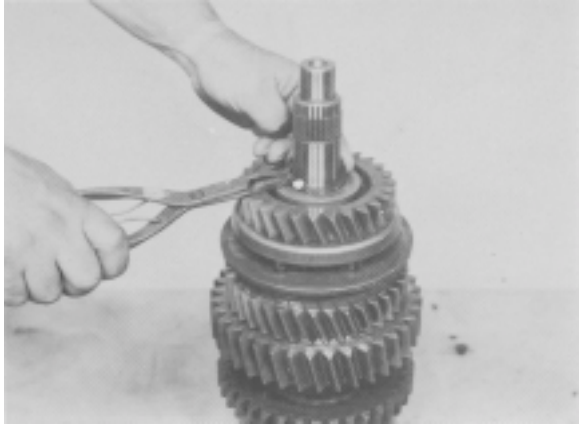

Figure 55 - Install locating washer retaining ring.



Figure 58 - Install 4th & 5th shift hub sleeve. **NOTE:** machine ground surface must be up.

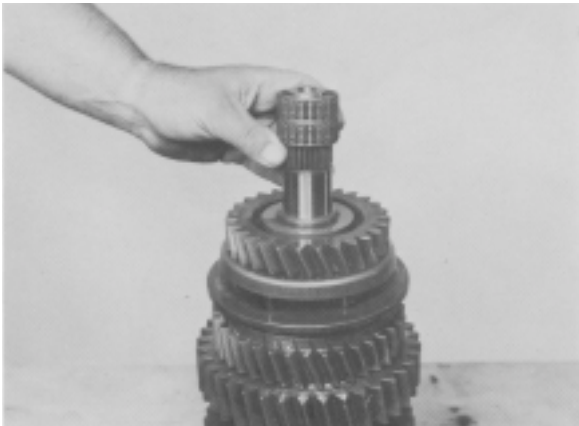

Figure 56 - Install 4th speed gear roller bearing.



Figure 59 - Position 4th speed synchronizer cup and 4th & 5th synchronizer on shift hub sleeve.



Figure 57 -Position 4th gear on bearing with clutching teeth up.



Figure 60 - Position shift hub thrust bearing and thrust bearing race on mainshaft.

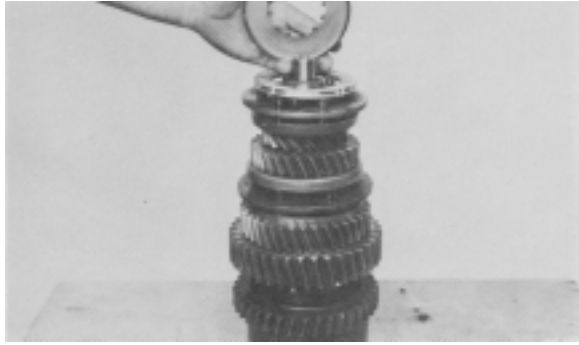

Figure 61 - Install 5th speed synchronizer cup on the synchronizer assembly.

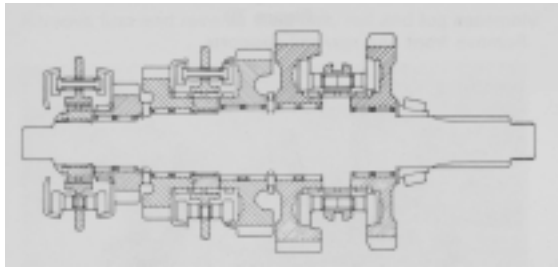

Figure 61-A

COUNTERSHAFT REASSEMBLY

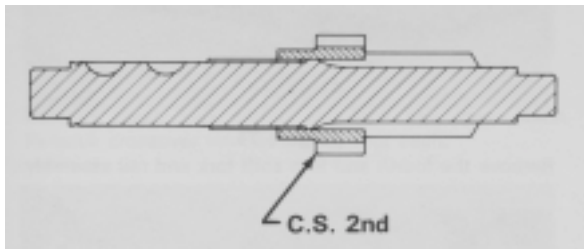

Figure 62 - Press 2nd speed gear on countershaft with hub of gear as shown.

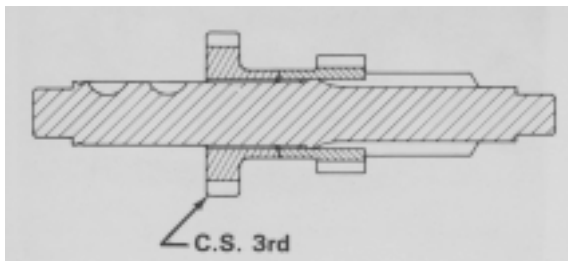

Figure 63 - Press 3rd speed gear on countershaft with hub of gear as shown.

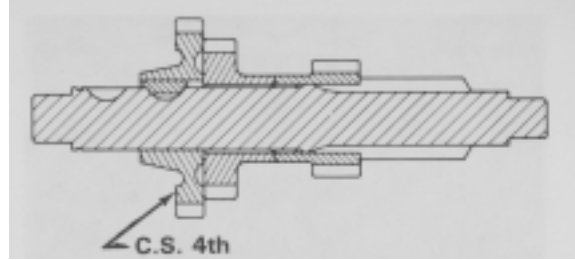

Figure 64 - Install 4th speed gear key in countershaft key slot. With hub of gear as shown, align 4th gear keyway with key in countershaft. Press gear on shaft.

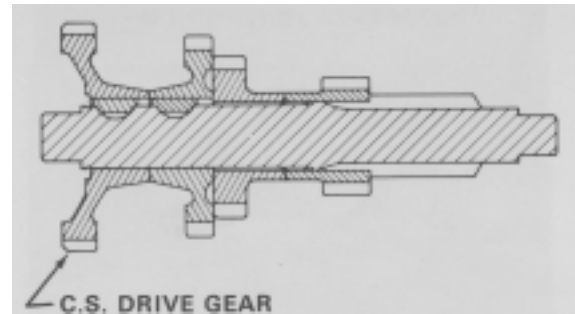

Figure 65 - Install drive gear key in countershaft key slot. With hub of gear as shown, align drive gear keyway with key in countershaft. Press gear on shaft.



Figure 66 - Install drive gear retaining ring. NOTE: Make sure retaining ring is in full position in ring groove.

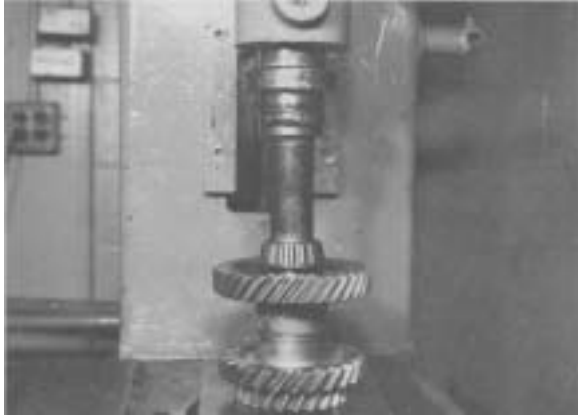

Figure 67 - Install countershaft front and rear taper bearings.

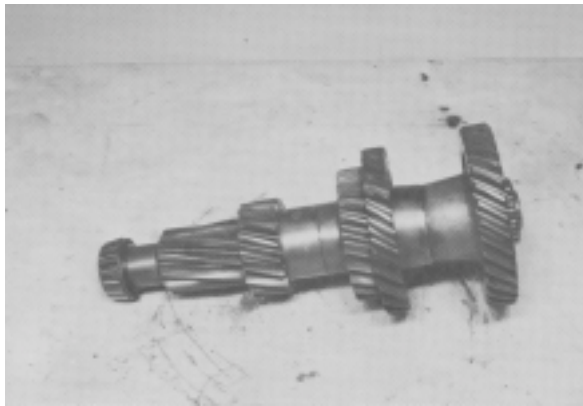

Figure 68 - Overall view of countershaft assembly.

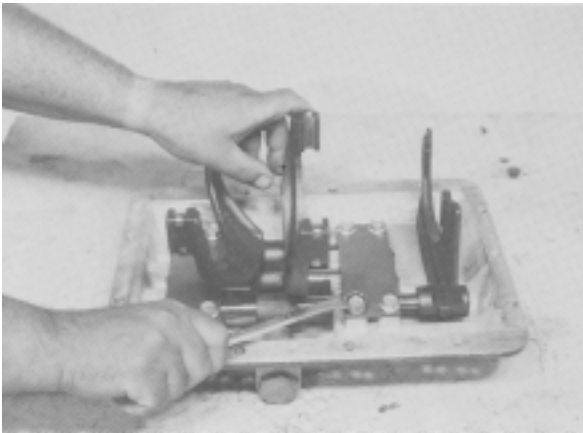

Figure 69 - Remove front and rear rail support cap screws.

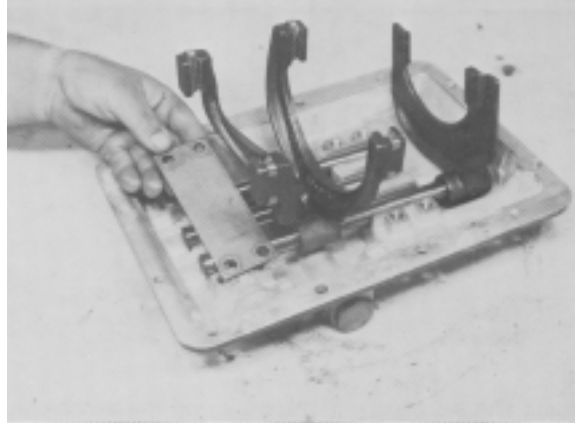

Figure 70 - Remove front and rear rail supports.

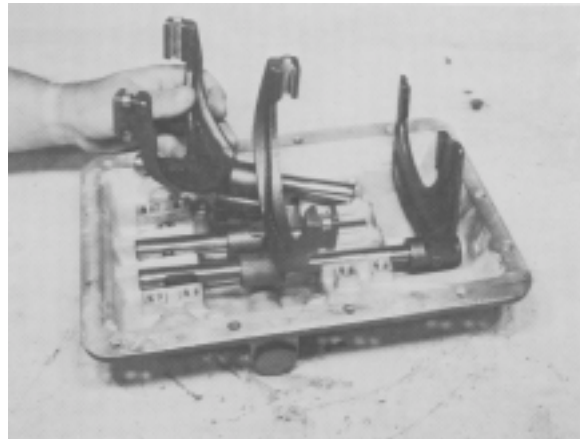

Figure 71 - Remove the 4th & 5th shift fork and rail assembly.

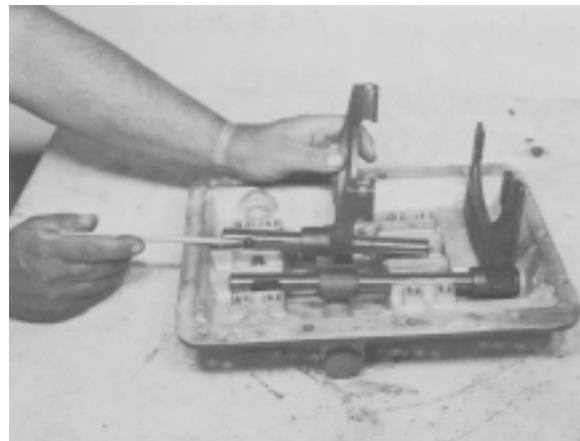

Figure 72 - Remove 2nd & 3rd shift fork and rail assembly. CAUTION: Do not lose interlock cross pin.

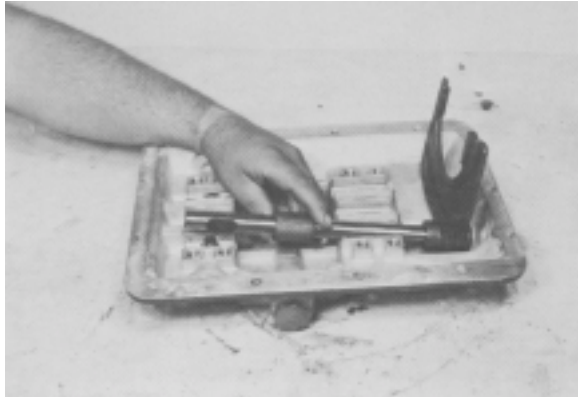

Figure 73 - Remove 1st & Reverse shift fork, rail and lug assembly.

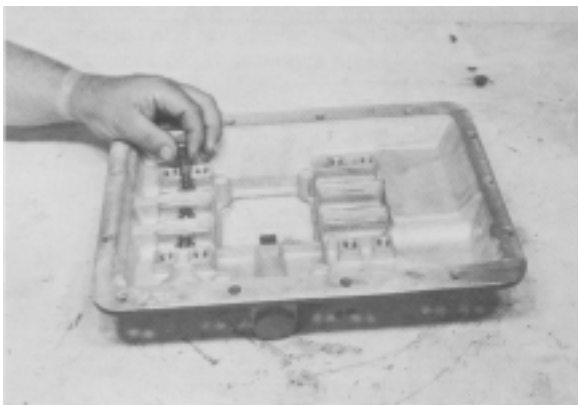

Figure 74 - Remove mesh lock spring and lock ball, 3 each. Remove crossover interlock balls, 4 each.

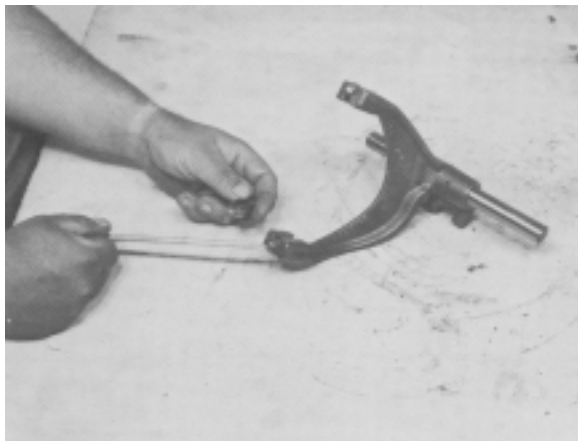

Figure 75 - If the 2nd, 3rd, 4th or 5th shift fork bushing is to be replaced, remove worn bushings from fork. Install new bushing and bend bushing tab over top and bottom of fork.

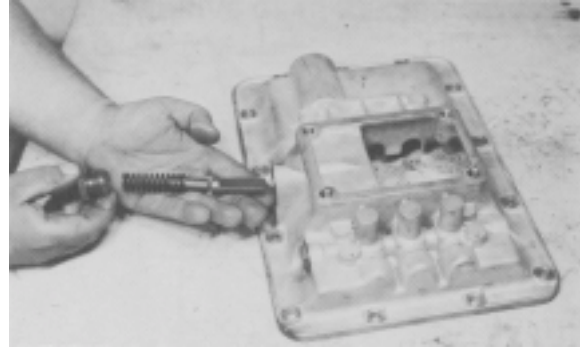

Figure 76 - Remove Reverse latch plunger, pin and spring.

See Cleaning and Inspection Section Page 20.

SHIFT CONTROL REASSEMBLY

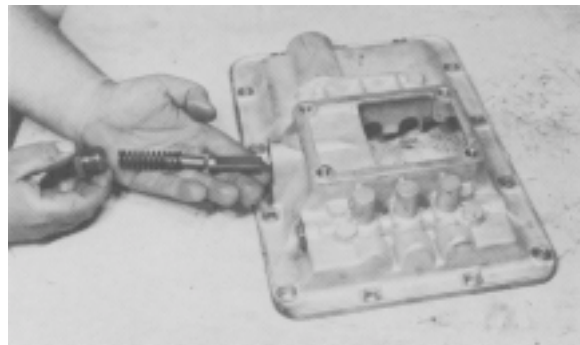

Figure 77 - Install Reverse latch plunger, spring, pin and plunger spring plug.

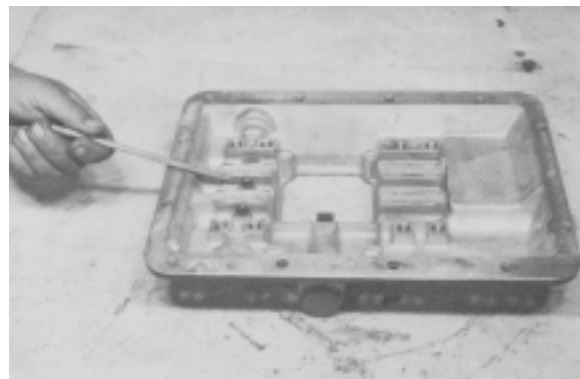

Figure 78 - Position crossover interlock balls in cover cross bores. 2 balls in cover cross between 1st & Reverse rail groove, and 2nd & 3rd rail groove and 2 balls in cover cross bore between 2nd & 3rd rail groove, and 4th & 5th rail groove. (See cross section Figure 78-A)

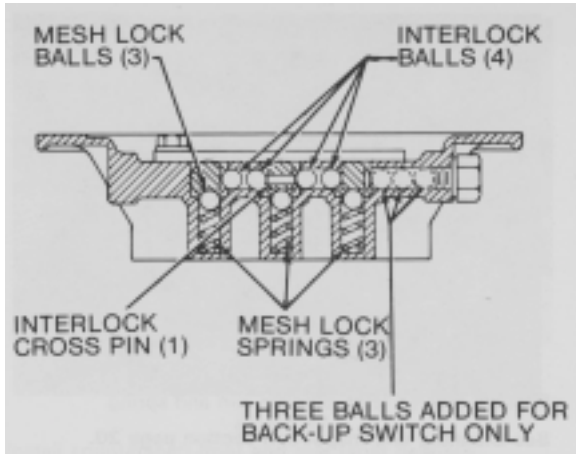

Figure 78-A



Figure 81 - Install interlock cross pin in 2nd & 3rd shift rail. Position 2nd & 3rd shift rail and fork assembly in rail groove over mesh lock ball and spring. Make certain cross pin is in position in rail. (See Figure 78-A).

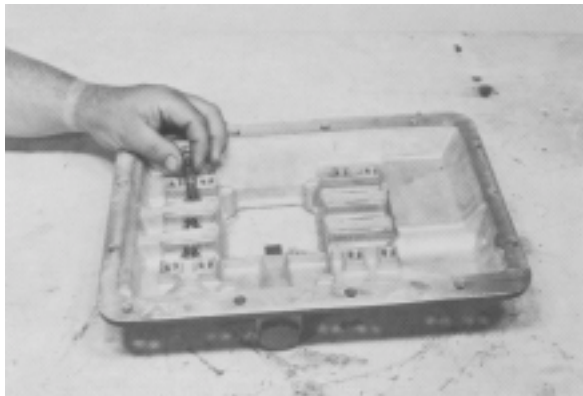

Figure 79 - Position the mesh lock spring and ball, 3 each, in spring pockets. (See cross section Figure 78-A).

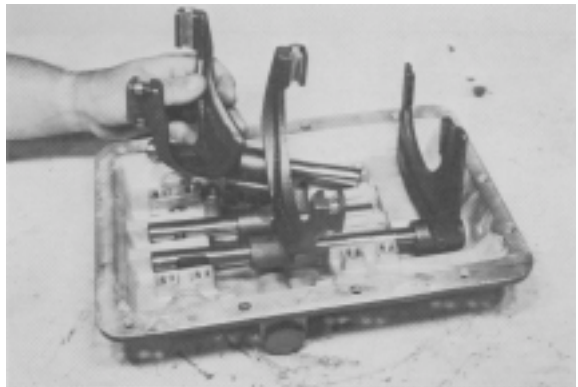

Figure 82 - Position the 4th & 5th shift rail and fork assembly in rail groove over mesh lock ball and spring.

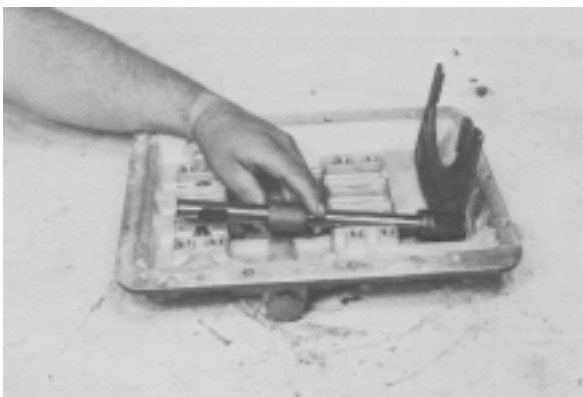

Figure 80 - Position the 1st & Reverse shift fork, rail and lug assembly in rail groove over mesh lock ball and spring.

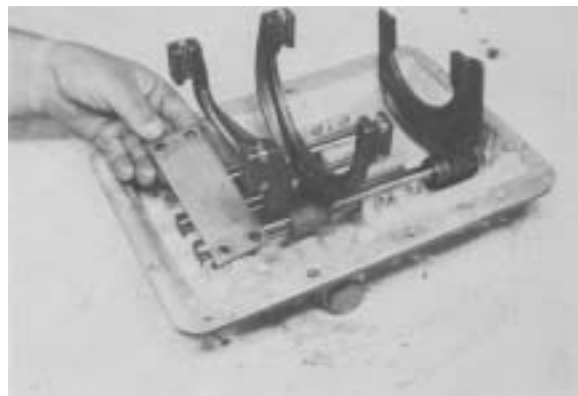

Figure 83 - Position front rail support over shift rails and install cap screws. Position rear support over rails and install cap screws.

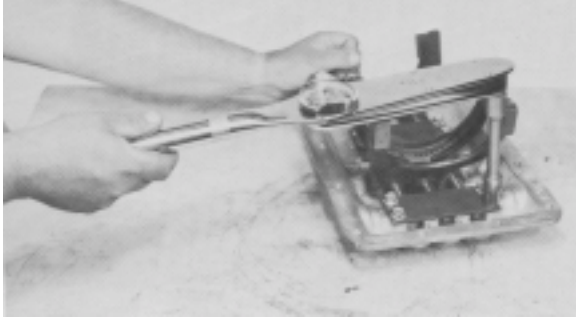

Figure 84 - Tighten support capscrews 20 to 25 ft. lbs. torque.

Test cover for double shift.

Pry 4th & 5th shift fork and rail out of neutral position. Try to pry 1st & Reverse shift fork and rail out of neutral position. 1st & Reverse fork should NOT shift, if it does, interlock cross pin or interlock cross over balls were NOT assembled correctly. Disassemble cover and correct cross over. (See Figure 78-A).

MAIN DRIVE GEAR DISASSEMBLY

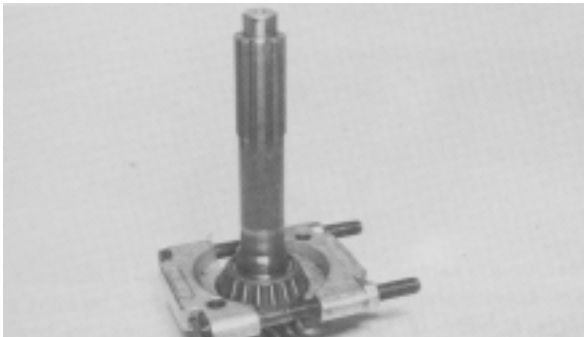

Figure 85 - If main drive gear taper bearing is to be removed, a split puller, as shown, is recommended.

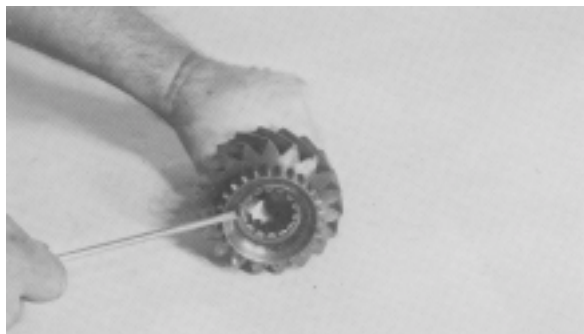

Figure 86 - Remove pilot bearing washer retainer ring. Remove bearing washer. Use caution as not to lose roller bearings.

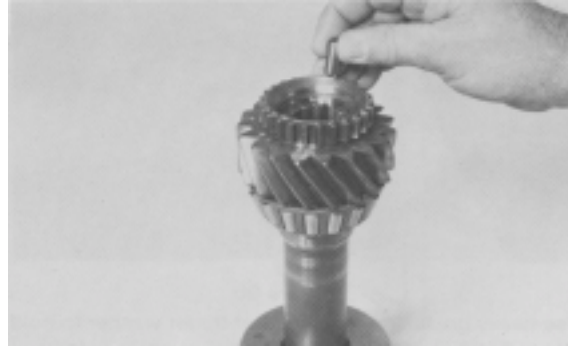

Figure 87 - Press new taper bearing on drive gear. Turn gear over. Using a high quality heavy grease, coat roller bearing surface. Place rollers in grease as shown.

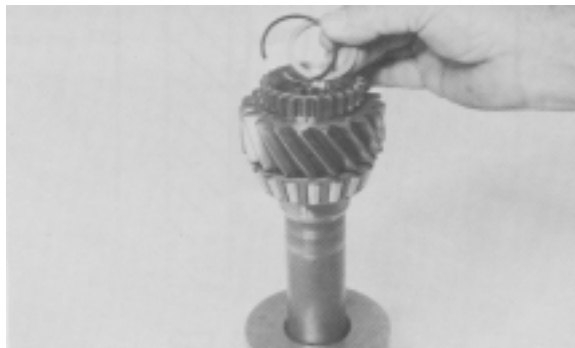

Figure 88 - Install roller bearing washer and retainer ring.

REASSEMBLY OF TRANSMISSION



Figure 89 - If the transmission case or countershaft front taper bearing cup was replaced, install bearing cup locating ring. From inside of case, install bearing cup. Coat outer diameter of bore plug with Loctite 510 and install bore plug in case.

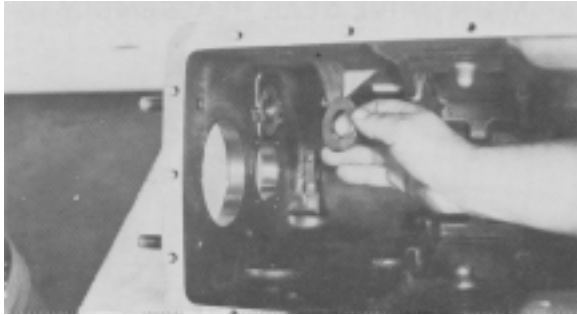

Figure 90 - Use heavy grease on reverse idler thrust washer to hold in place. Position tang of washers in groove in housing.

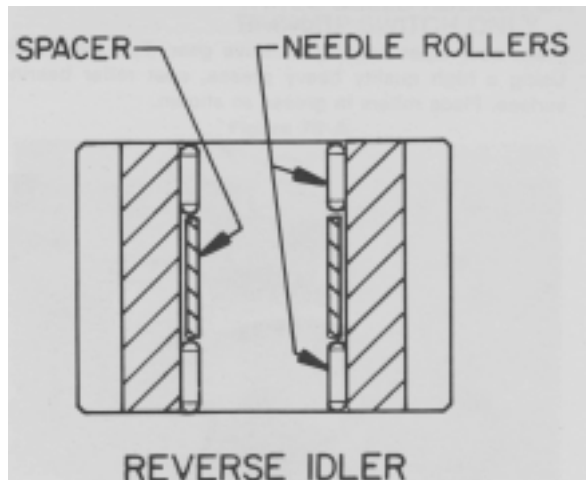

Figure 91 - Coat inside diameter of reverse idler gear with a high quality heavy grease. This will hold needle rollers in position while assembling. (See illustration for position of rollers and spacer).

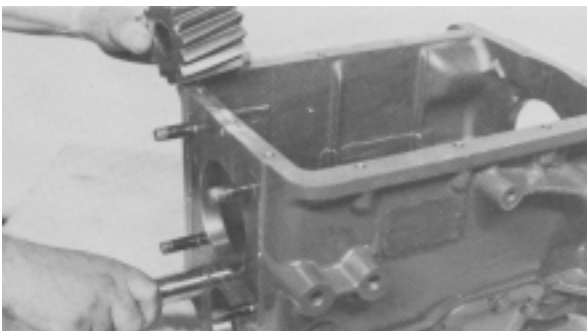

Figure 92 - Carefully position reverse idler gear in housing. Use caution as not to disrupt needle rollers. Insert idler shaft through case and idler gear needle rollers. **NOTE:** Idler shaft lock groove **MUST** line up with lock-screw hole. Drive shaft into position. Install shaft lock and capscrew.

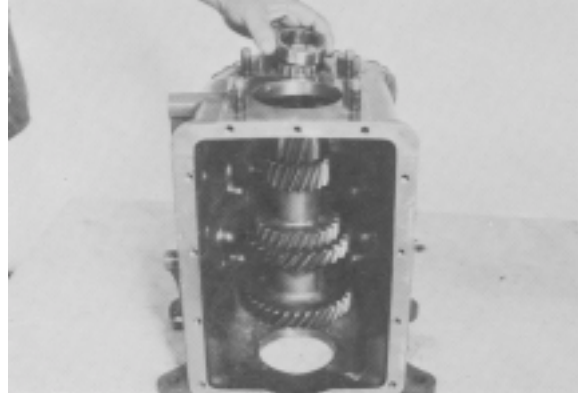

Figure 93 - Turn transmission case on end as shown. Position countershaft assembly into front bearing cup. Install rear bearing cup over rear taper bearing, tap cup into place.

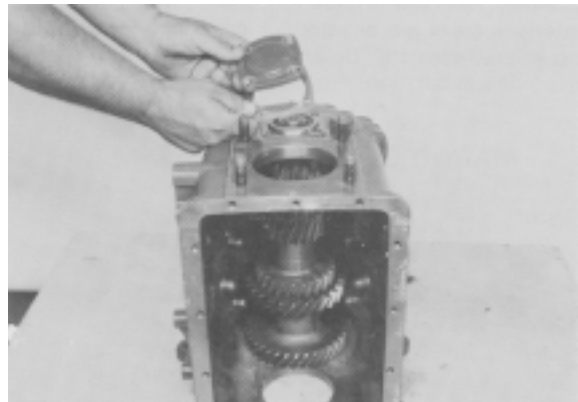

Figure 94 - Position the same shims that were removed at disassembly over countershaft rear bearing cup. Install bearing cap. Apply a band of Loctite 262 Thread Lock to bearing capscrews .125 from end of thread .375 long. (Do not dip capscrews).

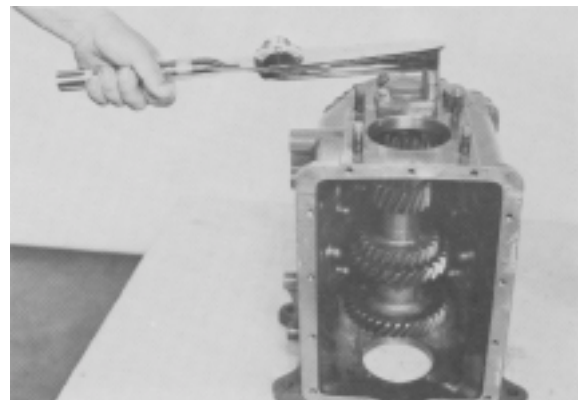

Figure 95 - Tighten capscrews 20-25 Ft. Lbs. Torque.

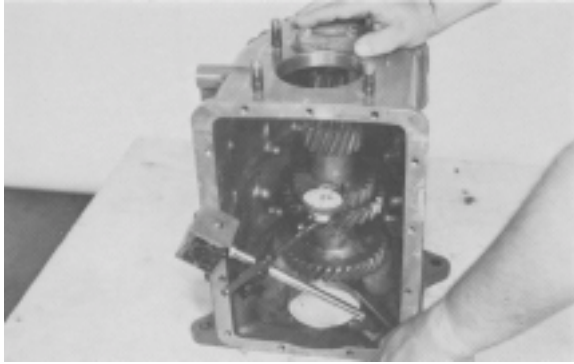

Figure 96 - Roll countershaft to be certain bearings and bearing cups are seated. Position a dial indicator as shown. Pry countershaft to get countershaft end play. End play must be between .002-.008 [0,05 -0,20mm]. Add shims for more end play or remove shims for less end play. NOTE: Each time a change is made, retorque capscrews and roll countershaft. At final assembly, coat both sides of each shim with Loctite 510.

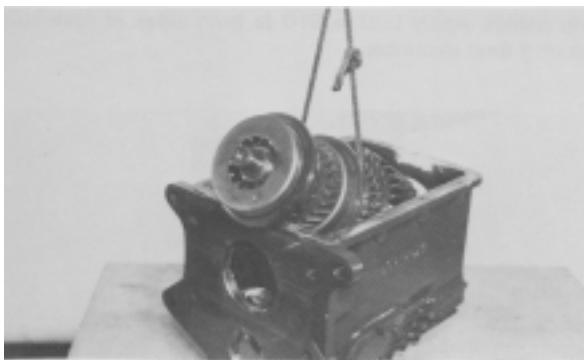

Figure 97 - Position mainshaft assembly in transmission as shown.



Figure 98 - With main drive gear needle rollers in place and greased, position main drive gear in housing bore. Align clutching teeth on main drive gear with teeth in 5th speed synchronizer cup.

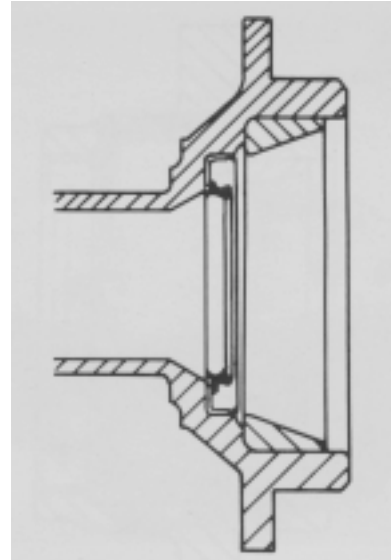

Figure 99 - Coat outer diameter of main drive bearing cap oil seal with Loctite 510. Press seal into drive gear bearing cap with lip of seal up. Install main drive gear taper bearing cup in bearing cap.

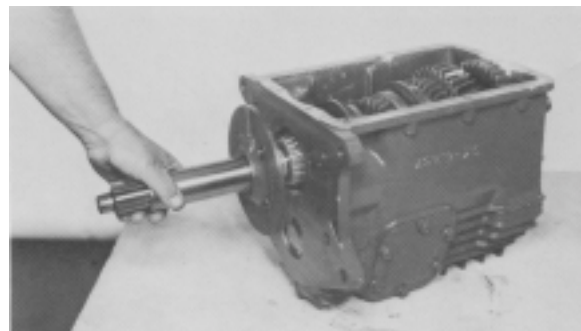

Figure 100 - Position main drive gear bearing cap gasket on bearing cap. Install bearing cap on main drive gear. Apply a band of Loctite 262 Thread Lock to bearing cap-screws. .125 [3,1mm] from end of thread .375[9,5mm] long. (Do not dip capscrews).

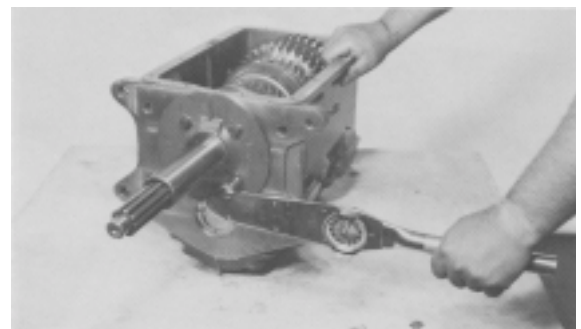

Figure 101 - Torque bearing capscrews 15 - 20 Ft. Lbs. Torque [20,4 - 27,1 N,m].

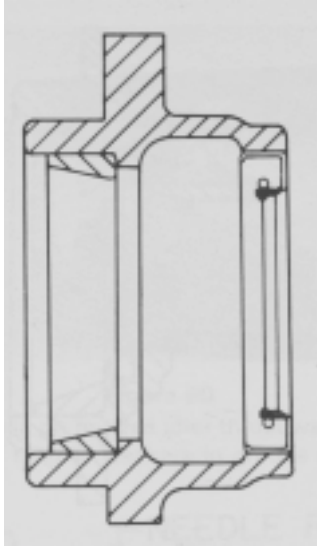

Figure 102 - Coat outer diameter of mainshaft rear oil seal with Loctite 510. Press seal into bearing cap with lip of seal down (in). Install mainshaft rear taper bearing cup in bearing cap.

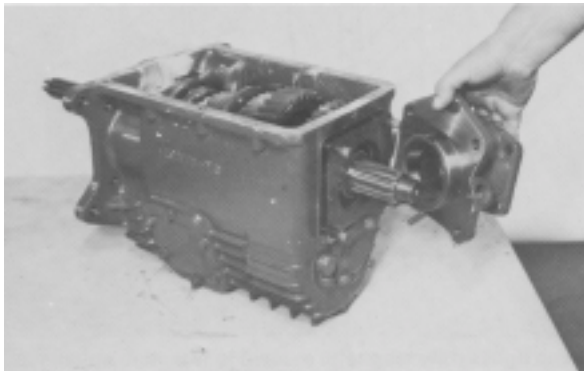

Figure 103 - Position the same shims that were removed at disassembly over mainshaft rear bearing cap studs. Install bearing cap. Install bearing cap lockwashers and stud nuts.

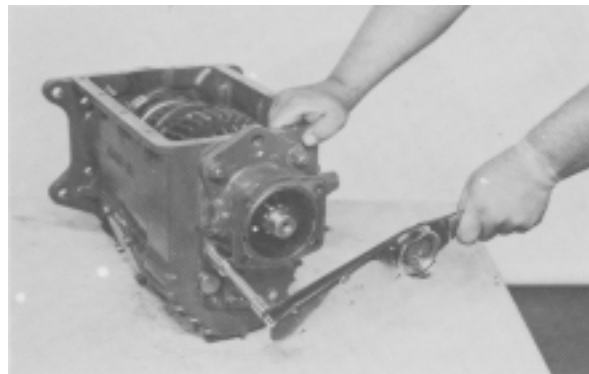

Figure 104 - Tighten bearing cap stud nuts 35 -45 Ft. Lbs. Torque [47,5 - 61,0 N.m].



Figure 105 - Place transmission in vertical position, with main drive gear pointing down. Install transmission output flange and nut. Roll main drive gear and mainshaft to seat front and rear taper bearings. Position a dial indicator as shown. Pry on output flange to get mainshaft and play. End play must be between .002 - .008. Add shims for more end play or remove shims for less end play.

NOTE: Each time a change is made, retorque stud nuts and roll mainshaft. Apply Loctite 510 to both sides of each shim during final assembly.



Figure 106 - Locate control cover gasket on transmission case. With transmission in neutral, position control cover over gears aligning shift forks in shift cover with gear shift hubs. If control cover is in neutral and transmission is in neutral, transmission drive gear should turn without output shaft turning.

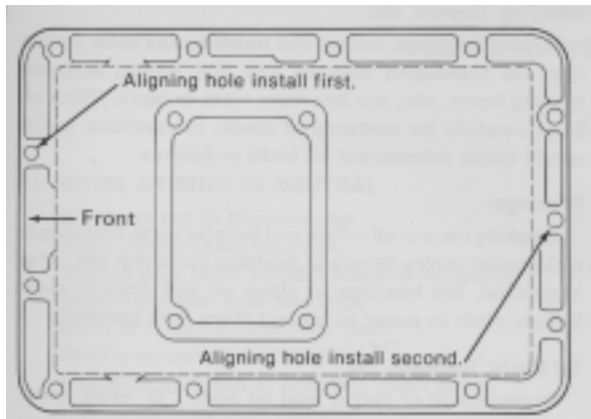

Figure 107 - Install two control cover capscrews in the locations shown. These are special alignment holes.

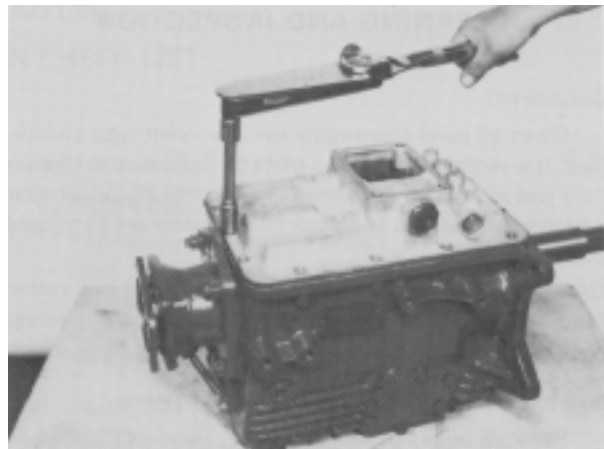

Figure 108 - Tighten screws in alignment holes 20 - 25 Ft. Lbs. Torque. Install remaining control cover capscrews and tighten to the same torque as the alignment screws.

CLEANING AND INSPECTION

CLEANING

Cleaning all parts thoroughly using solvent type cleaning fluid. It is recommended that parts be immersed in cleaning fluid and moved up and down slowly until all old lubricant and foreign material is dissolved and parts are thoroughly cleaned.

CAUTION: Care should be exercised to avoid skin rashes, fire hazards, and inhalation of vapors when using solvent type cleaners.

Bearings:

Remove bearings from cleaning fluid and strike against a block of wood to dislodge solidified particles of lubricant. Immerse again in cleaning fluid to flush out particles. Repeat above operation until bearings are thoroughly clean. Dry bearings using moisture-free compressed air. Be careful to direct air stream across bearing to avoid spinning. Do not spin bearings when drying. Bearing say be rotated slowly by hand to facilitate drying process.

Housings:

Clean interior and exterior of housings, bearing caps, etc. thoroughly. Cast parts may be cleaned in hot solution tanks with mild alkali solutions providing these parts do not have ground or polished surfaces. Parts should remain in solution long enough to be thoroughly cleaned and heated. This will aid the evaporation of the cleaning solution and rinse water. Parts cleaned in solution tanks must be thoroughly rinsed with clean water to remove all traces of alkali. Cast parts may also be cleaned with steam cleaner.

CAUTION: Care should be exercised to avoid inhalation of vapors and skin rashes when using alkali cleaners.

All parts cleaned must be thoroughly dried immediately by using moisture-free compressed air or soft, lintless absorbent wiping rages free of abrasive materials such as metal filings, contaminated oil or lapping compound.

INSPECTION

The importance of careful and thorough inspection of all parts cannot be overstressed. Replacement of all parts showing indication of wear or stress will eliminate costly and avoidable failures at a later date.

Gears and Shafts:

If magno-flux process is available, use process to check parts. Examine teeth on all gears carefully for wear, pitting, chipping, nicks, cracks, or scores. If gear teeth show spots where case hardening is worn through or cracked, replace with new gear. Small nicks may be removed with suitable hone. Inspect shafts to make certain they are not sprung, bent, or splines twisted, and that shaft are true.

Housing, Covers, Etc.:

Inspect housings, covers, and bearing caps to be certain they are thoroughly cleaned and that mating surfaces, bearing bores, etc., are free from nicks or burrs. Check all parts carefully for evidence of cracks or condition which would cause subsequent oil leaks or failures.

Bearings:

Carefully inspect all rollers and balls for wear, chipping or nicks to determine fitness of bearings for further use. After inspection, dip bearings in clean oil and wrap in clean lintless cloth or paper to protect them until installed.

Oil Seals, Gaskets, Etc.:

Replacement of spring load oil seals. "O"- rings, metal sealing rings, gaskets and snap rings is more economical when unit is disassembled than premature overhaul to replace these parts at a future time. Further, loss of lubricant through a worn seal may result in failure of other more expensive parts of the assembly. Sealing members should be handled carefully, particularly when being installed. Cutting, scratching, or curling under of lip of seal seriously impairs its efficiency.

TROUBLESHOOTER'S TRANSMISSION CHECKLIST

1. NOISE ARISING IN NEUTRAL

Misalignment of transmission
Worn transmission bearings
Scuffed gear tooth contact surfaces on gears
Worn mainshaft gear bushings
Worn or rough reverse idler gear
Sprung or work countershaft
Excessive backlash in constant mesh gear
Work mainshaft pilot bearing
Incorrect lubricant
Low lubricant level
Noisy main drive gear bearing

2. NOISE ARISING IN GEAR

Worn or rough mainshaft rear bearing
Excessive end play on mainshaft gears
Noisy speedometer gears
(See Conditions under #1)

3. NOISE ARISING OUTSIDE

Out-of-balance fan
Defective torsional dampener
Out-of-balance crankshaft
Out-of-balance flywheel
Out-of-balance clutch assembly
Loose engine mountings
Worn universal joints
U-joints improperly installed (Out of phase)
Misaligned or sprung driveshaft
Incorrect driveshaft assembly
Out-of-balance driveshaft
Out-of-balance parking brake drum

4. DIFFICULT SHIFTING

Improperly operating clutch (Does not release properly)
Shift hubs tight on Shift hub sleeve splines
Damaged pointing on clutching teeth
Misaligned mainshaft
Damaged or worn synchronizer assembly
Improper linkage adjustment
Worn or sprung shift fork

5. STICKING IN GEAR

Improperly operating clutch
Shift hubs tight on shift hub splines
Misaligned mainshaft
Improper linkage adjustment

6. SLIPPING OUT OF DIRECT

Misaligned of transmission on engine
Worn drive gear teeth
Worn clutching teeth on shift hub or drive gear
Insufficient tension on detent balls
Improper linkage adjustment
Excessive shift lever whip action
Worn torque lock on shift hub sleeve

7. SLIPPING OUT OF OTHER SPEEDS

Excessive clearance between mainshaft gear and mainshaft, or worn needle bearings
Excessive end play of mainshaft gear on mainshaft
Worn clutching teeth
Weak detent ball springs
Improper linkage adjustment
Worn torque lock on shift hub sleeve.

8. LOSS OF LUBRICANT

Lubricant level too high
Damaged gaskets
Damaged or worn oil seals
Cracked transmission housing
Use of incorrect lubricant
Oil return holes under bearing caps plugged

9. BEARING FAILURES

Use of incorrect lubricants
Improper bearing adjustment
Improper reassembly in unit overhaul
Lack of cleanliness in unit overhaul
Foreign particles in transmission

Copyright Eaton Corporation, 2012. Eaton hereby grant their customers, vendors, or distributors permission to freely copy, reproduce and/or distribute this document in printed format. It may be copied only in its entirety without any changes or modifications. THIS INFORMATION IS NOT INTENDED FOR SALE OR RESALE, AND THIS NOTICE MUST REMAIN ON ALL COPIES.

Note: Features and specifications listed in this document are subject to change without notice and represent the maximum capabilities of the software and products with all options installed. Although every attempt has been made to ensure the accuracy of information contained within, Eaton makes no representation about the completeness, correctness or accuracy and assumes no responsibility for any errors or omissions. Features and functionality may vary depending on selected options.

For spec'ing or service assistance, call 1-800-826-HELP (4357) or visit www.eaton.com/roadranger. In Mexico, call 001-800-826-4357.

Roadranger: Eaton and trusted partners providing the best products and services in the industry, ensuring more time on the road.

Eaton Corporation

Vehicle Group
P.O. Box 4013
Kalamazoo, MI 49003 USA
800-826-HELP (4357)
www.eaton.com/roadranger

Printed in USA

For parts or service call us
Pro Gear & Transmission, Inc.



1 (877) 776-4600

(407) 872-1901

parts@eprogear.com

906 W. Gore St.

Orlando, FL 32805

