

KIA, THE COMPANY



Thank you for becoming the owner of a new Kia vehicle.

As a global car manufacturer focused on building high-quality, value for money prices, Kia Motors is dedicated to providing you with a customer service experience that exceeds your expectations.

At all of our Kia dealerships you will be treated with warmth, hospitality and professionalism by people who care based on our **“Family-like Care”** promise.

All information contained in this Owner’s Manual is accurate at the time of publication. However, Kia reserves the right to make changes at any time so that our policy of continual product improvement can be carried out.

This manual applies to all models of this vehicle and includes descriptions and explanations of optional as well as standard equipment. As a result, you may encounter material in this manual that is not applicable to your specific Kia vehicle.

Enjoy your vehicle and Kia’s “Family-like Care” experience! ■

FOREWORD

Thank you for choosing a Kia vehicle.

When you require service, remember that your dealer knows your vehicle best. Your dealer has factory-trained technicians, recommended special tools, genuine Kia replacement parts and is dedicated to your complete satisfaction.

Because subsequent owners require this important information as well, this publication should remain with the vehicle if it is sold.

This manual will familiarize you with operational, maintenance and safety information about your new vehicle. It is supplemented by a Warranty and Maintenance book that provides important information on all warranties regarding your vehicle. If your vehicle is equipped with an audio system, you will also have a Kia Integrated Audio System manual explaining its operation. We urge you to read these publications carefully and follow the recommendations to help assure enjoyable and safe operation of your new vehicle.

Kia offers a great variety of options, components and features for its various models.

Therefore, the equipment described in this manual, along with the various illustrations, may not all be applicable to your particular vehicle.

The information and specifications provided in this manual were accurate at the time of printing. Kia reserves the right to discontinue or change specifications or design at any time without notice and without incurring any obligation. If you have questions, we recommend that you check with an authorised Kia dealer.

We assure you of our continuing interest in your motor-ing pleasure and satisfaction in your Kia vehicle.

© 2014 Kia Motors Corp.

All rights reserved. Reproduction by any means, elec-tronic or mechanical, including photocopying, recording, or by any information storage and retrieval system or translation in whole or part is not permitted without writ-en authorization from Kia Motors Corporation.

Printed in Korea

TABLE OF CONTENTS

Introduction

1

Your vehicle at a glance

2

Knowing your vehicle

3

Driving your vehicle

4

Driving tips

5

In case of an emergency

6

Maintenance

7

Specifications

8

Index

9

Introduction

1

How to use this manual / 1-2

2

Vehicle break-in process / 1-3

3

4

5

6

7

8

9

HOW TO USE THIS MANUAL

We want to help you get the greatest possible driving pleasure from your vehicle. Your Owner's Manual can assist you in many ways. We strongly recommend that you read the entire manual. Especially, in order to prevent death or injury, at the very least, you must read the WARNING and CAUTION sections spread throughout the manual, which are easily recognized by their special markings listed.

Illustrations complement the words in this manual to best explain how to enjoy your vehicle. By reading your manual, you learn about features, important safety information, and driving tips under various road conditions.

The general layout of the manual is provided in the Table of Contents. A good place to start is the index; it has an alphabetical listing of all information in your manual.

Sections: This manual has eight sections plus an index. Each section begins with a brief list of contents so you can tell at a glance if that section has the information you want.

You'll find various WARNING's, CAUTION's, and NOTICE's in this manual. These WARNING's, CAUTION's and NOTICE's were prepared to enhance your personal safety and continued satisfaction with Kia vehicle. You should carefully read and follow ALL procedures and recommendations provided in these WARNING's, CAUTION's and NOTICE's.

WARNING

A WARNING indicates a situation in which serious bodily injury or death could result if the warning is ignored.

CAUTION

A CAUTION indicates a situation in which personal injury, perhaps severe, could result if the caution is ignored.

*** NOTICE**

A NOTICE indicates a situation in which damage to your vehicle could result if the notice is ignored.

1

2

3

4

5

6

7

8

9

VEHICLE BREAK-IN PROCESS

No special break-in period is needed. By following a few simple precautions for the first 1,000 km (600 miles) you may add to the performance, economy and life of your vehicle.

- Do not race the engine.
- Do not maintain a single speed for long periods of time, either fast or slow. Varying engine speed is needed to properly break-in the engine.
- Avoid hard stops, except in emergencies, to allow the brakes to seat properly.
- Avoid full-throttle starts.

1

2

3

4

5

6

7

8

9

1

Your vehicle at a glance

2

Exterior overview / 2-2
Interior overview / 2-3

3

4

5

6

7

8

9

EXTERIOR OVERVIEW



1. Bonnet
2. Headlights
3. Wiper
4. Door
5. Side gate/Rear gate
6. Tyre
7. Window
8. Antenna

OPU012001R

INTERIOR OVERVIEW



1. Door lock/unlock button
 2. Power window switches *
 3. Brake/clutch fluid
 4. Instrument cluster
 5. Light control/Turn signals
 6. Wiper/Washer
 7. Glove box
 8. Bonnet release lever
 9. Headlight levelling device *
 10. Steering wheel
 11. Shift lever
 12. Parking brake
 13. Fog light *
 14. Hazard
 15. Audio *
 16. Climate control system *
 17. Cigar lighter
 18. Ashtray
 19. Warm-up switch
- * : if equipped

1

2

3

4

5

6

7

8

9

OPUA01205R/OPU002002R

Keys / 3-2
Remote keyless entry / 3-5
Door locks / 3-8
Window / 3-11

1

2

Knowing your vehicle

3

Seat / 3-13
Safety belts / 3-18
Air bag - supplemental restraint system / 3-31
Bonnet / 3-41
Rear gate / 3-42
Side gate / 3-43
Fuel filler / 3-44
Mirrors / 3-45
Interior lights / 3-46
Storage compartment / 3-47
Interior features / 3-48
Audio system / 3-51

4

5

6

7

8

9

KEYS

1

2

3

4



Record your key number

The key code number is stamped on the bar code tag attached to the key set. Should you lose your keys, this number will enable an authorised Kia dealer to duplicate the keys easily. Remove the bar code tag and store it in a safe place. Also, record the code number and keep it in a safe place (not in the vehicle).

5

6

7

8

9

■ Type A



■ Type B

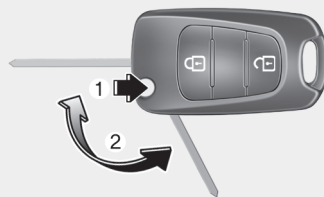

Key operations

Used to start the engine, lock and unlock the doors.

Type B

To unfold the key, press the release button then the key will unfold automatically.

To fold the key, fold the key manually whilst pressing the release button.

CAUTION

Do not fold the key without pressing the release button. This may damage the key.

⚠ WARNING - Ignition key

Leaving children unattended in a vehicle with the ignition key is dangerous even if the key is not in the ignition switch. Children copy adults and they could place the key in the ignition switch. The ignition key would enable children to operate power windows or other controls, or even make the vehicle move, which could result in serious bodily injury or even death. Never leave the keys in your vehicle with unsupervised children.

⚠ WARNING

Use only Kia original parts for the ignition key in your vehicle. If an aftermarket key is used, the ignition switch may not return to ON after START. If this happens, the starter will continue to operate causing damage to the starter motor and possible fire due to excessive current in the wiring.

Immobiliser system (if equipped)

Your vehicle may be equipped with an electronic engine immobiliser system to reduce the risk of unauthorised vehicle use.

Your immobiliser system is comprised of a small transponder in the ignition key and electronic devices inside the vehicle.

With the immobiliser system, whenever you insert your ignition key into the ignition switch and turn it to ON, it checks and determines and verifies if the ignition key is valid or not.

If the key is determined to be valid, the engine will start.

If the key is determined to be invalid, the engine will not start.

To deactivate the immobiliser system:

Insert the ignition key into the key cylinder and turn it to the ON position.

To activate the immobiliser system:

Turn the ignition key to the OFF position. The immobiliser system activates automatically. Without a valid ignition key for your vehicle, the engine will not start.

⚠ WARNING

In order to prevent theft of your vehicle, do not leave spare keys anywhere in your vehicle. Your Immobiliser password is a customer unique password and should be kept confidential. Do not leave this number anywhere in your vehicle.

- 1
- 2
- 3
- 4
- 5
- 6
- 7
- 8
- 9

1

2

3

*** NOTICE**

When starting the engine, do not use the key with other immobiliser keys around. Otherwise the engine may not start or may stop soon after it starts. Keep each key separately in order to avoid a starting malfunction.

4

5

6

⚠ CAUTION

Do not put metal accessories near the ignition switch. Metal accessories may interrupt the transponder signal and may prevent the engine from being started.

7

*** NOTICE**

We recommend that you consult an authorised Kia dealer.

8

9

⚠ CAUTION

The transponder in your ignition key is an important part of the immobiliser system. It is designed to give years of trouble-free service, however you should avoid exposure to moisture, static electricity and rough handling. Immobiliser system malfunction could occur.

⚠ CAUTION

Do not change, alter or adjust the immobiliser system because it could cause the immobiliser system to malfunction. We recommend that the system be serviced by an authorised Kia dealer.

Malfunctions caused by improper alterations, adjustments or modifications to the immobiliser system are not covered by your vehicle manufacturer warranty.

REMOTE KEYLESS ENTRY (IF EQUIPPED)

■ Type A



1PUA2002

■ Type B



OPU040002

Remote keyless entry system operations

Lock (1)

1. Close all doors.
2. Press the lock button.
3. The hazard warning light will blink once to indicate that all doors are locked.

Unlock (2)

1. Press the unlock button.
2. The hazard warning lights will blink twice to indicate that all doors are unlocked.

*** NOTICE**

After unlocking all doors, the doors will lock automatically unless a door is opened within 30 seconds.

Transmitter precautions

*** NOTICE**

The transmitter will not work if any of following occur:

- The ignition key is in ignition switch.
- You exceed the operating distance limit (about 10 m [30 feet]).
- The battery in the transmitter is weak.
- Other vehicles or objects may be blocking the signal.
- The weather is extremely cold.
- The transmitter is close to a radio transmitter such as a radio station or an airport which can interfere with normal operation of the transmitter.

When the transmitter does not work properly, open and close the door with the ignition key. If you have a problem with the transmitter, we recommend that you contact an authorised Kia dealer.

(Continued)

1

2

3

4

5

6

7

8

9

1

2

3

4

5

6

7

8

9

(Continued)

- If the transmitter is in close proximity to your cell phone or smart phone, the signal from the transmitter could be blocked by normal operation of your cell phone or smart phone. This is especially important when the phone is active such as making call, receiving calls, text messaging, and/or sending/receiving emails. Avoid placing the transmitter and your cell phone or smart phone in the same pants or jacket pocket and maintain adequate distance between the two devices.

CAUTION

- *Keep the transmitter away from water or any liquid. If the keyless entry system is inoperative due to exposure to water or liquids, it will not be covered by your manufacturer vehicle warranty.*
- *Keep the transmitter away from electromagnetic materials that blocks electromagnetic waves to the key surface.*

CAUTION

Changes or modifications not expressly approved by the party responsible for compliance could void the user's authority to operate the equipment. If the keyless entry system is inoperative due to changes or modifications not expressly approved by the party responsible for compliance, it will not be covered by your manufacturer's vehicle warranty.

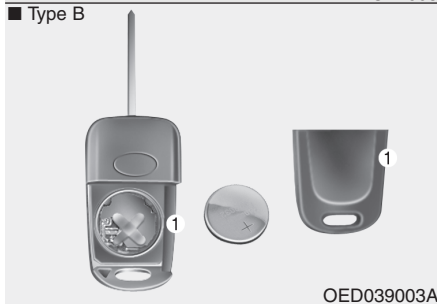
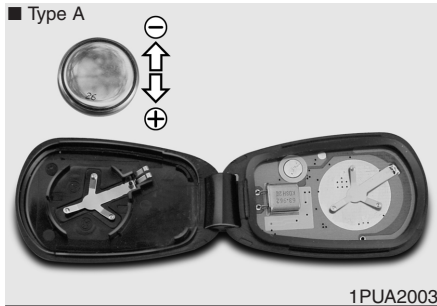

Battery replacement

The transmitter uses a 3 volt lithium battery which will normally last for several years. When replacement is necessary, use the following procedure.

1. Insert a slim tool into the slot and gently pry open the transmitter centre cover (1).
2. Replace the battery with new one. When replacing the battery, make sure the battery positive “+” symbol faces up as indicated in the illustration.
3. Install the battery in the reverse order of removal.

For replacement transmitters, we recommend that you contact an authorised Kia dealer.

CAUTION

- *The keyless entry system transmitter is designed to give you years of trouble-free use, however it can malfunction if exposed to moisture or static electricity. If you are unsure how to use your transmitter or replace the battery, contact an authorised Kia dealer.*
- *Using the wrong battery can cause the transmitter to malfunction. Be sure to use the correct battery.*
- *To avoid damaging the transmitter, don't drop it, get it wet, or expose it to heat or sunlight.*

CAUTION

An inappropriately disposed battery can be harmful to the environment and human health. Dispose the battery according to your local law(s) or regulation.

1

2

3

4

5

6

7

8

9

DOOR LOCKS

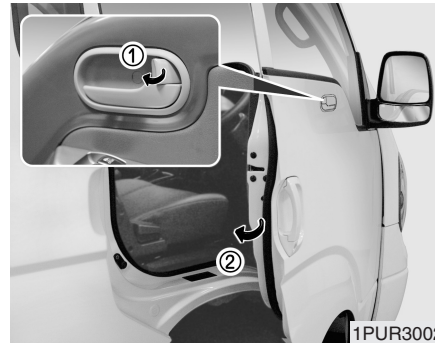
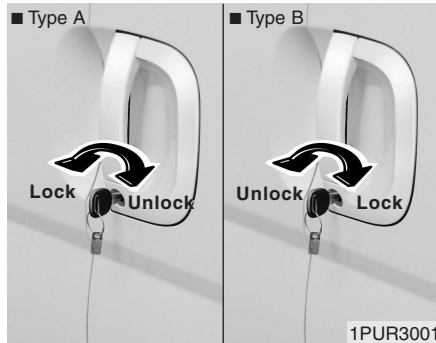

* NOTICE

If the door is locked/unlocked multiple times in rapid succession with either the vehicle key or door lock button, the system may stop operating temporarily in order to protect the circuit and prevent damage to system components.

Operating door locks from outside the vehicle

- Turn the key toward rear of vehicle to lock and toward front of vehicle to unlock. (Type A)
- Turn the key toward rear of vehicle to unlock and toward front of vehicle to lock. (Type B)
- Once the doors are unlocked, it may be opened by pulling the door handle.
- When closing the door, push the door by the hand. Make sure that doors are closed securely.

To lock a door without the key, push the inside door lock button (①) to the “Lock” position and close the door (②).

* NOTICE

Always remove the ignition key, engage the parking brake, close all windows and lock all doors when leaving your vehicle unattended.

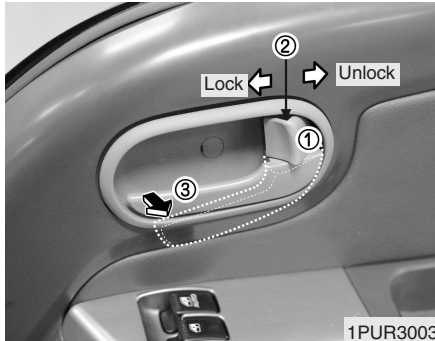

Operating door locks from inside the vehicle

- To unlock a door, push the door lock button to the “Unlock” position.
- To lock a door, push the door lock button (①) to the “Lock” position. If the door is locked, red part (②) of the knob becomes invisible.
- To open a door, pull the door handle (③).

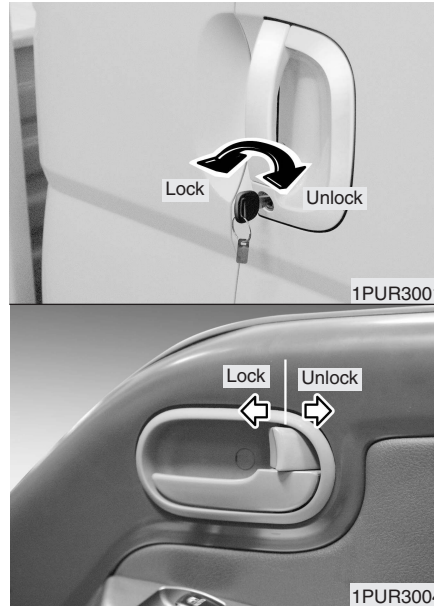

Central door lock system (if equipped)

If you lock/unlock the driver’s door with a key or door lock button, front doors will lock/unlock automatically.

CAUTION

- *The doors should always be fully closed and locked whilst the vehicle is in motion to prevent accidental opening of the door. Locked doors will also discourage potential intruders when the vehicle stops or slows.*
- *Be careful when opening doors and watch for vehicles, motorcycles, bicycles or pedestrians approaching the vehicle in the path of the door. Opening a door when something is approaching can cause damage or injury.*

1
2
3
4
5
6
7
8
9

1

2

3

4

5

6

7

8

9

⚠ WARNING

Leaving your vehicle unlocked can invite theft or possible harm to you or others from someone hiding in your vehicle whilst you are gone. Always remove the ignition key, engage the parking brake, close all windows and lock all doors when leaving your vehicle unattended.

⚠ WARNING - Unattended children

An enclosed vehicle can become extremely hot, causing death or severe injury to unattended children or animals who cannot escape the vehicle. Furthermore, children might operate features of the vehicle that could injure them, or they could encounter other harm, possibly from someone gaining entry to the vehicle. Never leave children or animals unattended in your vehicle.

WINDOWS

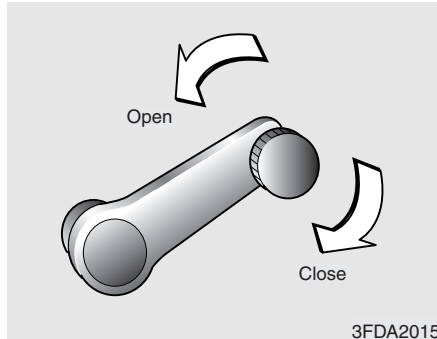

3FDA2015

Manual windows (if equipped)

Use the window crank to open and close each window.

* NOTICE

If you notice buffeting and pulsation (wind shock) with either side window open, you should open the opposite window slightly to reduce the condition.

Power windows (if equipped)

The ignition switch must be in the ON position for power windows to operate. Front doors have a power window switch that controls that door's window.

* NOTICE

To prevent the power window system from the possibility of damage, do not open or close two windows at the same time. This will also ensure the longevity of the fuse.

CAUTION

- *Make sure heads and hands are safely out of the way before closing a window.*
- *Do not allow children to play with the power windows. Serious injury can result from unintentional window operation by the child.*
- *Do not extend face or arms outside through the window opening whilst driving.*
- *Always double check to make sure all arms, hands and other obstructions are safely out of the way before closing a window.*

1

2

3

4

5

6

7

8

9

1

2

3

4

5

6

7

8

9

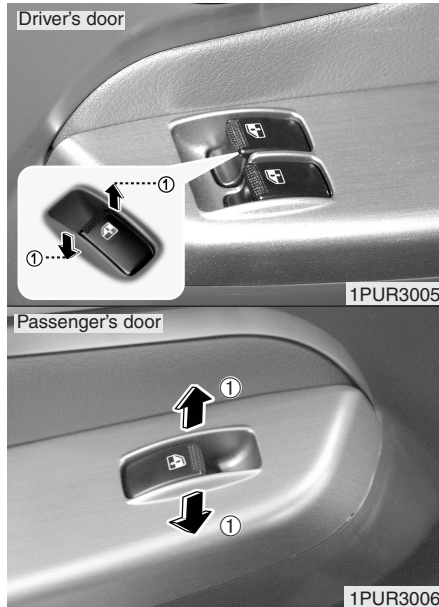

Window opening and closing

The driver's door has a master power window switch that controls the front windows in the vehicle. To open or close a window, press down (①) or pull up (①) the front portion of the corresponding switch.

Power window timer (if equipped)

The power windows can be operated for approximately 30 seconds after the ignition key is removed or turned to the ACC or LOCK position. However, if the front doors are opened, the power windows cannot be operated even within the 30 seconds after the ignition key removal.

SEAT

WARNING

- Loose objects in the driver's foot area could interfere with the operation of the foot pedals, possibly causing an accident. Loose objects might interfere with the seat slide mechanism. Do not place anything under the front seats.
- Children should never be left unattended in the car.

WARNING - Driver's seat

- Never attempt to adjust seat whilst the vehicle is moving. This could result in loss of control, and an accident causing death, serious injury, or property damage.
- Do not allow anything to interfere with the normal position of the seatback. Storing items against a seatback or in any other way interfering with proper locking of a seatback could result in serious or fatal injury in a sudden stop or collision.
- Always drive and ride with your seatback upright and the lap portion of the safety belt, or lap belt, snug and low across the hips. This position puts your safety belts in the best position to protect you in case of an accident.

Front seat adjustment

Adjust the seat before driving, and make sure the seat is locked securely by trying to move forward and backward without using the control lever. If the seat moves, it is not locked properly.

1

2

3

4

5

6

7

8

9

1

2

3

4

5

6

7

8

9

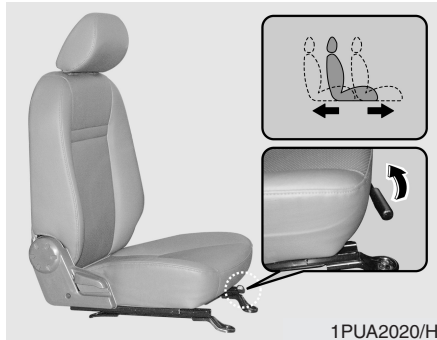

1PUA2020/H

Adjusting the seat forward and backward (driver's seat)

To move the seat forward or backward:

1. Pull the seat slide adjustment lever under the front edge of the seat cushion up and hold it.
2. Slide the seat to the position you desire.
3. Release the lever and make sure the seat is locked in place.

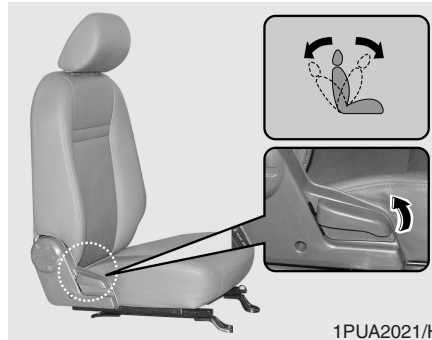

1PUA2021/H

Adjusting the seatback recliner (if equipped)

To recline the seatback:

1. Lean forward slightly and lift up on the seatback recline lever located on the outside of the seat, at the rear.
2. Carefully lean back on the seat and adjust the seatback to the position you desire.
3. Release the lever and make sure the seatback is locked in place. (The lever **MUST** return to its original position for the seatback to lock.)

⚠ WARNING

Driving or riding in a vehicle with a front seatback reclined could lead to serious or fatal injury in an accident. If a front seat is reclined during an accident, the occupant's hips may slide under the lap portion of the safety belt applying great force to the unprotected abdomen or neck. Serious or fatal internal injuries could result. Keep the seatbacks in a comfortably upright position whenever the vehicle is in motion.

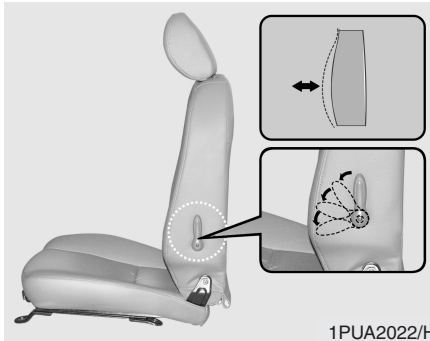

Lumbar support (for driver's seat)

The lumbar support can be adjusted by moving the lever. Pivoting the lever increases or decreases lumbar support.

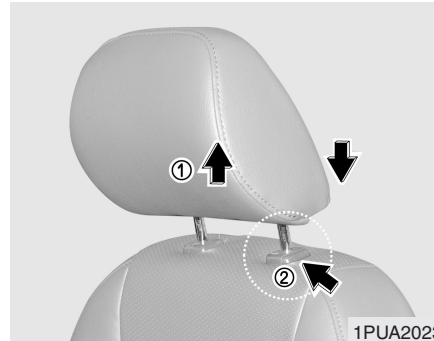

Headrest adjustment

Adjusting the height up and down

The headrest not only provides comfort for the driver and passengers, but also helps to protect the head and neck in the event of a collision.

To raise the headrest, pull it up to the desired position. To lower the headrest, push and hold the release button on the headrest support and lower the headrest to the desired position. For best protection, adjust the headrest so its centre is as high as your ears.

Removal

To remove the headrest, raise it as far as it can go then press the release button whilst pulling upward.

⚠ WARNING

To reduce the risk of head and neck injuries, do not drive the vehicle with the headrest removed or improperly positioned.

Do not adjust the driver's headrest whilst driving.

- 1
- 2
- 3
- 4
- 5
- 6
- 7
- 8
- 9

1

2

3

4

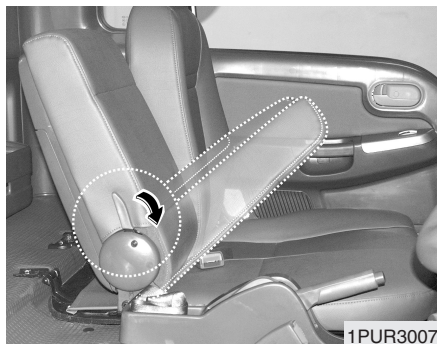

Centre seat

To use it by console box, push down the release lever beside the seat and fold the seatback forward.

To use it by seat, push down the release lever beside the seat and stand the seatback upright.

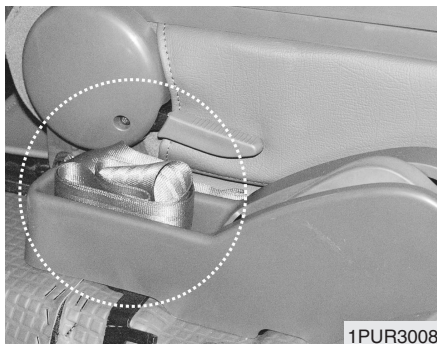

CAUTION

When you fold the centre seatback, put the centre safety belt into the parking brake lever cover. Doing so can prevent the safety belt from being damaged by the centre seatback.

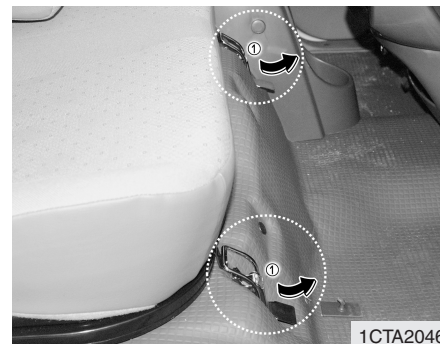

Engine room access

Passenger's seat

To access the engine room under the passenger's seat,

1. Fold the passenger's seatback and centre seatback.
2. Unsnap the clasps (①) at the front of the seat cushion.

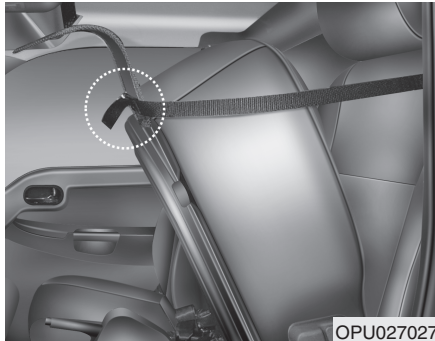

3. Lift the seat cushion and fasten the seat cushion with the strap.

⚠ WARNING

Do not leave gloves, rags or any other combustible material in the engine compartment. Doing so may cause a heat-induced fire.

*** NOTICE**

The engine oil filler cap and radiator cap is located below passenger's seat.

⚠ WARNING - 2.5L Engine

Never work on injection system with engine running or within 30 seconds after shutting off engine. High-pressure pump, rail, injectors and high-pressure pipes are subject to high pressure even after the engine stopped. The fuel jet produced by fuel leaks may cause serious injury, if it touches the body. People using pacemakers should not move than 30cm closer to the ECU or wiring harness within the engine room whilst engine is running, since the high currents in the electronic engine control system produce considerable magnetic fields.

- 1
- 2
- 3
- 4
- 5
- 6
- 7
- 8
- 9

SAFETY BELTS

Safety belt restraint system

⚠ WARNING - Safety belts

- **To minimise the risk of serious or fatal injury in an accident, the driver and all passengers should use the appropriate safety restraints for their age and size.**
- **Never wear a seat belt over fragile objects. If there is a sudden stop or impact, the seat belt can damage it.**

We strongly recommend that the driver and all passengers be properly restrained at all times by using the safety belts provided with the vehicle. Proper use of the safety belts decreases the risk of severe injury or death in accidents or sudden stops.

Front seats have lap/shoulder belts. Inertial locks in the safety belt retractors allow all of the lap/shoulder safety belts to remain unlocked during normal vehicle operation. This allows the occupants some freedom of movement and increased comfort whilst using the safety belts. If a force is applied to the vehicle, such as a strong stop, a sharp turn, or a collision, the safety belt retractors will automatically lock the safety belts.

Since the inertial locks do not require a collision in order to lock up, you may become aware of the safety belts locking whilst braking or going around sharp corners.

Safety belts provide the best restraint when:

- The seatback is upright.
- The occupant is sitting upright (not slouched).
- The lap belt is snug across the hips.
- The shoulder belt is snug across the chest.
- The knees are straight forward.

To help you remember to fasten your safety belt, a warning light will come on.

⚠ WARNING - Australian design rules

- Seatbelts are designed to bear upon the bony structure of the body, and should be worn low across the front of the pelvis or the pelvis, chest and shoulders, as applicable; wearing the lap section of the belt across the abdominal area must be avoided.
- Seatbelts should be adjusted as firmly as possible, consistent with comfort, to provide the protection for which they have been designed. A slack belt will greatly reduce the protection afforded to the wearer.
- Care should be taken to avoid contamination of the webbing with polishes, oils and chemicals, and particularly battery acid. Cleaning may safely be carried out using mild soap and water.

(Continued)

(Continued)

- The belts should be replaced if webbing becomes frayed, contaminated or damaged.
- It is essential to replace the entire assembly after it has been worn in a severe impact even if damage to the assembly is not obvious.
- Belts should not be worn with straps twisted.
- Each belt assembly must only be used by one occupant; it is dangerous to put a belt around a child being carried on the occupant's lap.
- No modifications or additions should be made by the user which will either prevent the seat belt adjusting devices from operating to remove slack, or prevent the seat belt assembly from being adjusted to remove slack.

⚠ WARNING - After a collision

- Lap/shoulder belt assemblies may be stretched or damaged when subjected to the stress and forces of a collision.
- The entire restraint system should be inspected following any collision. All belts, retractors, anchors and hardware damaged by a collision should be replaced before the vehicle is operated again.

1

2

3

4

5

6

7

8

9

1

⚠ WARNING - Cargo area

Passengers should never be allowed to ride in the cargo area of a vehicle. No safety belts are provided for the cargo area. Persons riding in the vehicle without a fastened safety belt are much more likely to suffer serious bodily injury or death during an accident.

2

3

4

5

6

7

8

9

⚠ WARNING - Twisted belts

A twisted or jammed safety belt cannot restrain you properly. If you cannot untwist or unjam the safety belt, we recommend that you contact an authorised Kia dealer. Never drive or ride with a twisted or jammed safety belt.

⚠ WARNING - Belt use

Safety belts must be used correctly to work properly in an accident. Each seating position in your vehicle has a specific safety belt assembly that includes a buckle and tongue designed to be used together.

For greatest effectiveness, follow these guidelines in using safety belts:

- Use the shoulder portion of the safety belt on the outside shoulder only. Never wear the shoulder portion under the arm.
- Never swing the safety belt around your neck to fit over the inside shoulder.
- Never wear the shoulder portion of the safety belt across the neck or face.

(Continued)

(Continued)

- Wear the lap portion as low as possible. Be sure that the lap belt fits snugly around the hips. Never wear a lap portion of a lap/shoulder belt over your waist; it should always go over the stronger area of your hips.
- Never use a single safety belt for more than one person.
- The front seatbacks should always remain in a comfortable, upright position when the vehicle is moving.

⚠ WARNING - Safety belt care

- A damaged belt may not give you the protection you need in an accident.
- Inspect your safety belts periodically for excessive wear or damage. Pull out each belt fully and look for fraying, cuts, burns or other damage. Pull the safety belt out and let it retract a number of times. Make sure that the lap/shoulder belts return smoothly and easily into the retractor.
- Check the latches to make sure they latch and release without interference or delay.
- Never close the doors on any part of the lap or shoulder belt.
- Any belt not in good condition or in good working order should be promptly replaced.

⚠ CAUTION

Never close the doors on any part of the lap or shoulder belt. It can damage the safety belt or buckle which could increase the risk of injury in case of an accident.



⚠ CAUTION

When you fold the centre seatback, put the centre safety belt into the rear seatback pocket of the driver's seat. Doing so can prevent the safety belt from being damaged by the centre seatback.

- 1
- 2
- 3
- 4
- 5
- 6
- 7
- 8
- 9

1

2

3

4

5

6

7

8

9



Safety belt warning light

As a reminder to the driver and passenger, safety belt warning light will blink for approximately 6 seconds each time you turn the ignition switch ON.



Lap/shoulder belt

To fasten the front lap/shoulder belt:

1. Grasp the buckle and tongue plate.
2. Slowly pull the lap/shoulder belt out from the retractor.

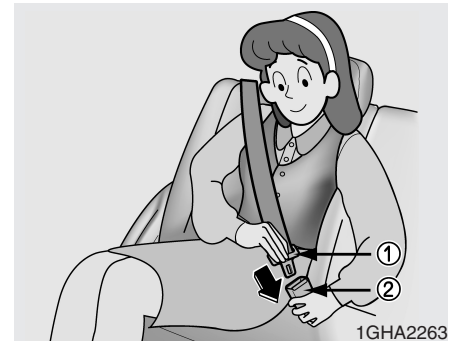

3. Insert the tongue plate (①) into the open end of the buckle (②) until an audible “click” is heard, indicating the belt is locked in the buckle.

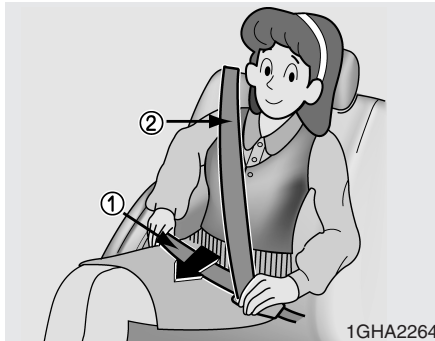

4. Position the lap portion (①) of the belt across your lap as **LOW ON THE HIPS** as possible to reduce the risk of sliding under it during an accident. Adjust the belt to a **SNUG FIT** by pulling up on the shoulder portion (②) of the safety belt. The belt retractor is designed to take up excess webbing automatically and to maintain tension on the belt. For your safety, do not put any excess slack into the safety belt at any location.

*** NOTICE**

If you are not able to pull out the safety belt from the retractor, firmly pull the belt out and release it. Then you will be able to pull the belt out smoothly.

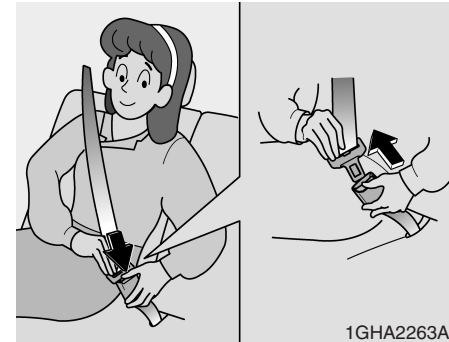

To unfasten the front lap/shoulder belt:

Press the release button on the buckle and allow the belt to slowly retract.

1
2
3
4
5
6
7
8
9

- 1
- 2
- 3
- 4
- 5
- 6
- 7
- 8
- 9

⚠ WARNING

- The seatbacks should always remain in a comfortable, upright position whilst the vehicle is in motion. The safety belt system will provide the most protection with the seatbacks in an upright position.
- Never wear the shoulder portion of the safety belt under the outside arm or behind the back.
- Never wear the shoulder portion of the safety belt across the neck or face.
- Wear the lap portion of the safety belt as low on the hips as possible. Be sure the lap belt fits snugly around the hips. Never wear the lap belt over your waist.

(Continued)

(Continued)

- Never drive or ride with a twisted or jammed safety belt. If you cannot untwist or unjam the safety belt, we recommend that you contact an authorised Kia dealer.
- Never use a single belt to restrain more than one person at a time.

Failure to follow these warnings will increase the risk and severity of injury in an accident.

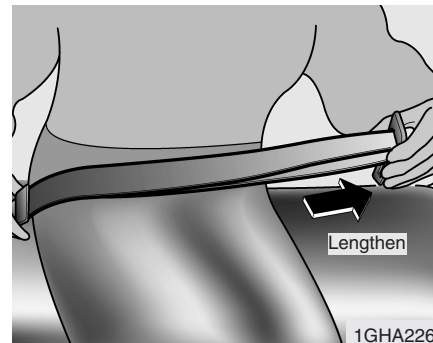

Lap belt (if equipped)

To fasten the lap belt:

1. Grasp the tongue plate end and pull it low over the abdomen.

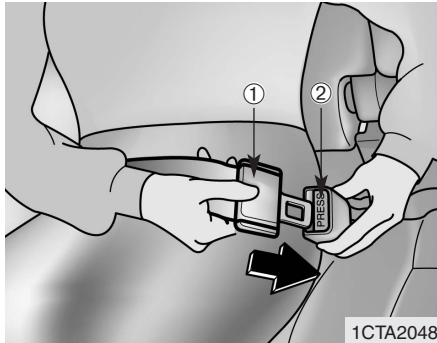

2. Insert the tongue plate (1) into the open end of the buckle (2) until an audible “click” is heard, indicating the latch is locked. Make sure the belt is not twisted.



3. Grasp the free portion of the belt webbing and pull until the belt is snug over the hips and lower abdomen. If it becomes necessary to lengthen or shorten the belt, hold the latch plate tongue at right angles to the webbing and pull.

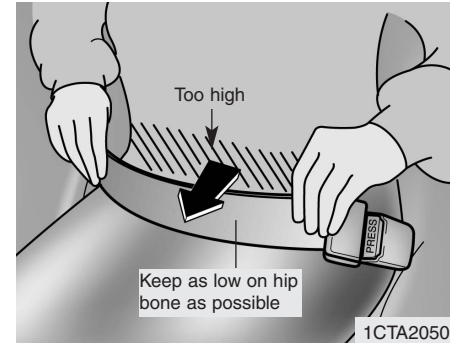

4. Make sure that the belt is placed as **LOW ON THE HIPS** as possible.

1
2
3
4
5
6
7
8
9

1

2

3

4

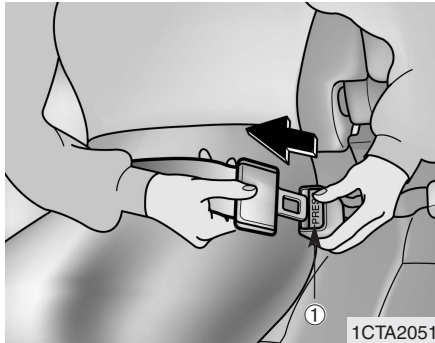

To unfasten the lap belt:

Press the release button (①) on buckle.

5

6

7

8

9

⚠ WARNING - Lap belt

Be sure the lap belt is positioned snugly around the hips, and not on the waist. Failure to position the lap belt snugly around the hips will increase the chance and severity of injury in the event of a collision.

Proper use and care of the safety belt system

To ensure that the safety belts provide the maximum protection, please follow these instructions:

- Use the belts at all times - even on short trips.
- If the safety belt is twisted, straighten it prior to use.
- Keep sharp edges and damaging objects away from the belts.
- Periodically inspect belt webbing, anchors, buckles and all other parts for signs of wear and damage. Replace damaged, excessively worn or questionable parts immediately.

- To clean the belt webbing, use a mild soap solution recommended for cleaning upholstery or carpets. Follow the instructions provided with the soap.
- Do not make modifications or additions to the safety belt.
- After wearing a safety belt, make sure it fully retracts to the stowed position. Do not allow the belt to get caught in the door when you close it.

⚠ WARNING

Do not bleach or dye the webbing because this may weaken the webbing fibers and allow them to fail when loaded in a collision.

Restraint of pregnant women

Pregnant women should wear lap/shoulder belt assemblies whenever possible according to specific recommendations by their doctors. The lap portion of the belt should be worn AS SNUGLY AND LOW AS POSSIBLE.

⚠ WARNING - Pregnant women

Pregnant women must never place the lap portion of the safety belt over the area of the abdomen where the fetus is located or above the abdomen where the belt could crush the fetus during an impact.

Restraint of infants and small children

To increase their safety, infants and young children should always be restrained by a restraint system approved for their age and size.

Never allow a child to stand or kneel on the seat of a moving vehicle. Never allow a safety belt to be placed around both a child and an adult or around two children at the same time.

It is best for children to be seated in the rear seat.

⚠ WARNING - Children on laps

Never hold a child on your lap or in your arms in a moving vehicle.

Even a very strong person cannot hold onto a child in the event of even a minor collision.

⚠ CAUTION - Hot metal parts

Safety belts and seats can become hot in a vehicle that has been closed during warm/hot weather; they could burn a child. Check seat covers and buckles before you place a child anywhere near them.

1

2

3

4

5

6

7

8

9

1

Many companies manufacture child restraint systems (often called child seats) for infants and small children. An acceptable child restraint system must always satisfy the Safety Standards of your country. Make sure that any child-restraint system you use in your vehicle is labelled as complying with those safety standards.

2

3

The child-restraint system should be chosen to fit both the size of the child and the size of the vehicle seat. Be sure to follow any instructions provided by the child-restraint system manufacturer when installing the child-restraint system.

4

5

6

7

8

9

Restraint of larger children

As children grow, they may need to use new child-restraint systems, including larger child seats or booster seats, which are appropriate for their increased size.

A child who has outgrown available child-restraint systems should use the belts provided in the vehicle. When seated in the rear outboard seats, the child should be restrained by the lap/shoulder belt.

If the shoulder belt portion slightly touches the child's neck or face, try placing the child closer to the centre of the vehicle. If the shoulder belt still touches their face or neck they may need to be returned to a child restraint system. In addition, after-market devices are available from independent manufacturers which help pull the shoulder belt down and away from the child's face or neck.

WARNING - Shoulder belts on small children

- **Never allow a shoulder belt to be in contact with a child's neck or face whilst the vehicle is in motion.**
- **If safety belts are not properly worn and adjusted, there is a risk of death or serious injury to such a child.**

Installation on the front seats

⚠ WARNING

- Before installing the child restraint system, read the instructions supplied by the child restraint system manufacturer.
- Failure to observe this manual instructions regarding child restraint system and the instructions provided with the child restraint system could increase the chance and/or severity of injury in an accident.
- If the child restraint seat is not anchored properly, the risk of a child being seriously injured or killed in a collision greatly increases.

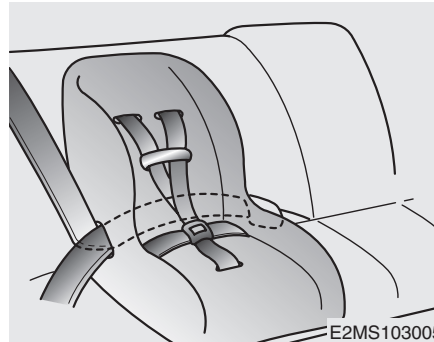

Installing a child restraint system by lap/shoulder belt (on the outboard front seat)

To install a child restraint system on the outboard front seat, do the following:

1. Place the child restraint system in the desired position.
2. Extend the shoulder/lap belt from its retractor.

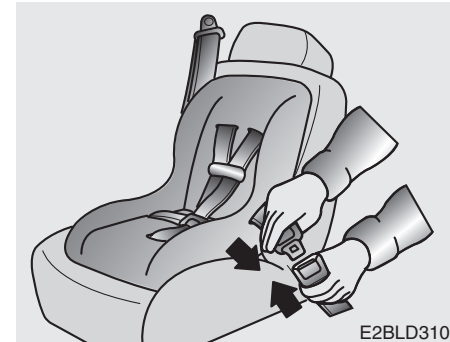

3. Route the lap/shoulder belt through the restraint according to the seat manufacturer's instructions.

1
2
3
4
5
6
7
8
9

1

2

3

4

5

6

7

8

9



4. Buckle the seat belt and allow the seat belt to take up any slack. After installation of the child restraint system, try to move it in all directions to be sure the child restraint system is securely installed.

If you need to tighten the belt, pull more webbing toward the retractor. When you unbuckle the seat belt and allow it to retract, the retractor will automatically revert back to its normal seated passenger emergency locking usage condition.



Installing a child restraint system by lap belt (on the centre front seat)

To install a child restraint system on the centre front seats, do the following:

1. Place the child restraint system on the centre front seat.
2. Extend the latch plate tongue of the lap belt.

3. Route the lap belt through the restraint according to the seat manufacturer's instructions.
4. Buckle the seat belt and adjust the lap belt for a snug hold on the child restraint by pulling on the loose end of the belt. After installation of the child restraint system, try to move it in all directions to be sure the child restraint system is securely installed.

AIR BAG - SUPPLEMENTAL RESTRAINT SYSTEM (IF EQUIPPED)



(1) Driver's air bag*

* : if equipped

⚠ WARNING

- Even in vehicles with air bag, you must always wear the safety belts provided in order to minimise the risk and severity of injury in the event of a collision or rollover.

- SRS and pretensioners contain explosive chemicals.

If scraping a vehicle without removing SRS and pretensioners from a vehicle, it may cause fire. Before scraping a vehicle, we recommend that you contact an authorized Kia dealer.

- Keep the SRS parts and wirings away from water or any liquid. If the SRS components are inoperative due to exposure to water or liquids, it may cause fire or severe injury.

1

2

3

4

5

6

7

8

9

How does the air bag system operate

- 1 • Air bag is activated (able to inflate if necessary) only when the ignition switch is turned to the ON or START position.
- 2 • Air bag inflates instantly in the event of serious frontal in order to help protect the occupants from serious physical injury.
- 3 • There is no single speed at which the air bag will inflate.
- 4

Generally, air bag is designed to inflate based upon the severity of a collision and its direction. These two factors determine whether the sensors produce an electronic deployment/ inflation signal.

- 5
- 6
- 7 • Air bag deployment depends on a number of factors including vehicle speed, angles of impact and the density and stiffness of the vehicles or objects which your vehicle hits in the collision. The determining, factors are not limited to those mentioned above.
- 8
- 9

- The front air bag will completely inflate and deflate in an instant.

It is virtually impossible for you to see the air bag inflates during an accident. It is much more likely that you will simply see the deflated air bag hanging out of their storage compartments after the collision.

- In order to help provide protection in a severe collision, the air bag must inflate rapidly. The speed of air bag inflation is a consequence of extremely short time in which a collision occurs and the need to get the air bag between the occupant and the vehicle structures before the occupant impacts those structures. This speed of inflation reduces the risk of serious or life-threatening injuries in a severe collision and is thus a necessary part of air bag design.

However, air bag inflation can also cause injuries which can include facial abrasions, bruises and broken bones because the inflation speed also causes the air bag to expand with a great deal of force.

- There are even circumstances under which contact with the steering wheel air bag can cause fatal injuries, especially if the occupant is positioned excessively close to the steering wheel.

⚠ WARNING

- To avoid severe personal injury or death caused by deploying air bag in a collision, the driver should sit as far back from the steering wheel air bag as possible (at least 250 mm (10 inches) away).
- Air bag inflation may cause injuries including facial or bodily abrasions, injuries from broken glasses or burns.

Noise and smoke

When the air bag inflates, they make a loud noise and they leave smoke and powder in the air inside of the vehicle. This is normal and is a result of the ignition of the air bag inflator. After the air bag inflates, you may feel substantial discomfort in breathing due to the contact of your chest with both the seat belt and the air bag, as well as from breathing the smoke and powder. **Open your doors and/or windows as soon as possible after impact in order to reduce discomfort and prevent prolonged exposure to the smoke and powder.**

Though smoke and powder are non-toxic, it may cause irritation to the skin (eyes, nose and throat, etc.). If this is the case, wash and rinse with cold water immediately and consult the doctor if the symptom persists.



W7-147

Air bag warning light

The purpose of the air bag warning light in your instrument panel is to alert you of a potential problem with your air bag - Supplemental Restraint System (SRS).

When the ignition switch is turned ON, the warning light should illuminate for approximately 6 seconds, then go off.

Have the system checked if:

- The light does not turn on briefly when you turn the ignition ON.
- The light stays on after illuminating for approximately 6 seconds.
- The light comes on whilst the vehicle is in motion.

⚠ WARNING

When the air bag deploys, the air bag related parts in the steering wheel is very hot. To prevent injury, do not touch the air bag storage areas internal components immediately after an air bag has inflated.

1

2

3

4

5

6

7

8

9

1

2

3

4

5

6

7

8

9

Driver's air bag



OPU022447

Driver's air bag (if equipped)

Your vehicle is equipped with a Supplemental Restraint (Air Bag) System and lap/shoulder belts at the driver seating positions.

The indications of the system's presence are the letters "AIR BAG" embossed on the air bag pad cover in the steering wheel.

The SRS consists of air bag installed under the pad covers in the centre of the steering wheel.

The purpose of the SRS is to provide the vehicle's driver with additional protection than that offered by the seat belt system alone in case of a frontal impact of sufficient severity.

⚠ WARNING

- If an air bag deploys, there may be a loud noise followed by a fine dust released in the vehicle. These conditions are normal and are not hazardous - the air bag is packed in this fine powder. The dust generated during air bag deployment may cause skin or eye irritation as well as aggravate asthma for some persons.

Always wash all exposed skin areas thoroughly with luke-warm water and a mild soap after an accident in which the air bag was deployed.

- The SRS can function only when the ignition switch is in the ON position.

(Continued)

(Continued)

- **Before you replace a fuse or disconnect a battery terminal, turn the ignition switch to the LOCK position and remove the ignition key. Never remove or replace the air bag related fuse(s) when the ignition switch is in the ON position. Failure to heed this warning will cause the SRS air bag warning light to illuminate.**

Why didn't my air bag go off in a collision? (Inflation and non-inflation conditions of the air bag)

There are many types of accidents in which the air bag would not be expected to provide additional protection.

These include rear impacts, side impacts, rollover, second or third collisions in multiple impact accidents, as well as low speed impacts.

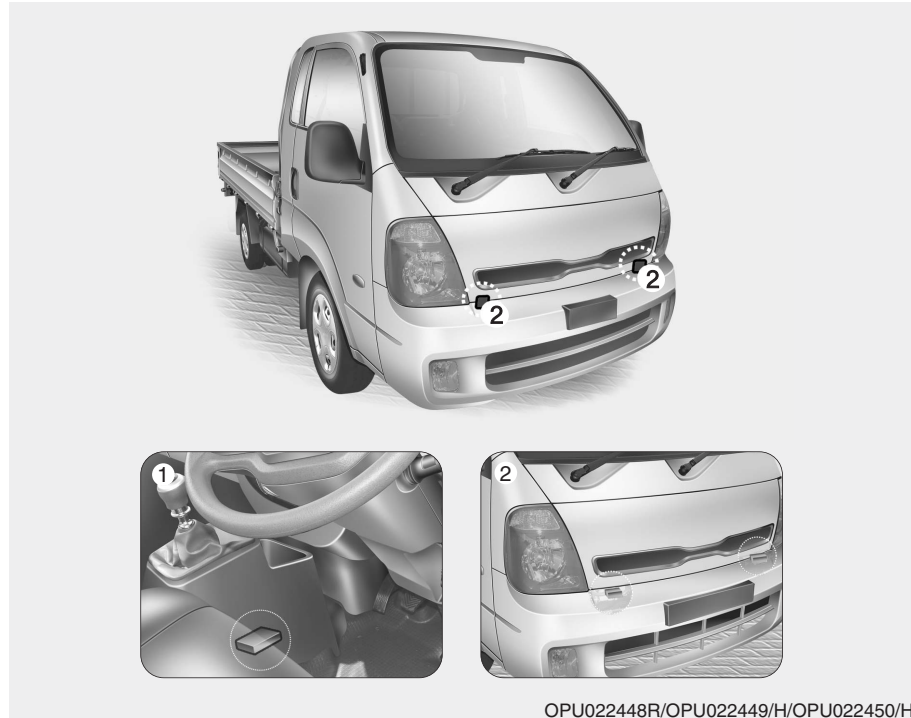

OPU022448R/OPU022449/H/OPU022450/H

Air bag collision sensors

- (1) SRS control module
- (2) Front impact sensor

1

2

3

4

5

6

7

8

9

⚠ WARNING

- Do not hit or allow any objects to impact the locations where air bag or sensors are installed. This may cause unexpected air bag deployment, which could result in serious personal injury or death.

- If the installation location or angle of the sensors is altered in any way, the air bag may deploy when they should not or they may not deploy when they should, causing severe injury or death.

Therefore, do not try to perform maintenance on or around the air bag sensors. We recommend that the system be checked and repaired by an authorised Kia dealer.

(Continued)

(Continued)

- Problems may arise if the sensor installation angles are changed due to the deformation of the front bumper or body. We recommend that the system be checked and repaired by an authorised Kia dealer.
- Your vehicle has been designed to absorb impact and deploy the air bag in certain collisions. Installing aftermarket bumper guards or replacing a bumper with non-genuine parts may adversely affect your vehicles collision and air bag deployment performance.

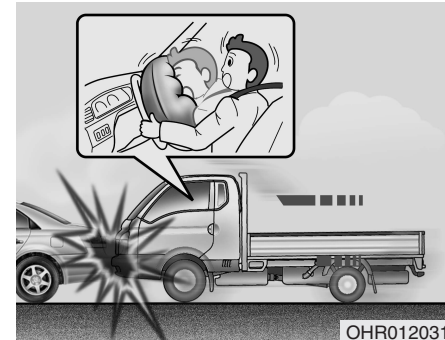

Air bag inflation conditions

Front air bag is designed to inflate in a frontal collision depending on the intensity, speed or angles of impact of the front collision.

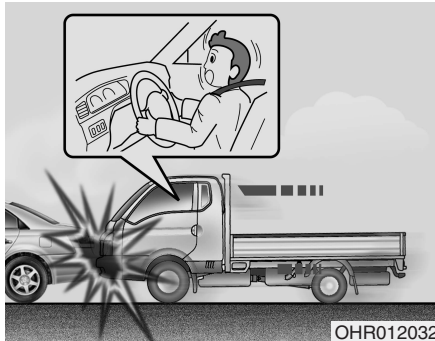

Air bag non-inflation conditions

- In certain low-speed collisions the air bag may not deploy. The air bag is designed not to deploy in such cases because they may not provide benefits beyond the protection of the seat belts in such collisions.



- Air bag is not designed to inflate in rear collisions, because occupants are moved backward by the force of the impact. In this case, inflated air bag would not be able to provide any additional benefit.

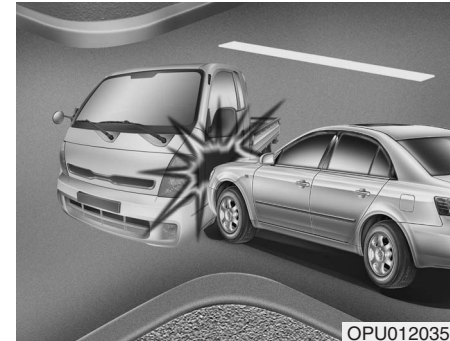

- Front air bag may not inflate in side impact collisions, because occupants move to the direction of the collision, and thus in side impacts, frontal air bag deployment would not provide additional occupant protection.

1
2
3
4
5
6
7
8
9

1

2

3

4

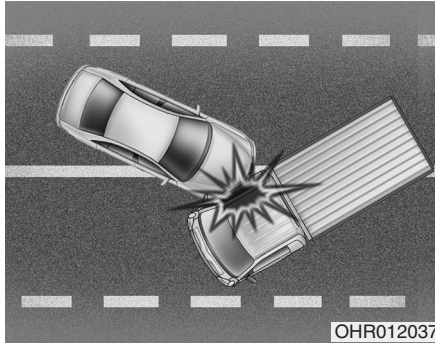

- In a slant or angled collision, the force of impact may direct the occupants in a direction where the air bag would not be able to provide any additional benefit, and thus the sensors may not deploy any air bag.

5

6

7

8

9

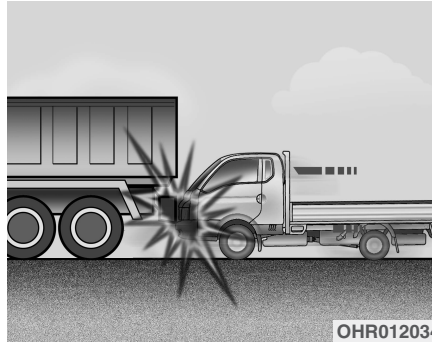

- Just before impact, drivers often brake heavily. Such heavy braking lowers the front portion of the vehicle causing it to “ride” under a vehicle with a higher ground clearance. Air bag may not inflate in this “under-ride” situation because deceleration forces that are detected by sensors may be significantly reduced by such “under-ride” collisions.

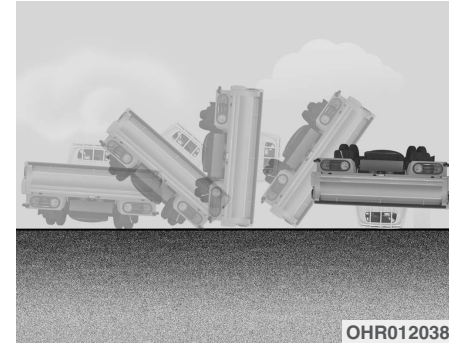

- Airbag do not inflate in most rollover accidents.

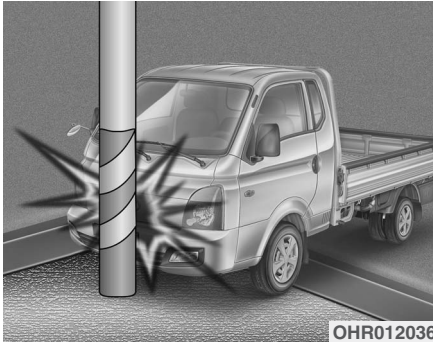

OHR012036

- Air bag may not inflate if the vehicle collides with objects such as utility poles or trees, where the point of impact is concentrated to one area and the full force of the impact is not delivered to the sensors.

SRS Care

The SRS is virtually maintenance-free and so there are no parts you can safely service by yourself. If the SRS air bag warning light does not illuminate when you turn the ignition ON, or if it continuously remains on, we recommend that the system be inspected by an authorised Kia dealer.

Improper handling of the SRS system may result in serious personal injury.

⚠ WARNING

- **Modification to SRS components or wiring, including the addition of any kind of badges to the pad covers or modifications to the body structure, can adversely affect SRS performance and lead to possible injury.**
- **For cleaning the air bag pad covers, use only a soft, dry cloth or one which has been moistened with plain water. Solvents or cleaners could adversely affect the air bag covers and proper deployment of the system.**
- **No objects should be placed over or near the air bag modules on the steering wheel, instrument panel, and the front passenger's panel above the glove box, because any such object could cause harm if the vehicle is in a crash severe enough to cause the air bag to inflate.**

(Continued)

1

2

3

4

5

6

7

8

9

1

2

3

4

5

6

7

8

9

(Continued)

- If the air bags inflate, we recommend that the system be replaced by an authorised Kia dealer.
- Do not tamper with or disconnect SRS wiring, or other components of the SRS system. Doing so could result in injury, due to accidental inflation of the air bag or by rendering the SRS inoperative.
- If components of the air bag system must be discarded, or if the vehicle must be scrapped, certain safety precautions must be observed. An authorised Kia dealer knows these precautions and can give you the necessary information. Failure to follow these precautions and procedures could increase the risk of personal injury.
- If your car was flooded and has soaked carpeting or water on the flooring, you shouldn't try to start the engine; we recommend that you contact an authorised Kia dealer.

WARNING

- Sitting improperly or out of position can cause occupants to be shifted too close to a deploying air bag, strike the interior structure or be thrown from the vehicle resulting in serious injury or death.
- Always sit upright with the seatback in an upright position, centred on the seat cushion with your seat belt on, legs comfortably extended and your feet on the floor.

Adding equipment to or modifying your air bag-equipped vehicle

If you modify your vehicle by changing your vehicle's frame, bumper system, front end or side sheet metal or ride height, this may affect the operation of your vehicle's air bag system.

BONNET

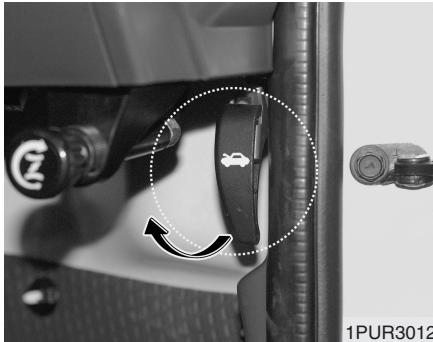

Opening the bonnet:

1. Pull the release lever on the lower right side of the instrument panel to unlatch the bonnet. The bonnet should pop open slightly.



2. Go to the front of the vehicle, raise the bonnet slightly, pull the secondary latch inside of the bonnet centre and lift the bonnet.
3. Lift the bonnet and hold it open with the support rod by inserting the free end of the rod into the slot.

Closing the bonnet

1. Before closing the bonnet, check the following:
 - All filler caps in the under bonnet area must be correctly installed.
 - Jack must be secured in its retainer to prevent it from rattling.
 2. Secure the support rod in its clip.
 3. Lower the bonnet to about 30 cm (12 inches) height and then let it drop to properly lock in place.
- Make sure the bonnet is properly locked before driving.

1
2
3
4
5
6
7
8
9

REAR GATE

1

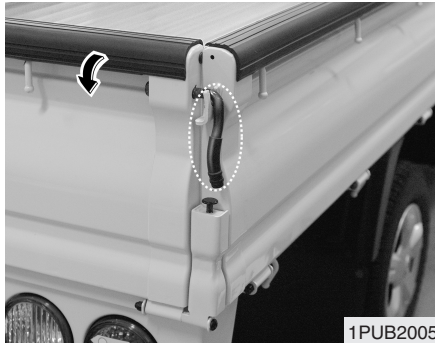

2

3

4

Opening the rear gate

1. Lift up the rear gate handle, push it inside and pull it toward you.
2. Lower the rear gate slowly with it received on both arms.

5

6

7

⚠ WARNING

When the rear combination lamps are hidden, other road users should be warned by means of warning triangle or other devices.

8

9



Closing the rear gate

Lift the rear gate up and lock the rear gate handle in place.

Make sure the rear gate is properly locked before driving.

⚠ WARNING

- Do not open the rear gate, whilst the vehicle is in motion.
- Fasten rope into the rope hook securely not to loosen the rope whilst the vehicle is in motion.

SIDE GATE



Opening the side gate

1. With the rear gate opened, pull up the knob to release the support bar down.

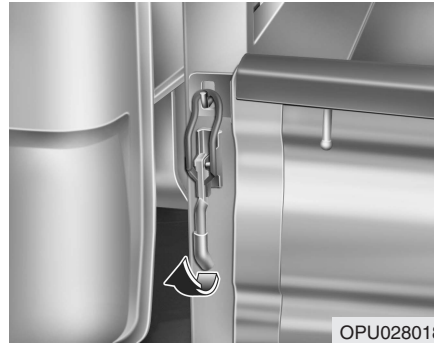

2. Remove the side gate handle from the hook after pulling it up.
3. Lower the side gate slowly with it received on both arms.

Closing the side gate

1. Lift the side gate up and lock the side gate handle in place.
2. Push the knob down to lock the side gates.

⚠ WARNING

When locking the side gate handle, be careful not to get your fingers into the chink in the handle.

1

2

3

4

5

6

7

8

9

FUEL FILLER

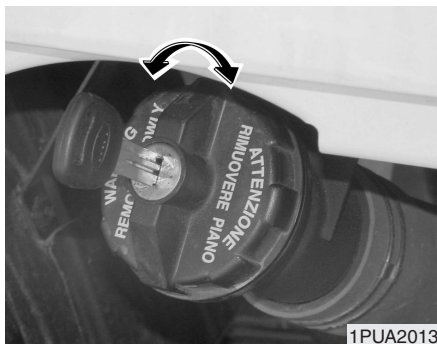

⚠ WARNING - Refuelling

- If pressurized fuel sprays out, it can cause serious injuries. Always remove the fuel cap carefully and slowly. If the cap is venting fuel or if you hear a hissing sound, wait until the condition stops before completely removing the cap.
- Fuel vapour is very hazardous and can explode. When refuelling, always stop the engine. Never allow sparks or open flames near the filler neck. Always put out cigarettes and other smoking materials before refuelling.

*** NOTICE**

- Make sure to refuel with diesel fuel only for the diesel engine vehicles.
- Check to make sure the fuel filler cap is securely closed after refuelling.
- If the fuel filler cap requires replacement, use only a genuine Kia cap or the equivalent specified for your vehicle. An incorrect fuel filler cap can result in a serious malfunction of the fuel system or emission control system. We recommend that caps be replaced by an authorised Kia dealer.
- Do not spill fuel on the exterior surfaces of the vehicle. Any type of fuel spilled on painted surfaces may damage the paint.

1

2

3

4

5

6

7

8

9

1. Stop the engine.

2. Insert the key and turn the key counterclockwise (if equipped).

3. To remove the cap, turn the fuel tank cap counterclockwise.

4. Refuel as needed.

5. To install the cap, turn it clockwise until it “clicks”. This indicates that the cap is securely tightened.

MIRRORS

Outside rearview mirror

Be sure to adjust mirror angles before driving.

Your vehicle is equipped with both left-hand and right-hand outside rearview mirrors. The mirror heads can be folded back to prevent damage during an automatic car wash or when passing in a narrow street.

CAUTION

- *The outside rearview mirror is convex. Objects seen in the mirror are closer than they appear.*
- *Use your interior rearview mirror or direct observation to determine the actual distance of following vehicles when changing lanes.*

*** NOTICE**

Do not scrape ice off the mirror face; this may damage the surface of the glass. If ice should restrict movement of the mirror, do not force the mirror for adjustment. To remove ice, use a deicer spray, or a sponge or soft cloth with very warm water.



Manual remote control

To adjust an outside mirror, move the mirror.

1

2

3

4

5

6

7

8

9

1

2

3

4



Folding the outside rearview mirror

To fold outside rearview mirror, grasp the housing of mirror and then fold it toward the rear of the vehicle.

5

6

7

8

9

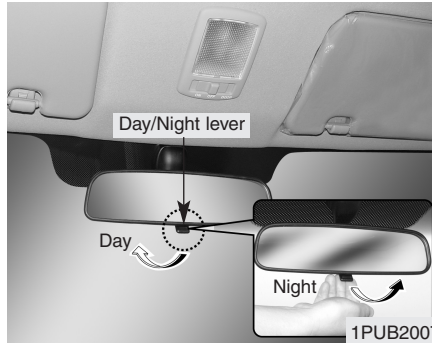

Day/Night rearview mirror (if equipped)

Make this adjustment before you start driving and whilst the day/night lever is in the day position.

Pull the day/night lever toward you to reduce glare from the headlights of vehicles behind you during night driving.

Remember that you lose some rearview clarity in the night position.

INTERIOR LIGHTS

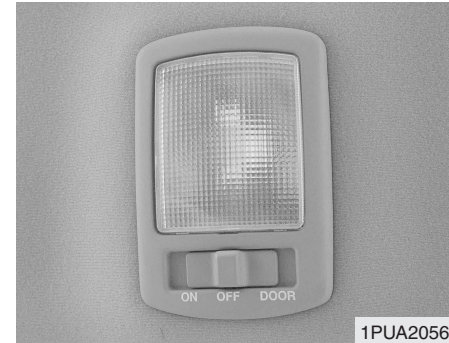

- ① ON - The light turns on and stays on even when the doors are all closed.
- ② OFF - The light stays off even when a door is open.
- ③ DOOR - The light turns on or off when a door is opened or closed.

STORAGE COMPARTMENT

These compartments can be used to store small items required by the driver or passengers.

* NOTICE

- To avoid possible theft, do not leave valuables in the storage compartment.
- Since stored items may move whilst driving, be sure to position them in the storage compartment so that they do not make noise or cause a potential safety hazard when the vehicle is moving.

⚠ WARNING

Do not store cigarette lighters, propane cylinders, or other flammable/explosive materials in the vehicle. These items may catch fire and/or explode if the vehicle is exposed to hot temperatures for extended periods.

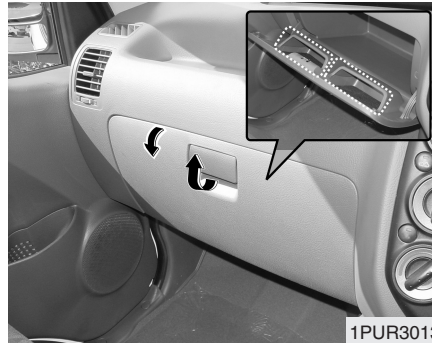

Glove box

To open the glove box, pull the handle and the glove box will automatically open. Close the glove box after use.

For your convenience, a tissue holder is located in the glove box cover.

⚠ CAUTION

To reduce the risk of injury in case of an accident or sudden stop, always keep the glove box door closed whilst driving.

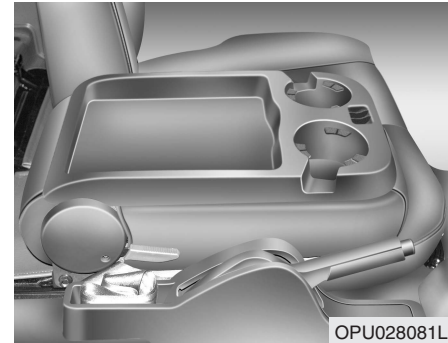

Centre seatback console tray (if equipped)

The tray is used for storing cassette tapes or small articles.

1

2

3

4

5

6

7

8

9

INTERIOR FEATURES

1

2

3

4



Cigarette lighter

To operate the cigarette lighter, press it in and release it. When it is heated, it automatically pops out ready for use.

If the engine is not running, the ignition switch must be in the ACC position for the lighter to operate.

* NOTICE

- Do not hold the lighter in after it is already heated because it will overheat.
- Only a genuine Kia lighter should be used in the cigarette lighter socket. The use of plug-in accessories (shavers, hand-held vacuums, and coffee pots, for example) may damage the socket or cause electrical failure.
- If the lighter does not pop out within 30 seconds, remove it to prevent overheating.

⚠ WARNING

Never attempt to adjust the cigar lighter whilst the vehicle is moving. This could result in loss of control, and an accident causing death, serious injury, or property damage.

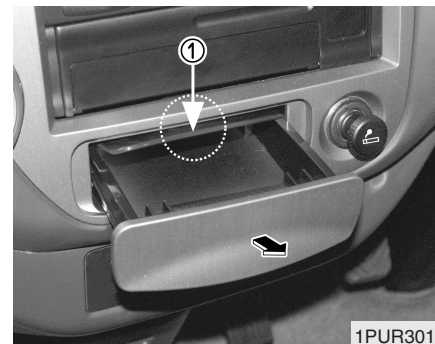

Ashtrays

To remove the ashtray to empty or clean, push the tab (①) and pull it all the way out.

⚠ WARNING - Ashtray use

- Do not use the vehicle's ashtrays as waste receptacles.
- Putting lit cigarettes or matches in an ashtray with other combustible materials may cause a fire.
- Do not insert foreign objects into the socket of the cigarette lighter. It may damage the cigarette lighter.

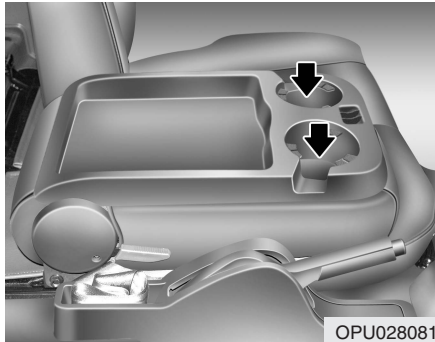

Cup holder

The cup holder is used for holding cups and cans.

⚠ WARNING - Hot liquids

- Do not place uncovered cups of hot liquid in the cup holder whilst the vehicle is in motion. If the hot liquid spills, you could be burned. Such a burn to the driver could cause a loss of control of the vehicle.
- To reduce the risk of personal injury in the event of sudden stop or collision, do not place uncovered or insecure bottles, glasses, cans, etc., in the cup holder whilst the vehicle is in motion.

*** NOTICE**

Do not place heavy cups or cans in cup holder. Cup holder could be damaged.

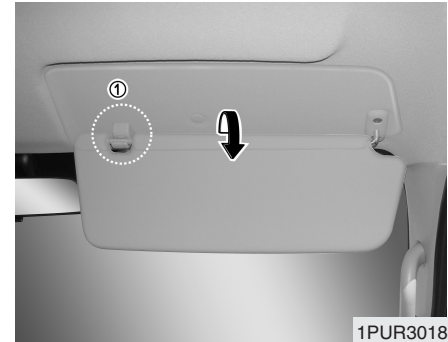

Sunvisor

Use the sunvisor to shield direct light through the front or side windows.

To use a sunvisor, pull it downward.

To use a sunvisor for a side window, pull it downward, unsnap it from the bracket (①) and swing it to the side.

1
2
3
4
5
6
7
8
9

1



Aux, USB and iPod (if equipped)

If your vehicle has an aux and/or USB (universal serial bus) port or iPod port, you can use an aux port to connect audio devices and an USB port to plug in an USB and also an iPod port to plug in an iPod.

* NOTICE

When using a portable audio device connected to the power outlet, noise may occur during playback. If this happens, use the power source of the portable audio device.

* iPod® is a trademark of Apple Inc.

2

3

4

5

6

7

8

9

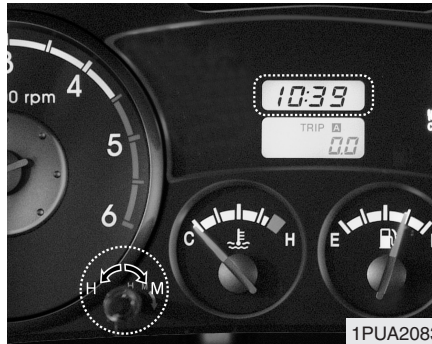

Digital clock

Whenever the battery terminals, or memory fuse are disconnected, you must reset the time.

When the ignition switch is in the ON position, the clock buttons operate as follows:

⚠ WARNING

Never attempt to adjust the digital clock whilst the vehicle is moving. This could result in loss of control, and an accident causing death, serious injury, or property damage.

- **HOUR:**

Turn the knob to the left (H), will advance the time displayed by one hour.

- **MINUTE:**

Turn the knob to the right (M), will advance the time displayed by one minute.

- **RESET:**

To clear away minutes, press the knob with your finger. Then the clock will be set precisely on the hour.

For example, if the knob is pressed whilst the time is between 9:01 and 9:29, the display will be reset to 9:00.

9:01~9:29 ⇒ 9:00

9:30~9:59 ⇒ 10:00

- *** NOTICE**

Do not turn the knob excessively to prevent knob damage.

AUDIO SYSTEM

* NOTICE

- If you install an after market HID head lamp, your vehicle's audio and electronic device may malfunction.
- Prevent chemicals such as perfume, cosmetic oil, sun cream, hand cleaner, and air freshener from contacting the interior parts because they may cause damage or discoloration.



Antenna

Your car uses a manual stainless steel antenna to receive both AM and FM broadcast signals. Pull up the antenna using your fingers.

* NOTICE

- If the antenna is dirty, be sure to clean it in order to avoid an operation malfunction.
- Before entering an automatic car wash or a place with a low height clearance, be sure that the antenna is fully retracted.

⚠ WARNING

Never attempt to adjust the antenna whilst the vehicle is moving. This could result in loss of control, and an accident causing death, serious injury, or property damage.

1

2

3

4

5

6

7

8

9

- 1
- 2
- 3**
- 4
- 5
- 6
- 7
- 8
- 9

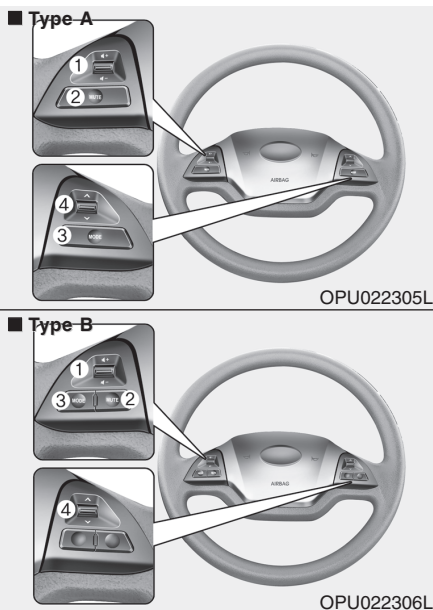

Audio remote control (if equipped)

The steering wheel audio remote control button is installed to promote safe driving.

CAUTION
Do not operate the audio remote control buttons simultaneously.

VOLUME (🔊 + / 🔊 -) (1)

- Push up the lever to increase volume.
- Push down the lever to decrease volume.

MUTE (2)

- Press the MUTE button to cancel the sound.
- Press the MUTE button again to activate the sound.

MODE (3)

Press the button to select Radio or CD (compact disc).

TRACK/SEEK UP (4)

- Radio Mode : Automatically searches for broadcast frequencies.
- CD modes :
 - Shortly press the key (under 0.8 seconds): Moves to next or previous song.
 - Press and hold the key (over 0.8 seconds): Rewinds or fast-forwards the current song.

Detailed information for audio control buttons is described in the following pages in this section.

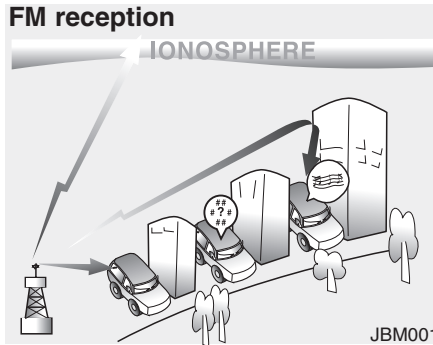

How vehicle audio works

AM and FM radio signals are broadcast from transmitter towers located around your city. They are intercepted by the radio antenna on your vehicle. This signal is then received by the radio and sent to your vehicle speakers.

When a strong radio signal has reached your vehicle, the precise engineering of your audio system ensures the best possible quality reproduction. However, in some cases the signal coming to your vehicle may not be strong and clear. This can be due to factors such as the distance from the radio station, closeness of other strong radio stations or the presence of buildings, bridges or other large obstructions in the area.

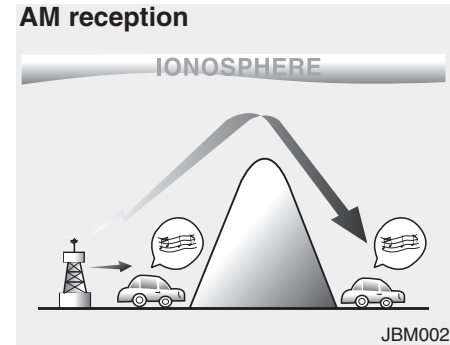

AM broadcasts can be received at greater distances than FM broadcasts. This is because AM radio waves are transmitted at low frequencies. These long, low frequency radio waves can follow the curvature of the earth rather than travelling straight out into the atmosphere. In addition, they curve around obstructions so that they can provide better signal coverage.

- 1
- 2
- 3
- 4
- 5
- 6
- 7
- 8
- 9

1

2

3

4

5

6

7

8

9

FM radio station

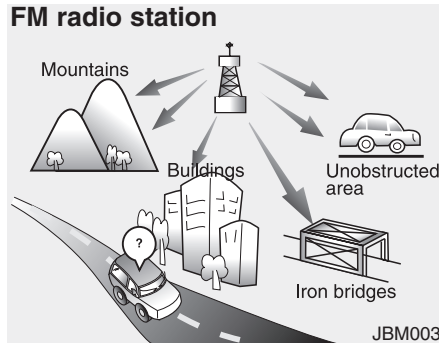

FM broadcasts are transmitted at high frequencies and do not bend to follow the earth's surface. Because of this, FM broadcasts generally begin to fade at short distances from the station.

Also, FM signals are easily affected by buildings, mountains, or other obstructions. These can result in certain listening conditions which might lead you to believe a problem exists with your radio. The following conditions are normal and do not indicate radio trouble:

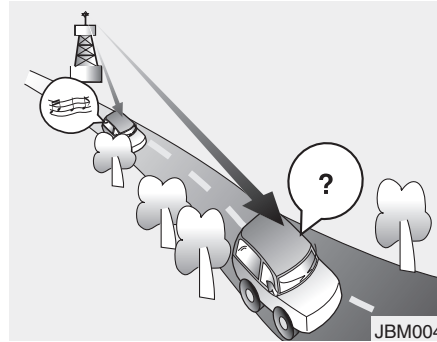

- **Fading** - As your vehicle moves away from the radio station, the signal will weaken and sound will begin to fade. When this occurs, we suggest that you select another stronger station.
- **Flutter/Static** - Weak FM signals or large obstructions between the transmitter and your radio can disturb the signal causing static or fluttering noises to occur. Reducing the treble level may lessen this effect until the disturbance clears.

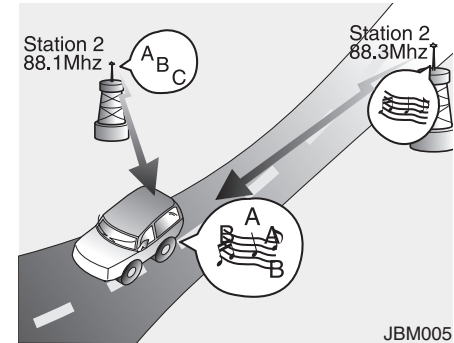

- **Station Swapping** - As a FM signal weakens, another more powerful signal near the same frequency may begin to play. This is because your radio is designed to lock onto the clearest signal. If this occurs, select another station with a stronger signal.
- **Multi-Path Cancellation** - Radio signals being received from several directions can cause distortion or fluttering. This can be caused by a direct and reflected signal from the same station, or by signals from two stations with close frequencies. If this occurs, select another station until the condition has passed.

Using a mobile phone or a two-way radio

When a mobile phone is used inside the vehicle, noise may be produced from the audio equipment. This does not mean that something is wrong with the audio equipment. In such a case, use the mobile phone at a place as far as possible from the audio equipment.

CAUTION

When using a communication system such a mobile phone or a radio set inside the vehicle, a separate external antenna must be fitted. When a mobile phone or a radio set is used with an internal antenna alone, it may interfere with the vehicle's electrical system and adversely affect safe operation of the vehicle.

WARNING

Don't use a mobile phone when you are driving. You should stop at a safe place to use a mobile phone.

Care of disc

- If the temperature inside the car is too high, open the car windows to ventilate before using the system.
- It is illegal to copy and use MP3/WMA files without permission. Use CDs that are created only by lawful means.
- Do not apply volatile agents, such as benzene and thinner, normal cleaners and magnetic sprays made for analogue disc onto CDs.
- To prevent the disc surface from getting damaged, hold CDs by the edges or the centre hole only.
- Clean the disc surface with a piece of soft cloth before playback (wipe it from the centre to the outside edge).
- Do not damage the disc surface or attach pieces of sticky tape or paper.
- Make certain only CDs are inserted into the CD player (Do not insert more than one CD at a time).
- Keep CDs in their cases after use to protect them from scratches or dirt.

- Depending on the type of CD-R/CD-RW CDs, certain CDs may not operate normally according to manufacturing companies or making and recording methods. In such circumstances, continued use may cause malfunctions to your audio system.

*** NOTICE - Playing an Incompatible Copy Protected Audio CD**

Some copy protected CDs, which do not comply with international audio CD standards (Red Book), may not play on your car audio. Please note that inability to properly play a copy protected CD may indicate that the CD is defective, not the CD player.

1
2
3
4
5
6
7
8
9

1

2

3

4

5

6

7

8

9

■ CD Player : AM110HDD(GENERAL)



PU_GEN_RADIO



Using RADIO, SETUP, VOLUME and AUDIO CONTROL

1. **FM** Button

Turns to FM mode and toggles FM1 and FM2 when the button is pressed each time.

2. **AM** Button

Pressing the **AM** button selects the AM band. AM Mode is displayed on the LCD.

3. **POWER** Button & **VOLUME** Knob

Turns on/off the set when the IGNITION SWITCH is on ACC or ON. If the button is turned to the right, it increases the volume and left, decreases the volume.

- Adjusts the volume of the car audio system. Rotate clockwise to increase the volume or counter-clockwise to decrease.



4. **SCAN** Button

- When the button is pressed, it automatically scans the radio stations upwards.
- The SCAN feature steps through each station, starting from the initial station, for 5 seconds.
- Press the **SCAN** button again to stop the scan feature and to listen to the currently selected channel.

5. **AST** Button(AUTO STORE)

When the button is pressed, it automatically selects and saves channels with high reception rate to PRESET buttons **1** ~ **6** and plays the channel saved in PRESET1. If no channel is saved after AST, it will play the previous channel.

6. **SEEK** Button

- When the **SEEK TRACK**  button is pressed, it increases the band frequency to automatically select channel. Stops at the previous frequency if no channel is found.
- When the **SEEK TRACK**  button is pressed, it reduces the band frequency to automatically select channel. Stops at the previous frequency if no channel is found.

7. PRESET Buttons



Push **1** ~ **6** buttons less than 0.8 second to play the channel saved in each button. Push Preset button for 0.8 second or longer to save current channel to the respective button with a beep.



8. **SETUP** Button

Press this button to turn to the SETUP adjustment mode.



If no action is taken for 5 seconds after pressing the button, it will return to the play mode. (After entering SETUP mode, move between items using the left, right and PUSH functions of the **TUNE** knob.)

The setup changes in the order of Scroll → Media →  → Phone

• Scroll

This function is used to display characters longer than the LCD text display and can be turned On/Off through the sound quality control knob.

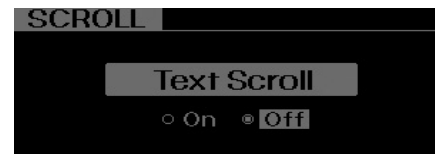

• Media

Select default display of MP3 play information. "Folder/File" or "Artist/Title" can be selected.

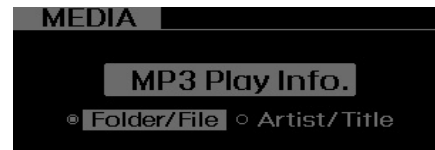

• Phone

Select this item to enter *Bluetooth*® Wireless Technology setup mode. Refer to “*Bluetooth*® Wireless Technology PHONE OPERATION” section for detailed information.



9. **AUDIO** Knob & **ENTER** Button

Turn this control whilst listening to a radio channel to manually adjust frequency.

Turn clockwise to increase frequency and counterclockwise to reduce frequency.

Pressing the button changes the BASS, MIDDLE, TREBLE and BALANCE TUNE mode. The mode selected is shown on the display. After selecting each mode, rotate the Audio control knob clockwise or counterclockwise.

BASS Control

To increase the BASS, rotate the knob clockwise, whilst to decrease the BASS, rotate the knob counterclockwise.

MIDDLE Control

To increase the MIDDLE, rotate the knob clockwise, whilst to decrease the MIDDLE, rotate the knob counterclockwise.

TREBLE Control

To increase the TREBLE, rotate the knob clockwise, whilst to decrease the TREBLE, rotate the knob counterclockwise.

BALANCE Control

Rotate the knob clockwise to emphasize right speaker sound(left speaker sound will be attenuated).

When the control knob is turned counter clockwise, left speaker sound will be emphasized(right speaker sound will be attenuated).



1

2

3

4

5

6

7

8

9



Using CD Player

1. **CD** Button (CD)

If the CD is loaded, turns to CD mode.

2. **SCAN** Button

Play each song in the CD for 10 seconds. To cancel SCAN Play, press this button again.

3. **TRACK** Button

- Press **SEEK TRACK** button for less than 0.8 seconds to play from the beginning of current song.
- Press **SEEK TRACK** button for less than 0.8 seconds and press again within 1 second to play the previous song.
- Press **SEEK TRACK** button for 0.8 seconds or longer to initiate reverse direction high speed sound search of current song.
- Press **SEEK TRACK** button for less than 0.8 seconds to play the next song.
- Press **SEEK TRACK** button for 0.8 seconds or longer to initiate forward direction high speed sound search of current song.

4. **1** Button (RANDOM)

Press this button for less than 0.8 seconds to activate 'RDM' mode and more than 0.8 seconds to activate 'ALL RDM' mode.

- RDM : Only files/tracks in a folder/disc are played back in a random sequence.
- ALL RDM (MP3/WMA Only) : All files in a disc are played back in the random sequence.

5. **2** Button (REPEAT)

Press this button for less than 0.8 seconds to activate 'RPT' mode and more than 0.8 seconds to activate 'FLD.RPT' mode.

- RPT : Only a track (file) is repeatedly played back.
- FLD.RPT (MP3/WMA Only) : Only files in a folder are repeatedly played back.



6. **▲** Button (CD Eject)

Push **▲** button for less than 0.8 seconds to eject the CD during CD playback. This button is enabled when ignition switch is off.

7. CD Slot

Insert a CD label side up and gently push in whilst ignition switch is on ACC or ON. The audio automatically switches to CD mode and begins to play the CD.

If the audio was turned off, audio power will automatically turned on as the CD is inserted.

- This audio only recognizes 12cm-size, CD-DA (Audio CD) or ISO data-CD (MP3 CD).
- If UDF data-CD or non-CD (e.g. DVD) is inserted, "Reading Error" message will be displayed and the disc will be ejected.

CAUTION

Do not insert a CD if CD indicator is lit.



9. **INFO** Button

Displays the information of the current song.

- Audio CD : Disc Title/Artist, Track Title /Artist, Total Track.
- MP3 CD : File Name, Title, Artist, Album, Folder, Total Files (Not displayed if the information is unavailable on the CD or file.)

10. **FOLDER** Button

- Press **∨FOLDER** button to move to child folder of the current folder and display the first song in the folder.
- Press **TUNE** knob to move to the folder displayed. It will play the first song in the folder.
- Press **FOLDER ^** button to move to parent folder of the current folder and display the first song in the folder.
Press **TUNE** knob to move to the folder displayed.

11. **TUNE** Knob & **ENTER** Button

- Turn this knob clockwise to browse songs after current song, or counterclockwise to browse songs before current song. To play the displayed song, press the knob.
- Pressing this knob without turning enters to AUDIO CONTROL mode.





Using USB device

1. **AUX** Button (USB)

If USB is connected, it switches to the USB mode from the other mode to play the song files stored in the USB.

If no auxiliary device is not connected, displays “No Media” for 3 seconds and return to the previous mode.

2. **SCAN** Button

Plays each song in the USB device for 10 seconds. To cancel SCAN Play, press this button again.

3. **TRACK** Button

- Press the **SEEK TRACK** button for less than 0.8 seconds to play from the beginning of the current song.

- Press the button for less than 0.8 seconds and press it again within 1 second to move to and play the previous song.

Press the button for 0.8 seconds or longer to play the song in reverse direction in fast speed.

- Press the **SEEK TRACK** button for less than 0.8 seconds to move to the next song. Press the button for 0.8 seconds or longer to play the song in forward direction in fast speed.

4. **1** Button (RANDOM)

- Press this button for less than 0.8 seconds to play songs randomly in current folder.

- Press this button for 0.8 seconds or longer to play songs randomly in entire USB device.

- To cancel RANDOM play, press this button again.

5. **2** Button (REPEAT)

- Press this button for less than 0.8 seconds to repeat current song.

- Press this button for 0.8 seconds or longer to repeat all songs in current folder.

- To cancel REPEAT, press this button again.



6. **INFO** Button

Displays the information of the file currently played in the order of FILE NAME, TITLE, ARTIST, ALBUM, FOLDER, TOTAL FILE, NORMAL DISPLAY (Displays no information if the file has no song information.)



7. **FOLDER** Button

- Press **∨ FOLDER** button to move to child folder of the current folder and display the first song in the folder. Press **TUNE** knob to move to the folder displayed. It will play the first song in the folder.
- Press **FOLDER ^** button to move to parent folder display the first song in the folder. Press **TUNE** knob to move to the folder displayed.

8. **TUNE** Knob & **ENTER** Button

- Turn this knob clockwise to browse songs after current song, or counter clockwise to browse songs before current song. To play the displayed song, press the knob.
- Pressing this knob without turning enters to AUDIO CONTROL mode.



USING YOUR USB DEVICE

1

• To use an external USB device, make sure the device is not connected when starting up the vehicle. Connect the device after starting up.

2

3

• If you start the engine when the USB device is connected, it may damage the USB device. (USB flashdrives are very sensitive to electric shock.)

4

5

• If the engine is started up or turned off whilst the external USB device is connected, the external USB device may not work.

6

7

• It may not play inauthentic MP3 or WMA files.

8

9

1) It can only play MP3 files with the compression rate between 8Kbps~320Kbps.

2) It can only play WMA music files with the compression rate between 8Kbps~320Kbps.

• Take precautions for static electricity when connecting or disconnecting the external USB device.

- An encrypted MP3 PLAYER is not recognizable.
- Depending on the condition of the external USB device, the connected external USB device can be unrecognizable.
- When the formatted byte/sector setting of External USB device is not either 512BYTE or 2048BYTE, then the device will not be recognized.
- Use only a USB device formatted to FAT 12/16/32.
- USB devices without USB I/F authentication may not be recognizable.
- Make sure the USB connection terminal does not come in contact with the human body or other objects.
- If you repeatedly connect or disconnect the USB device in a short period of time, it may break the device.
- You may hear a strange noise when connecting or disconnecting a USB device.
- If you disconnect the external USB device during playback in USB mode, the external USB device can be damaged or may malfunction. Therefore, disconnect the external USB device when the audio is turned off or in another mode. (e.g, Radio or CD)
- Depending on the type and capacity of the external USB device or the type of the files stored in the device, there is a difference in the time taken for recognition of the device.
- Do not use the USB device for purposes other than playing music files.
- Playing videos through the USB is not supported.
- Use of USB accessories such as rechargers or heaters using USB I/F may lower performance or cause trouble.
- If you use devices such as a USB hub purchased separately, the vehicle's audio system may not recognize the USB device. In that case, connect the USB device directly to the multimedia terminal of the vehicle.

(Continued)

(Continued)

- If the USB device is divided by logical drives, only the music files on the highest-priority drive are recognized by car audio.
- Devices such as MP3 Player/ Mobile phone/Digital camera can be unrecognizable by standard USB I/F can be unrecognizable.
- Charging through the USB may not be supported in some mobile devices.

*** A car exclusive cable (Provided or sold separately) is required to use the iPod.**

- Some non-standard USB devices (METAL COVER TYPE USB) can be unrecognizable.
- Some USB flash memory readers (such as CF, SD, microSD, etc.) or external-HDD type devices can be unrecognizable.
- Music files protected by DRM (DIGITAL RIGHTS MANAGEMENT) are not recognizable.

- The data in the USB memory may be lost whilst using this audio. Always back up important data on a personal storage device.
- Please avoid using USB memory products which can be used as key chains or mobile phone accessories as they could cause damage to the USB jack. Please make certain only to use plug type connector products as shown below.



*** NOTICE - Playing an Incompatible Copy Protected Audio CD**

Some copy protected CDs, which do not comply with international audio CD standards (Red Book), may not play on your car audio. Please note that inability to properly play a copy protected CD may indicate that the CD is defective, not the CD player.

NOTE:

Order of playing files (folders) :

1. Song playing order : ① to ⑩

2. Folder playing order :

*** If no song file is contained in the folder, that folder is not displayed.**

1
2
3
4
5
6
7
8
9

Knowing your vehicle

1

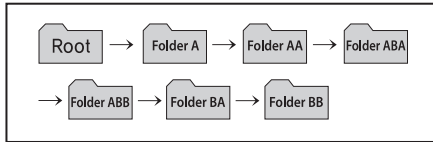

2

3

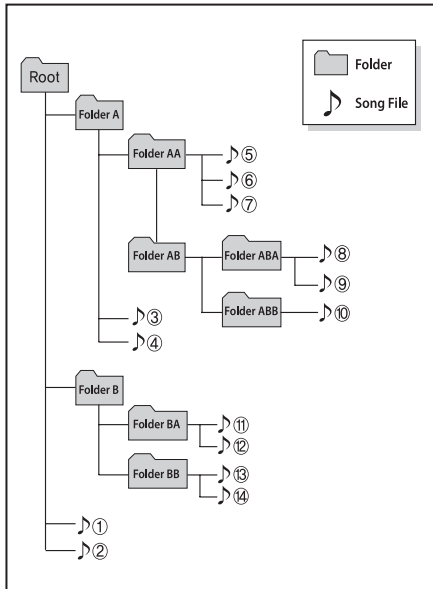

4

5

6

7

8

9



Using iPod

* iPod is a trademark of Apple Inc.

1. **AUX** Button (iPod)

If iPod is connected, it switches to iPod mode to play the song files stored in iPod. If no auxiliary device is not connected, it displays “No Media” for 3 seconds and returns to the previous mode.

2. **SCAN** Button

Plays each song in the USB device for 10 seconds.

To cancel SCAN Play, press this button again.

3. **TRACK** Button

• Press the **SEEK TRACK** button for less than 0.8 seconds to play from the beginning of the song currently played.

Press the button for less than 0.8 seconds and press it again within 1 second to move to and play the previous track.

Press the button for 0.8 seconds or longer to play the song in reverse direction in fast speed.

• Press the **SEEK TRACK** button for less than 0.8 seconds to move to the next track.

Press the button for 0.8 seconds or longer to play the song in forward direction in fast speed.

4. **1** Button (RANDOM)

• Press this button for less than 0.8 seconds to shuffle order of all songs in current category. (Song Random)

• Press this button for 0.8 seconds or longer to shuffle order of albums in current category. (Album Random)

• To cancel RANDOM Play, press this button again.

5. **2** Button (REPEAT)

Repeats the song currently played.

1

2

3

4

5

6

7

8

9

1

2

3



6. **INFO** Button

Displays the information of the file currently played in the order of TITLE, ARTIST, ALBUM, NORMAL DISPLAY (Displays no information if the file has no song information.)

7. **6** Button (MENU)

Moves to the upper category from currently played category of the iPod. To move to (play) the category (song) displayed, press **TUNE** knob. You will be able to search through the lower category of the selected category.

The standard order of iPod's category is Playlist, Artist, Albums, Genes, Songs, Compersers.



8. **TUNE** Knob & **ENTER** Button

When you rotate the knob clockwise, it will display the songs (category) ahead of the song currently played (category in the same level).

Also, when you rotate the knob counterclockwise, it will display the songs (category) before the song currently played (category in the same level).

To listen to the song displayed in the song category, press the button to skip to and play the selected song.

Pressing the button changes the BASS, MIDDLE, TREBLE and BALANCE TUNE mode. The mode selected is shown on the display. After selecting each mode, rotate the Audio control knob clockwise or counterclockwise.

- Some iPod models may not support communication protocol and files may not properly play.

Supported iPod models:

- iPod Mini®
- iPod 4th(Photo) ~ 6th(Classic) generation
- iPod Nano® 1st~4th generation
- iPod Touch® 1st~2nd generation
- The order of search or playback of songs in the iPod can be different from the order searched in the audio system.
- If the iPod disabled due to its own malfunction, reset the iPod. (Reset: Refer to iPod manual)
- An iPod may not operate normally on low battery.

- Some iPod devices, such as the iPhone, can be connected through the -interface. The device must have audio *Bluetooth®* Wireless Technology capability (such as for stereo headphone *Bluetooth®* Wireless Technology). The device can play, but it will not be controlled by the audio system.
- The Kia iPod Power Cable is needed in order to operate iPod with the audio buttons on the audio system. The USB cable provided by Apple may cause malfunction and should not be used for Kia vehicles.
* ***The Kia iPod Power Cable may be purchased through your Kia Dealership.***
- When connecting iPod with the iPod Power Cable, insert the connector to the multimedia socket completely. If not inserted completely, communications between iPod and audio may be interrupted.

- When adjusting the sound effects of the iPod and the audio system, the sound effects of both devices will overlap and might reduce or distort the quality of the sound.
- Deactivate (turn off) the equalizer function of an iPod when adjusting the audio system's volume, and turn off the equalizer of the audio system when using the equalizer of an iPod.
- When the iPod cable is connected, the system can be switched to AUX mode even without iPod device and may cause noise. Disconnect the iPod cable when you are not using the iPod device.
- When not using iPod with car audio, detach the iPod cable from iPod. Otherwise, iPod may remain in accessory mode, and may not work properly.

1

2

3

4

5

6

7

8

9

- When connecting the iPod, use the USB/AUX terminals.

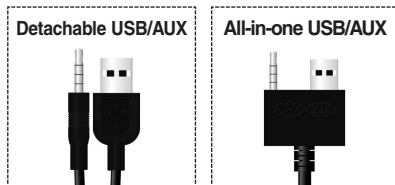

AUX

This feature is used to play external MEDIA currently connected with the AUX terminal. AUX mode will automatically start when an external device becomes connected. If an external device is already connected, you can also press the **AUX** key to change to AUX mode.



- When disconnecting the iPod, disconnect both the USB/AUX terminal.
- The iPod exclusive cable must be connected to both the USB/AUX terminals for iPod charging and operations to be supported.

* AUX mode cannot be started unless there is an external device connected to the AUX terminal.

AUX

- Fully insert the AUX cable into the AUX terminal for use.

What is *Bluetooth*® Wireless Technology?

Bluetooth® Wireless Technology that allows multiple devices to be connected in a short range, low-powered devices like hands-free, stereo headset, wireless remote controller, etc. For more information, visit the *Bluetooth*® Wireless Technology website at www.Bluetooth.com

- *Bluetooth*® Wireless Technology features can be used only when the mobile phone has been paired and connected with the device. For more information on pairing and connecting *Bluetooth*® Wireless Technology mobile phones, refer to the “Phone Setup” section.

When a *Bluetooth*® Wireless Technology mobile phone is connected, a (📶) icon will appear at the top of the screen. If a (📶) icon is not displayed, this indicates that a *Bluetooth*® Wireless Technology device has not been connected. You must connect the device before use. For more information on *Bluetooth*® Wireless Technology mobile phones, refer to the “Phone Setup” section.

Pairing and connecting a *Bluetooth*® Wireless Technology mobile phone will work only when the *Bluetooth*® Wireless Technology option within your mobile phone has been turned on. (Methods of turning on the *Bluetooth*® Wireless Technology feature may differ depending on the mobile phone.)

In some mobile phones, starting the ignition whilst talking through *Bluetooth*® Wireless Technology handsfree call will result in the call becoming disconnected. (Switch the call back to your mobile phone when starting the ignition.)

Some features may not be supported in some *Bluetooth*® Wireless Technology mobile phone and devices.

Bluetooth® Wireless Technology functions may operate unstably depending on the communication state.

- Do not use a mobile phone or perform *Bluetooth*® Wireless Technology settings (e.g. pairing a phone) whilst driving.
- Some *Bluetooth*® Wireless Technology-enabled phones may not be recognized by the system or fully compatible with the system.

(Continued)





(continued)

- 1
 - 2
 - 3
 - 4
 - 5
 - 6
 - 7
 - 8
 - 9
- Before using *Bluetooth*[®] Wireless Technology related features of the audio system, refer your phone's User's Manual for phone-side *Bluetooth*[®] Wireless Technology operations.
 - The phone must be paired to the audio system to use *Bluetooth*[®] Wireless Technology related features.
 - You will not be able to use the hands-free feature when your phone (in the car) is outside of the mobile service area (e.g. in a tunnel, in a underground, in a mountainous area, etc.).
 - If the mobile phone signal is poor or the vehicles interior noise is too loud, it may be difficult to hear the other person's voice during a call.
 - Do not place the phone near or inside metallic objects, otherwise communications with *Bluetooth*[®] Wireless Technology system or mobile service stations can be disturbed.

- Whilst a phone is connected through *Bluetooth*[®] Wireless Technology your phone may discharge quicker than usual for additional *Bluetooth*[®] Wireless Technology-related operations.
- Some mobile phones or other devices may cause interference noise or malfunction to audio system. In this case, store the device in a different location may resolve the situation.
- Please save your phone name in English, or your phone name may not be displayed correctly.
- If Priority is set upon vehicle ignition(IGN/ACC ON), the *Bluetooth*[®] Wireless Technology phone will be automatically connected. Even if you are outside, the *Bluetooth*[®] Wireless Technology phone will be automatically connected once you are in the vicinity of the vehicle.
- If you do not want automatic *Bluetooth*[®] Wireless Technology power off.

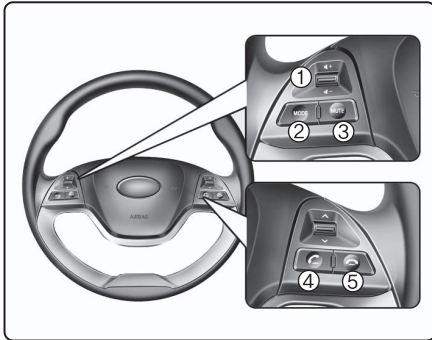
**Bluetooth® Wireless Technology
PHONE OPERATION**



1. **VOLUME** button : Raises or lowers speaker volume.
2. **MODE** : Each time the mode button is pressed, the mode will convert.
3. **MUTE** : Mute the microphone during a call.
4.  button : Places and transfers calls.
5.  button : Ends calls or cancels functions.

■ **What is Bluetooth® Wireless Technology?**

Bluetooth® Wireless Technology that allows multiple devices to be connected in a short range, low-powered devices like hands-free, stereo headset, wireless remote control, etc. For more information, visit the *Bluetooth®* Wireless Technology website at www.Bluetooth.com

■ **General Features**

- This audio system supports Bluetooth® Wireless Technology hands-free and stereo-headset features.
 - HANDS-FREE feature: Making or receiving calls wirelessly.
 - STEREO-HEADSET feature: Playing music from mobile phones (that supports A2DP feature) wirelessly.

* **NOTICE**

- The phone must be paired to the system before using *Bluetooth®* Wireless Technology features.
- Only one selected (connected) mobile phone can be used with the system at a time.
- Some phones are not fully compatible with this system.
- The *Bluetooth®* Wireless Technology word mark and logos are registered trademarks owned by *Bluetooth®* Wireless Technology SIG, Inc. and any use of such marks by Kia is under license. A *Bluetooth®* Wireless Technology enabled cell phone is required to use *Bluetooth®* Wireless Technology wireless technology.

1
2
3
4
5
6
7
8
9

1

■ Phone Setup

All *Bluetooth*® Wireless Technology-related operations can be performed in PHONE menu.

2

1) Push the **SETUP** button to enter SETUP mode.

3

2) Rotate the **TUNE** knob to move the cursor between items and push the **ENTER** button to select "Phone".

4



5

6

7

3) Rotate the **TUNE** knob to move the cursor between items and push the **ENTER** button to select a desired item..

8

9



• Pairing a phone

Before using *Bluetooth*® Wireless Technology features, the phone must be paired (registered) with the audio system. Up to 5 phones can be paired with the system.

NOTE:

- **The pairing procedure of the phone varies according to each phone model. Before attempting to pair phone, please see your phone's User's Guide for instructions.**
- **Once pairing with the phone is completed, there is no need to pair with that phone again unless the phone is deleted manually from the audio system (refer "Deleting a Phone" section) or the vehicle's information is removed from the phone.**

1. Press **SETUP** button to enter SETUP mode.



2. Select "PHONE", then "Pair" in PHONE menu.
3. The audio displays "searching passkey: 0000"
4. Search the *Bluetooth*® Wireless Technology system on your phone .Your phone should display your [vehicle model name] on the *Bluetooth*® Wireless Technology device list. Then attempt pairing on your phone.

NOTE:

- If the phone is paired with two or more vehicles of the same model, some phones may not handle *Bluetooth®* Wireless Technology devices of that name correctly. In this case, you may need to change the name displayed on your phone.

For example, if the vehicles' name is BONGO, you may need to change the name displayed on you phone from KIA BONGO to JOHNS_BONGO or BONGO1 to avoid ambiguity.

Refer to your phone User's Guide, or contact your mobile carrier or phone manufacturer for instructions.

• **Connecting a phone**

When the *Bluetooth®* Wireless Technology system is enabled, the phone previously used is automatically selected and re-connected. If you want to select different phone previously paired, the phone can be selected through "Phone" menu.

Only a selected phone can be used with the hands-free system at a time.

1. Press **SETUP** button to enter SETUP mode.



2. Select "PHONE", then "Select" in PHONE menu.
3. Select desired phone name from the list shown.

• **Deleting a Phone**

The paired phone can be deleted.

- When the phone is deleted, all the information associated with that phone is also deleted (including phonebook).
- If you want to use the deleted phone with the audio system again, pairing procedure must be completed once more.

1. Press **SETUP** button to enter SETUP mode.



2. Select "PHONE", then "Delete" in PHONE menu.
3. Select desired phone name from the list shown.



• Changing Priority

If several phones are paired with the audio system, the system attempts to connect following order when the *Bluetooth*® Wireless Technology system is enabled:

- 1) “Priority” checked phone.
- 2) Previously connected phone
- 3) Gives up auto connection.

1. Press **SETUP** button to enter SETUP mode.



2. Select “PHONE”, then “Priority” in PHONE menu.
3. Select desired phone name from the list shown.

• Turning *Bluetooth*® Wireless Technology ON/OFF

Bluetooth® Wireless Technology system can be enabled (ON) or disabled (OFF) by this menu.

- If *Bluetooth*® Wireless Technology is disabled, all the commands related to *Bluetooth*® Wireless Technology system prompts whether you wish to turn *Bluetooth*® Wireless Technology ON or not.

1. Press **SETUP** button to enter SETUP mode.
2. Select “PHONE”, then “BT Off” in PHONE menu.



■ Receiving a Phone Call

When receiving a phone call, a ringtone is audible from speakers and the audio system changes into telephone mode.

When receiving a phone call, “Incoming” message and incoming phone number (if available) are displayed on the audio.

- To Answer a Call:

- Press  button on the steering wheel.

- To Reject a Call:

- Press  button on the steering wheel.

- To Adjust Ring Volume:

- Use VOLUME buttons on the steering wheel.

- To Transfer a Call to the Phone(Private Call):

- Press and hold  button on the steering wheel until the audio system transfers a call to the phone.

■ Talking on the Phone

When talking on the phone, “Active Calls” message and the other party’s phone number are displayed on the audio.

- To Mute the Microphone
- Press **MUTE** button on the steering wheel.
- To Finish a Call
- Press  button on the steering wheel.

■ Making a Phone Call

A Call Back can be made by pressing  button on the steering wheel.

- This is the same function as using the  button solely on the mobile phone.

NOTE:

Some phone models require pressing  button twice to make a call.

*** NOTICE**

In the following situations, you or the other party may have difficulty hearing each other:

1. Speaking at the same time, your voice may not reach each other parties. (This is not a malfunction.) Speak alternately with the other party on the phone.
2. Keep the *Bluetooth*® Wireless Technology volume to a low level. High-level volume may result in distortion and echo.
3. When driving on a rough road.
4. When driving at high speeds.
5. When the window is open.

6. When the air conditioning vents are facing the microphone.
7. When the sound of the air conditioning fan is loud.

■ Using the head unit as *Bluetooth*® Wireless Technology music

This audio system supports A2DP (Audio Advanced Distribution Profile) and AVRCP (Audio Video Remote Control Profile).

Both profiles are available for listening to the MP3 music via *Bluetooth*® Wireless Technology mobile phone supporting above *Bluetooth*® Wireless Technology profiles.

To play MP3 music from the *Bluetooth*® Wireless Technology mobile phone, press the **AUX** button until “MP3 Play” is displayed on the LCD.

Then try playing music by phone.

When playing music from the *Bluetooth*® Wireless Technology mobile phone, the head unit displays MP3 MODE.

1
2
3
4
5
6
7
8
9

NOTE:

1

- Not only MP3 files, all the sounds that the phone supports can be heard by the audio system.

2

- The *Bluetooth®* Wireless Technology mobile phones shall feature A2DP and AVRCP functions.

3

- Some A2DP and AVRCP *Bluetooth®* Wireless Technology mobile phones may not play music through the head unit on first try. Please try the below;

4

5

i.e : Menu→Filemanager→Music→
Option→Play via *Bluetooth®*
Wireless Technology

6

7

- Please refer to User's Guide of your phone for more.

8

To stop music, try stop playing music from the phone then change the audio mode to other than “MP3 Play” mode (e.g. FM, AM, CD, etc.)

9

■ AM100HDG



- 1
- 2
- 3**
- 4
- 5
- 6
- 7
- 8
- 9

SYSTEM CONTROLLERS AND FUNCTIONS

Audio Head Unit



1. **EJECT** (EJECT)

Ejects the disc.

2. **FM/AM**

- Changes to FM/AM mode.
- Each time the key is pressed, the mode is changed in order of FM1 → FM2 → AM

3. **CD/AUX**

Each time the key is pressed, the mode is changed in order of CD, AUX modes.

4. **Power/Volume Knob**

- Power knob : turn power on/off
- Volume knob : set volume

5. **2 REW**

Play the song in reverse direction in fast speed.

6. **3 FF**

Play the song in forward direction in fast speed.



7. **4 RDM**

Plays songs in random order.

8. **5 RPT**

Repeats the current song.

9. **SEEK** **TRACK**

- Radio Mode : Automatically searches for broadcast frequencies.
- CD modes :
 - Shortly press the key (under 0.8 seconds): Moves to next or previous song.
 - Press and hold the key (over 0.8 seconds): Rewinds or fast-forwards the current song.

10. **AST/SCAN**

- Radio mode : Files scanning or auto save radio broadcast frequencies.
- CD mode : Scans all songs for 10 seconds starting from the next song.

11.  Tune knob

- Radio mode : Changes frequency by turning the knob left/right
- CD mode: Searches songs by turning the knob left/right
- * When the desired song is displayed, press the knob to play the song.
- Moves focus in all selection menus and selects menus.





12.  ~  (Preset)

In radio mode, Saves and receives frequencies (channels).

Audio Settings

This feature is used to control the Bass, Treble, Balance.

Press  TUNE knob ▶ Select menu through  TUNE knob ▶  TUNE knob left/right to set

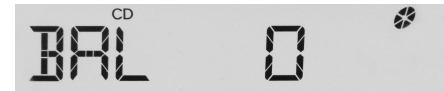
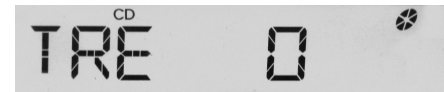
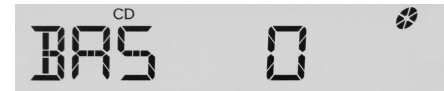

- Bass, Treble : Sets the sound values.
- Balance : Moves the sound balance.



RADIO

Changing RADIO mode



Press the **FM/AM** key to change the mode in order of FM1 → FM2 → AM.

- When the power is off, press the **FM/AM** key to turn the power on and receive radio broadcasts.

Adjust Volume

Turn the **VOL** knob left/right to adjust the volume.

SEEK

Press the **FM/AM** key ▶ **SEEK** **TRACK**

- Shortly pressing the key (under 0.8 seconds) : Automatically searches for the next frequency.
- Pressing and holding the key (over 0.8 seconds) : Automatically searches for frequencies from the moment the key is pressed and released.

Preset SEEK

Press the **FM/AM** key ▶ **1** ~ **6**

- Shortly pressing the key (under 0.8 seconds): Plays the frequency saved in the corresponding key.
- Pressing and holding the key (over 0.8 seconds): Pressing and holding the desired key from **1** ~ **6** will save the currently playing broadcast to the selected key and sound a BEEP.

AST (Auto Store)

Press the **FM/AM** key ▶ **AST/SCAN**

- Shortly pressing the key (under 0.8 seconds): The broadcast frequency increases and previews each broadcast for 5 seconds each. After scanning all frequencies, returns and plays the current broadcast frequency.
 - Pressing and holding the key (over 0.8 seconds): Previews the broadcasts saved in Preset **1** ~ **6** for 5 seconds each.
- * Press the key again to continue listening to the current frequency.

Selecting through manual search

Turn the **TUNE** knob left/right to adjust the frequency.

- FM : Changes by 100kHz
- AM : Changes by 9kHz

BASIC METHOD OF USE : AUDIO CD /AUX

Press the **CD/AUX** key to change the mod mode in order of CD→AUX.

- * The CD is automatically played when a CD is inserted.
- * If no auxiliary device is not connected, it displays “No Media” for 5 seconds and returns to the previous mode.

Repeat

Whilst song is playing ▶ **5 RPT** key
Audio CD: RPT on screen

- To repeat one song : Repeats the current song.
- * Press the **5 RPT** key again to turn off repeat.

Random

Whilst song is playing ▶ **4 RDM** key
Audio CD : RDM on screen

- Random : Plays all songs in random order.
- * Press the **4 RDM** key again to turn off repeat.

Scan

- Shortly press the key for 10 seconds each.
- * Press the **AST/SCAN** key again to continue listening to the current song.

Changing Song

Whilst song is playing ▶ **TRACK** key

- Shortly pressing the key (under 0.8 seconds): Plays the current song from the beginning.
- * If the **TRACK** key is pressed again within 1 second, the previous song is played.
- Pressing and holding the key (over 0.8 seconds): Rewinds the song.

Whilst song is playing ▶ **SEEK** key

- Shortly pressing the key (under 0.8 seconds): Plays the next song.
- Pressing and holding the key (over 0.8 seconds): Fast forwards the song.

1

2

3

4

5

6

7

8

9

1

AUX

AUX is used to play external MEDIA currently connected with the AUX terminal. AUX mode will automatically start when an external device is connected to the AUX terminal.

2

3

If an external device is connected, you can also press the **CD/AUX** key to change to AUX mode.

4



5

* AUX mode cannot be started unless there is an external device connected to the AUX terminal.

6

7

8

9

AUX

- Fully insert the AUX cable into the AUX terminal for use.

■ AM101HDG



1

2

3

4

5

6

7

8

9

SYSTEM CONTROLLERS AND FUNCTIONS



Audio Head Unit

1. **EJECT**
Ejects the disc.

2. **FM/AM**

- Changes to FM/AM mode.
- Each time the key is pressed, the mode is changed in order of FM1 → FM2 → AM

3. **MEDIA**

Each time the key is pressed, the mode is changed in order of CD, USB, iPod, AUX modes.

4. **Power/Volume Knob**

- Power knob : turn power on/off
- Volume knob: set volume

5. **SEEK TRACK**

- Radio Mode : Automatically searches for broadcast frequencies.
- CD, USB, iPod modes :
 - Shortly press the key (under 0.8 seconds): Moves to next or previous song(file).
 - Press and hold the key (over 0.8 seconds): Rewinds or fast-forwards the current song(file).

6. **1 FF**

Play the song(file) in forward direction in fast speed.

7. **4 REW**

Play the song(file) in reverse direction in fast speed.

8. **2 RPT**

Repeats the current song(file).

9. **5 RDM**

Plays songs(files) in random order.

10. **3 MENU**

In iPod mode, moves to parent folder upon category search.

11. **6 SCR**

Select whether long file names are scrolled continuously (On) or just once(Off).



12. **1 ~ 6 (Preset)**

In radio mode, Saves and receives frequencies (channels).



13. **AST CD SCAN**

- Radio mode : Files scanning or auto save radio broadcast frequencies.
- CD, USB, iPod mode : Scans all songs (files) for 10 seconds starting from the next song.

14. **INFO**

MP3 CD, USB mode : Displays the inform of the current file.

15. **TUNE knob**

- Radio mode : Changes frequency by turning the knob left/right
- CD, USB, iPod mode: Searches songs (files) by turning the knob left/right
- * When the desired song is displayed, press the knob to play the song.
- Moves focus in all selection menus and selects menus.

16. **FOLDER FOLDER**

- MP3 CD, USB mode : Folder Search
- iPod mode: Moves to parent folder.

Audio Settings

This feature is used to control the Bass, Treble, Balance.

Press **TUNE knob**▶Select menu through **TUNE knob**▶**TUNE knob** left/right to set

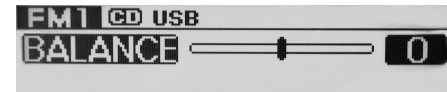

- Bass, Treble : Sets the sound values.
- Balance : Moves the sound balance.



RADIO

Changing RADIO mode

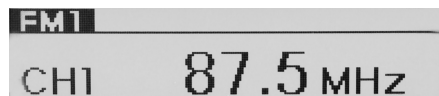

Press the **FM/AM** key to change the mode in order of FM1 → FM2 → AM.

- When the power is off, press the **FM/AM** key to turn the power on and receive radio broadcasts.

Adjust Volume

Turn the **VOL** knob left/right to adjust the volume.

SEEK

Press the **FM/AM** key ▶ **SEEK TRACK**

- Shortly pressing the key (under 0.8 seconds) : Automatically searches for the next frequency.
- Pressing and holding the key (over 0.8 seconds) : Automatically searches for frequencies from the moment the key is pressed and released.

Preset SEEK

Press the **FM/AM** key ▶ **1** ~ **6**

- Shortly pressing the key (under 0.8 seconds): Plays the frequency saved in the corresponding key.
- Pressing and holding the key (over 0.8 seconds): Pressing and holding the desired key from **1** ~ **6** will save the currently playing broadcast to the selected key and sound a BEEP.

AST (Auto Store)

Press the **FM/AM** key ▶ **AST CD SCAN**

- Shortly pressing the key (under 0.8 seconds): The broadcast frequency increases and previews each broadcast for 5 seconds each. After scanning all frequencies, returns and plays the current broadcast frequency.
- Pressing and holding the key (over 0.8 seconds): Previews the broadcasts saved in Preset **1** ~ **6** for 5 seconds each.
* Press the key again to continue listening to the current frequency.

Selecting through manual search

Turn the **TUNE** knob left/right to adjust the frequency.

- FM : Changes by 100kHz
- AM : Changes by 9kHz

BASIC METHOD OF USE : AUDIO CD / MP3 CD / USB / iPod /AUX

Press the **MEDIA** key to change the mod mode in order of CD→USB(iPod)→AUX.

- * The CD is automatically played when a CD is inserted.
- * The USB music is automatically played when a USB is connected.
- * If no auxiliary device is not connected, it displays “No Media” for 5 seconds and returns to the previous mode.

Repeat

Whilst song (file) is playing ▶ **2 RPT** key

Audio CD, MP3 CD, USB, iPod mode: RPT on screen

- To repeat one song : Shortly pressing the key (under 0.8 seconds) Repeats the current song.

MP3 CD, USB mode: on screen

- To repeat folder : Pressing and holding the key (over 0.8 seconds) repeats all files within the current folder.
- * Press the **2 RPT** key again to turn off repeat.

Random

Whilst song (file) is playing ▶ **5 RDM** key

Audio mode : RDM on screen

- Random (Shortly pressing the key (under 0.8 seconds)): Plays all songs in random order.

MP3 CD, USB mode: FLD.RDM on screen

- Folder Random : Shortly press the key (under 0.8 seconds) to play all files within the current folder in random order.

USB mode : ALB.RDM on screen

- All Random : Press and hold the key (over 0.8 seconds) to play all files in random order.

MP3 CD, USB, iPod mode :
ALB.RDM on screen

- Album Random : Shortly press the key (under 0.8 seconds) to play all songs within albums of the current category in random order.

iPod mode: A.RDM on screen

- All Random : Press and hold the key (over 0.8 seconds) to play all songs in the current category in random order.
- * Press the **5 RDM** key again to turn off repeat.

Scan

- CD, USB, iPod mode

- Shortly press the key (under 0.8 seconds): Previews each song (file) for 10 seconds each

- * Press the **AST CD SCAN** key again to continue listening to the current song (file).

1

2

3

4

5

6

7

8

9

Changing Song/File

Whilst song (file) is playing ▶  key

- Shortly pressing the key (under 0.8 seconds): Plays the current song from the beginning.

* If the  key is pressed again within 1 second, the previous song is played.

- Pressing and holding the key (over 0.8 seconds): Rewinds the song.

Whilst song (file) is playing ▶  key

- Shortly pressing the key (under 0.8 seconds): Plays the next song.
- Pressing and holding the key (over 0.8 seconds): Fast forwards the song.

Folder Search : MP3 CD / USB Mode

Whilst file is playing ▶  (Folder Up) key

Searches the parent folder of the current folder.

Whilst file is playing ▶  (Folder Down) key

Searches the sub folder of the current folder.

* If a folder is selected by pressing the  TUNE knob, the first file within the selected folder will be played.

* In iPod mode, moves to the Parent Folder.

Searching Songs (File)

Turning  TUNE knob : Searches for files

Pressing  TUNE knob : Plays selected file.

MENU : iPod Mode

Whilst file is playing ▶  key
Enters category search mode.

Moves to the next higher level list with each press of the key.

Information

Whilst file is playing ► **INFO** key
 Information on the current file is displayed in the order

MP3 CD, USB mode : FILE NAME ►
 TITLE ► ARTIST ► ALBUM ►
 FOLDER ► TOTAL FILE.

iPod mode : TITLE ► ARTIST ►
 ALBUM ► TOTAL FILE.

NOTE:

Order of playing files (folders) :

1. Song playing order : ① to ⑭

2. Folder playing order :

* If no song file is contained in the folder, that folder is not displayed.

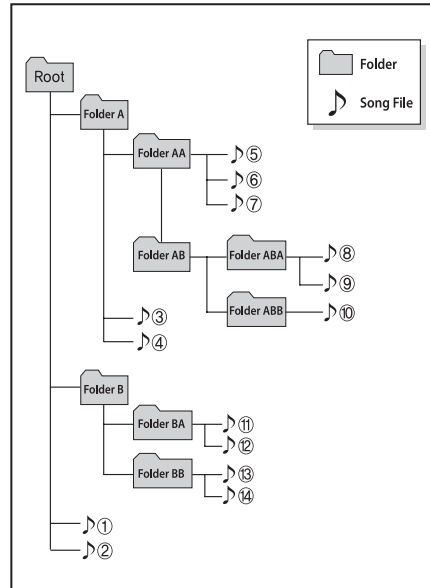
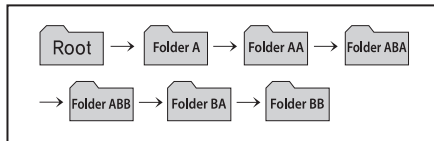

AUX

AUX is used to play external MEDIA currently connected with the AUX terminal. AUX mode will automatically start when an external device is connected to the AUX terminal.

If an external device is connected, you can also press the **MEDIA** key to change to AUX mode.



* AUX mode cannot be started unless there is an external device connected to the AUX terminal.

AUX

- Fully insert the AUX cable into the AUX terminal for use.

1
2
3
4
5
6
7
8
9

Ignition switch / 4-2
Starting the engine / 4-4
Manual transmission / 4-6
Limited slip differential / 4-8
Locking differential / 4-9
Brake system / 4-10
Steering wheel / 4-16

1

2

3

Driving your vehicle

4

Instrument cluster / 4-18
Gauges / 4-20
Warnings and indicators / 4-23
Rear parking assist system / 4-29
Lighting / 4-32
Wipers and washers / 4-36
Hazard warning flasher / 4-38
Climate control system / 4-39
Windscreen defrosting and defogging / 4-48

5

6

7

8

9

IGNITION SWITCH

1

2

3

4



Ignition switch and anti-theft steering column lock

Ignition switch position

5

6

LOCK

The steering wheel locks to protect against theft. The ignition key can be removed only in the LOCK position. When turning the ignition switch to the LOCK position, push the key inward at the ACC position and turn the key toward the LOCK position.

7

8

9

ACC (Accessory)

The steering wheel is unlocked and electrical accessories are operative.

ON

The warning lights can be checked before the engine is started. This is the normal running position after the engine is started.

Do not leave the ignition switch ON if the engine is not running to prevent battery discharge.

START

Turn the ignition key to the START position to start the engine. The engine will crank until you release the key; then it returns to the ON position. The brake warning lamp can be checked in this position.

* NOTICE

If difficulty is experienced turning the ignition switch to the ACC position, turn the key whilst turning the steering wheel right and left to release the tension.

⚠ WARNING

When you intend to park or stop the vehicle with the engine on, be careful not to depress the accelerator pedal for a long period of time. It may overheat the engine or exhaust system and cause fire.

⚠ WARNING - Ignition key

- Never turn the ignition switch to LOCK or ACC whilst the vehicle is moving. This would result in loss of directional control and braking function, which could cause an immediate accident.
- The anti-theft steering column lock is not a substitute for the parking brake. Before leaving the driver's seat, always make sure the shift lever is engaged in 1st gear, set the parking brake fully and shut the engine off. Unexpected and sudden vehicle movement may occur if these precautions are not taken.

(Continued)

(Continued)

- Never reach for the ignition switch, or any other controls through the steering wheel whilst the vehicle is in motion. The presence of your hand or arm in this area could cause a loss of vehicle control, an accident and serious bodily injury or death.
- Do not place any movable objects around the driver's seat as they may move whilst driving, interfere with the driver and lead to an accident.

1

2

3

4

5

6

7

8

9

STARTING THE ENGINE

⚠ WARNING

- Always wear appropriate shoes when operating your vehicle. Unsuitable shoes (high heels, ski boots, etc.) may interfere with your ability to use the brake and accelerator pedal, and the clutch (if equipped).
- Do not start the vehicle with the accelerator pedal depressed. The vehicle can move and lead to an accident.
- Wait until the engine rpm is normal. The vehicle may suddenly move if the brake pedal is released when the rpm is high.

To start the diesel engine when the engine is cold, it has to be pre-heated before starting the engine and then have to be warmed up before starting the driving.

1. Make sure the parking brake is applied.
2. **Manual Transmission** - Depress the clutch pedal fully and shift the transmission into the Neutral. Keep the clutch pedal depressed whilst cranking the engine.
3. Turn the ignition switch ON position to pre-heat the engine. Then the glow indicator light will illuminate.

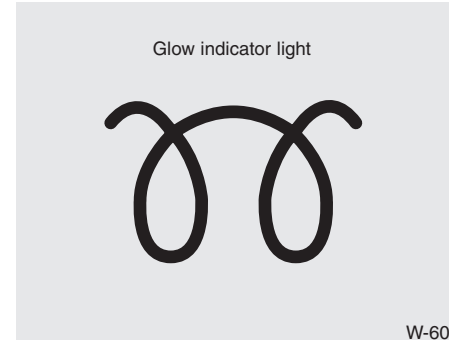

4. If the glow indicator light goes out, turn the ignition switch to START and hold it there until the engine starts (a maximum of 10 seconds), then release the key.

*** NOTICE**

If the engine were not started within 10 seconds after the preheating is completed, turn the ignition key once more to the LOCK position during 30 seconds, and then to the ON position, in order to pre-heat again.

CAUTION

Do not keep the starter engaged for more than 10 seconds. If the engine stalls or falters in starting, wait 30 seconds before reengaging the starter; otherwise you may damage it.

If the engine cannot be started, we recommend that the system be checked by an authorised Kia dealer.

*** NOTICE**

Whether the engine is warm or cold, it should be started without first depressing the accelerator pedal. However, if the engine is unusually difficult to restart when it is warm (fails to start after repeated attempts without depressing the accelerator pedal), start it whilst depressing the accelerator pedal about halfway.

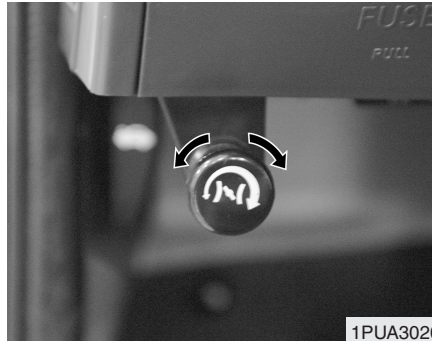

1PUA3020

Starting the cold engine

1. If the glow indicator light goes out, start the engine.
2. Turn the warm-up switch clockwise after starting the engine.
3. Turn the warm-up switch OFF by rotating it counterclockwise if the engine temperature gauge moves slightly.

If you do not use the warm-up switch, your vehicle may have the excessive fuel consumption and be damaged in the emission system.

*** NOTICE**

If you drive with turning the warm-up switch ON, the fuel consumption will be increased excessively. Also, this could the failure of engine.

Starting and stopping the engine for turbo charger intercooler

1. Do not race or accelerate the engine immediately after starting.

If the engine is cold, idle for several seconds before sufficient lubrication is ensured in the turbo charger unit.

2. After high speed or extended driving, requiring a heavy engine load, run the engine on idle condition about 1 minute before turning it off.

This idle time will allow the turbo charger to cool prior to shutting the engine off.

WARNING

Do not turn the engine off immediately after it has been subjected to a heavy load. Doing so may cause severe damage to the engine or turbo charger unit.

1

2

3

4

5

6

7

8

9

MANUAL TRANSMISSION

■ Type A

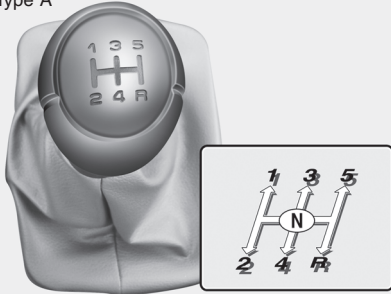

■ Type B

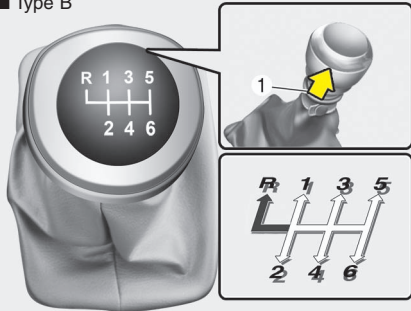

⇒ The shift lever can be moved without pulling the ring (1).

➔ The ring (1) must be pulled up whilst moving the shift lever.

OPU032018/OPU032019L

Manual transmission operation

The manual transmission has 5 (or 6) forward gears.

Press the clutch pedal down fully whilst shifting, then release it slowly. If your vehicle is equipped with an ignition lock switch, the engine will not start when starting the engine without depressing the clutch pedal. (if equipped)

A special safety feature prevents inadvertent shifting from 5 (Type A) to R (Reverse). The gearshift lever must be returned to the neutral position before shifting into R (Reverse).

Make sure the vehicle is completely stopped before shifting into R (Reverse).

Never operate the engine with the tachometer (rpm) in the red zone.

* NOTICE

To avoid premature clutch wear and damage, do not drive with your foot resting on the clutch pedal. Also, don't use the clutch to hold the vehicle stopped on an upgrade, whilst waiting for a traffic light, etc.

CAUTION

- **When shifting into 5th or 6th gear, press the shift lever to the right. Otherwise, the engine could be damaged by accidentally engaging 3rd or 4th gear.**
- **Do not downshift more than 2 gears or downshift the gear when the engine is running at high speed (5,000 RPM or higher). Such a downshifting may damage the engine, clutch and the transaxle.**

⚠ WARNING - Manual transmission

- Before leaving the driver's seat, always set the parking brake fully and shut the engine off. Then make sure the transmission is shifted into 1st gear when the vehicle is parked on a level or uphill grade, and shifted into R (Reverse) gear on a downhill ground. Unexpected and sudden vehicle movement can occur if these precautions are not followed in the order identified.
- Starting the engine without depressing the clutch pedal, when the parking brake is released and the shift lever not in the N(Neutral) position, the vehicle may move and cause a serious accident.

Downshifting

When you must slow down in heavy traffic or whilst driving up steep hills, downshift before the engine starts to "labor". Downshifting reduces the chance of stalling and gives better acceleration when you again need to increase your speed. When the vehicle is travelling down steep hills, downshifting helps maintain safe speed and prolongs brake life.

⚠ CAUTION

- *To avoid premature clutch wear and damage, do not drive with your foot resting on the clutch pedal. Also, don't use the clutch to hold the vehicle stopped on an uphill grade, whilst waiting for a traffic light, etc.*
- *To prevent possible damage to the clutch system, do not start with the 2nd (second) gear engaged except when you start on a slippery road.*

Using the clutch

The clutch should be pressed all the way to the floor before shifting, then released slowly. The clutch pedal should always be fully released whilst driving. Do not rest your foot on the clutch pedal whilst driving. This can cause unnecessary wear. Do not partially engage the clutch to hold the vehicle on an incline. This causes unnecessary wear. Use the foot brake or parking brake to hold the vehicle on an incline. Do not operate the clutch pedal rapidly and repeatedly

1

2

3

4

5

6

7

8

9

LIMITED SLIP DIFFERENTIAL (EXCEPT 2.5 ENGINE, IF EQUIPPED)

WARNING

To avoid injury, never run the engine with one wheel off the ground, such as when changing a tyre.

1

2

3

4

A limited slip differential, if equipped, is for the rear wheel differential only. The features of this limited slip differential are described below;

5

Just as with conventional differential, the wheel on one side is allowed to turn at a different speed from the wheel on the other side when the vehicle is cornering.

6

7

The difference between the limited slip differential and a conventional differential is that if the wheel on one side of the vehicle loses traction, a greater amount of torque is applied to the rear wheel on the other side to improve traction.

8

9

LOCKING DIFFERENTIAL (FOR 2.5 ENGINE, IF EQUIPPED)

A locking differential, if equipped, is for the rear wheel differential only. The features of this locking differential are described below:

Just as with a conventional differential, the wheel on one side is allowed to turn at a different speed from the wheel on the other side when the vehicle is cornering. The difference between the locking differential and a conventional differential is that if the wheel on one side of the vehicle loses traction, a greater amount of torque is applied to the rear wheel on the other side to improve traction.

* NOTICE

In a stationary position, the LD (Locking Differential) will operate when the difference of the revolution speed between the rear right wheel and the rear left wheel occurs.

The following procedures can be used to confirm that the locking differential is functioning properly:

- (1) Position the vehicle so that one wheel is on a dry paved surface and the other on ice, snow, mud, etc. Drive the vehicle, and observe the operation of the locking differential. The vehicle should not become stuck if the differential is functioning properly.
- (2) Depress the accelerator pedal gradually, and then when traction is good, depress it forcefully. If the vehicle accelerates well, the differential is functioning properly.

* NOTICE

Usually a locking differential will operate and release automatically but occasionally it may not release automatically.

At this time you will feel the tyre being dragged when you are driving or cornering. You can release it manually by slightly turning the steering wheel right and left whilst the vehicle is moving slowly.

CAUTION

- *Never start the engine with the gearshift lever placed in the forward or reverse whilst one of the rear wheels is jacked up and the other in contact with the ground; doing so may cause the vehicle to jump forward.*
- *If one of the rear wheels begins to spin in mud, snow, etc., the vehicle can sometimes be driven out by depressing the accelerator pedal further; however, avoid running the engine continuously at high rpm because doing so could damage the locking differential.*

1

2

3

4

5

6

7

8

9

BRAKE SYSTEM

Power brakes

Your vehicle has power-assisted brakes that adjust automatically through normal usage.

In the event that the power-assisted brakes lose power because of a stalled engine or some other reason, you can still stop your vehicle by applying greater force to the brake pedal than you normally would. The stopping distance, however, will be longer.

When the engine is not running, the reserve brake power is partially depleted each time the brake pedal is applied. Do not pump the brake pedal when the power assist has been interrupted.

Pump the brake pedal only when necessary to maintain steering control on slippery surfaces.

In the event of brake failure

If service brakes fail to operate whilst the vehicle is in motion, you can make an emergency stop with the parking brake. The stopping distance, however, will be much greater than normal.

⚠ WARNING - Parking brake
Pulling the parking brake whilst the vehicle is moving at normal speeds can cause a sudden loss of control of the vehicle. If you must use the parking brake to stop the vehicle, use great caution in applying the brake.

⚠ WARNING - Brakes

- Do not drive with your foot resting on the brake pedal. This will create abnormal high brake temperatures, excessive brake lining and pad wear, and increased stopping distances.
- When descending a long or steep hill, shift to a lower gear and avoid continuous application of the brakes. Continuous brake application will cause the brakes to overheat and could result in a temporary loss of braking performance.
- Wet brakes may result in the vehicle not slowing down at the usual rate and pulling to one side when the brakes are applied. Applying the brakes lightly will indicate whether they have been affected in this way. Always test your brakes in this fashion after driving through deep water. To dry the brakes, apply them lightly whilst maintaining a safe forward speed until brake performance returns to normal.

Disc brakes wear indicator

Your vehicle has front disc brakes.

When your front brake pads are worn and it's time for new pads, you will hear a high-pitched warning sound from your front brakes. You may hear this sound come and go or it may occur whenever you depress the brake pedal.

Please remember that some driving conditions or climates may cause a brake squeal when you first apply (or lightly apply) the brakes. This is normal and does not indicate a problem with your brakes.

* NOTICE

To avoid costly brake repairs, do not continue to drive with worn brake pads.

WARNING - Brake wear

This brake wear warning sound means your vehicle needs service. If you ignore this audible warning, you will eventually lose braking performance, which could lead to a serious accident.

CAUTION

Always replace front brake pads or rear brake linings as complete front or rear axle sets.

Rear drum brakes

Your rear drum brakes do not have wear indicators. Therefore, have the rear brake linings inspected if you hear a rear brake rubbing noise. Also have your rear brakes inspected each time you change or rotate your tyres and when you have the front brakes replaced.

1

2

3

4

5

6

7

8

9

1

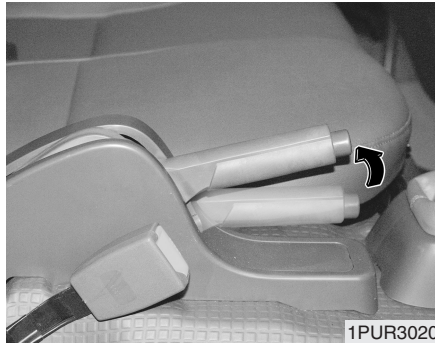

2

3

4

Parking brake

To apply the parking brake, pull the parking brake handle fully and firmly upward whilst applying the service brake.

5

6

7

CAUTION

Driving with the parking brake applied will cause excessive brake pad/lining and brake rotor wear.

8

9

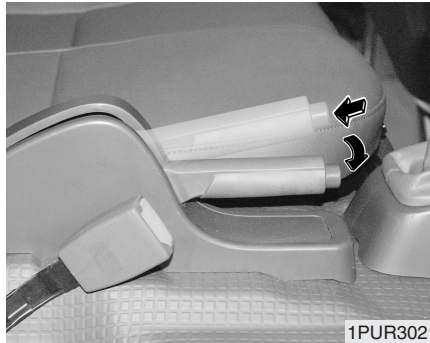

To release the parking brake, pull the handle up slightly and push the release button, then lower the handle to the released position whilst holding the button in.

WARNING - Parking brake

- To prevent unintentional movement when stopped and leaving the vehicle, do not use the gearshift lever in place of the parking brake. Set the parking brake AND make sure the gearshift lever is securely positioned in 1st (First) gear or R (Reverse).
- Never allow a person who is unfamiliar with the vehicle or children to touch the parking brake. If the parking brake is released unintentionally, serious injury may occur.



W-75

Check the brake warning light by turning the ignition switch ON (do not start the engine). This light will be illuminated when the parking brake is applied with the ignition switch in the START or ON position.

Before driving, be sure the parking brake is fully released and the brake warning light is off.

If the brake warning light remains on after the parking brake is released, there may be a malfunction in the brake system. Immediate attention is necessary.

If at all possible, cease driving the vehicle immediately. If that is not possible, use extreme caution whilst operating the vehicle and only continue to drive the vehicle until you can reach a safe location or repair shop.

Parking on kerbed streets

- When parking your vehicle on an uphill grade, park as close to the kerb as possible and turn the front wheels away from the kerb so that the front wheels will contact the kerb if the vehicle moves backward.
- When parking your vehicle on a downhill grade, park as close to the kerb as possible and turn the front wheels toward the kerb so that the front wheels will contact the kerb if the vehicle moves forward.

1

2

3

4

5

6

7

8

9

Anti-lock brake system (ABS) (if equipped)

1

⚠ WARNING

ABS will not prevent accidents due to improper or dangerous driving immobilisers. Even though vehicle control is improved during emergency braking, always maintain a safe distance between you and objects ahead. Vehicle speeds should always be reduced during extreme road conditions.

2

The braking distance for vehicles equipped with an anti-lock braking system may be longer than for those without it in the following road conditions.

3

During these conditions the vehicle should be driven at reduced speeds:

4

- Rough, gravel or snow-covered roads.
- With tyre chains installed.

5

(Continued)

6

7

8

9

(Continued)

- On roads where the road surface is pitted or has different surface height.

The safety features of an ABS equipped vehicle should not be tested by high speed driving or cornering. This could endanger the safety of yourself or others.

The ABS continuously senses the speed of the wheels. If the wheels are going to lock, the ABS system repeatedly modulates the hydraulic brake pressure to the wheels.

When you apply your brakes under conditions which may lock the wheels, you may hear a “tik-tik” sound from the brakes, or feel a corresponding sensation in the brake pedal. This is normal and it means your ABS is active.

In order to obtain the maximum benefit from your ABS in an emergency situation, do not attempt to modulate your brake pressure and do not try to pump your brakes.

Press your brake pedal as hard as possible or as hard as the situation allows the ABS to control the force being delivered to the brakes.

* NOTICE

A click sound may be heard in the engine compartment when the vehicle begins to move after the engine is started. These conditions are normal and indicate that the anti-lock brake system is functioning properly.

- Even with the anti-lock brake system, your vehicle still requires sufficient stopping distance. Always maintain a safe distance from the vehicle in front of you.
- Always slow down when cornering. The anti-lock brake system cannot prevent accidents resulting from excessive speeds.
- On loose or uneven road surfaces, operation of the anti-lock brake system may result in a longer stopping distance than for vehicles equipped with a conventional brake system.

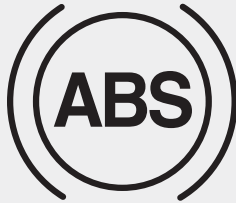

W-78

CAUTION

- *If the ABS warning light is on and stays on, you may have a problem with the ABS. In this case, however, your regular brakes will work normally.*
- *The ABS warning light will stay on for approximately 3 seconds after the ignition switch is ON. During that time, the ABS will go through self-diagnosis and the light will go off if everything is normal. If the light stays on, you may have a problem with your ABS. We recommend that you contact an authorised Kia dealer.*

CAUTION

- *When you drive on a road having poor traction, such as an icy road, and operate your brakes continuously, the ABS will be active continuously and the ABS warning light may illuminate. Pull your vehicle over to a safe place and stop the engine.*
- *Restart the engine. If the ABS warning light is off, then your ABS system is normal. Otherwise, you may have a problem with the ABS. We recommend that you contact an authorised Kia dealer.*

*** NOTICE**

When you jump start your vehicle because of a drained battery, the engine may not run as smoothly and the ABS warning light may turn on at the same time. This happens because of the low battery voltage. It does not mean your ABS is malfunctioning.

- **Do not pump your brakes!**
- **Have the battery recharged before driving the vehicle.**

1

2

3

4

5

6

7

8

9

STEERING WHEEL

Power steering (if equipped)

Power Steering uses energy from the engine to assist you in steering the vehicle. If the engine is off or if the power steering system becomes inoperative, the vehicle may still be steered, but it will require increased steering effort.

Should you notice any change in the effort required to steer during normal vehicle operation, we recommend that the power steering checked by an authorised Kia dealer.

* NOTICE

- Never hold the steering wheel against a stop (extreme right or left turn) for more than 5 seconds with the engine running. Holding the steering wheel for more than 5 seconds in either position may cause damage to the power steering pump.
- If the power steering drive belt breaks or if the power steering pump malfunctions, the steering effort will greatly increase.

* NOTICE

If the vehicle is parked for extended periods outside in cold weather (below -10 °C/14 °F), the power steering may require increased effort when the engine is first started. This is caused by increased fluid viscosity due to the cold weather and does not indicate a malfunction.

When this happens, increase the engine RPM by depressing accelerator until the RPM reaches 1,500 rpm then release or let the engine idle for two or three minutes to warm up the fluid.

Tilt steering (if equipped)

A tilt steering wheel allows you to adjust the steering wheel before you drive. You can also raise it to the highest level to give your legs more room when you exit and enter the vehicle.

The steering wheel should be positioned so that it is comfortable for you to drive, whilst permitting you to see the instrument panel warning lights and gauges.

WARNING

- Never adjust the angle of steering wheel whilst driving. You may lose your steering control and cause severe personal injury or accidents.
- After adjusting, push the steering wheel both up and down to be certain it is locked in position.

1

2

3

4

5

6

7

8

9

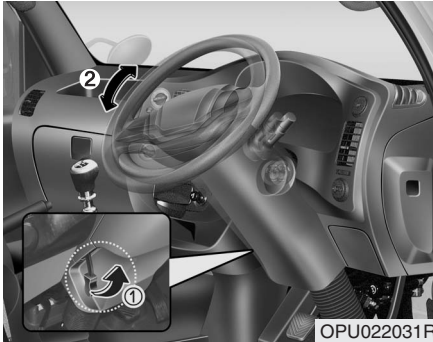

1. Pull the lever upward and hold it to unlock.
2. Raise or lower the steering wheel to the desired position.
3. After adjust, release the lever.

Be sure to adjust the steering wheel to the desired position before driving.

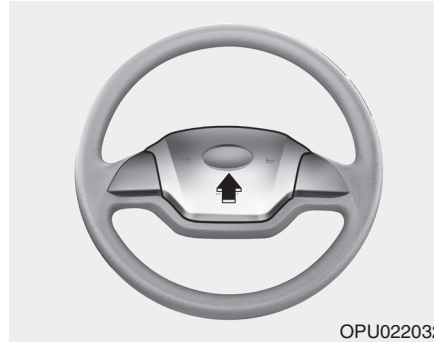

Horn

To sound the horn, press the horn symbol on your steering wheel. Check the horn regularly to be sure it operates properly.

CAUTION

- To sound the horn, press the area indicated by the horn symbol on your steering wheel (see illustration). The horn will operate only when this area is pressed.
- Do not strike the horn severely to operate it, or hit it with your fist. Do not press on the horn with a sharp-pointed object.

1

2

3

4

5

6

7

8

9

INSTRUMENT CLUSTER

Without tachometer

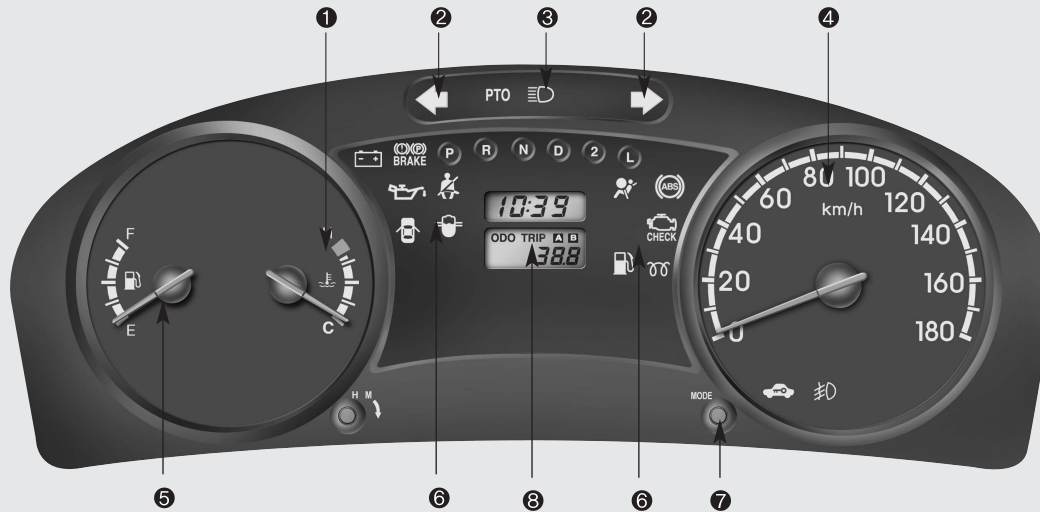

1. Engine temperature gauge

2. Turn signal indicators

3. Headlight high beam indicator

4. Speedometer

5. Fuel gauge

6. Warning and indicator lights

7. Tripmeter mode/reset button

8. Odometer / Tripmeter

* The actual instrument cluster in the vehicle may differ from the illustration.

OPU022437R

With tachometer



1. Engine temperature gauge

2. Turn signal indicators

3. Headlight high beam indicator

4. Speedometer

5. Fuel gauge

6. Warning and indicator lights

7. Tripmeter mode/reset button

8. Odometer / Tripmeter

9. Tachometer

* The actual instrument cluster in the vehicle may differ from the illustration.

OPU22037R



GAUGES

■ Type A



■ Type C



■ Type E



■ Type B



■ Type D



OPU022439/OPU022440/
OPU022441/OPU022442/OPU022443

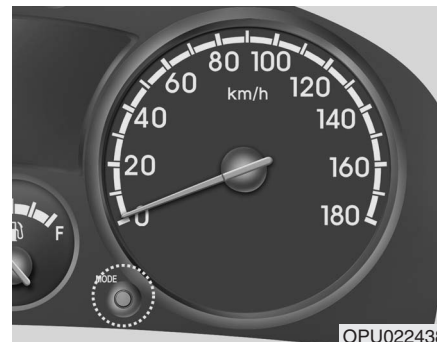

OPU022438

Odometer/Tripmeter

You can choose the odometer, tripmeter A and tripmeter B by pressing the tripmeter mode button.

Speedometer

The speedometer indicates the forward speed of the vehicle.

1

2

3

4

5

6

7

8

9



Odometer

The odometer indicates the total distance the vehicle has been driven.



Tripmeter

TRIP A: Tripmeter A

TRIP B: Tripmeter B

The tripmeter indicates the distance of individual trips selected by the driver. Tripmeter A and B can be reset to 0 by pressing the reset button for 1 second or more, and then releasing.



Tachometer (if equipped)

The tachometer indicates the approximate number of engine revolutions per minute (rpm).

Use the tachometer to select the correct shift points and to prevent lugging and/or over-revving the engine.

The tachometer pointer may move slightly when the ignition switch is in ACC or ON position with the engine OFF. This movement is normal and will not affect the accuracy of the tachometer once the engine is running.

1

2

3

4

5

6

7

8

9

*** NOTICE**

Do not operate the engine within the tachometer's red zone.

This may cause severe engine damage.

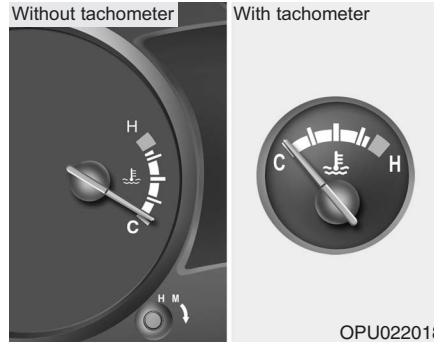

Engine temperature gauge

This gauge shows the temperature of the engine coolant when the ignition switch is ON.

Do not continue driving with an overheated engine. If your vehicle overheats, refer to “Overheating” in the Index.

*** NOTICE**

If the gauge pointer moves beyond the normal range area toward the “H” position, it indicates overheating that may damage the engine.



Fuel gauge

The fuel gauge indicates the approximate amount of fuel remaining in the fuel tank.

Fuel tank capacity - 60 litres (15.9 US gal.).

The fuel gauge is supplemented by a low fuel warning light, which will illuminate when the fuel level has dropped to about 8 litres (2.1 US gal.).

CAUTION

Avoid driving with a very low fuel level. If you run out of fuel, it could cause the engine to misfire and result in excessive loading of the catalytic converter.

1

2

3

4

5

6

7

8

9

WARNINGS AND INDICATORS

Warning lights / audible indicators

Checking operation

All warning lights are checked by turning the ignition switch ON (do not start the engine). If any light that does not illuminate, we recommend that the system be checked by an authorised Kia dealer.

After starting the engine, check to make sure that all warning lights are off. If any are still on, this indicates a situation that needs attention. When releasing the parking brake, the brake system warning light should go off. The fuel warning light will stay on if the fuel level is low.

Engine oil pressure warning



This warning light indicates the engine oil pressure is low.

If the warning light illuminates whilst driving:

1. Drive safely to the side of the road and stop.
2. With the engine off, check the engine oil level. If the level is low, add oil as required.

If the warning light remains on after adding oil or if oil is not available, we recommend that you call an authorised Kia dealer.

* NOTICE

If the engine is not stopped immediately, severe damage could result.

Charging system warning

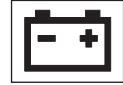

This warning light indicates a malfunction of either the generator or electrical charging system.

If the warning light comes on whilst the vehicle is in motion:

1. Drive to the nearest safe location.
2. With the engine off, check the generator drive belt for looseness or breakage.
3. If the belt is adjusted properly, a problem exists somewhere in the electrical charging system. We recommend that the system be checked by an authorised Kia dealer.

1

2

3

4

5

6

7

8

9

Safety belt warning



Anti-lock brake system (ABS) warning light (if equipped)



1

As a reminder to the driver and passenger, safety belt warning light will blink for approximately 6 seconds each time you turn the ignition switch ON.

2

3

If the driver's lap/shoulder belt is not fastened when the key is turned ON or if it is unfastened after the key is ON, the safety belt warning light blinks for 6 seconds. If the system does not operate as described, we recommend that you contact an authorised Kia dealer.

4

5

6

7

8

9

This warning light illuminates if the ignition switch is turned to ON and goes off in approximately 3 seconds if the system is operating normally.

If the ABS warning light remains on, comes on whilst driving, or does not come on when the ignition switch is turned to the ON position, this indicates that the ABS may have malfunctioned.

If this occurs, we recommend that the system be checked by an authorised Kia dealer. The normal braking system will still be operational, but without the assistance of the anti-lock brake system.

WARNING

If the both ABS and Brake warning lights are on and stay on, your vehicle's brake system will not work normally. So you may experience an unexpected and dangerous situation during sudden braking. In this case, avoid high speed driving and abrupt braking. We recommend that the system be checked by an authorised Kia dealer.

Parking brake & brake fluid warning



Parking brake warning

This light is illuminated when the parking brake is applied with the ignition switch in the START or ON position. The warning light should go off when the parking brake is released.

Low brake fluid level warning

If the warning light remains on, it may indicate that the brake fluid level in the reservoir is low.

If the warning light remains on:

1. Drive carefully to the nearest safe location and stop your vehicle.
2. With the engine stopped, check the brake fluid level immediately and add fluid as required. Then check all brake components for fluid leaks.

3. Do not drive the vehicle if leaks are found, the warning light remains on or the brakes do not operate properly. We recommend that you contact an authorised Kia dealer.

To check bulb operation, check whether the parking brake and brake fluid warning light illuminates when the ignition switch is in the ON position.

⚠ WARNING

Driving the vehicle with a warning light on is dangerous. If the brake warning light remains on, we recommend that the system be checked by an authorised Kia dealer.

Low fuel level warning



This warning light indicates the fuel tank is nearly empty. When it comes on, you should add fuel as soon as possible. Driving with the fuel level warning light on or with the fuel level below "E" can cause the engine to misfire and damage the catalytic converter.

Door ajar warning



This warning light illuminates when a door is not closed securely with the ignition in any position.

1

2

3

4

5

6

7

8

9

- 1
- 2
- 3
- 4
- 5
- 6
- 7
- 8
- 9

Headlight high beam indicator



This indicator illuminates when the headlights are on and in the high beam position or when the turn signal lever is pulled into the Flash-to-Pass position.

Front fog light indicator (if equipped)



This indicator comes on when the front fog lights are ON.

Rear fog light indicator (if equipped)

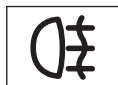

This indicator illuminates when the rear fog lights are ON.

Turn signal indicator

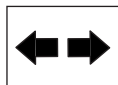

The blinking green arrows on the instrument cluster show the direction indicated by the turn signals. If the arrow comes on but does not blink, blinks more rapidly than normal, or does not illuminate at all, a malfunction in the turn signal system is indicated.

We recommend that the turn signal system be checked and repaired by an authorised Kia dealer.



Malfunction indicator (if equipped)



This indicator light is part of the Engine Control System which monitors various emission control system components. If this light illuminates whilst driving, it indicates that a potential problem has been detected somewhere in the emission control system.

Generally, your vehicle will continue to be drivable and will not need towing, but we recommend that the system be checked by an authorised Kia dealer.

CAUTION

- *Prolonged driving with the Emission Control System Malfunction Indicator Light () illuminated may cause damage to the emission control systems which could affect drivability and/or fuel economy.*
- *If the Emission Control System Malfunction Indicator Light () begins to flash ON and OFF, potential catalytic converter damage is possible which could result in loss of engine power. We recommend that the system be inspected by an authorised Kia dealer.*

CAUTION - Diesel engine (if equipped with DPF)

When the malfunction indicator light is blinks, it may stop blinking after driving the vehicle at more than 60km/h (37 mph) or at more than second gear with 1500 ~ 2000 engine rpm for a certain time (for about 25 minutes).

If the malfunction indicator light continues to be blinked in spite of the procedure, we recommend that the system be checked by an authorised Kia dealer.

If you continue to drive with the malfunction indicator light blinking for a long time, the DPF system can be damaged and fuel consumption can be worsen.

CAUTION - Diesel engine

If the Emission Control System Malfunction Indicator Light blinks, some error related to the injection quantity adjustment occurs which could result in loss of engine power, combustion noise and poor emission. We recommend that the system be inspected by an authorised Kia dealer.

1

2

3

4

5

6

7

8

9

Glow indicator

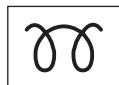

This light is turned on during warm-up and turned off after it.

*** NOTICE**

If the glow indicator continues to illuminate after the engine has warmed up or whilst driving, we recommend that the system be checked by an authorised Kia dealer.

Fuel filter warning light



The light comes on if water in the fuel filter is accumulated more than normal. Drain water if the light is turned on. Driving with the light on may damage the engine.

Safety belt warning chime (if equipped)

If the driver's seat belt is not fastened when the ignition key is turned "ON" or if it is disconnected after the key is ON, the safety belt warning chime will sound for approximately 6 seconds.

Key reminder warning chime (if equipped)

If the driver's door is opened and the ignition key is left in the ignition switch in the LOCK or ACC position, the key reminder warning chime will sound. This is to prevent you from locking your keys in the vehicle.

Parking start warning sound (if equipped)

If the vehicle driven at 10km/h (6mph) for more 2~3 than seconds, the warning chime will sound continuously when the parking brake engaged.

1

2

3

4

5

6

7

8

9

REAR PARKING ASSIST SYSTEM (IF EQUIPPED)

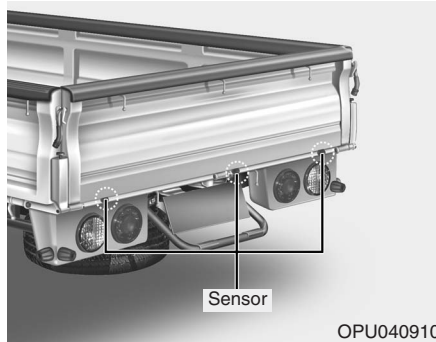

OPU040910

The rear parking assist system assists the driver during backward movement of the vehicle by chiming if any object is sensed within a distance of 120 cm (47 in.) behind the vehicle. This system is a supplemental system and it is not intended to nor does it replace the need for extreme care and attention of the driver. The sensing range and objects detectable by the back sensors are limited. Whenever backing-up, pay as much attention to what is behind you as you would in a vehicle without a rear parking assist system.

⚠ WARNING

The rear parking assist system is a supplementary function only. The operation of the rear parking assist system can be affected by several factors (including environmental conditions). It is the responsibility of the driver to always check the area behind the vehicle before backing up.

Operation of the rear parking assist system

Operating condition

- This system will activate when backing up with the ignition key ON.
- If the vehicle is moving at a speed over 5 km/h (3 mph), the system may not be activated correctly.
- The sensing distance whilst the rear parking assist system is in operation is approximately 120 cm (47 in.).
- When more than two objects are sensed at the same time, the closest one will be recognized first.

Types of warning sound

- When an object is 120 cm to 81 cm (47 in. to 32 in.) from the rear bumper : Buzzer beeps intermittently
- When an object is 80 cm to 41 cm (31 in. to 16 in.) from the rear bumper : Buzzer beeps more frequently
- When an object is within 40 cm (15 in.) of the rear bumper : Buzzer sounds continuously.

1

2

3

4

5

6

7

8

9

Non-operational conditions of rear parking assist system

The rear parking assist system may not operate properly when:

1. Moisture is frozen to the sensor. (It will operate normally when the moisture has been cleared.)
2. The sensor is covered with foreign matter, such as snow or water, or the sensor cover is blocked. (It will operate normally when the material is removed or the sensor is no longer blocked.)
3. Driving on uneven road surfaces (unpaved roads, gravel, bumps, gradient).
4. Objects generating excessive noise (vehicle horns, loud motorcycle engines, or truck air brakes) are within range of the sensor.
5. Heavy rain or water spray exists.
6. Wireless transmitters or mobile phones are within range of the sensor.
7. The sensor is covered with snow.
8. Trailer towing

The detecting range may decrease when:

1. The sensor is stained with foreign matter such as snow or water. (The sensing range will return to normal when removed.)
2. Outside air temperature is extremely hot or cold.

The following objects may not be recognized by the sensor:

1. Sharp or slim objects such as ropes, chains or small poles.
2. Objects which tend to absorb the sensor frequency such as clothes, spongy material or snow.
3. Undetectable objects smaller than 1 m (40 in.) and narrower than 14 cm (6 in.) in diameter.

CAUTION

1. *The rear parking assist system may not sound sequentially depending on the speed and shapes of the objects detected.*
2. *The rear parking assist system may malfunction if the vehicle bumper height or sensor installation has been modified or damaged. Any non-factory installed equipment or accessories may also interfere with the sensor performance.*
3. *The sensor may not recognize objects less than 40 cm (15 in.) from the sensor, or it may sense an incorrect distance. Use caution.*
4. *When the sensor is frozen or stained with snow, dirt, or water, the sensor may be inoperative until the stains are removed using a soft cloth.*
5. *Do not push, scratch or strike the sensor. Sensor damage could occur.*

CAUTION

This system can only sense objects within the range and location of the sensors; It can not detect objects in other areas where sensors are not installed. Also, small or slim objects, such as poles or objects located between sensors may not be detected by the sensors.

Always visually check behind the vehicle when backing up.

Be sure to inform any drivers of the vehicle that may be unfamiliar with the system regarding the systems capabilities and limitations.

Your new vehicle warranty does not cover any accidents or damage to the vehicle or its occupants due to a rear parking assist system malfunction.

Always drive safely and cautiously.

WARNING

Pay close attention when the vehicle is driven close to objects on the road, particularly pedestrians, and especially children. Be aware that some objects may not be detected by the sensors, due to the object's distance, size or material, all of which can limit the effectiveness of the sensor. Always perform a visual inspection to make sure the vehicle is clear of all obstructions before moving the vehicle in any direction.

*** NOTICE**

If you don't hear an audible warning sound or if the buzzer sounds intermittently when shifting the gear to "R" position, this may indicate a malfunction in the rear parking assist system. If this occurs, we recommend that the system be checked by an authorised Kia dealer.

1

2

3

4

5

6

7

8

9

LIGHTING

Battery saver function (if equipped)

1

• The purpose of this feature is to prevent the battery from being discharged. The system automatically turns off the parking lights when the driver removes the ignition key and opens the driver-side door.

2

• With this feature, the parking lights will be turned off automatically if the driver parks on the side of road at night.

3

4

If necessary, to keep the lights on when the ignition key is removed, perform the following :

5

1) Open the driver-side door.

6

2) Turn the parklights off and on again using the light switch on the steering column.

7

8

9

CAUTION

If the driver gets out of the vehicle through other doors (except driver's door), the battery saver function does not operate. Therefore, It causes the battery to be discharged. In this case, make sure to turn off the lamp before getting out of the vehicle.



Lighting control

The light switch has a Headlight and a Taillight position.

To operate the lights, turn the knob at the end of the control lever to one of the following positions:

- ① OFF position
- ② Taillight position
- ③ Headlight position

Taillight position (尾灯)

When the light switch is in the taillight position (1st position), the tail, position, license and instrument panel lights are on.

Headlight position (ヘッド)

When the light switch is in the headlight position (2nd position) the head, tail, position, license and instrument panel lights are on.

* NOTICE

The ignition must be in the ON position for headlights to operate.

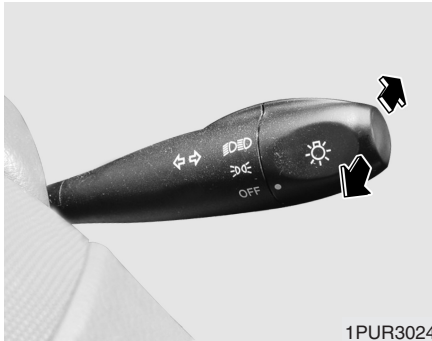

1PUR3024

High - beam operation

To turn on the high beam headlights, push the lever away from you. Pull it back for low beams.

The high-beam indicator will light when the headlight high beams are switched on.



1PUR3025

Flashing headlights

To flash the headlights, pull the lever towards you. It will return to the normal (low-beam) position when released. The headlight switch does not need to be on to use this flashing feature.

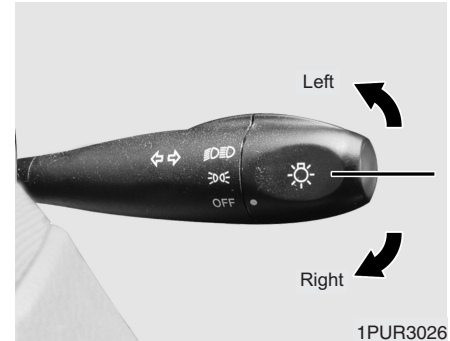

1PUR3026

Turn signals

The ignition switch must be on for the turn signals to function. To turn on the turn signals, move the lever up or down. Green arrow indicators on the instrument panel indicate which turn signal is operating. They will self-cancel after a turn is completed. If the indicator continues to flash after a turn, manually return the lever to the OFF position.

- 1
- 2
- 3
- 4
- 5
- 6
- 7
- 8
- 9

1

Lane change signals

To signal a lane change, move the turn signal lever slightly and hold it in position. The lever will return to the OFF position when released.

2

If an indicator stays on and does not flash or if it flashes abnormally, one of the turn signal bulbs may be burned out and will require replacement.

3

4

* NOTICE

If an indicator flash is abnormally quick or slow, bulb may be burned out or have a poor electrical connection in the circuit.

5

6

7

8

9

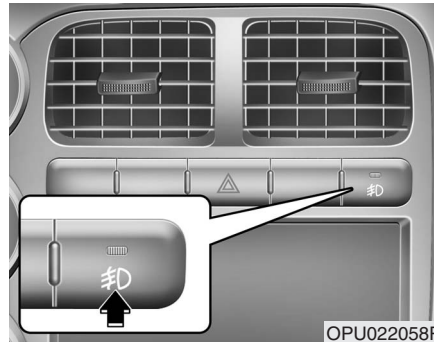

Front fog light (if equipped)

Fog lights are used to provide improved visibility and avoid accidents when visibility is poor due to fog, rain or snow etc. The fog lights will turn on when fog light button is pressed after the taillight is turned on.

To turn off the fog lights, press the button again or turn the taillights off.

* NOTICE

When in operation, the fog lights consume large amounts of vehicle electrical power. Only use the fog lights when visibility is poor or unnecessary battery and generator drain could occur.

Daytime running light (if equipped)

Daytime Running Lights (DRL) can make it easier for others to see the front of your vehicle during the day. DRL can be helpful in many different driving conditions, and it is especially helpful after dawn and before sunset.

The DRL system will make your low-beam headlights turn OFF when:

1. The head light switch is on.
2. The taillight switch is on.
3. Engine stops.



Headlight levelling device (if equipped)

This manual system is provided to avoid obstructing oncoming drivers vision with your headlights. The headlight level can be adjusted by rotating the thumb-wheel switch in accordance with the following settings.

Switch setting:

Position	Loading on	
	Frnt. seats	Luggage
0	driver only	-
1	driver	Full load

- 1
- 2
- 3
- 4
- 5
- 6
- 7
- 8
- 9

WIPERS AND WASHERS

Type A

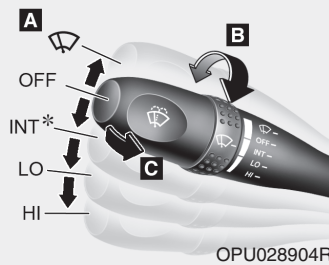

A : Wiper speed control

- (/ MIST) – Single wipe
- OFF (0) – Off
- INT (---) – Intermittent wipe
- LO (1) – Low wiper speed
- HI (2) – High wiper speed

B : Intermittent wipe time adjustment

C : Wash with brief wipes (if equipped)

Type B

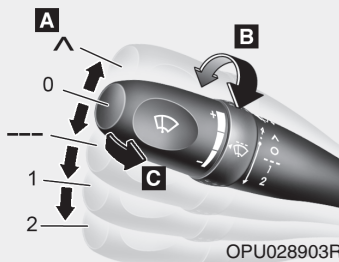

Type A

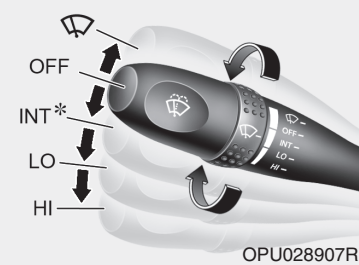

Type B

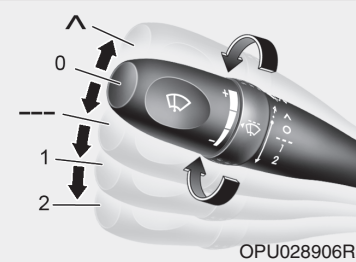

Type C

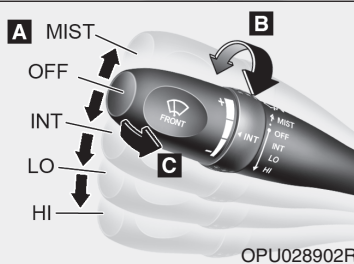

Type C

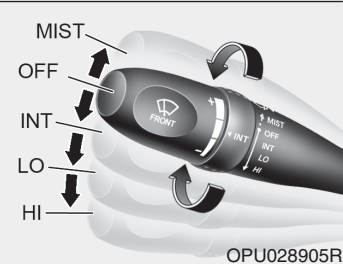

Windscreen wiper/washer

Windscreen wipers

1

2

3

4

5

6

7

8

9

Operates as follows when the ignition switch is turned ON.

 : For a single wiping cycle, push the lever forward and release it with the lever in the OFF (0) position. The wipers will operate continuously if the lever is pushed upward and held.

OFF (0): Wiper is not in operation

INT (---): Wiper operates intermittently at the same wiping intervals. Use this mode in a light rain or mist.

LO (1) : Normal wiper speed

HI (2) : Fast wiper speed

*** NOTICE**

If there is heavy accumulation of snow or ice on the windscreen, defrost the windscreen for about 10 minutes, or until the snow and/or ice is removed before using the windscreen wipers to ensure proper operation. If you do not remove the snow and/or ice before using the wiper and wash-er, it may damage the Wiper and washer system.

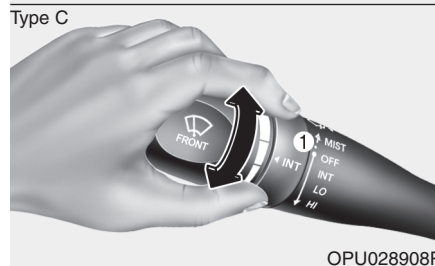
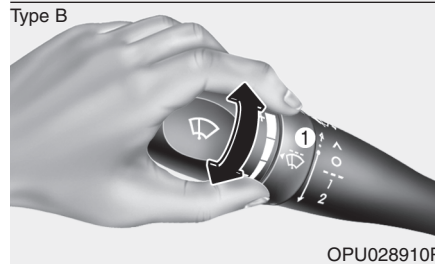
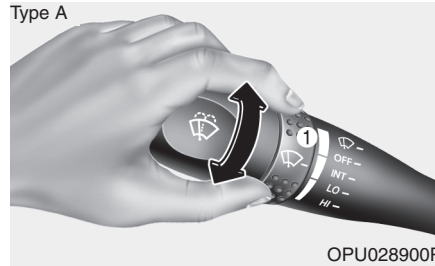

*Variable intermittent wipers
(if equipped)*

Set the lever to the INT (---) position and choose the desired wiper interval by turning the ring.

*** NOTICE**

- To prevent possible damage to the wipers or windscreen, do not operate the wipers when the windscreen is dry.
- To prevent damage to the wiper blades, do not use petrol, kerosene, paint thinner, or other solvents on or near them.
- To prevent damage to the wiper arms and other components, do not attempt to move the wipers manually.

1
2
3
4
5
6
7
8
9

1

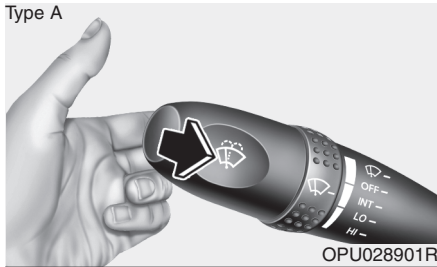

2

3

4

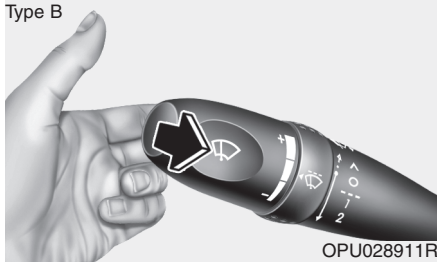

5

6

7

8

9

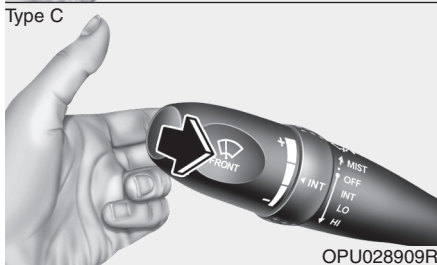

Windscreen washers

In the OFF (0) position, pull the lever gently toward you to spray washer fluid on the windscreen and to run the wipers 1-3 cycles.

Use this function when the windscreen is dirty.

The spray and wiper operation will continue until you release the lever.

If the washer does not work, check the washer fluid level. If the fluid level is not sufficient, you will need to add appropriate non-abrasive windscreen washer fluid to the washer reservoir.

* NOTICE

To prevent possible damage to the washer pump, do not operate the washer when the fluid reservoir is empty.

⚠ WARNING

Do not use the washer in freezing temperatures without 1st warming the windscreen with the defrosters; the washer solution could freeze on contact with the windscreen and obscure your vision.

HAZARD WARNING FLASHER

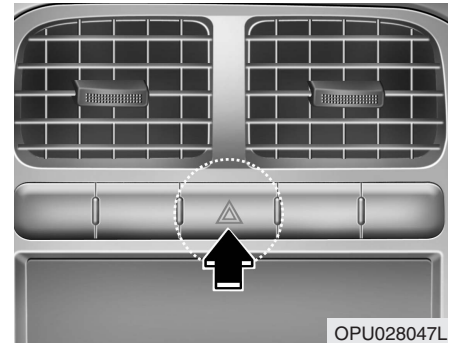

The hazard warning flasher causes the rear tail lights and front turn signal lights to flash on and off, which serves as a warning to other drivers to exercise caution when approaching or passing your vehicle.

To activate the flasher, depress the hazard warning flasher switch. This switch operates in any ignition switch position.

To turn the flashers off, depress the switch again.

CLIMATE CONTROL SYSTEM (IF EQUIPPED)

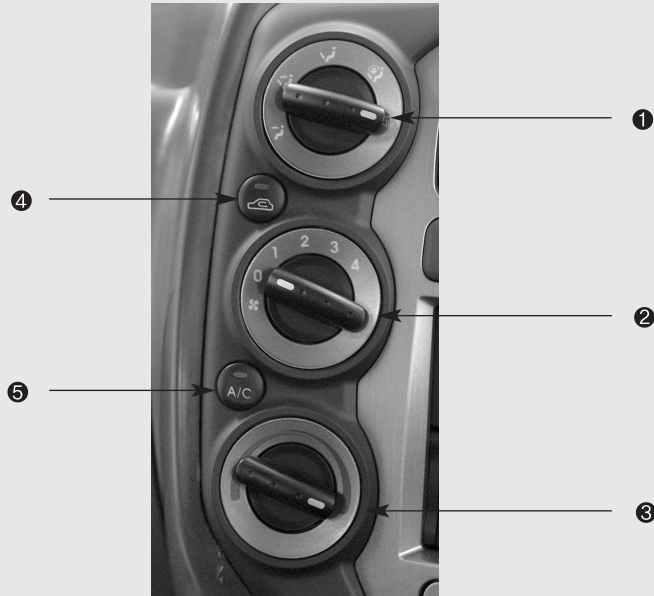

1. Mode selection knob
2. Fan speed control knob
3. Temperature control knob
4. Air intake control button
5. Air conditioning button (if equipped)

CAUTION

Operating the blower when the ignition switch is in the ON position could cause the battery to discharge. Operate the blower when the ignition switch is in the ON position.

1

2

3

4

5

6

7

8

9

1

2

3

4

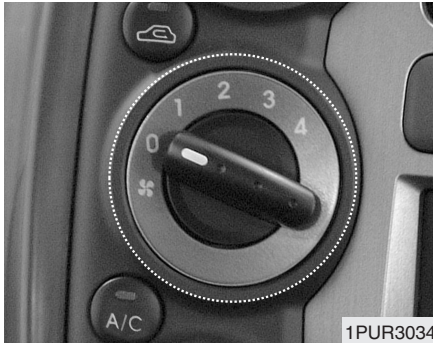

Fan speed control knob

Four (4) adjustable fan speeds are provided which increase as the number increases. The ignition switch must be in the ON position for fan operation.

0 - Fan off

1 - Low speed

2 - Medium speed

3 - High speed

4 - Maximum speed

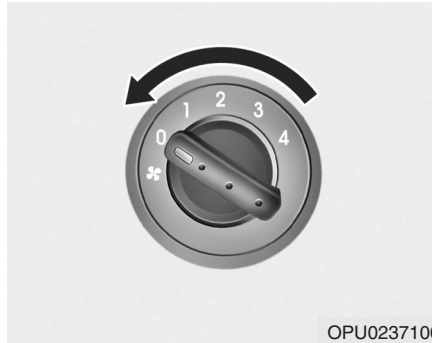

To turn off the blowers

To turn off the blowers, turn the fan speed control knob to the "0" position.



Temperature control knob

The temperature control knob allows you to control the temperature of the air flowing from the ventilation system. To change the air temperature in the passenger compartment turn the knob to the right for warm and hot air or left for cooler air.

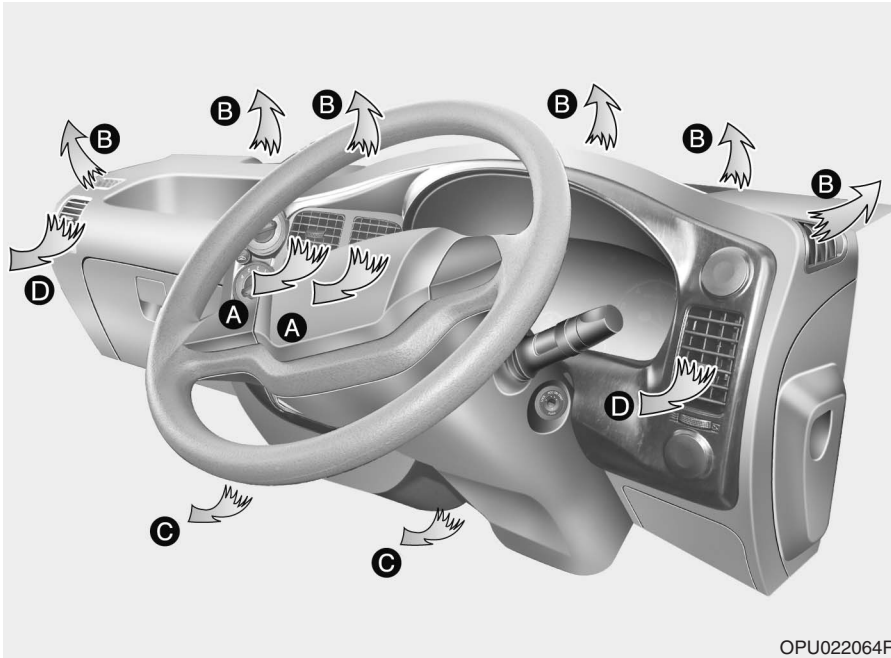

Mode selection knob

The mode selection knob controls the direction of the air flow through the ventilation system.

Face position



Air flow is directed toward the upper body and face. Additionally, each outlet can be controlled to direct the air discharged from the outlet. (outlet port: (A), (D))

Face - floor position



Air flow is directed towards the face and the floor. The air to the floor is warmer than the air to the face (except when the temperature control is set to the extreme cold position). (outlet port: (A), (C), (D))

1

2

3

4

5

6

7

8

9

- 1
- 2
- 3
- 4**
- 5
- 6
- 7
- 8
- 9

Floor position



Most of the air flow is directed to the floor, with a small amount of the air being directed to the windscreen and side window defroster.
(outlet port: Ⓑ, Ⓒ, Ⓓ)

Floor - defrost position



Most of the air flow is directed to the floor and the windscreen with a small amount directed to the side window defrosters.
The outside (fresh) air and air conditioning will be selected automatically.
(outlet port: Ⓑ, Ⓒ, Ⓓ)

Defrost position



Most of the air flow is directed to the windscreen with a small amount of air directed to the side window defrosters.
The outside (fresh) air and air conditioning will be selected automatically.
(outlet port: Ⓑ, Ⓓ)

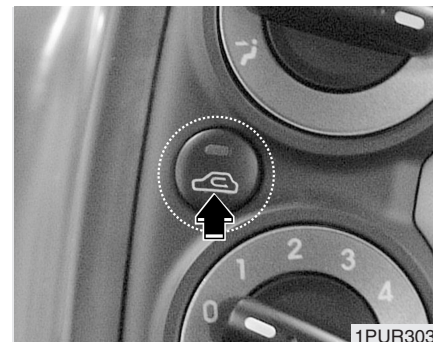

Air intake control button

This is used to select outside (fresh) air position or recirculated air position.
To change the air intake control position, push the control button.

Recirculated air position

The indicator light on the button is illuminated when the recirculated air position is selected.

With the recirculated air position selected, air from passenger compartment will be drawn through the heating system and heated or cooled according to the function selected.

Outside (fresh) air position

The indicator light on the button is not illuminated when the outside (fresh) air position is selected.

With the outside (fresh) air position selected, air enters the vehicle from outside and is heated or cooled according to the function selected.

*** NOTICE**

It should be noted that prolonged operation of the heating in recirculated air position will cause fogging of the windscreen and side windows and the air within the passenger compartment will become stale. In addition, prolonged use of the air conditioning with the “recirculated air position” selected, will result in excessively dry air in the passenger compartment.

⚠ WARNING

- Continued climate control system operation in the recirculated air position may allow humidity to increase inside vehicle which may fog the glass and obscure visibility.
- Do not sleep in a vehicle with air conditioning or heating system on. It may cause serious harm or death due to a drop in the oxygen level and/or body temperature.
- Continued climate control system operation in the recirculated air position can cause drowsiness or sleepiness, and loss of vehicle control. Set the air intake control to the outside (fresh) air position as much as possible whilst driving.

1

2

3

4

5

6

7

8

9

1

2

3

4

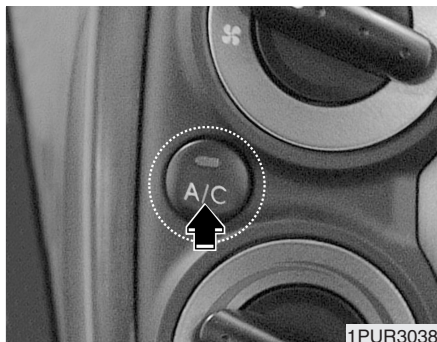

Air conditioning button (if equipped)

Push the A/C button to turn the air conditioning system on (indicator light will illuminate). Push the button again to turn the air conditioning system off.

5

6

7

8





9

System operation

Ventilation



1. Set the mode to the  position.
2. Set the air intake control to the outside (fresh) air position.
3. Set the temperature control to the desired position.
4. Set the fan speed control to the desired speed.

Heating

1. Set the mode to the  position.
2. Set the air intake control to the outside (fresh) air position.
3. Set the temperature control to the desired position.
4. Set the fan speed control to the desired speed.
5. If dehumidified heating is desired, turn the air conditioning system (if equipped) on.
 - If cool air is desired at face level for bi-level operation, set the mode to the  position.
 - If the windscreen fogs up, set the mode to the  ,  position.

Air conditioning (if equipped)

All Kia Air Conditioning Systems are filled with environmentally friendly R-134a refrigerant.

1. Start the engine. Push the air conditioning button.
 2. Set the mode to the  position.
 3. Set the air intake control to the outside air or recirculated air position.
 4. Set the temperature control knob to the desired position.
 5. Set the fan speed control to the desired speed.
 6. Adjust the fan speed control and temperature control to maintain maximum comfort.
- If warmer air is desired at floor level for bi-level operation, set the mode to the  position and adjust the temperature control to maintain maximum comfort.
 - When maximum cooling is desired, set the temperature control to the extreme left position, set the air intake control to the recirculated air position, then set the fan speed control to the highest speed.

*** NOTICE**

- When using the air conditioning system, monitor the temperature gauge closely whilst driving up hills or in heavy traffic when outside temperatures are high. Air conditioning system operation may cause engine overheating. Continue to use the blower fan but turn the air conditioning system off if the temperature gauge indicates engine overheating.
- When opening the windows in humid weather air conditioning may create water droplets inside the vehicle. Since excessive water droplets may cause to damage to electrical equipment, air conditioning should only be run with the windows closed.

1

2

3

4

5

6

7

8

9

Air conditioning system operation tips

- 1
 - 2
 - 3
 - 4
 - 5
 - 6
 - 7
 - 8
 - 9
- If the vehicle has been parked in direct sunlight during hot weather, open the windows for a short time to let the hot air inside the vehicle escape.
 - To help reduce moisture inside of windows on rainy humid days, decrease the humidity inside the vehicle by operating the air conditioning system.
 - During air conditioning system operation, you may occasionally notice a slight change in engine speed at idle as the air conditioning compressor cycles on. This is a normal system operation characteristics.
 - Use the air conditioning system every month if only for a few minutes to ensure maximum system performance.
 - When using the air conditioning system, you may notice clear water dripping (or even puddling) on the ground under the passenger side of the vehicle. This is a normal system operation characteristics.
 - The air conditioning system includes a function that automatically turns the air conditioning compressor off if engine coolant temperature approaches an over heating level. The air conditioning compressor operation will resume once engine coolant temperature returns to the normal range. Also, the air conditioning compressor is automatically turned off for a few seconds when the accelerator is fully depressed (wide open throttle).
 - When operating the air conditioning system use the outside (fresh) air position.
 - Operating the air conditioning system in the recirculated air position does provide maximum cooling, however, continual operation in this mode may cause the air inside the vehicle to become stale.

Checking the amount of air conditioner refrigerant and compressor lubricant

When the amount of refrigerant is low, the performance of the air conditioning is reduced. Overfilling also has a bad influence on the air conditioning system.

Therefore, we recommend that the system be inspected by an authorised Kia dealer.

Air conditioner refrigerant and compressor lubricant

CAUTION

The air conditioning system should be serviced by an authorised Kia dealer. Improper service may cause serious injury.

*** NOTICE**

When the performance of the air conditioning system is reduced it is important that the correct type and amount of oil and refrigerant is used. Otherwise, damage to the compressor and abnormal system operation may occur.

1

2

3

4

5

6

7

8

9

WINDSCREEN DEFROSTING AND DEFOGGING

1

2

3

4

5

6

7

8

9

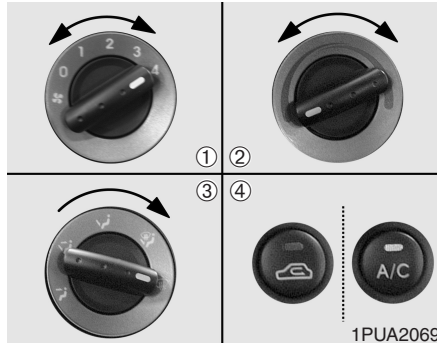

To defog inside windscreen

1. Select any fan speed except “0”.
2. Select desired temperature.
3. Select the or position.
4. The outside (fresh) air and air conditioning will be selected.

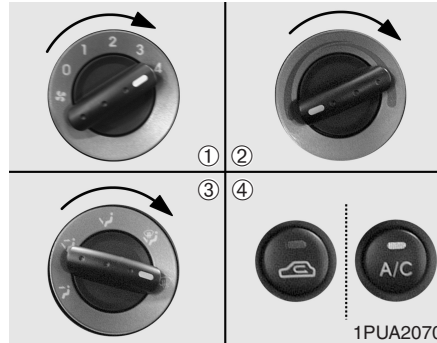

To defrost outside windscreen

1. Set the fan speed to the “3” or “4” position.
2. Set the temperature to the extreme hot position.
3. Select the position.
4. The outside (fresh) air and air conditioning will be selected.





CAUTION



Do not use the or position during cooling operation in extremely humid weather. The difference between the temperature of the outside air and that of the windscreen could cause the outer surface of the windscreen to fog up, causing loss of visibility. In this case, set the mode selection knob to the position and fan speed control knob to the lower speed.

- For maximum defrosting, set the temperature control to the extreme right/hot position and the fan speed control to the highest speed.
- If warm air to the floor is desired whilst defrosting or defogging, set the mode to the floor-defrost position.
- Before driving, clear all snow and ice from the windscreen, rear window, outside rear view mirrors, and all side windows.
- Clear all snow and ice from the bonnet and air inlet in the cowl grill to improve heater and defroster efficiency and to reduce the probability of fogging up inside of the windscreen.

Defogging logic

To reduce the probability of fogging up the inside of the windscreen, the air intake control is set to the outside (fresh) air position automatically if any of following occur.



- The mode is selected to the ,  or  whilst the system is activated.
- The ignition switch is turned on whilst the mode is selected to the  or .

In this case, the air conditioning will automatically operate if the mode is selected to the  or .

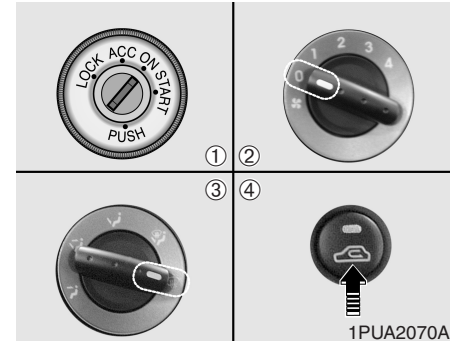
If you don't want the air-conditioning or outside (fresh) air position, press the corresponding button to cancel the operation.



How to cancel or return defogging logic of manual climate control system

1. Turn the ignition switch to the “ON” position.
2. Turn the fan speed control knob to the “0” position.
3. Turn the mode selection knob to the defrost position (.
4. Push the air intake control button () at least 5 times within 3 seconds.



1

Then the indicator light in the air intake control button will blink 3 times with 0.5 second of interval. It indicates that the defogging logic is canceled or returned to the programmed status.

2

3

If the battery has been discharged or disconnected, it is reset as the defog logic status.

4

5

6

7

8

9

Emission control system / 5-2

1

Before driving / 5-3

Suggestions for economical operation / 5-6

2

Special driving conditions / 5-7

Overloading / 5-11

Label information / 5-12

3

Loading Your Vehicle / 5-14

4

Driving tips

5

6

7

8

9

EMISSION CONTROL SYSTEM

The emission control system of your vehicle is covered by a written limited warranty. Please see the warranty information contained in the Warranty & Maintenance book in your vehicle.

1

2

Vehicle modifications

This vehicle should not be modified. Modification of your Kia could affect its performance, safety or durability and may even violate governmental safety and emissions regulations.

3

4

In addition, damage or performance problems resulting from any modification may not be covered under warranty.

5

6

- If you use unauthorised electric devices, it may cause the vehicle to operate abnormally, wire damage, battery discharge and fire. For your safety, do not use unauthorised electric devices.

7

8

9

Engine exhaust gas precautions (carbon monoxide)

⚠ WARNING

Engine exhaust gases contain carbon monoxide (CO). Though colourless and odourless, it is dangerous and could be lethal if inhaled. Follow the instructions following to avoid CO poisoning.

- Carbon monoxide can be present with other exhaust fumes. Therefore, if you smell exhaust fumes of any kind inside your vehicle, we recommend that the system be inspected and repaired by an authorised Kia dealer. If you ever suspect exhaust fumes are coming into your vehicle, drive it only with all the windows fully open. Have your vehicle checked and repaired immediately.
- Do not operate the engine in confined or closed areas (such as garages) any more than what is necessary to move the vehicle in or out of the area.

- When the vehicle is stopped in an open area for more than a short time with the engine running, adjust the ventilation system (as needed) to draw outside air into the vehicle.
- Never sit in a parked or stopped vehicle for any extended time with the engine running.

Operating precautions for catalytic converters (if equipped)

⚠ WARNING - Fire

A hot exhaust system can ignite flammable items under your vehicle. Do not park the vehicle over or near flammable objects, such as dry grass, paper, leaves, etc.

Your vehicle is equipped with a catalytic converter emission control device.

Therefore, the following precautions must be observed:

- Use diesel only.
- Avoid driving with a very low fuel level. Running out of diesel may cause the engine to stop and result in damage to the catalytic converter.
- Do not operate the vehicle when there are signs of engine malfunction, such as misfire or a noticeable loss of performance.

- Do not misuse or abuse the engine. Examples of misuse are coasting with the ignition off and descending steep grades in gear with the ignition off.
- Do not operate the engine at high idle speed for extended periods (5 minutes or more). Avoid idling the engine for periods longer than 10 minutes.
- Do not modify or tamper with any part of the engine or emission control system. All inspections and adjustments must be made by an authorised Kia dealer.

Failure to observe these precautions could result in damage to the catalytic converter and to your vehicle. Additionally, such actions could void your warranties.

Diesel Particulate Filter (if equipped)

The Diesel Particulate Filter (DPF) system removes the soot emitted from the vehicle.

Unlike a disposable air filter, the DPF system automatically burns (oxidizes) and removes the accumulated soot according to the driving condition. In other words, the active burning by engine control system and high exhaust gas temperature caused by normal/high driving condition burns and removes the accumulated soot.

However, if the vehicle continues to be driven at low speed for long time, the accumulated soot may not be automatically removed because of low exhaust gas temperature. In this particular case, the amount of soot is out of detection limit, the soot oxidation process by engine control system may not happen and the malfunction indicator light may blink.

1

2

3

4

5

6

7

8

9

1

When the malfunction indicator light blinks, it may stop blinking by driving the vehicle at more than 60km/h (37 mph) or at more than second gear with 1500 ~ 2000 engine rpm for a certain time (for about 25 minutes).

2

If the malfunction indicator light continues to be blinked in spite of the procedure, we recommend that the system be checked by an authorised Kia dealer.

4

If you continue to drive with the malfunction indicator light blinking for a long time, the DPF system can be damaged and fuel consumption can be worsen.

5

6

7

8

9

**⚠ CAUTION - Diesel Fuel
(if equipped with DPF)**

It is recommended to use the regulated automotive diesel fuel for diesel vehicle equipped with the DPF system.

If you use diesel fuel including high sulfur (more than 50 ppm sulfur) and unspecified additives, it can cause the DPF system to be damaged and white smoke can be emitted.

BEFORE DRIVING

Before entering vehicle:

- Be sure that all windows, outside mirror(s), and outside lights are clean.
- Check the condition of the tyres.
- Check under the vehicle for any sign of leaks.
- Be sure there are no obstacles behind you if you intend to back up.

Necessary inspections

Fluid levels, such as engine oil, engine coolant, brake fluid, and washer fluid should be checked on a regular basis, with the exact interval depending on the fluid. Further details are provided in Section 7, Maintenance.

WARNING

Driving whilst distracted can result in a loss of vehicle control, that may lead to an accident, severe personal injury, and death.

The driver's primary responsibility is in the safe and legal operation of a vehicle, and use of any handheld devices, other equipment, or vehicle systems which take the driver's eyes, attention and focus away from the safe operation of a vehicle or which are not permissible by law should never be used during operation of the vehicle.

Before starting

- Close and lock all doors.
- Position the seat so that all controls are easily reached.
- Adjust the inside and outside rearview mirrors.
- Be sure that all lights work.
- Check all gauges.
- Check the operation of warning lights when the ignition switch is turned to the ON position.
- Release the parking brake and make sure the brake warning light goes out.

For safe operation, be sure you are familiar with your vehicle and its equipment.

WARNING - Driving under the influence of alcohol or drugs

Drinking and driving is dangerous. Drunk driving is the number one contributor to the highway death toll each year. Even a small amount of alcohol will affect your reflexes, perceptions and judgement.

You are much more likely to have a serious accident if you drink and drive.

If you are drinking or taking drugs, don't drive. Do not ride with a driver who has been drinking or taking drugs. Choose a designated driver or call a cab.

Driving whilst under the influence of drugs is as dangerous or more dangerous than driving drunk.

1

2

3

4

5

6

7

8

9

SUGGESTIONS FOR ECONOMICAL OPERATION

Your vehicle's fuel economy depends mainly on your style of driving, where you drive and when you drive.

1

Each of these factors affects how many kilometers (miles) you can get from a litre (gallon) of fuel. To operate your vehicle as economically as possible, use the following driving suggestions to help save money in both fuel and repairs:

2

3

4

5

6

7

8

9

- Avoid lengthy warm-up idling. Once the engine is running smoothly, begin driving. Remember, engine warm-up may take a little longer on cold days.
- Save fuel by accelerating slowly after stopping.
- Keep the engine in tune and follow the recommended periodic maintenance schedule. This will increase the life of all parts and lower your operating costs.

- Do not use the air conditioner unnecessarily.
- Slow down when driving on rough roads.
- For longer tyre life and better fuel economy, always keep the tyres inflated to the recommended pressures.
- Maintain a safe distance from other vehicles to avoid sudden stops. This will reduce wear on brake linings and pads. Driving in such a way will also save fuel because extra fuel is required to accelerate back to driving speed.
- Do not carry unnecessary weight in the vehicle.
- Do not rest your foot on the brake pedal whilst driving. This can cause needless wear, possible damage to the brakes, and poor fuel economy.
- Improper wheel alignment results in faster tyre wear and lower fuel economy.

- Open windows at high speeds can reduce fuel economy.
- Fuel economy is less in crosswinds and headwinds. To help offset some of this loss, slow down when driving in these conditions.

Keeping a vehicle in good operating condition is important both for economy and safety. Therefore, we recommend that the system be serviced by an authorised Kia dealer.

⚠ WARNING - Engine off during motion

Never turn the engine off to coast down hills or anytime the vehicle is in motion. The power steering and power brakes will not function without the engine running. Instead, keep the engine on and downshift to an appropriate gear for engine braking effect.

SPECIAL DRIVING CONDITIONS

Hazardous driving conditions

When hazardous driving conditions are encountered such as water, snow, ice, mud, sand, or similar hazards, follow these suggestions:

- Drive cautiously and allow extra distance for braking.
- Avoid sudden movements in braking or steering.
- When braking, pump the brake pedal with a light up-and-down motion until the vehicle is stopped.
- If stalled in snow, mud, or sand, use second gear. Accelerate slowly to avoid spinning the drive wheels.
- Use sand, rock salt, tyre chains, or other non-slip material under the drive wheels to provide traction when stalled in ice, snow, or mud.

Rocking the vehicle

If it is necessary to rock the vehicle to free it from snow, sand, or mud, first turn the steering wheel right and left to clear the area around your front wheels. Then, shift back and forth between 1 (First) and R (Reverse). Do not race the engine, and spin the wheels as little as possible. If you are still stuck after a few tries, have the vehicle pulled out by a tow vehicle to avoid engine overheating and possible damage to the transmission.

* NOTICE

Prolonged rocking may cause engine overheating, transmission damage or failure, and tyre damage.

⚠ WARNING - Spinning tyres
Do not spin the wheels, especially at speeds more than 56 km/h (35 mph). Spinning the wheels at high speeds when the vehicle is stationary could cause a tyre to overheat, explode and injure bystanders.

1

2

3

4

5

6

7

8

9

1

Driving at night

Because night driving presents more hazards than driving in the daylight, here are some important tips to remember:

2

- Slow down and keep more distance between you and other vehicles, as it may be more difficult to see at night, especially in areas where there may not be any street lights.

3

- Adjust your mirrors to reduce the glare from other driver's headlights.

4

5

- Keep your headlights clean and properly aimed on vehicles not equipped with the automatic headlight aiming feature. Dirty or improperly aimed headlights will make it much more difficult to see at night.

6

7

8

9

- Avoid staring directly at the headlights of oncoming vehicles. You could be temporarily blinded, and it will take several seconds for your eyes to readjust to the darkness.

Driving in the rain

Rain and wet roads can make driving dangerous, especially if you're not prepared for the slick pavement. Here are a few things to consider when driving in the rain:

- A heavy rainfall will make it harder to see and will increase the distance needed to stop your vehicle, so slow down.

- Keep your windscreen wiping equipment in good shape. Replace your windscreen wiper blades when they show signs of streaking or missing areas on the windscreen.

- If your tyres are not in good condition, making a quick stop on wet pavement can cause a skid and possibly lead to an accident. Be sure your tyres are in good shape.

- Turn on your headlights to make it easier for others to see you.

- Driving too fast through large puddles can affect your brakes. If you must go through puddles, try to drive through them slowly.

- If you believe you may have gotten your brakes wet, apply them lightly whilst driving until normal braking operation returns.

Driving in flooded areas

Avoid driving through flooded areas unless you are sure the water is no higher than the bottom of the wheel hub. Drive through any water slowly. Allow adequate stopping distance because brake performance may be affected. After driving through water, dry the brakes by gently applying them several times while the vehicle is moving slowly.

Driving off-road

Drive carefully off-road because your vehicle may be damaged by rocks or roots of trees. Become familiar with the off-road conditions where you are going to drive before you begin driving.

Winter driving

- We recommend that you carry emergency equipment, including tyre chains, a window scraper, windscreen de-icer, a bag of sand or salt, flares, a small shovel and jumper cables.
- Make sure you have sufficient ethylene-glycol coolant in the radiator.
- Check the battery condition and cables. Cold temperatures reduce the capacity of any battery, so it must be in excellent condition to provide enough winter starting power.
- Make sure the engine oil viscosity is suitable for cold weather.
- Check the ignition system for loose connections and damage.
- Use antifreeze-formulated windscreen washer fluid. (Do not use engine coolant antifreeze.)
- Do not use the parking brake if it might freeze. When parking, shift to 1 (First) or R (Reverse) and block the rear wheels.

Snow tyres

If you mount snow tyres on your Kia, make sure they are radial tyres of the same size and load range as the original tyres. Mount snow tyres on all four wheels to balance your vehicle's handling in all weather conditions. Keep in mind that the traction provided by snow tyres on dry roads may not be as high as your vehicle's original equipment tyres. You should drive cautiously even when the roads are clear. Check with the tyre dealer for maximum speed recommendations.

WARNING - Snow tyre size

Snow tyres should be equivalent in size and type to the vehicle's standard tyres. Otherwise, the safety and handling of your vehicle may be adversely affected.

Do not install studded tyres without first checking local, state and municipal regulations for possible restrictions against their use.

Tyre chains

Since the sidewalls of radial tyres are thinner, they can be damaged by mounting some types of snow chains on them. Therefore, the use of snow tyres is recommended instead of snow chains. Do not mount tyre chains on vehicles equipped with aluminum wheels, snow chains may cause damage to the wheels. If snow chains must be used, use wire-type chains with a thickness of less than 15 mm (0.59 in). Damage to your vehicle caused by improper snow chain use is not covered by your vehicle manufacturers warranty.

Install them only on the rear tyres.

1

2

3

4

5

6

7

8

9

1

2

3

4

5

6

7

8

9

* NOTICE

- Make sure the snow chains are the correct size and type for your tyres. Incorrect snow chains can cause damage to the vehicle body and suspension and may not be covered by your vehicle manufacturer warranty. Also, the snow chain connecting hooks may be damaged from contacting vehicle components causing the snow chains to come loose from the tyre. Make sure the snow chains are SAE class “S” certified.
- Always check chain installation for proper mounting after driving approximately 0.5 to 1 km (0.3 to 0.6 miles) to ensure safe mounting. Retighten or remount the chains if they are loose.

Chain installation

When installing chains, follow the manufacturer's instructions and mount them as tightly as you can. Drive slowly with chains installed. If you hear the chains contacting the body or chassis, stop and tighten them. If they still make contact, slow down until it stops. Remove the chains as soon as you begin driving on cleared roads.

WARNING - Mounting chains

When mounting snow chains, park the vehicle on level ground away from traffic. Turn on the vehicle Hazard Warning flashers and place a triangular emergency warning device behind the vehicle if available. Always apply the parking brake and turn off the engine before installing snow chains.

WARNING - Tyre chains

- The use of chains may adversely affect vehicle handling.
- Do not exceed 30 km/h (20 mph) or the chain manufacturer's recommended speed limit, whichever is lower.
- Drive carefully and avoid bumps, holes, sharp turns, and other road hazards, which may cause the vehicle to bounce.
- Avoid sharp turns or locked-wheel braking.
- Chains that are the wrong size or improperly installed can damage your vehicle's brake lines, suspension, body and wheels.
- Stop driving and retighten the chains any time you hear them hitting the vehicle.

OVERLOADING

⚠ CAUTION

The gross axle weight rating (GAWR) and the gross vehicle weight rating (GVWR) for your vehicle are on the manufacturer's label attached to the passenger's door. Exceeding these ratings can cause an accident or vehicle damage. You can calculate the weight of your load by weighing the items (or people) before putting them in the vehicle. Be careful not to overload your vehicle.

1

2

3

4

5

6

7

8

9

LABEL INFORMATION

There are several important labels and identification numbers located on your vehicle. The label locations are identified in the illustrations shown.

1

2

3

4

5

6

7

8

9

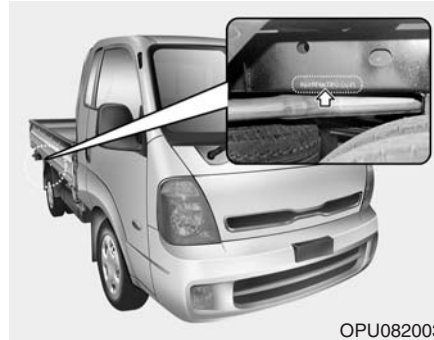

Vehicle identification number (VIN)

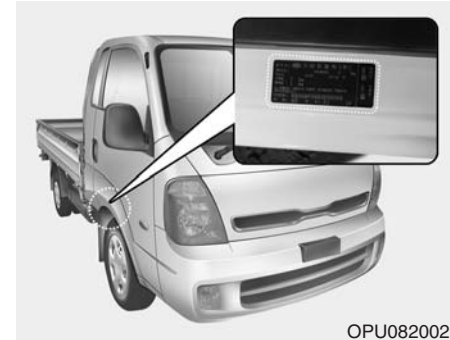

Identification label (if equipped)

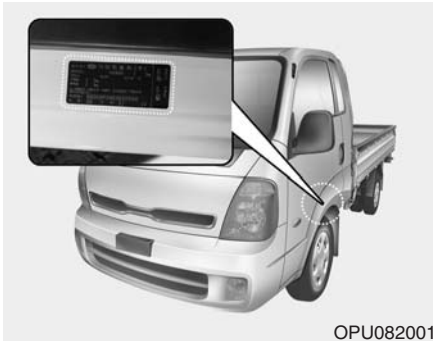

Load sensing proportioning valve (if equipped)

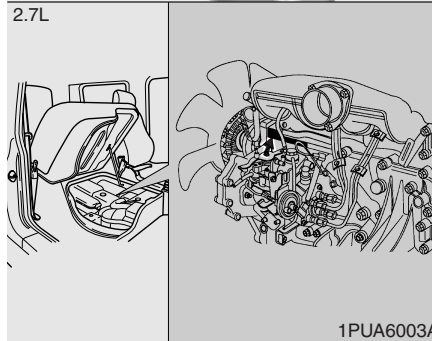
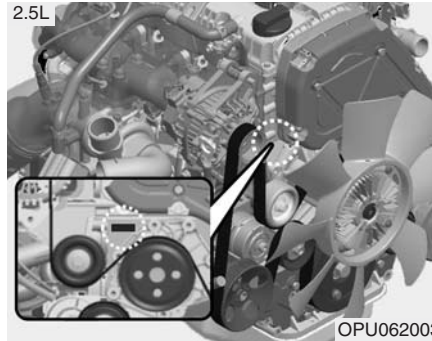

Engine number

- 1
- 2
- 3
- 4
- 5**
- 6
- 7
- 8
- 9

LOADING YOUR VEHICLE (FOR AUSTRALIA ONLY)

1

2

3

4

5

6

7

8

9



1PUR5002

The Certification/Tyre label is found on the B-pillar (right side). The label shows the size of your original tyres and inflation pressures needed to obtain the gross weight capacity of your vehicle.

This is called the GVWR (Gross Vehicle Weight Rating). The GVWR includes the weight of the vehicle, all occupants, fuel and cargo. The Certification/Tyre label also tells you the maximum weights for the front and rear axles, called Gross Axle Weight Rating (GAWR).

Never exceed the GVWR for your vehicle, or the Gross Axle Weight Rating (GAWR) for either the front or rear axle. And, if you do have a heavy load, you should spread it out.

CAUTION

Do not load your vehicle any heavier than the GVWR or the maximum front and rear GAWRs. If you do, change to the vehicle may occur, or it can change the way your vehicle handles. These could cause you to lose control. Also, overloading can shorten the life of your vehicle.

*** NOTICE**

Your warranty does not cover parts or components that fail because of overloading.

Road warning / 6-2

In case of an emergency whilst driving / 6-3

Overheating / 6-4

Emergency starting / 6-5

Electrical circuit protection / 6-7

Towing / 6-14

If you have a flat tyre / 6-18

1

2

3

4

5

In case of an emergency

6

7

8

9

ROAD WARNING



Depress the flasher switch with the ignition switch in any position. The flasher switch is located in the centre console switch panel. All turn signal lights will flash simultaneously.

- The hazard warning flasher operates whether your vehicle is running or not.
- The turn signals do not work when the hazard flasher is on.
- Care must be taken when using the hazard warning flasher whilst the vehicle is being towed.

Hazard warning flasher

The hazard warning flasher serves as a warning to other drivers to exercise extreme caution when approaching, overtaking, or passing your vehicle. It should be used whenever emergency repairs are being made or when the vehicle is stopped near the edge of a roadway.

IN CASE OF AN EMERGENCY WHILST DRIVING

If the engine stalls at a cross-road or crossing

- If the engine stalls at a crossroad or crossing, set the shift lever in the N (Neutral) position and then push the vehicle to a safe place.
- If your vehicle has a manual transaxle not equipped with a ignition lock switch, the vehicle can move forward by shifting to the 2 (second) or 3 (third) gear and then turning the starter without depressing the clutch pedal.

If you have a flat tyre whilst driving

If a tyre goes flat whilst you are driving:

1. Take your foot off the accelerator pedal and let the car slow down whilst driving straight ahead. Do not apply the brakes immediately or attempt to pull off the road as this may cause a loss of control. When the car has slowed to such a speed that it is safe to do so, brake carefully and pull off the road.
Drive off the road as far as possible and park on firm, level ground. If you are on a divided highway, do not park in the median area between the two traffic lanes.
2. When the car is stopped, turn on your emergency hazard flashers, set the parking brake and put the transaxle in P (automatic transaxle) or reverse (manual transaxle).
3. Have all passengers get out of the car. Be sure they all get out on the side of the car that is away from traffic.
4. When changing a flat tyre, follow the instruction provided later in this section.

If engine stalls whilst driving

1. Reduce your speed gradually, keeping a straight line. Move cautiously off the road to a safe place.
2. Turn on your emergency flashers.
3. Try to start the engine again. If your vehicle will not start, we recommend that you consult an authorised Kia dealer.

1

2

3

4

5

6

7

8

9

OVERHEATING

1 If your temperature gauge indicates overheating, if you experience a loss of power, or if you hear a loud knocking or pinging noise, the engine has probably overheated. Should any of these symptoms occur, use the following procedure:

- 2 1. Turn on the hazard warning flasher, then drive to the nearest safe location and stop your vehicle; shift the manual transmission to N (Neutral) and apply the parking brake.
- 3 2. Make sure the air conditioner is off.
- 4 3. If coolant or steam is boiling out of the radiator, we recommend that you contact an authorised Kia dealer.

5 If coolant is not boiling out, allow the engine to idle and lift the seat cushions to permit the engine to cool gradually.

6 If the temperature does not go down with the engine idling, stop the engine and allow sufficient time for it to cool.

- 7 4. The coolant level should then be checked. If the level in the reservoir is low, look for leaks at the radiator hoses and connections, heater hoses and connections, radiator, and water pump. If you find a major leak or another problem that may have caused the engine to overheat, do not operate the engine until it has been corrected. Call an Authorised Kia Dealer for assistance. If you do not find a leak or other problem, carefully add coolant to the reservoir.

WARNING - Removing radiator cap

Do not remove the radiator cap when the engine and radiator are hot. Scalding hot coolant and steam may blow out under pressure. This could cause serious injury.

If overheating happens again, we recommend that you call an authorised Kia dealer.

EMERGENCY STARTING

Jump starting

Jump starting can be dangerous if done incorrectly. Therefore, to avoid harm to yourself or damage to your vehicle or battery. If in doubt, we strongly recommend that you have a competent technician or towing service jump start your vehicle.

* NOTICE

Use only a 12-volt jumper system. You can damage a 12-volt starting motor, ignition system, and other electrical parts beyond repair by use of a 24-volt power supply (either two 12-volt batteries in series or a 24-volt motor generator set).

⚠ WARNING - Battery

Never attempt to check the electrolyte level of the battery as this may cause the battery to rupture or explode causing serious injury.

⚠ WARNING - Battery

- Keep all flames or sparks away from the battery. The battery produces hydrogen gas which may explode if exposed to flame or sparks.
- Do not attempt to jump start the vehicle if the discharged battery is frozen or if the electrolyte level is low; the battery may rupture or explode.
- Do not allow the (+) and (-) jumper cables to touch. It may cause sparks.
- The battery may rupture or explode when you jump start with a low or frozen battery.

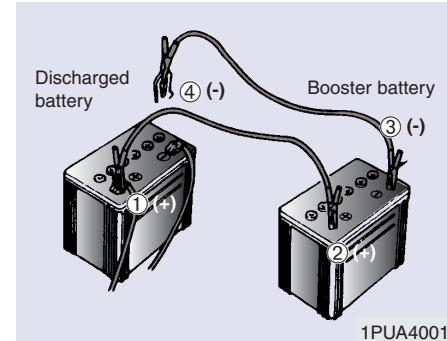

Connecting jumper cables

Connect cables in numerical order and disconnect in reverse order.

- 1
- 2
- 3
- 4
- 5
- 6
- 7
- 8
- 9

Jump starting procedure

1. Make sure the booster battery is 12-volt and that its negative terminal is grounded.
2. If the booster battery is in another vehicle, do not allow the vehicles to touch.
3. Turn off all unnecessary electrical loads.
4. Connect the jumper cables in the exact sequence shown in the previous illustration. First connect one end of a jumper cable to the positive terminal of the discharged battery (①), then connect the other end to the positive terminal on the booster battery (②). Proceed to connect one end of the other jumper cable to the negative terminal of the booster battery (③), then the other end to a solid, stationary, metallic point (for example, the engine lifting bracket) away from the battery (④). Do not connect it to or near any part that moves when the engine is cranked. Do not connect the jumper cable from the negative terminal of the booster battery to the negative terminal of the discharged battery.

Do not allow the jumper cables to contact anything except the correct battery terminals or the correct ground. Do not lean over the battery when making connections.

5. Start the engine of the vehicle with the booster battery and let it run at 2,000 rpm, then start the engine of the vehicle with the discharged battery.

If the cause of your battery discharging is not apparent, we recommend that the system be checked by an authorised Kia dealer.

Push-starting

Your manual transmission-equipped vehicle should not be push-started because it might damage the emission control system.

Follow the directions in this section for jump-starting.

CAUTION

Never tow a vehicle to start it because the sudden surge forward when the engine starts could cause a collision with the tow vehicle.

ELECTRICAL CIRCUIT PROTECTION

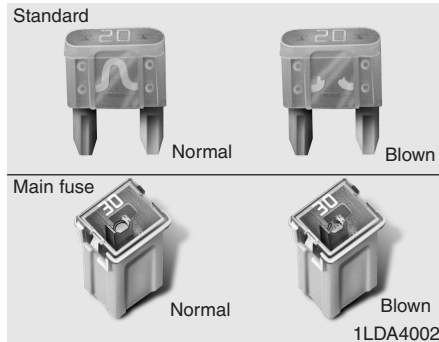

Fuses

A vehicle's electrical system is protected from electrical overload damage by fuses.

This vehicle has two fuse panels, one located in the driver's side knee bolster, the other at frame of the passenger side.

If any of your vehicle's lights, accessories, or controls do not work, check the appropriate circuit fuse. If a fuse has blown, the element inside the fuse will be melted.

If the electrical system does not work, first check the driver's side fuse panel.

Always replace a blown fuse with one of the same rating.

If the replacement fuse blows, this indicates an electrical problem. Avoid using the system involved and we recommend that you consult an authorised Kia dealer.

Two kinds of fuses are used: standard for lower amperage rating and main for higher amperage ratings.

* NOTICE

The actual fuse/relay panel label may differ from equipped items.

Fuse replacement

⚠ WARNING - Fuse replacement

- **Never replace a fuse with anything but another fuse of the same rating.**
- **A higher capacity fuse could cause damage through overheating and possibly a fire.**
- **Never install a wire instead of the proper fuse - even as a temporary repair. It may cause extensive wiring damage and possibly a fire.**
- **Do not use a screwdriver or any other metal object to remove fuses because it may cause a short circuit and damage the system.**

1

2

3

4

5

6

7

8

9

In case of an emergency



If you do not have a spare, use a fuse of the same rating from a circuit you may not need for operating the vehicle, such as the cigar lighter fuse.

If the headlight or other electrical components do not work and the fuses are OK, check the fuse block in the FUSE & RELAY BLOCK. If a fuse is blown, it must be replaced.

Driver-side knee bolster

1. Turn the ignition switch and all other switches off.
2. Pull the suspected fuse straight out. Use the removal tool provided on the fuse panel.
3. Check the removed fuse; replace it if it is blown.

Spare fuses are provided in the fuse & relay block.

4. Push in a new fuse of the same rating, and make sure it fits tightly in the clips.

If it fits loosely, we recommend that you consult an authorised Kia dealer.

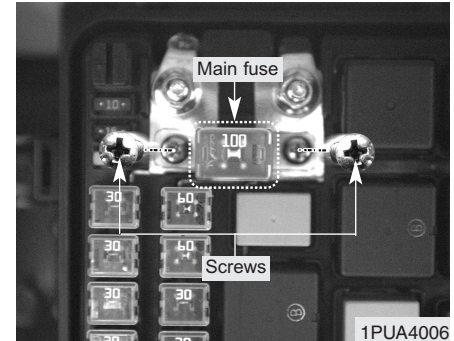

Main fuse (Fuse & relay block)

If the MAIN (100A) fuse is blown, it must be removed as follows:

1. Disconnect the negative battery cable.
2. Remove the main fuse box cover.
3. Remove the screws shown in the picture above.
4. Replace the fuse with a new one of the same rating.
5. Reinstall in the reverse order of removal.

* NOTICE

The main fuse box is located between front tyre and rear tyre on passenger side.

Fuse panel description

Inside the fuse box covers, you can find the fuse label describing fuse name and capacity.

Driver-side knee bolster

Fuse Name	Fuse rating	Protected Component
POWER CONNecTOR (MEMORY)	15A	Instrument Cluster, Heater Control Module, ETACM, Front Room Lamp, Centre Room Lamp (4Door), Door Warning Switch
START	10A	ECM, START Relay
A/BAG IND	10A	Instrument Cluster
A/BAG	15A	SRS Control Module
B/UP LP	10A	Back-Up Lamp Switch, Rear Parking Assist Buzzer
IG 1	15A	ECM, Fuel Filter Warning Sensor, Vehicle Speed Sensor, ABS Control Module, Air Flow Sensor, Fuel Injection Pump, Alternator
CLUSTER	10A	ETACM, Instrument Cluster, Alternator Resister
T/SIG	10A	Hazard Switch
A/CON	10A	Blower Relay, Heater Control Module
MODULE	10A	FOG LP FRT/RR Relay
FUEL HTR	10A	FUEL HTR Relay
WIPER	20A	Wiper Motor, Multifunction Switch (Wiper)
HLLD	10A	Head Lamp Levelling Switch, Head Lamp Levelling Actuator LH/RH
CIGAR LIGHTER	15A	Cigarette Lighter
ACC	10A	Audio

1

2

3

4

5

6

7

8

9

In case of an emergency

	Fuse Name	Fuse rating	Protected Component
1	DR LOCK	20A	ICM Relay Box (Door Lock/Unlock Relay)
2	STOP LAMP	10A	Stop Signal Relay, Data Link Connector
3	HORN	10A	HORN Relay
4	FOG LP RR	10A	FOG LP RR Relay
5	FOG LP FRT	15A	FOG LP FRT Relay
6	LUMBAR SUPPORT	15A	Driver Lumbar Support Switch
7	DRL	10A	DRL Control Module
8	HAZARD	15A	Hazard Switch, ICM Relay Box (Hazard Relay)
9	KEY ILLUMI	10A	Door Warning Switch
	AUDIO	15A	Audio
	TAIL LAMP (LH)	10A	Heater Control Module, Audio, Instrument Cluster, Multifunction Switch, Hazard Switch, Main/Passenger Power Window Switch, Rear Combination Lamp LH, Head Lamp Levelling Switch, AUX & USB Jack, Position Lamp LH, Rear Defogger Switch
	TAIL LAMP (RH)	10A	License Lamp, Rear Combination Lamp RH, Position Lamp RH
	H/LAMP (LH)	15A	Head Lamp LH
	H/LAMP (RH)	15A	Head Lamp RH, Instrument Cluster

Main fuse box (2.5L)

Description	Fuse Name	Fuse rating	Protected Component
FUSIBLE LINK	MAIN	100A	Alternator
	B+ 1	40A	P/WIN Relay, I/P Junction Box (Fuse - DRL, HAZARD)
	BLOWER	30A	Blower Relay
	C/FAN	30A	C/FAN Relay
	FUEL HTR	30A	FUEL HTR Relay
	IG 2	40A	Ignition Switch
	I/C FAN	20A	I/C FAN Relay
	IG 1	40A	Ignition Switch, START Relay
	B+2	40A	I/P Junction Box (TAIL LP Relay, Fuse - TAIL LAMP (LH/RH), LUMBAR SUPPORT, HORN, FOG LP FRT/RR, DR LOCK, STOP LAMP)
	ABS 1	30A	ABS Control Module
	ABS 2	30A	ABS Control Module
	GLOW	60A	GLOW Relay
FUSE	ECU	30A	MAIN Relay
	A/CON	10A	A/CON Relay
	ECU 1	15A	I/C FAN Relay, A/CON Relay, C/FAN Relay, ECM, WGT Solenoid, Stop Lamp Switch, GLOW Relay, Immobilizer Module
	P/PDW (FR)	25A	Main/Passenger Power Window Switch

1

2

3

4

5

6

7

8

9

In case of an emergency

Main fuse box (2.7L)

Description	Fuse Name	Fuse rating	Protected Component
FUSIBLE LINK	MAIN	100A	Alternator
	BTN 1	30A	P/WIN Relay, I/P Junction Box (Fuse - KEY ILLUMI, HAZARD)
	BLOWER	30A	Blower Relay
	COND	20A	COND Relay
	RR HTD	20A	RR HTD Relay
	IGN 2	30A	Ignition Switch
	IGN 1	30A	Ignition Switch, START Relay
	BTN 2	30A	I/P Junction Box (TAIL LP Relay, Fuse - TAIL LAMP (LH/RH), LUMBAR SUPPORT, HORN, FOG LP FRT/RR, DR LOCK, STOP LAMP)
FUSE	GLOW HTR	60A	GLOW Relay
	A/CON	10A	A/CON Relay
	P/WDW (FR)	25A	Main/Passenger Power Window Switch

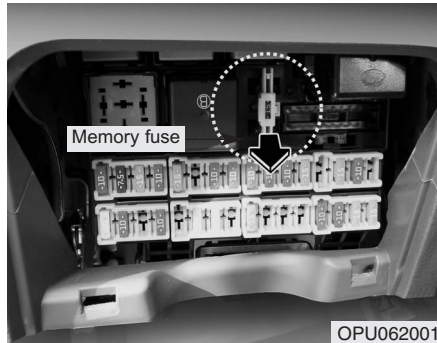

Memory fuse

Your vehicle is equipped with a memory fuse to prevent battery discharge if your vehicle is parked without being operated for prolonged periods. Use the following procedures before parking the vehicle for prolonged period.

1. Turn off the engine.
2. Turn off the headlights and tail lights.
3. Open the driver-side knee bolster cover and pull up the “MEMORY 15A”.

*** NOTICE**

- If the memory fuse is pulled up from the fuse panel, the warning chime, audio, clock and interior lamps, etc., will not operate. Some items must be reset after replacement.
- Even though the memory fuse is pulled up, the battery can still be discharged by operation of the headlights or other electrical devices.

1

2

3

4

5

6

7

8

9

TOWING

1

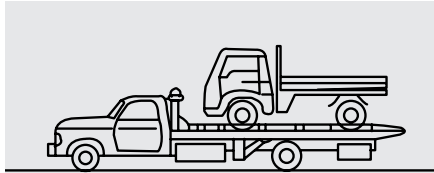

2

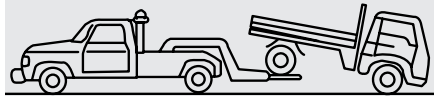

4

1TUA4026

5

6

If emergency towing is necessary, we recommend having it done by an authorised Kia dealer or a commercial tow-truck service. Proper lifting and towing procedures are necessary to prevent damage to the vehicle. The use of wheel dollies or flatbed is recommended.

7

8

9

It is acceptable to tow the vehicle with the front wheels on the ground (without dollies) and the rear wheels off the ground.

When being towed by a commercial tow truck and wheel dollies are not used, the rear of the vehicle should always be lifted, not the front.



1BW4020

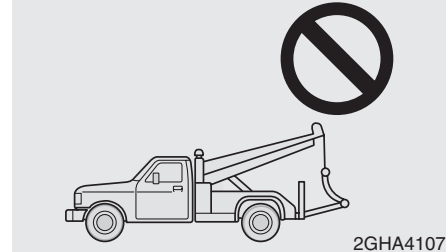

2GHA4107

* NOTICE

- Do not tow the vehicle forward with the rear wheels on the ground as this may cause damage to the vehicle.
- Do not tow with sling-type equipment. Use wheel lift or flatbed equipment.

When towing your vehicle in an emergency without wheel dollies :

1. Set the ignition switch in the ACC position.
2. Place the transmission shift lever in N (Neutral).
3. Release the parking brake.

*** NOTICE**

Failure to place the transmission shift lever in N (Neutral) may cause internal damage to the transmission.

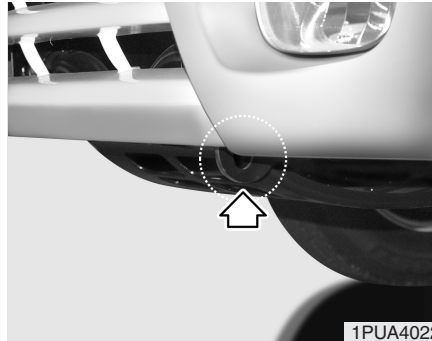

Towing with a vehicle other than a tow truck

If towing is necessary, we recommend you to have it done by an Authorised Kia dealer or a commercial tow truck service.

If towing service is not available in an emergency, your vehicle may be temporarily towed using a cable or chain secured to the emergency towing hook under the front of the vehicle. Use extreme caution when towing the vehicle. A driver must be in the vehicle to steer it and operate the brakes.

Towing in this manner may be done only on hard-surfaced roads for a short distance and at low speeds. Also, the wheels, axles, power train, steering and brakes must all be in good condition.

- Do not use the tow hooks to pull a vehicle out of mud, sand or other conditions from which the vehicle cannot be driven out under its own power.
- Avoid towing a vehicle heavier than the vehicle doing the towing.
- The drivers of both vehicles should communicate with each other frequently.

1
2
3
4
5
6
7
8
9

* NOTICE

- 1 • Attach a towing strap to the tow hook.
- 2 • Using a portion of the vehicle other than the tow hooks for towing may damage the body of your vehicle.
- 3 • Use only a cable or chain specifically intended for use in towing vehicles. Securely fasten the cable or chain to the towing hook provided.
- 4
- 5
- 6 • Before emergency towing, check that the hook is not broken or damaged.
- 7 • Fasten the towing cable or chain securely to the hook.
- 8 • Do not jerk the hook. Apply steady and even force.
- 9 • To avoid damaging the hook, do not pull from the side or at a vertical angle. Always pull straight ahead.

CAUTION

Use extreme caution when towing the vehicle.

- *Avoid sudden starts or erratic driving immobilisers which would place excessive stress on the emergency towing hook and towing cable or chain. The hook and towing cable or chain may break and cause serious injury or damage.*
- *If the towing vehicle can hardly move, do not forcibly continue the towing. We recommend that you contact an authorised Kia dealer.*
- *Tow the vehicle as straight ahead as possible.*
- *Keep away from the vehicle during towing.*

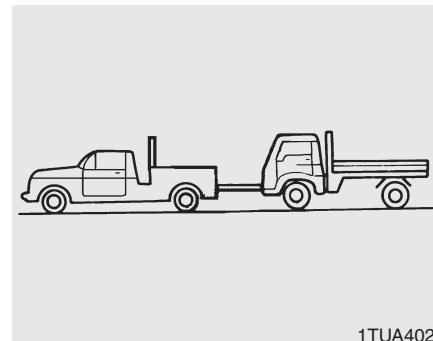

1TUA4029

- Use a towing strap less than 5 m (16 feet) long. Attach a white or red cloth (about 30 cm (12 inches) wide) in the middle of the strap for easy visibility.
- Drive carefully so that the towing strap is not loosened during towing.

When your vehicle is being towed by another vehicle other than a tow truck (in case of an emergency)

- Turn the ignition switch to ACC so the steering wheel isn't locked.
- Place the transmission shift lever in N (Neutral).
- Release the parking brake.

*** NOTICE**

Remove the propeller shaft if it is necessary to exceed 50km/h (31 mph) and/or 25km (16 miles). If the drive shaft cannot be removed, stop every 25km (16 miles) and start the engine. Allow the engine to idle for a few minutes. This will ensure that the transmission is sufficiently lubricated.

- Press the brake pedal with more force than normal since you will have reduced brake performance.
- More steering effort will be required because the power steering system will be disabled.
- If you are driving down a long hill, the brakes may overheat and brake performance will be reduced. Stop often and let the brakes cool off.

*** NOTICE**

To prevent internal damage to the transmission, never tow your vehicle from the rear (backwards) with all four tyres in contact with the surface.

Tips for towing a stuck vehicle

The following methods are effective when your vehicle is stuck in mud, sand or similar substances that prevent the vehicle from being driven out under its own power.

- Remove the soil and sand, etc. from the front and the back of the tyres.
- Place a stone or wood under the tyres.



IF YOU HAVE A FLAT TYRE

1

2

3

4

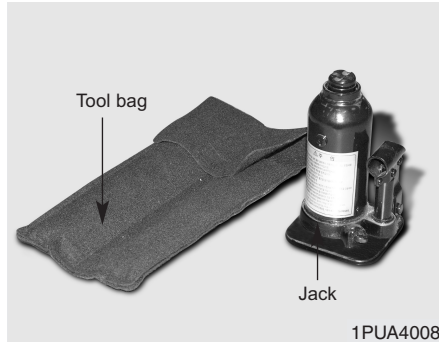

Storing the jack and tools

The jack is stored in the bonnet area and other tools are in the tool bag.

5

6

7

8

9



To remove the jack;

1. Pull down and unhook the rubber band.
 2. Lift the jack carefully.
- After using, replace the jack in the reverse order of removal.

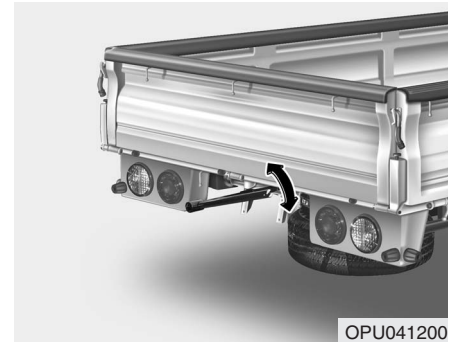

Removing the spare tyre

1. Insert the wheel nut wrench to the spare tyre carrier and insert the wrench lever to the wheel nut wrench.
2. Turn the wheel nut wrench counterclockwise, and the spare tyre comes down.

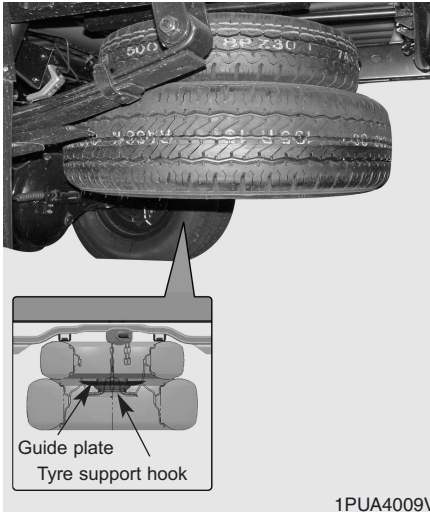

Reinstalling the spare tyre

1. Reinstall the front spare tyre and guide plate on the tyre support hook.
2. Align the stopper bracket on the support hook with the slots in the guide plate and turn the support hook.
3. Reinstall the rear spare tyre on the front spare tyre as illustration.
4. Connect the steel wire with the tyre support hook.
5. Turn the wheel nut wrench clockwise.

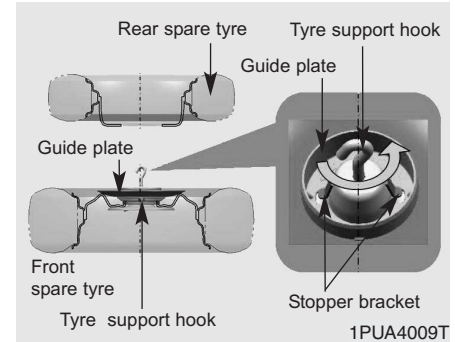

* NOTICE

To prevent the spare tyre rattling whilst the vehicle is in motion, make sure it is snug and secure against the frame.

3. Disconnect the steel wire from the tyre support hook after the spare tyre comes down completely.
4. Remove the rear spare tyre.
5. Remove the guide plate by turning the tyre support hook.



Changing tyres

Jacking instructions

1

The jack is provided for emergency tyre changing only.

2

Follow jacking instructions to reduce the possibility of personal injury.

3

4

5

6

7

8

9

⚠ WARNING - Changing tyres

- **Never attempt vehicle repairs in the traffic lanes of a public road or highway.**
- **Always move the vehicle completely off the road and onto the shoulder before trying to change a tyre. The jack should be used on level firm ground. If you cannot find a firm, level place off the road, call a towing service company for assistance.**
- **Be sure to use the correct front and rear jacking positions on the vehicle; never use the bumpers or any other part of the vehicle for jacking support.**
- **The vehicle can easily roll off the jack causing serious injury or death.**
- **Do not get under a vehicle that is supported by a jack.**

(Continued)

(Continued)

- **Do not start or run the engine while the vehicle is on the jack.**
- **Do not allow anyone to remain in the vehicle while it is on the jack.**
- **Make sure any children present are in a secure place away from the road and from the vehicle to be raised with the jack.**

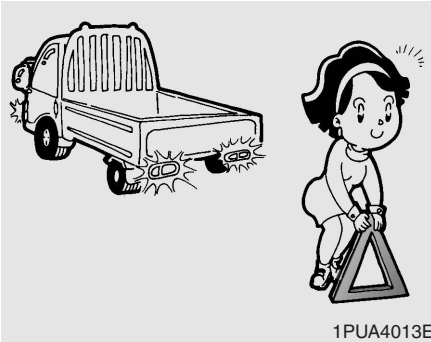

Tyre replacement

1. Park on a level surface and apply the parking brake firmly.
2. Shift the shift lever into R (Reverse).
3. Activate the hazard warning flasher.

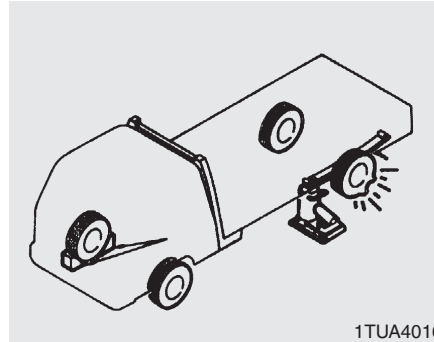

4. Remove the wheel lug nut wrench, jack, jack handle, and spare tyre from the vehicle.
5. Block both the front and rear of the wheel that is diagonally opposite the jack position.

⚠ WARNING - Changing a tyre

- To prevent vehicle movement whilst changing a tyre, always set the parking brake fully, and always block the wheel diagonally opposite the wheel being changed.
- It is recommended that the wheels of the vehicle be chocked, and that no person should remain in a vehicle that is being jacked.

1
2
3
4
5
6
7
8
9

1

2

3

4

5

6

7

8

9

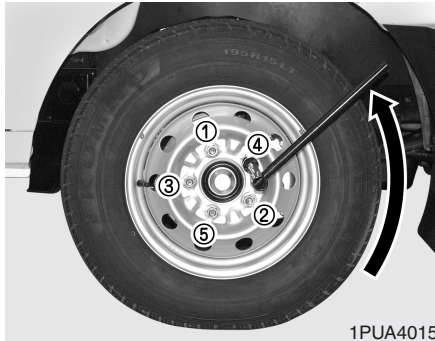

6. Insert the screwdriver into the groove of the wheel cover and pry gently to remove the wheel cover (if equipped).
7. Loosen the wheel lug nuts counterclockwise one turn each, but do not remove any nut until the tyre has been raised off the ground.

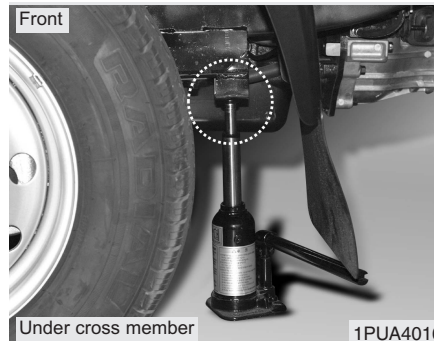

8. Place the jack at the front or rear jacking position closest to the tyre you are changing. Place the jack as shown in the illustration.

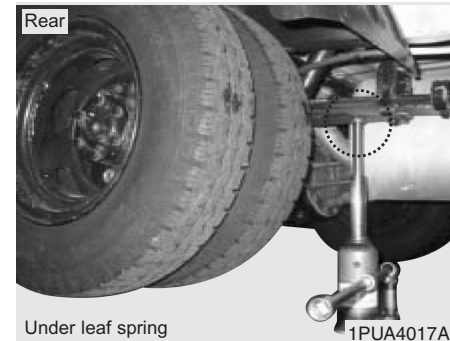

⚠ WARNING - Jack location
To reduce the possibility of injury, be sure to use only the jack provided with the vehicle and in the correct jack position; never use any other part of the vehicle for jack support.

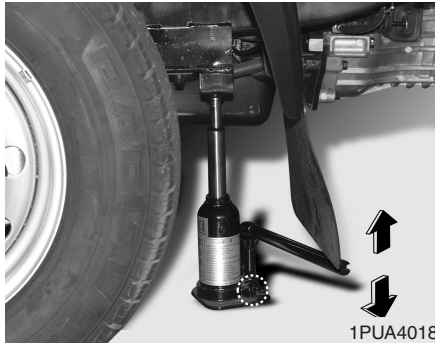

CAUTION

This jack is hydraulic, and the ram is a two-stage type. When both rams are raised and the “stop mark” of the upper ram becomes visible, stop jacking immediately.

9. Securely tighten the valve of the jack with the groove on the jack.
10. Move the jack handle up and down until the top of the jack contacts the proper point and takes on a slight load, raising the vehicle until the tyre just clears the ground. This measurement is approximately 30 mm (1.2 in). Before removing the wheel lug nuts, make sure the vehicle is stable and that there is no chance for movement or slippage.



11. Remove the wheel lug nuts by turning them counterclockwise, then remove the wheel.
12. Mount the spare tyre into position and install the wheel lug nuts with the beveled edge inward.
13. Gradually loosen the valve of the jack with the groove on the jack handle to lower the vehicle.

*** NOTICE**

If the valve is loosened by turning it 2 or more times in the counterclockwise direction, the jack’s oil will leak and the jack cannot be used.

- 1
- 2
- 3
- 4
- 5
- 6
- 7
- 8
- 9

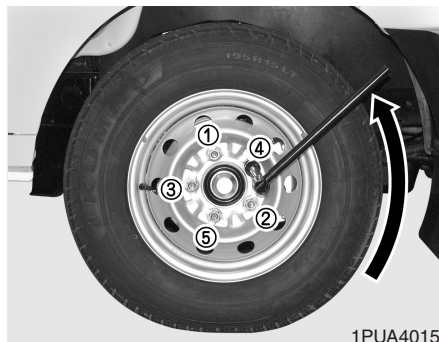

Tightening torque

Item		Front kg·m (lb·ft, N·m)	Rear kg·m (lb·ft, N·m)
Long Body	Standard cab	9~12 (65~87, 88~118)	19~22 (137~159, 186~216)
Extra Long Body			
Long Body (High deck)	Standard cab	19~22 (137~159, 186~216)	19~22 (137~159, 186~216)

14. Once the wheel lug nuts have been tightened, lower the vehicle fully to the ground and continue to tighten the lug nuts until they are fully secured. Tighten the wheel lug nuts firmly in a “*” pattern.

If you are unsure of the tightness of the wheel lug nuts, have them checked at the nearest service station. Improperly tightened wheel lug nuts could cause brake pedal vibration whilst braking.

⚡ CAUTION

Your vehicle has metric threads on the wheel studs and nuts. Make certain during wheel removal that the same nuts removed are reinstalled - or, if replaced, that nuts with metric threads and the same chamfer configuration are used. Installation of a non-metric thread nut on a metric stud or vice-versa will not secure the wheel to the hub properly and will damage the stud so that it must be replaced.

Note that most lug nuts do not have metric threads. Be sure to use extreme care in checking for thread style before installing aftermarket lug nuts or wheels. If in doubt, we recommend that you consult an authorised Kia dealer.

⚠ WARNING - Wheel studs

If the studs are damaged, they may lose their ability to retain the wheel. This could lead to the loss of the wheel and a collision.

To prevent the jack, jack handle, wheel lug nut wrench and spare tyre from rattling whilst the vehicle is in motion, store them properly.

⚠ WARNING

Check the inflation pressures as soon as possible after installing the spare tyre. Adjust it to the specified pressure, if necessary. Refer to Section 8, Specifications.

1

2

3

4

5

6

7

8

9

Maintenance services / 7-3
Normal maintenance schedule / 7-5
Maintenance under severe usage conditions / 7-11
Owner maintenance / 7-15
Engine compartment / 7-18
Engine oil and oil filter / 7-20
Engine cooling system / 7-22
Brakes and clutch / 7-25
Parking brake / 7-26
Power steering / 7-27
Steering wheel / 7-28
Lubricants and fluids / 7-29
Fuel filter / 7-30
Air cleaner / 7-32
Dust filter / 7-33

1

2

3

4

5

6

Maintenance

7

Wiper blades / 7-34
Battery / 7-36
Tyres and wheels / 7-40

8

9

1

Bulb replacement / 7-48
Lubricant specifications / 7-54
Exterior care / 7-56
Interior care / 7-60

2

3

4

5

6

7

Maintenance

8

9

MAINTENANCE SERVICES

You should exercise the utmost care to prevent damage to your vehicle and injury to yourself whenever performing any maintenance or inspection procedures.

Inadequate, incomplete or insufficient servicing may result in operational problems with your vehicle that could lead to vehicle damage, an accident, or personal injury.

Owner's responsibility

* NOTICE

Maintenance Service and Record Retention are the owner's responsibility.

You should retain documents that show proper maintenance has been performed on your vehicle in accordance with the scheduled maintenance service charts shown on the following pages. You need this information to establish your compliance with the servicing and maintenance requirements of your Kia warranties.

Detailed warranty information is provided in your Warranty & Maintenance book.

Repairs and adjustments required as a result of improper maintenance or a lack of required maintenance are not covered.

We recommend you have your vehicle maintained and repaired by an Authorised Kia Dealer. An Authorised Kia Dealer meets Kia's high service quality standards and receives technical support from Kia in order to provide you with a high level of service satisfaction.

CAUTION

- **Do not put heavy objects or apply excessive force on top of the engine cover (if equipped) or fuel related parts.**
- **When you inspect the fuel system (fuel lines and fuel injection devices), we recommend that you contact an authorized Kia dealer.**

(Continued)

(Continued)

- **Do not drive long time with the engine cover (if equipped) removed.**
- **When checking the engine room, do not go near fire. Fuel, washer fluid, etc. are flammable oils that may cause fire.**
- **Before touching the battery, ignition cables and electrical wiring, you should disconnect the battery "-" terminal. You may get an electric shock from the electric current.**
- **When you remove the interior trim cover with a flat bed (-) driver, be careful not to damage the cover.**
- **Be careful when you replace and clean bulbs to avoid burns or electrical shock.**

1

2

3

4

5

6

7

8

9

Scheduled maintenance service

1

Follow Normal Maintenance Schedule if the vehicle is usually operated where none of the following conditions apply. If any of the following conditions apply, follow Maintenance Under Severe Usage Conditions.

2

3

4

5

6

7

8

9

- Repeated short distance driving.
- Driving in dusty conditions or sandy areas.
- Extensive use of brakes.
- Driving in areas where salt or other corrosive materials are being used.
- Driving on rough or muddy roads.
- Driving in mountainous areas.
- Extended periods of idling or low speed operation.
- Driving for a prolonged period in cold temperatures and/or extremely humid climates.
- More than 50% driving in heavy city traffic during hot weather above 32°C (90°F).

If your vehicle is operated under the above conditions, you should inspect, replace or refill more frequently than the following Normal Maintenance Schedule. After 54 month or 90,000 km (54,000 miles) continue to follow the prescribed maintenance intervals.

NORMAL MAINTENANCE SCHEDULE - FOR AUSTRALIA

MAINTENANCE ITEM	MAINTENANCE INTERVALS	Number of months or driving distance, whichever comes first										
		Months	-	6	12	18	24	30	36	42	48	54
		Miles×1,000	0.6	6	12	18	24	30	36	42	48	54
		Km×1,000	1	10	20	30	40	50	60	70	80	90
Drive belts ^{*1}					I			I			I	
Engine oil and engine oil filter	2.5L	Replace every 15,000 km (9,500 miles) or 12 months										
Air cleaner element		Clean every 15,000 km (10,000 miles) or 12 months and replace every 45,000 km (30,000 miles) or 36 months										
Fuel filter						R				R		
Fuel lines and hoses		I		I		I		I		I		

I : Inspect and if necessary, adjust, correct, clean or replace.

R : Replace or change.

^{*1} : Adjust alternator and power steering (and water pump drive belt) and air conditioner drive belt (if equipped).
Inspect and if necessary correct or replace.



NORMAL MAINTENANCE SCHEDULE - FOR AUSTRALIA (CONT.)

1 2 3 4 5 6 7 8 9	MAINTENANCE INTERVALS	Number of months or driving distance, whichever comes first										
		Months	-	6	12	18	24	30	36	42	48	54
		Miles×1,000	0.6	6	12	18	24	30	36	42	48	54
		Km×1,000	1	10	20	30	40	50	60	70	80	90
2	Cooling system	Inspect "Coolant level adjustment and leak" every day										
3	Engine coolant ²	At first, replace every 200,000 km (120,000 miles) or 10 years: after that, replace every 40,000 km (25,000 miles) or 24 months										
4	Battery condition		I	I	I	I	I	I	I	I	I	
	All electrical systems			I		I		I		I		
5	Brake lines, hoses and connections			I		I		I		I		
	Brake pedal, clutch pedal		I	I	I	I	I	I	I	I	I	
6	Parking brake		A	A	A	A	A	A	A	A	A	
	Brake/clutch fluid		I	I	I	R	I	I	I	R	I	
7	Disc brakes and pads		I	I	I	I	I	I	I	I	I	
	Drum brakes and linings		I	I	I	I	I	I	I	I	I	
8	Power steering fluid and hoses (if equipped)		I	I	I	I	I	I	I	I	I	

I : Inspect and if necessary, adjust, correct, clean or replace.

R : Replace or change.

A : Adjustment

² : When adding coolant, use only deionized water or soft water for your vehicle and never mix hard water in the coolant filled at the factory. An improper coolant mixture can result in serious malfunction or engine damage.

NORMAL MAINTENANCE SCHEDULE - FOR AUSTRALIA (CONT.)

MAINTENANCE ITEM	MAINTENANCE INTERVALS	Number of months or driving distance, whichever comes first										
		Months	-	6	12	18	24	30	36	42	48	54
		Miles×1,000	0.6	6	12	18	24	30	36	42	48	54
		Km×1,000	1	10	20	30	40	50	60	70	80	90
Steering gear rack, linkage and boots												
Drive shaft and boots												
Tyre (pressure & tread wear)												
Front suspension												
Leaf spring U-bolt ³												
Bolt and nuts on chassis and body												
Front & rear wheel bearing play ⁴												
Dust filter												
Air conditioner refrigerant (if equipped)												
Air conditioner compressor (if equipped)												
Manual transmission fluid												
Rear differential fluid						R				R		

I : Inspect and if necessary, adjust, correct, clean or replace.

R : Replace or change.

³ : Adjust and tighten the leaf spring U-bolt at first 1,000 km (600 miles) after replacing the leaf spring or U-bolt.

⁴ : Add the wheel bearing grease depending on the condition.

1

2

3

4

5

6

7

8

9

NORMAL MAINTENANCE SCHEDULE - EXCEPT AUSTRALIA

MAINTENANCE INTERVALS		Number of months or driving distance, whichever comes first									
		Months	-	6	12	18	24	30	36	42	48
1 MAINTENANCE ITEM	Miles×1,000	0.6	6	12	18	24	30	36	42	48	54
	Km×1,000	1	10	20	30	40	50	60	70	80	90
	Drive belts ^{*1}	2.5L				I			I		
		2.7L	I	I	I	I	I	I	I	I	I
3 Engine oil and engine oil filter	2.5L	For New Zealand	Replace every 15,000 km (9,500 miles) or 12 months								
		Other contries	Replace every 10,000 km (6,500 miles) or 12 months								
	2.7L	Replace every 5,000 km (3,000 miles) or 6 months									
5 Air cleaner element	Clean every 15,000 km (10,000 miles) or 12 months and replace every 45,000 km (30,000 miles) or 36 months										
6 Valve clearance	2.7L			I		I		I		I	
6 Vapour hose and fuel filler cap	2.7L				I			I			I
6 Vacuum and crankcase ventilation hoses	2.7L				I			I			I
7 Fuel filter						R				R	
7 Fuel lines and hoses		I		I		I		I		I	

I : Inspect and if necessary, adjust, correct, clean or replace. R : Replace or change.

*1 : Adjust alternator and power steering (and water pump drive belt) and air conditioner drive belt (if equipped). Inspect and if necessary correct or replace.

NORMAL MAINTENANCE SCHEDULE - EXCEPT AUSTRALIA (CONT.)

MAINTENANCE ITEM	MAINTENANCE INTERVALS	Number of months or driving distance, whichever comes first										
		Months	-	6	12	18	24	30	36	42	48	54
		Miles×1,000	0.6	6	12	18	24	30	36	42	48	54
		Km×1,000	1	10	20	30	40	50	60	70	80	90
Cooling system		Inspect "Coolant level adjustment and leak" every day										
Engine coolant ²	For New Zealand	At first, replace at 210,000 km (120,000 miles) or 10 years: after that, replace every 30,000 km (20,000 miles) or 24 months										
	Other contries	At first, replace every 200,000 km (120,000 miles) or 10 years: after that, replace every 40,000 km (25,000 miles) or 24 months										
Battery condition			I	I	I	I	I	I	I	I	I	
All electrical systems				I			I			I		
Brake lines, hoses and connections				I			I			I		
Brake pedal, clutch pedal			I	I	I	I	I	I	I	I	I	
Parking brake			I	I	I	I	I	I	I	I	I	
Brake/clutch fluid			I	I	I	I	I	I	I	I	I	
Disc brakes and pads			I	I	I	I	I	I	I	I	I	
Drum brakes and linings			I	I	I	I	I	I	I	I	I	
Power steering fluid and hoses (if equipped)			I	I	I	I	I	I	I	I	I	

I : Inspect and if necessary, adjust, correct, clean or replace. R : Replace or change.

² : When adding coolant, use only deionized water or soft water for your vehicle and never mix hard water in the coolant filled at the factory. An improper coolant mixture can result in serious malfunction or engine damage.

- 1
- 2
- 3
- 4
- 5
- 6
- 7
- 8
- 9

NORMAL MAINTENANCE SCHEDULE - EXCEPT AUSTRALIA (CONT.)

1 2 3 4 5 6 7	MAINTENANCE INTERVALS	Number of months or driving distance, whichever comes first										
		Months	-	6	12	18	24	30	36	42	48	54
		Miles×1,000	0.6	6	12	18	24	30	36	42	48	54
		Km×1,000	1	10	20	30	40	50	60	70	80	90
8	Steering gear rack, linkage and boots		I	I	I	I	I	I	I	I	I	
	Drive shaft and boots		I	I	I	I	I	I	I	I	I	
	Tyre (pressure & tread wear)		I	I	I	I	I	I	I	I	I	
	Front suspension		I	I	I	I	I	I	I	I	I	
	Leaf spring U-bolt ³		I	I	I	I	I	I	I	I	I	
	Bolt and nuts on chassis and body		I	I	I	I	I	I	I	I	I	
	Front & rear wheel bearing play ⁴		I	I	I	I	I	I	I	I	I	
	Dust filter			I		I		I		I		
	Air conditioner refrigerant (if equipped)		I	I	I	I	I	I	I	I	I	
	Air conditioner compressor (if equipped)		I	I	I	I	I	I	I	I	I	
	Manual transmission fluid							I				
	Rear differential fluid			I		R		I		R		

I : Inspect and if necessary, adjust, correct, clean or replace.

R : Replace or change.

³ : Adjust and tighten the leaf spring U-bolt at first 1,000 km (600 miles) after replacing the leaf spring or U-bolt.

⁴ : Add the wheel bearing grease depending on the condition.

MAINTENANCE UNDER SEVERE USAGE CONDITIONS - FOR AUSTRALIA

The following items must be serviced more frequently on cars mainly used under severe driving conditions. Refer to the chart below for the appropriate maintenance intervals.

R : Replace I : Inspect and if necessary, adjust, correct, clean or replace

MAINTENANCE ITEM		Maintenance operation	Maintenance intervals	Driving condition
Engine oil and engine oil filter	2.5L	R	Every 7,500 km (4,500 miles) or 6 months	A, B, C, D, F, G, H, I, J
Air cleaner element		I or R	Clean every time engine oil replaces Replace every 10,000 km (6,000 miles)	C, E
Manual transmission fluid		R	Every 120,000 km (75,000 miles)	A, C, E, F, G, H, I, J
Rear differential fluid		I or R	Every 10,000 km (6,000 miles)	C, F, G, H, I
Steering gear rack, linkage and boots		I	Inspect more frequently depending on the condition	C, D, E, F, G
Front suspension		I	Inspect more frequently depending on the condition	C, D, E, F, G

1

2

3

4

5

6

7

8

9

Maintenance

	MAINTENANCE ITEM	Maintenance operation	Maintenance intervals	Driving condition
1	Disc brakes and pads, calipers and rotors	I	Inspect more frequently depending on the condition	C, D, E, G, H
2	Drum brakes and linings	I	Inspect more frequently depending on the condition	C, D, E, G, H
3	Parking brake	I	Inspect more frequently depending on the condition	C, D, G, H
4	Drive shaft and boots	I	Inspect more frequently depending on the condition	C, D, E, F
5	Dust filter	I	Every 10,000 km (6,000 miles)	C, E

6

Severe driving conditions

7

A : Repeated short distance driving

B : Extensive idling

C : Driving in dusty, rough roads

D : Driving in areas using salt or other corrosive materials or in very cold weather

E : Driving in sandy areas

F : More than 50 % driving in heavy city traffic during hot weather above 32°C (90°F)

G : Driving in mountainous areas

H : Towing a trailer

I : Driving for patrol car, taxi, commercial car or vehicle towing

J : Driving over 170 km/h (106 MPH)

8

9

MAINTENANCE UNDER SEVERE USAGE CONDITIONS - EXCEPT AUSTRALIA

The following items must be serviced more frequently on cars mainly used under severe driving conditions. Refer to the chart below for the appropriate maintenance intervals.

R : Replace I : Inspect and if necessary, adjust, correct, clean or replace

MAINTENANCE ITEM		Maintenance operation	Maintenance intervals	Driving condition
Engine oil and engine oil filter	2.5L	R	<ul style="list-style-type: none"> • For New Zealand Every 7,500 km (4,500 miles) or 6 months • Other countries Every 5,000 km (3,000 miles) or 6 months 	A, B, C, D, F, G, H, I, J
	2.7L	R	<ul style="list-style-type: none"> • For New Zealand, South Africa Every 4,000 km (2,500 miles) or 6 months • Other countries Every 3,000 km (2,000 miles) or 6 months 	A, B, C, D, F, G, H, I, K
Air cleaner element		I or R	Clean every 1,500 km (900 miles) and replace every 10,000 km (6,000 miles)	C, E
Manual transmission fluid		R	Every 100,000 km (60,000 miles)	A, C, E, F, G, H, I, J
Rear differential fluid		I or R	Every 10,000 km (6,000 miles)	C, F, G, H, I

1

2

3

4

5

6

7

8

9

Maintenance

	MAINTENANCE ITEM	Maintenance operation	Maintenance intervals	Driving condition
1	Steering gear rack, linkage and boots	I	Inspect more frequently depending on the condition	C, D, E, F, G
2	Front suspension	I	Inspect more frequently depending on the condition	C, D, E, F, G
3	Disc brakes and pads, calipers and rotors	I	Inspect more frequently depending on the condition	C, D, E, G, H
4	Drum brakes and linings	I	Inspect more frequently depending on the condition	C, D, E, G, H
5	Parking brake	I	Inspect more frequently depending on the condition	C, D, G, H
6	Drive shaft and boots	I	Inspect more frequently depending on the condition	C, D, E, F
7	Dust filter	I	Every 10,000 km (6,000 miles)	C, E

8 Severe driving conditions

A : Repeated short distance driving
 B : Extensive idling
 C : Driving in dusty, rough roads
 D : Driving in areas using salt or other corrosive materials or in very cold weather
 E : Driving in sandy areas

F : More than 50 % driving in heavy city traffic during hot weather above 32°C (90°F)
 G : Driving in mountainous areas
 H : Towing a trailer
 I : Driving for patrol car, taxi, commercial car or vehicle towing
 J : Driving over 170 km/h (106 MPH)
 K : Driving over 140 km/h (85 MPH)

OWNER MAINTENANCE

Owner maintenance schedule

The following lists are vehicle checks and inspections that should be performed at the frequencies indicated to help ensure safe, dependable operation of your vehicle.

Any adverse conditions should be brought to the attention of your dealer as soon as possible.

These Owner Maintenance Checks are generally not covered by warranties and you may be charged for labor, parts and lubricants used.

When you stop for fuel:

- Check the engine oil level.
- Check coolant level in coolant reservoir.

⚠ WARNING

Be careful when checking your engine coolant level when the engine is hot. Scalding hot coolant and steam may blow out under pressure. This could cause serious injury.

- Check the windscreen washer fluid level.
- Look for low or under-inflated tyres.

Whilst operating your vehicle:

- Note any changes in the sound of the exhaust or any smell of exhaust fumes in the vehicle.
- Check for vibrations in the steering wheel. Notice any increased steering effort or looseness in the steering wheel, or change in its straight-ahead position.
- Notice if your vehicle constantly turns slightly or “pulls” to one side when travelling on smooth, level road.
- When stopping, listen and check for strange sounds, pulling to one side, increased brake pedal travel or “hard-to-push” brake pedal.
- If any slipping or changes in the operation of your transmission occurs, check the transmission fluid level.
- Check parking brake.
- Check for fluid leaks under your vehicle (water dripping from the air conditioning system after use is normal).

1

2

3

4

5

6

7

8

9

1

At least monthly:

- Check coolant level in the coolant recovery reservoir.
- Check the operation of all exterior lights, including the stoplights, turn signals and hazard warning flashers.
- Check the inflation pressures of all tyres including the spare.

2

3

4

5

6

7

8

9

At least twice a year (i.e., every Spring and Fall) :

- Check radiator, heater and air conditioning hoses for leaks or damage.
- Check windscreen washer spray and wiper operation. Clean wiper blades with clean cloth dampened with washer fluid.
- Check headlight alignment.
- Check muffler, exhaust pipes, shields and clamps.
- Check the lap/shoulder belts for wear and function.
- Check for worn tyres and loose wheel lug nuts.

At least once a year :

- Clean body and door drain holes.
- Lubricate door hinges and checks, and bonnet hinges.
- Lubricate door and bonnet locks and latches.
- Lubricate door rubber weatherstrips.
- Check the air conditioning system before the warm weather season.
- Check the power steering fluid level.
- Clean battery and terminals.
- Check the brake fluid level.

Owner maintenance precautions

Improper or incomplete service may result in problems. This section gives instructions only for the maintenance items that are easy to perform.

* NOTICE

Improper owner maintenance during the warranty period may affect warranty coverage. For details, read the separate **Kia Warranty & Maintenance** book provided with the vehicle. If you're unsure about any servicing or maintenance procedure, we recommend that the system be serviced by an authorised Kia dealer.

⚠ WARNING - Maintenance work

- **Performing maintenance work on a vehicle can be dangerous. You can be seriously injured whilst performing some maintenance procedures. If you lack sufficient knowledge and experience or the proper tools and equipment to do the work, we recommend that the system be serviced by an authorised Kia dealer.**
- **Working in the engine room with the engine running is dangerous. It becomes even more dangerous when you wear jewelry or loose clothing. These can become entangled in moving parts and result in injury. Therefore, if you must run the engine whilst working in the engine room, make certain that you remove all jewelry (especially rings, bracelets, watches, and necklaces) and all neckties, scarves, and similar loose clothing before getting near the engine or cooling fans.**

1

2

3

4

5

6

7

8

9

ENGINE COMPARTMENT

■ 2.5L Engine

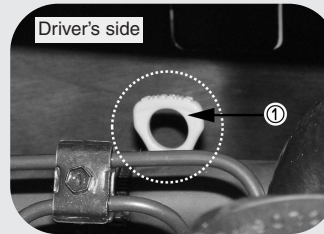
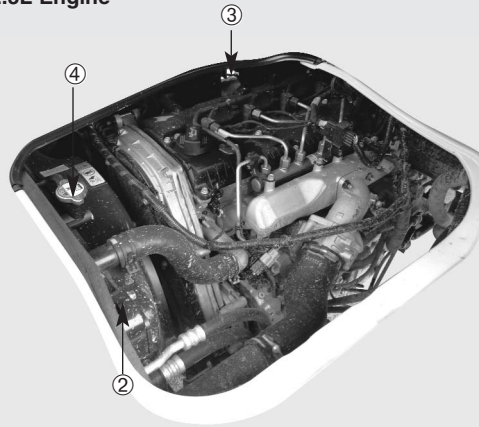

1. Engine oil dipstick
2. Power steering fluid reservoir (if equipped)
3. Engine oil filler cap
4. Radiator cap
5. Dust filter
6. Engine coolant reservoir
7. Windscreen washer fluid reservoir

Bonnet



* The actual engine room in the vehicle may differ from the illustration.

OPU072301/1PUB7002/1PUB7003

■ 2.7L Engine

Passenger's side

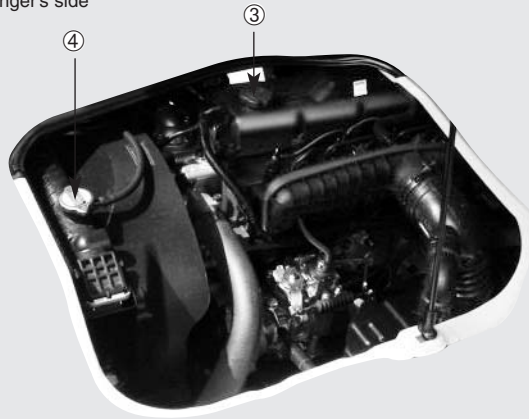

Driver's side

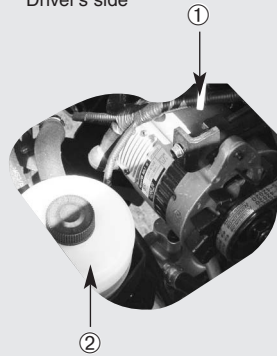

1. Engine oil dipstick
2. Power steering fluid reservoir (if equipped)
3. Engine oil filler cap
4. Radiator cap
5. Dust filter
6. Engine coolant reservoir
7. Windscreen washer fluid reservoir

Bonnet



* The actual engine room in the vehicle may differ from the illustration.

1PUR7001/1PUR7002/1PUB7003



ENGINE OIL AND OIL FILTER

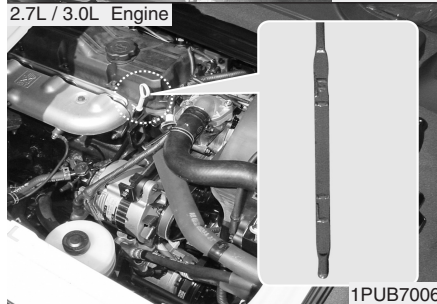
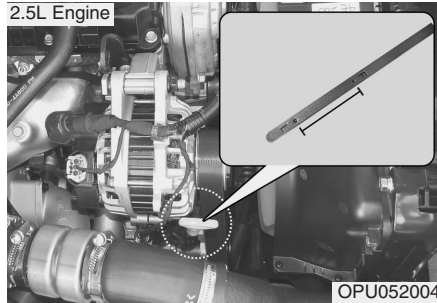

Checking the engine oil level

1. Be sure the vehicle is on level ground.

2. Start the engine and allow it to reach normal operating temperature.
3. Turn the engine off and wait for a whilst (at least 10 minutes) for the oil to return to the oil pan.
4. Pull the dipstick out, wipe it clean, and re-insert it fully.
5. Pull the dipstick out again and check the level. The level should be between F and L.

* NOTICE

The engine oil dipstick is located below driver's side seat. Refer to the engine room access / driver's seat.

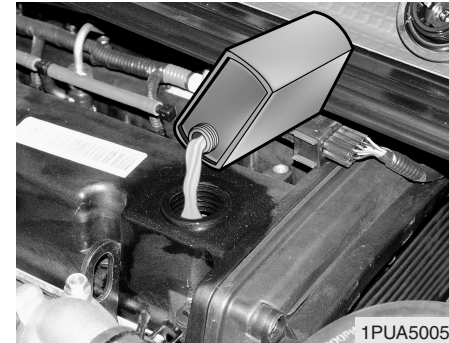

If it is near or at L, add enough oil to bring the level to F. **Do not overfill.**

Use only the specified engine oil. (Refer to "Recommended Lubricants" later in this section.)

Changing the engine oil and filter

We recommend that the engine oil and filter be replaced by an authorised Kia dealer.

WARNING

Used engine oil may cause irritation or cancer of the skin if left in contact with the skin for prolonged periods of time. Used engine oil contains chemicals that have caused cancer in laboratory animals. Always protect your skin by washing your hands thoroughly with soap and warm water as soon as possible after handling used oil.

1

2

3

4

5

6

7

8

9

ENGINE COOLING SYSTEM

The high-pressure cooling system has a reservoir filled with year-round antifreeze coolant. The reservoir is filled at the factory.

Check the antifreeze protection and coolant level at least once a year, at the beginning of the winter season, and before travelling to a colder climate.

CAUTION

- *When the engine overheats from low engine coolant, suddenly adding engine coolant may cause cracks in the engine. To prevent damage, add engine coolant slowly in small quantities.*
- *Do not drive with no engine coolant. It may cause water pump failure and engine seizure, etc.*

Checking the coolant level

WARNING



Removing radiator cap

- Never attempt to remove the radiator cap whilst the engine is operating or hot. Doing so might lead to cooling system and engine damage and could result in serious personal injury from escaping hot coolant or steam.
- Turn the engine off and wait until it cools down. Even then, use extreme care when removing the radiator cap. Wrap a thick towel around it, and turn it counterclockwise slowly to the first stop. Step back whilst the pressure is released from the cooling system. When you are sure all the pressure has been released, press down on the cap, using a thick towel, and continue turning counterclockwise to remove it.

(Continued)

(Continued)

- Even if the engine is not operating, do not remove the radiator cap or the drain plug whilst the engine and radiator are hot. Hot coolant and steam may still blow out under pressure, causing serious injury.

WARNING



The electric motor (cooling fan) is controlled by engine coolant temperature, refrigerant pressure and vehicle speed. It may sometimes operate even when the engine is not running. Use extreme caution when working near the blades of the cooling fan so that you are not injured by a rotating fan blades. As the engine coolant temperature decreases, the electric motor will automatically shut off. This is a normal condition.

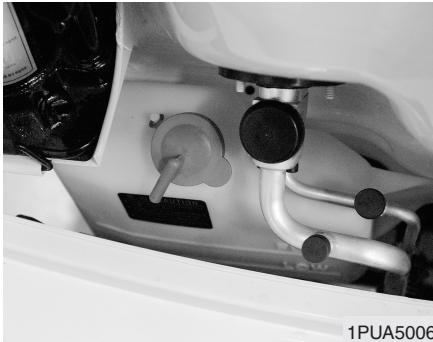

Check the condition and connections of all cooling system hoses and heater hoses. Replace any swollen or deteriorated hoses.

The coolant level should be filled between F and L marks on the side of the coolant reservoir when the engine is cool.

If the coolant level is low, add enough specified coolant to provide protection against freezing and corrosion. Bring the level to F, but do not overfill. If frequent additions are required, we recommend that the system be inspected by an authorised Kia dealer.

Adding coolant

- When adding coolant, use only deionized water or soft water for your vehicle and never mix hard water in the coolant filled at the factory. An improper coolant mixture can result in serious malfunction or engine damage.
- The engine in your vehicle has aluminum engine parts and must be protected by an ethylene-glycol-based coolant to prevent corrosion and freezing.
- DO NOT USE alcohol or methanol coolant or mix them with the specified coolant.
- Do not use a solution that contains more than 60% antifreeze or less than 35% antifreeze, which would reduce the effectiveness of the solution.

Have coolant changed in accordance with the maintenance schedule.

1

2

3

4

5

6

7

8

9

For mixture percentage, refer to the following table.

Ambient Temperature	Mixture Percentage (volume)	
	Coolant Solution	Water
-15°C (5°F)	35	65
-25°C (-13°F)	40	60
-35°C (-31°F)	50	50
-45°C (-49°F)	60	40

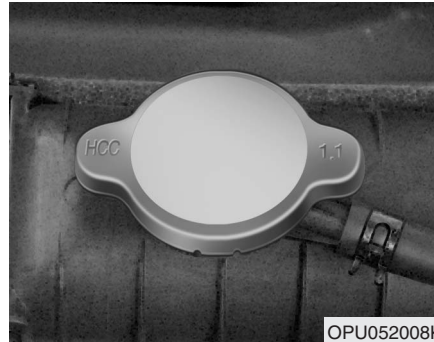

WARNING



Do not remove the radiator cap when the engine and radiator are hot. Scalding hot coolant and steam may blow out under pressure. This could cause serious injury.

1

2

3

4

5

6

7

8

9

BRAKES AND CLUTCH

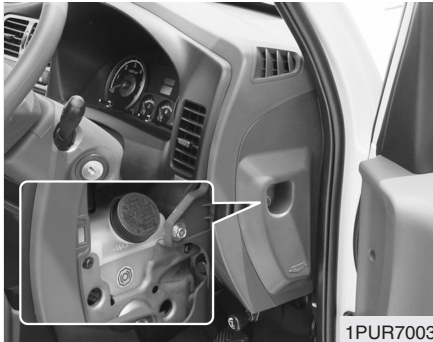

Checking brake/clutch fluid level

Check the fluid level in the reservoir periodically. The fluid level should be between MAX and MIN marks on the side of the reservoir.

Before removing the reservoir cap and adding brake/clutch fluid, clean the area around the reservoir cap thoroughly to prevent brake/clutch fluid contamination.

If the level is low, add fluid to the MAX level. The level will fall with accumulated mileage. This is a normal condition associated with the wear of the brake linings. If the fluid level is excessively low, we recommend that the system be checked by an authorised Kia dealer.

Use only the specified brake/clutch fluid. (Refer to “Recommended Lubricants” later in this section.)

Never mix different types of fluid.

⚠ WARNING

In the event the brake system requires frequent additions of fluid, we recommend that the system be inspected by an authorised Kia dealer.

⚠ WARNING

When changing and adding brake/clutch fluid, handle it carefully. Do not let it come in contact with your eyes. If brake/clutch fluid should come in contact with your eyes, immediately flush them with a large quantity of fresh tap water. Have your eyes examined by a doctor as soon as possible.

1

2

3

4

5

6

7

8

9

1

2

3

4

5

6

7

8

9

CAUTION

Do not allow brake/clutch fluid to contact the vehicle's body paint, as paint damage will result. Brake/clutch fluid, which has been exposed to open air for an extended time should never be used as its quality cannot be guaranteed. It should be thrown out. Don't put in the wrong kind of fluid. For example, just a few drops of mineral-based oil, such as engine oil, in your brake clutch system can damage brake clutch system parts.

PARKING BRAKE

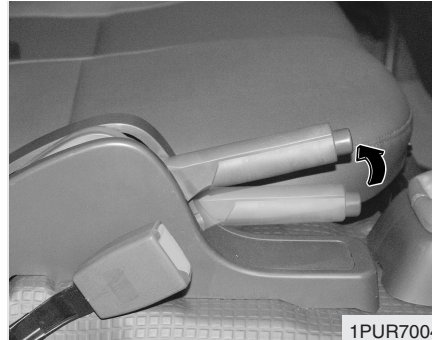

Checking the parking brake

Check the stroke of the parking brake by counting the number of “clicks” heard whilst fully applying it from the released position. Also, the parking brake alone should securely hold the vehicle on a fairly steep grade. If the stroke is more or less than specified, we recommend that the system be serviced by an authorised Kia dealer.

Stroke : 5~7 “clicks” at a force of 20 kg (44 lbs, 196 N).

POWER STEERING (IF EQUIPPED)

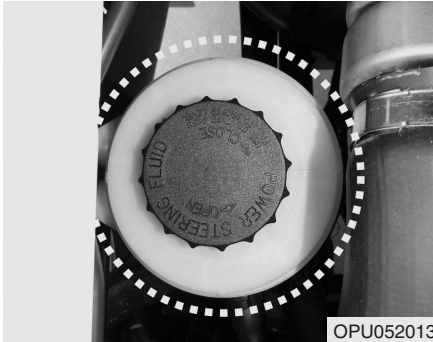

Checking the power steering fluid level

With the vehicle on level ground, check the fluid level in the power steering reservoir periodically. The fluid should be between MAX and MIN marks on the side of the reservoir at the normal temperature.

Before adding power steering fluid, thoroughly clean the area around the reservoir cap to prevent power steering fluid contamination.

If the level is low, add fluid to the MAX level.

In the event the power steering system requires frequent addition of fluid, we recommend that the system be inspected by an authorised Kia dealer.

* NOTICE

- To avoid damage to the power steering pump, do not operate the vehicle for prolonged periods with a low power steering fluid level.
- Never start the engine when the reservoir tank is empty.
- When adding fluid, be careful that dirt does not get into the tank.
- Too little fluid can make the steering wheel heavier or strange noise can be generated.
- The use of the non-specified fluid could reduce the effectiveness of the power steering wheel and cause damage to it.

Use only the specified power steering fluid. (Refer to "Recommended Lubricants" later in this section.)

Power steering hose

Check the connections for oil leaks, severe damage and the twists in the power steering hose before driving.

1

2

3

4

5

6

7

8

9

STEERING WHEEL

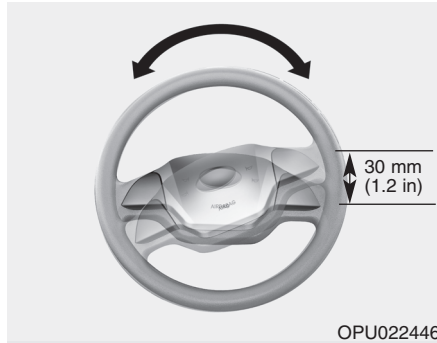

* NOTICE

If the measured value exceeds the standard value, we recommend that the system be checked by an authorised Kia dealer.

1

2

3

4

5

6

7

8

9

Park the vehicle on level ground, start the car and place the tyre wheels in the straight-ahead position. Turn the steering wheel to the left and right with a little force and check the free play until you get a feel for resistance against the tyre wheels movement.

Standard value: 30 mm (1.2 in) or less

LUBRICANTS AND FLUIDS

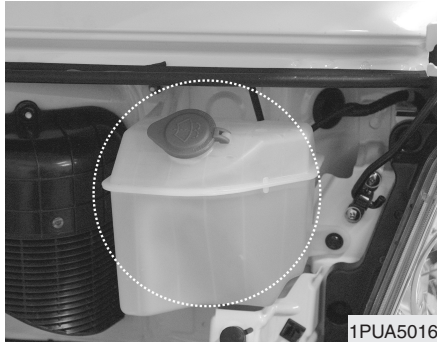

Checking the washer fluid level

The reservoir is translucent so that you can check the level with a quick visual inspection.

Check the fluid level in the washer fluid reservoir and add fluid if necessary. Plain water may be used if washer fluid is not available. However, use washer solvent with antifreeze characteristics in cold climates to prevent freezing.

⚠ WARNING

- **Do not use radiator coolant or antifreeze in the washer fluid reservoir.**
- **Radiator coolant can severely obscure visibility when sprayed on the windscreen and may cause loss of vehicle control or damage to paint and body trim.**
- **Windscreen Washer fluid agents contain some amounts of alcohol and can be flammable under certain circumstances. Do not allow sparks or flame to contact the washer fluid or the washer fluid reservoir. Damage to the vehicle or it's occupants could occur.**

Windscreen washer fluid is poisonous to humans and animals. Do not drink and avoid contacting windscreen washer fluid. Serious injury or death could occur.

Body lubrication

All moving points of the body, such as door hinges, bonnet hinges, and locks, should be lubricated each time the engine oil is changed. Use a non-freezing lubricant on locks during cold weather.

Make sure the engine bonnet secondary latch keeps the bonnet from opening when the primary latch is released.

1

2

3

4

5

6

7

8

9

FUEL FILTER

If water accumulates in the fuel filter, the warning light comes on when the ignition key is in the “ON” position.

CAUTION

If the water accumulated in the fuel filter is not drained at proper times, damages to the major parts such as the fuel system can be caused by water permeation in the fuel filter.

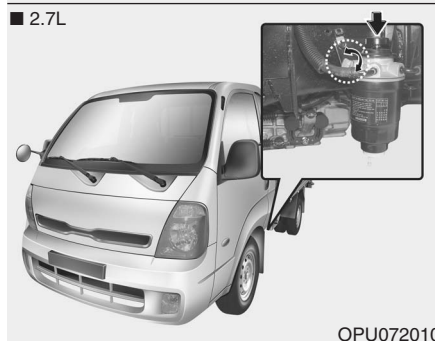
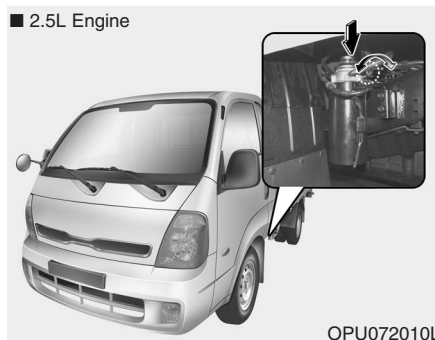

Extracting air in the fuel system

If you drove until you have no fuel left or if you replaced the fuel filter, be sure to extract air in the fuel system as it makes you difficult to start the engine.

- Remove the air extract plug on the top of the fuel filter.
- Pump up and down until the fuel flows out of the plug opening.
- Set the plug firmly into place if air has been extracted.

*** NOTICE**

- Use cloths when you extract air so that the fuel is not sprayed around.
- Clean the fuel around the fuel filter or the injection pump before starting the engine to prevent fire.
- Finally, check each part if the fuel is leaking.

1

2

3

4

5

6

7

8

9

■ 2.5L Engine



OPU072011L

■ 2.7L Engine



1PUB7011

Draining water from fuel filter

- Place a water tray under the fuel filter.

- Loosen the drain plug and drain water.
- After water is drained, securely tighten the drain plug.
- Pump the pump priming plunger and check to make sure that no fuel is leaking from the drain plug.
- After starting the engine, check to make certain the fuel filter warning light is off.

1
2
3
4
5
6
7
8
9

AIR CLEANER

1

2

3

4



Element cleaning

This element may be air cleaned or replaced, depending on its condition. Unless it is very dirty, merely shake it to remove foreign particles. Each time this filter is inspected, wipe the inside of the air cleaner housing and cover with a damp cloth. If the vehicle is operated in extremely dusty or sandy areas, clean or replace this element more often than at the usual recommended intervals.

5

6

7

8

9



Element replacement

A dry paper air cleaner filter is used. It must be replaced when necessary.

1. Loosen the air cleaner cover attaching clips and open the cover.
2. Wipe the inside of the air cleaner housing with a clean, damp cloth.
3. Replace the air cleaner element. We recommend that the air cleaner element be replaced with genuine Kia parts.
4. Lock the cover with the cover attaching clips.

Replace the element according to the Scheduled Maintenance Section. *If the vehicle is operated in extremely dusty or sandy areas, replace the element more often than the usual recommended intervals. (Refer to Maintenance Under Severe Usage Conditions in this section.)*

CAUTION

- **Do not drive with the air cleaner removed; this will result in excessive engine wear.**
- **Driving without an air cleaner encourages backfiring, which could cause a fire in the engine compartment.**
- **When removing the air cleaner element, be careful that dust or dirt does not enter the air intake, or damage may result.**

DUST FILTER



The dust filter installed in the entrance of the air duct filters the dust or other foreign substances that come into the vehicle from the outside through the heating and air conditioning system.

The dust filter should be cleaned every 20,000 km (12,000 miles). If the vehicle is operated on dusty rough roads for a long period, it should be inspected more frequently and cleaned earlier.

1

2

3

4

5

6

7

8

9

WIPER BLADES



Contamination of either the windscreen or the wiper blades with foreign matter can reduce the effectiveness of the windscreen wipers. Common sources of contamination are insects, tree sap, and hot wax treatments used by some commercial car washes. If the blades are not wiping properly, clean both the window and the blades with a good cleaner or mild detergent, and rinse thoroughly with clean water.

Windscreen wiper blade replacement

When the wipers no longer clean adequately, the blades may be worn or cracked, and require replacement.

* NOTICE

To prevent damage to the wiper arms or other components, do not attempt to move the wipers manually.

* NOTICE

The use of a non-specified wiper blade could result in wiper malfunction and failure.

Wiper blade maintenance

* NOTICE

Commercial hot waxes applied by automatic car washes have been known to make the windscreen difficult to clean.

* NOTICE

To prevent damage to the wiper blades, do not use petrol, kerosene, paint thinner, or other solvents on or near them.

1

2

3

4

5

6

7

8

9



1. Raise the wiper arm and turn the wiper blade assembly to expose the plastic locking clip.

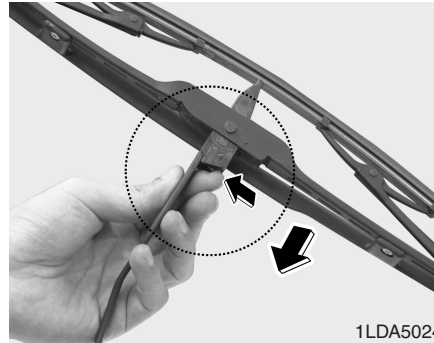

2. Compress the clip and slide the blade assembly downward.



3. Lift it off the arm.
4. Install the blade assembly in the reverse order of removal.

*** NOTICE**

Do not allow the wiper arm to fall against the windscreen.

- 1
- 2
- 3
- 4
- 5
- 6
- 7
- 8
- 9

BATTERY

* NOTICE

Basically equipped battery is maintenance free type. If your vehicle is equipped with the battery marked with LOWER and UPPER on the side, you can check the electrolyte level. The electrolyte level should be between LOWER and UPPER. If the electrolyte level is low, it needs to add distilled (demineralized) water (Never add sulfuric acid or other electrolyte). When refill, be careful not to splash the battery and adjacent components. And do not overfill the battery cells. It can cause corrosion on other parts. After then ensure that tighten the cell caps. We recommend that you contact an authorised Kia dealer.

WARNING - Battery dangers



Always read the following instructions carefully when handling a battery.



Keep lighted cigarettes and all other flames or sparks away from the battery.



Hydrogen, which is a highly combustible gas, is always present in battery cells and may explode if ignited.



Keep batteries out of the reach of children because batteries contain highly corrosive **SULFURIC ACID**. Do not allow battery acid to contact your skin, eyes, clothing or paint finish.

(Continued)

(Continued)



If any electrolyte gets into your eyes, flush your eyes with clean water for at least 15 minutes and get immediate medical attention. If possible, continue to apply water with a sponge or cloth until medical attention is received.

If electrolyte gets on your skin, thoroughly wash the contacted area. If you feel a pain or a burning sensation, get medical attention immediately.



Wear eye protection when charging or working near a battery. Always provide ventilation when working in an enclosed space.

(Continued)

1

2

3

4

5

6

7

8

9

(Continued)



An inappropriately disposed battery can be harmful to the environment and human health. Dispose the battery according to your local law(s) or regulation.

- When lifting a plastic-cased battery, excessive pressure on the case may cause battery acid to leak, resulting in personal injury. Lift with a battery carrier or with your hands on opposite corners.
- Never attempt to charge the battery when the battery cables are connected.
- The electrical ignition system works with high voltage. Never touch these components with the engine running or the ignition switched on.

Failure to follow the above warnings can result in serious bodily injury or death.

CAUTION

- *When you don't use the vehicle for a long time in the low temperature area, separate the battery and keep it indoors.*
- *Always charge the battery fully to prevent battery case damage in low temperature area.*
- *If you connect unauthorised electric devices to the battery, the battery may be discharged. Never use unauthorised devices.*

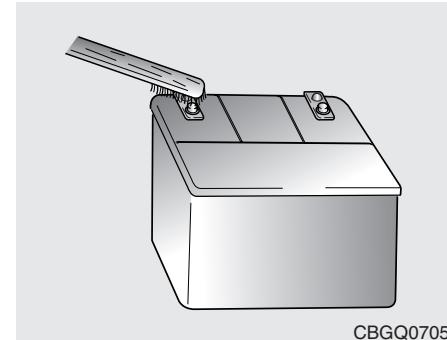

CBGQ0705

For best battery service :

- Keep the battery securely mounted.
- Keep the battery top clean and dry.
- Keep the terminals and connections clean, tight, and coated with petroleum jelly or terminal grease.
- Rinse any spilled electrolyte from the battery immediately with a solution of water and baking soda.
- If the vehicle is not going to be used for an extended time, disconnect the battery cables.

1

2

3

4

5

6

7

8

9

Example



OJD072039

* The actual battery label in the vehicle may differ from the illustration.

Battery capacity label (see the example)

1. CMF65L-BCI : The Kia model name of battery
2. 12V : The nominal voltage
3. 60Ah(20HR) : The nominal capacity (in Ampere hours)
4. 92RC : The nominal reserve capacity (in min.)
5. 550CCA : The cold-test current in amperes by SAE
6. 440A : The cold-test current in amperes by EN

Battery recharging

Your vehicle has a maintenance-free, calcium-based battery.

- If the battery becomes discharged in a short time (because, for example, the headlights or interior lights were left on whilst the vehicle was not in use), recharge it by slow charging (trickle) for 10 hours.
- If the battery gradually discharges because of high electric load whilst the vehicle is being used, recharge it at 20-30A for two hours.

Items to be reset after the battery has been discharged or the battery has been disconnected.

- Clock (See page 3-38)
- Climate control system (See pages 4-32)
- Audio (See the audio manual)

⚠ WARNING - Recharging battery

When recharging the battery, observe the following precautions:

- The battery must be removed from the vehicle and placed in an area with good ventilation.
- Do not allow cigarettes, sparks, or flame near the battery.
- Watch the battery during charging, and stop or reduce the charging rate if the battery cells begin gassing (boiling) violently or if the temperature of the electrolyte of any cell exceeds 49°C (120°F).

(Continued)

(Continued)

- Wear eye protection when checking the battery during charging.
- Disconnect the battery charger in the following order.
 1. Turn off the battery charger main switch.
 2. Unhook the negative clamp from the negative battery terminal.
 3. Unhook the positive clamp from the positive battery terminal.

*** NOTICE**

- Before performing maintenance or recharging the battery, turn off all accessories and stop the engine.
- The negative battery cable must be removed first and installed last when the battery is disconnected.

1

2

3

4

5

6

7

8

9

TYRES AND WHEELS

Tyres care

For proper maintenance, safety, and maximum fuel economy, you must always maintain recommended tyre inflation pressures and stay within the load limits and weight distribution recommended for your vehicle.

Inflation pressures

All tyre pressures (including the spare) should be checked every day when the tyres are cold. "Cold Tyres" means the vehicle has not been driven for at least three hours or driven less than 1.6 km (one mile).

Recommended pressures must be maintained for the best ride, top vehicle handling, and minimum tyre wear.

WARNING

Severe underinflation (70 kPa (10 psi) or more) can lead to severe heat build-up, especially on hot days and when driving at high speed. This can potentially cause tread separation and other tyre irregularities to appear that can result in the loss of vehicle control leading to severe injury or death.

* NOTICE

- Warm tyres normally exceed recommended cold tyre pressures by 28 to 41 kPa (4 to 6 psi). Do not release air from warm tyres to adjust the pressure or the tyres will be underinflated.
- Underinflation results in excessive wear, poor handling, reduced fuel economy, and the possibility of blowouts from overheated tyres. Also, low tyre pressure can cause poor sealing of the tyre bead. If the tyre pressure is excessively low, wheel deformation and/or tyre separation is possible. So, keep your tyre pressures at the proper levels. If a tyre frequently needs refilling, we recommend that the system be checked by an authorised Kia dealer.
- Overinflation produces a harsh ride, handling problems, excessive wear at the centre of the tyre tread, and a greater possibility of damage from road hazards.

(Continued)

1

2

3

4

5

6

7

8

9

(Continued)

- Be sure to reinstall the tyre inflation valve caps. Without the valve cap, dirt or moisture could get into the valve core and cause air leakage. If the cap have been lost, install new one as soon as possible.

⚠ WARNING - Tyre Inflation
Overinflation or underinflation can reduce tyre life, adversely affect vehicle handling, and lead to sudden tyre failure. This could result in loss of vehicle control.

Tyre rotation

To equalize tread wear, it is recommended that the tyres be rotated every 12,000 km (7,500 miles) or sooner if irregular wear develops.

During rotation, check the tyres for correct balance.

When rotating tyres, check for uneven wear and damage. Abnormal wear is usually caused by incorrect tyre pressure, improper wheel alignment, out-of-balance wheels, severe braking or severe cornering. Look for bumps or bulges in the tread or side of tyre. Replace the tyre if you find either of these conditions. Replace the tyre also if you can see fabric or cord. After rotation, be sure to bring the front and rear tyre pressures to specification and check lug nut tightness.

Refer to Section 8, Specifications.

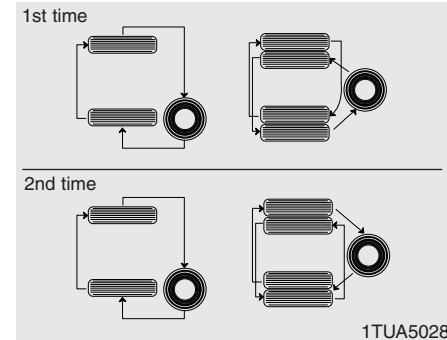

Disc brake pads and rear brake shoes should be inspected for wear whenever tyres are rotated.

* NOTICE

Rotate radial tyres that have an asymmetric tread pattern only from front to rear and not from right to left.

1

2

3

4

5

6

7

8

9

1

2

3

4



Tyre replacement

5

If the tyre is worn evenly, a tread wear indicator will appear as a solid band across the tread. This shows there is less than 1.6 mm (1/16 inch) of tread left on the tyre. Replace the tyre when this happens.

6

Do not wait for the band to appear across the entire tread before replacing the tyre.

7

CAUTION

When replacing the tires, recheck and tighten the wheel nuts after driving about 1,000 km(620miles). If the steering wheel shakes or the vehicle vibrates while driving, the tire is out of balance. Align the tire balance. If the problem is not solved, we recommend that you contact an authorized Kia dealer.

Wheel alignment and tyre balance

The wheels on your vehicle were aligned and balanced carefully at the factory to give you the longest tyre life and best overall performance.

In most cases, you will not need to have your wheels aligned again. However, if you notice unusual tyre wear or your vehicle pulling one way or the other, the alignment may need to be reset.

If you notice your vehicle vibrating when driving on a smooth road, your wheels may need to be rebalanced.

*** NOTICE**

Improper wheel weights can damage your vehicle's aluminum wheels. Use only approved wheel weights.

⚠ WARNING

- When replacing tyres, never mix radial, bias-belted, and bias-type tyres. All four tyres should be of the same size, design and construction. Use only the tyre sizes listed on the Tyre Label found below the door striker on the driver's side. Make sure that all tyres and wheels are the same size and have the same load-carrying capacity. Use only tyre and wheel combinations recommended on the Tyre Label or by an Authorised Kia Dealer. Failure to follow these precautions can adversely affect the safety and handling of your vehicle.
- The use of any other tyre size or type may seriously affect ride, handling, ground clearance, tyre clearance, and speedometer calibration.

(Continued)

(Continued)

- **Driving on worn-out tyres is very hazardous and will reduce braking effectiveness, steering accuracy, and traction.**
- It is best to replace all four tyres at the same time. If that is not possible, or necessary, then replace the two front or two rear tyres as a pair. Replacing just one tyre can seriously affect your vehicle's handling.
- The ABS works by comparing the speed of the wheels. Tyre size can affect wheel speed. When replacing tyres, all 4 tyres must use the same size originally supplied with the vehicle. Using tyres of a different size can cause the ABS (Anti-lock Brake System) and ESP (Electronic Stability Program) to work irregularly.

Wheel replacement

When replacing the metal wheels for any reason, make sure the new wheels are equivalent to the original factory units in diameter, rim width and offset.

⚠ WARNING

A wheel that is not the correct size may adversely affect wheel and bearing life, braking and stopping abilities, handling characteristics, ground clearance, body-to-tyre clearance, snow chain clearance, speedometer calibration, headlight aim and bumper height.

1

2

3

4

5

6

7

8

9

1

Tyre size designation

A tyre's sidewall is marked with a tyre size designation. You will need this information when selecting replacement tyres for your car. The following explains what the letters and numbers in the tyre size designation mean.

2

3

4

5

6

7

8

9

Example tyre size designation:

195 R14C 102/100R

(These numbers are provided as an example only; your tyre size designator could vary depending on your vehicle.)

195 - Tyre width in millimeters.

R - Tyre construction code (Radial).

14 - Rim diameter in inches.

C - Commercial tyre.

102/100 - Load Index, a numerical code associated with the maximum load the tyre can carry.

R - Speed Rating Symbol. See the speed rating chart in this section for additional information.

5.00 R12LT 83/81P

(These numbers are provided as an example only; your tyre size designator could vary depending on your vehicle.)

5.00 - Tyre width in inches.

R - Tyre construction code (Radial).

12 - Rim diameter in inches.

LT - Light truck tyre.

83/81 - Load Index, a numerical code associated with the maximum load the tyre can carry.

P - Speed Rating Symbol. See the speed rating chart in this section for additional information.

Wheel size designation

Wheels are also marked with important information that you need if you ever have to replace one. The following explains what the letters and numbers in the wheel size designation mean.

Example wheel size designation:

6.0 J x 14

6.0 - Rim width in inches.

J - Rim contour designation.

14 - Rim diameter in inches.

Tyre speed ratings

The chart below shows many of the different speed ratings currently being used for passenger car. The speed rating symbol is part of the tyre size designation on the sidewall of the tyre. This symbol corresponds to that tyre's designed maximum safe operating speed.

Speed Rating Symbol	Maximum Speed
P	150 km/h (93 mph)
Q	160 km/h (99 mph)
R	170 km/h (106 mph)
S	180 km/h (112 mph)
T	190 km/h (118 mph)
H	210 km/h (130 mph)
V	240 km/h (149 mph)
Z	Above 240 km/h (149 mph)

WARNING - Tyre temperature

Excessive speed, underinflation, or excessive loading, either separately or in combination, can cause heat build-up and possible sudden tyre failure. This can cause loss of vehicle control and serious injury or death.

1

2

3

4

5

6

7

8

9

1

2

3

4



Checking a tyre life

5

Tyre strength and performance decline with age. Any tyres that are over 6 year old, including the spare (determined by the tyre manufacture date), should be replaced regardless of mileage. You can find the tyre manufacture date on the tyre sidewall (either on the inside or outside of the wheel). The date is a Department Of Transportation (DOT) number consisting of letters and numbers. You can determine the tyre manufacture date by the last four numbers of the DOT code.

6

7

8

9

DOT : XXXX XXXX 0000

The first letters/numbers of the DOT indicate the manufacturing plant, tyre size and tread pattern, last four numbers indicate week and year manufactured.

For example:

DOT XXXX XXXX 0813 represents that the tyre was produced in the 8th week of 2013.

⚠ WARNING

Tyres degrade over time, even when they are not being used. Regardless of the remaining tread, it is recommended that tyres generally be replaced after six (6) years of normal service. Heat caused by hot climates or frequent high loading conditions can accelerate the aging process. Failure to follow this warning can result in sudden tyre failure, which could lead to a loss of control and an accident involving serious injury or death.

Low aspect ratio tyre (if equipped)

Low aspect ratio tyres, whose aspect ratio is lower than 50, are provided for sporty looks.

Because the low aspect ratio tyres are optimized for handling and braking, it may be more uncomfortable to ride in and there is more noise compare with normal tyres.

CAUTION

Because the sidewall of the low aspect ratio tyre is shorter than the normal, the wheel and tyre of the low aspect ratio tyre is easier to be damaged. So, follow the instructions below.

- *When driving on a rough road or off road, drive cautiously because tyres and wheels may be damaged. And after driving, inspect tyres and wheels.*
- *When passing over a pothole, speed bump, manhole, or curb stone, drive slowly so that the tyres and wheels are not damaged.*
- *If the tyre is impacted, we recommend that you inspect the tyre condition or contact an authorized Kia dealer.*
- *To prevent damage to the tyre, inspect the tyre condition and pressure every 3,000km.*

CAUTION

- *It is not easy to recognize the tyre damage with your own eyes. But if there is the slightest hint of tyre damage, even though you cannot see the tyre damage with your own eyes, have the tyre checked or replaced because the tyre damage may cause air leakage from the tyre.*
- *If the tyre is damaged by driving on a rough road, off road, pothole, manhole, or curb stone, it will not be covered by the warranty.*
- *You can find out the tyre information on the tyre sidewall.*

1

2

3

4

5

6

7

8

9

BULB REPLACEMENT

⚠ WARNING - Working on the lights

Prior to working on the light, firmly apply the parking brake, ensure that the ignition switch is turned to the "LOCK" position and turn off the lights to avoid sudden movement of the vehicle and burning your fingers or receiving an electric shock.

Use only the bulbs of the specified wattage.



- ① Headlight (High/Low)
- ② Position light
- ③ Front turn signal light
- ④ Front fog light (if equipped)

Headlight bulb replacement

* NOTICE

After heavy, driving rain or washing, headlight and taillight lenses could appear frosty. This condition is caused by the temperature difference between the lamp inside and outside.

(Continued)

(Continued)

This is similar to the condensation on your windows inside your vehicle during the rain and doesn't indicate a problem with your vehicle. If the water leaks into the lamp bulb circuitry, we recommend that the system be checked by an authorised Kia dealer.

1

2

3

4

5

6

7

8

9



1LDA7048

⚠ WARNING - Halogen bulbs

- Halogen bulbs contain pressurized gas that will produce flying pieces of glass if broken.
- Always handle them carefully, and avoid scratches and abrasions. If the bulbs are lit, avoid contact with liquids. Never touch the glass with bare hands. Residual oil may cause the bulb to overheat and burst when lit. A bulb should be operated only when installed in a headlight.

(Continued)

(Continued)

- If a bulb becomes damaged or cracked, replace it immediately and carefully dispose of it.
- Wear eye protection when changing a bulb. Allow the bulb to cool down before handling it.

*** NOTICE**

If the vehicle has had front body repair or the headlight assembly has been replaced, we recommend that the headlight aiming be checked by an authorised Kia dealer.



1PUB7012

1. Open the bonnet.
2. Loosen the retaining bolts and remove the light assembly from the body of the vehicle.

1
2
3
4
5
6
7
8
9

1

2

3

4

5

6

7

8

9

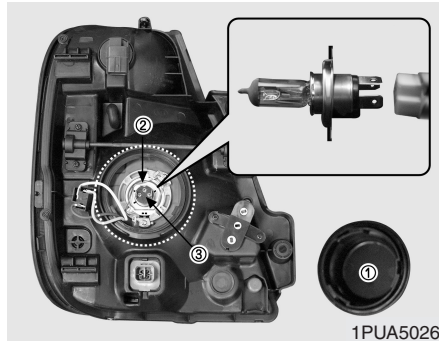

3. Disconnect the headlight main electrical connector. Disconnect the front turn signal light electrical connector.
4. Remove the headlight bulb cover by turning it counterclockwise.
5. Disconnect the headlight bulb socket-connector.
6. Unsnap the headlight bulb retaining wire by depressing the end and pushing it upward.

7. Remove the bulb from the headlight assembly.
8. Install a new headlight bulb and snap the headlight bulb retaining wire into position by aligning the wire with the groove on the bulb.
9. Connect the headlight bulb socket-connector.
10. Install the headlight bulb cover by turning it clockwise.
11. Connect the headlight main connector. Connect the front turn signal light electrical connector.
12. Reinstall the light assembly to the body of the vehicle.

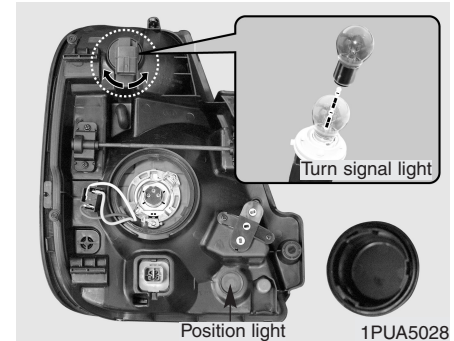

Position / turn signal light bulb replacement

1. Remove the headlight assembly. Refer to “Headlight bulb replacement” on the preceding pages.
2. Remove the socket from the assembly by turning the socket counterclockwise until the tabs on the socket align with the slots on the assembly.

3. Remove the bulb by pulling it straight out.
4. Install a new bulb in the socket.
5. Install the socket in the assembly by aligning the tabs on the socket with the slots in the assembly. Insert the socket into the assembly and turn the socket clockwise.
6. Connect the headlight main connector. Connect the front turn signal light electrical connector.
7. Reinstall the light assembly to the body of the vehicle.

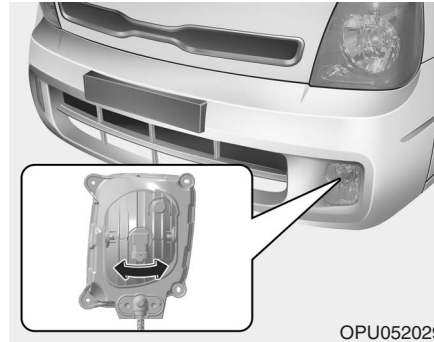

Front fog light bulb replacement (if equipped)

1. Reach your hand into the front bumper below the fog light housing.
2. Remove the socket from the housing by turning the socket counter clockwise until the tabs on the socket align with the slots on the housing.

3. Remove the bulb by pulling it straight out.
4. Install a new bulb in the socket.
5. Install the socket in the housing by aligning the tabs on the socket with the slots in the housing. Insert the socket into the housing and turn the socket clockwise.

1

2

3

4

5

6

7

8

9

1

2

3

4

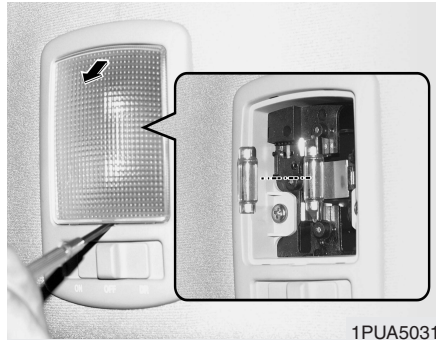

Interior light bulb replacement

1. Using a flat-blade screwdriver, gently pry the lens from the interior light housing.

CAUTION

Prior to working on the Interior Lights, ensure that the "OFF" button is depressed to avoid burning your fingers or receiving an electric shock.

2. Remove the bulb by pulling it straight out.
3. Install a new bulb in the socket.
4. Align the lens tabs with the interior light housing notches and snap the lens into place.

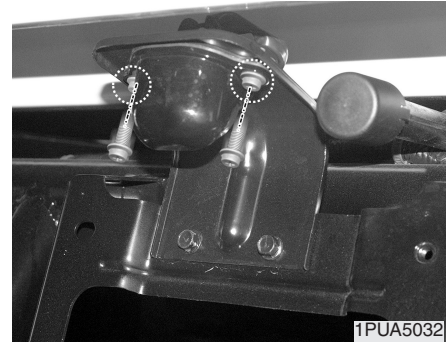

License plate light bulb replacement

1. Loosen the lens retaining screws with a cross-tip screwdriver.
2. Remove the bulb from the socket by pressing it in and rotating it until the tabs on the bulb align with the slots in the socket. Pull the bulb out of the socket.
3. Insert a new bulb by inserting it into the socket and rotating it until it locks into place.
4. Install a new bulb.
5. Reinstall the lens securely with the lens retaining screws.



- ① Rear turn signal light
- ② Stop and tail light
- ③ Back-up light

1PUA5034

Rear combination light bulb replacement

1. Press the lock tabs on the cover with your fingers and remove the cover.

2. Remove the socket from the assembly by turning the socket counterclockwise until the tabs on the socket align with the slots on the assembly.
3. Remove the bulb from the socket by pressing it in and rotating it until the tabs on the bulb align with the slots in the socket. Pull the bulb out of the socket.
4. Insert a new bulb by inserting it into the socket and rotating it until it locks into place.
5. Install the socket in the assembly by aligning the tabs on the socket with the slots in the assembly. Push the socket into the assembly and turn the socket clockwise.
6. Install the cover.

1

2

3

4

5

6

7

8

9

LUBRICANT SPECIFICATIONS

Recommended lubricants

To help achieve proper engine and powertrain performance and durability, use only lubricants of the proper quality. The correct lubricants also help promote engine efficiency that results in improved fuel economy.

Engine oils labeled Energy Conserving Oil are now available. Along with other additional benefits, they contribute to fuel economy by reducing the amount of fuel necessary to overcome engine friction. Often, these improvements are difficult to measure in everyday driving, but in a year's time, they can offer significant cost and energy savings.

Recommended SAE viscosity number

* NOTICE

Always be sure to clean the area around any filler plug, drain plug, or dipstick before checking or draining any lubricant. This is especially important in dusty or sandy areas and when the vehicle is used on unpaved roads. Cleaning the plug and dipstick areas will prevent dirt and grit from entering the engine and other mechanisms that could be damaged.

These lubricants and fluids are recommended for use in your vehicle.

Lubricant			Classification
Engine oil *1	2.5L Engine	with DPF	ACEA C3*2
		without DPF	ACEA B4*2
	2.7L Engine		API CF-4 or above ACEA B2,B3 or above SAE 10W-30
Manual transmission fluid			API Service GL-4 (SAE 75W-85, fill-for-life)
Differential fluid	2.7L Engine	With LSD	LSD OIL API Service GL-5 (SAE 85W-90)
		Without LSD	API Service GL-5 (SAE 90)
	2.5 Engine (A-II 2.5)	All (with LD, without LD, 4WD front)	
Transfer case fluid			API Service GL-4 (SAE 75W-85, fill-for-life)
Power steering fluid			PSF-III
Brake/clutch fluid			FMVSS116 DOT-3 or DOT-4

*1 Refer to the recommended SAE viscosity numbers on the next page.

*2 ACEA certificated engine oil must be used as service engine oil.

Only in case that ACEA engine oil is not available, engine oil above API CH-4 is allowed restrictively.

1

2

3

4

5

6

7

8

9

Engine oil viscosity (thickness) has an effect on fuel economy and cold weather operating (starting and oil flow). Lower viscosity engine oils can provide better fuel economy and cold weather performance, however, higher viscosity engine oils are required for satisfactory lubrication in hot weather. Using oils of any viscosity other than those recommended could result in engine damage.

When choosing an oil, consider the range of temperature your vehicle will be operated in before the next oil change. Proceed to select the recommended oil viscosity from the chart.

		Temperature Range for SAE Viscosity Numbers									
Temperature	°C	-30	-20	-10	0	10	20	30	40	50	
	(°F)	-10	0	20	40	60	80	100	120		
Engine oil	2.5L/ 2.7L	15W-40									
		10W-30, 10W-40									
		5W-30, 5W-40									
		0W-30 ^{*1} , 0W-40									

*1 : It is only for extreme cold area and to be restricted by driving condition and area. (Especially, not recommended for sustained high loaded and high speed operation.)

- 1
- 2
- 3
- 4
- 5
- 6
- 7
- 8
- 9

EXTERIOR CARE

Exterior general caution

It is very important to follow the label directions when using any chemical cleaner or polish. Read all warning and caution statements that appear on the label.

Even prompt washing with plain water may not completely remove all these deposits. A mild soap, safe for use on painted surfaces, may be used.

After washing, rinse the vehicle thoroughly with lukewarm or cold water. Do not allow soap to dry on the finish.

Finish maintenance

Washing

To help protect your vehicle's finish from rust and deterioration, wash it thoroughly and frequently at least once a month with lukewarm or cold water.

If you use your vehicle for off-road driving, you should wash it after each off-road trip. Pay special attention to the removal of any accumulation of salt, dirt, mud, and other foreign materials. Make sure the drain holes in the lower edges of the doors and rocker panels are kept clear and clean.

Insects, tar, tree sap, bird droppings, industrial pollution and similar deposits can damage your vehicle's finish if not removed immediately.

CAUTION

- *Do not use strong soap, chemical detergents or hot water, and do not wash the vehicle in direct sunlight or when the body of the vehicle is warm.*
- *Do not wash the side windows too close with high pressure water. Water may leak through the windows and wet the interior.*
- *To prevent damage to the plastic parts and lamps, do not clean with chemical solvents or strong detergents.*

WARNING

After washing the vehicle, test the brakes whilst driving slowly to see if they have been affected by water. If braking performance is impaired, dry the brakes by applying them lightly whilst maintaining a slow forward speed.

1

2

3

4

5

6

7

8

9

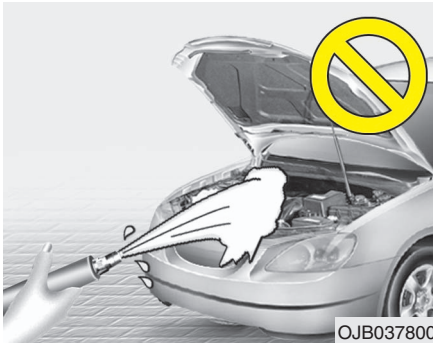

CAUTION

- *Water washing in the engine compartment including high pressure water washing may cause the failure of electrical circuits located in the engine compartment.*
- *Pay extreme attention to wash the engine compartment by using water.*

Waxing

Wax the vehicle when water will no longer bead on the paint.

Always wash and dry the vehicle before waxing. Use a good quality liquid or paste wax, and follow the manufacturer's instructions. Wax all metal trim to protect it and to maintain its luster.

Removing oil, tar, and similar materials with a spot remover will usually strip the wax from the finish. Be sure to re-wax these areas even if the rest of the vehicle does not yet need waxing.

*** NOTICE**

- Wiping dust or dirt off the body with a dry cloth will scratch the finish.
- Do not use steel wool, abrasive cleaners, or strong detergents containing highly alkaline or caustic agents on chrome-plated or anodized aluminum parts. This may result in damage to the protective coating and cause discoloration or paint deterioration.

1

2

3

4

5

6

7

8

9

1

2

3

4

5

6

7

8

9

Finish damage repair

Deep scratches or stone chips in the painted surface must be repaired promptly. Exposed metal will quickly rust and may develop into a major repair expense.

* NOTICE

If your vehicle is damaged and requires any metal repair or replacement, be sure the body shop applies anti-corrosion materials to the parts repaired or replaced.

Bright-metal maintenance

- To remove road tar and insects, use a tar remover, not a scraper or other sharp object.
- To protect the surfaces of bright-metal parts from corrosion, apply a coating of wax or chrome preservative and rub to a high luster.
- During winter weather or in coastal areas, cover the bright metal parts with a heavier coating of wax or preservative. If necessary, coat the parts with non-corrosive petroleum jelly or other protective compound.

Underbody maintenance

Corrosive materials used for ice and snow removal and dust control may collect on the underbody. If these materials are not removed, accelerated rusting can occur on underbody parts such as the fuel lines, frame, floor pan and exhaust system, even though they have been treated with rust protection.

Thoroughly flush the vehicle underbody and wheel openings with lukewarm or cold water once a month, after off-road driving and at the end of each winter. Pay special attention to these areas because it is difficult to see all the mud and dirt. It will do more harm than good to wet down the road grime without removing it. The lower edges of doors, rocker panels, and frame members have drain holes that should not be allowed to clog with dirt; trapped water in these areas can cause rusting.

⚠ WARNING

After washing the vehicle, test the brakes whilst driving slowly to see if they have been affected by water. If braking performance is impaired, dry the brakes by applying them lightly whilst maintaining a slow forward speed.

Aluminum or chrome wheel maintenance

The aluminum or chrome wheels are coated with a clear protective finish.

- Do not use any abrasive cleaner, polishing compound, solvent, or wire brushes on aluminum or chrome wheels. They may scratch or damage the finish.
- Clean the wheel when it has cooled.
- Use only a mild soap or neutral detergent, and rinse thoroughly with water. Also, be sure to clean the wheels after driving on salted roads. This helps prevent corrosion.
- Avoid washing the wheels with high-speed car wash brushes.
- Do not use any alkaline or acid detergent. It may damage and corrode the aluminum or chrome wheels coated with a clear protective finish.

1

2

3

4

5

6

7

8

9

INTERIOR CARE

Interior general precautions

Prevent chemicals such as perfume, cosmetic oil, sun cream, hand cleaner, and air freshener from contacting the interior parts because they may cause damage or discoloration. If they do contact the interior parts, wipe them off immediately. See the instructions that follow for the proper way to clean vinyl.

CAUTION

When cleaning leather products (steering wheel, seats etc.), use neutral detergents or low alcohol content solutions. If you use high alcohol content solutions or acid/alkaline detergents, the colour of the leather may fade or the surface may get stripped off.

Cleaning the upholstery and interior trim

Vinyl

Remove dust and loose dirt from vinyl with a whisk broom or vacuum cleaner. Clean vinyl surfaces with a vinyl cleaner.

Fabric

Remove dust and loose dirt from fabric with a whisk broom or vacuum cleaner. Clean with a mild soap solution recommended for upholstery or carpets. Remove fresh spots immediately with a fabric spot cleaner. If fresh spots do not receive immediate attention, the fabric can be stained and its colour can be affected. Also, its fire-resistant properties can be reduced if the material is not properly maintained.

CAUTION

Using anything but recommended cleaners and procedures may affect the fabric's appearance and fire-resistant properties.

Cleaning the lap/shoulder belt webbing

Clean the belt webbing with any mild soap solution recommended for cleaning upholstery or carpet. Follow the instructions provided with the soap. Do not bleach or re-dye the webbing because this may weaken it.

Cleaning the interior window glass

If the interior glass surfaces of the vehicle become fogged (that is, covered with an oily, greasy or waxy film), they should be cleaned with glass cleaner. Follow the directions on the glass cleaner container.

*** NOTICE**

Do not scrape or scratch the inside of the rear window. This may result in damage to the rear window defroster grid.

	Specifications / 8-2	1
		2
		3
		4
		5
		6
		7
	Specifications	8
		9

SPECIFICATIONS

The specifications given here are for general information only. For more precise and more up-to-date information, we recommend that you check an authorised Kia dealer.

Dimensions

mm

Item		Long Body	Extra Long Body	Long Body (High deck)
		Standard cab	Standard cab	Standard cab
Overall length		4,825	5,125	4,825
Overall width		1,740	1,740	1,740
Overall height	2.5L	1,995	1,995	1,995
	2.7L	1,975	1,970	-
Front tread		1,490	1,490	1,490
Rear tread		1,340	1,340	1,460
Wheel base		2,415	2,615	2,415
Cargo deck	Length	2,810	3,110	2,810
	Width	1,630	1,630	1,630
	Height	355	355	355

Tyres

Item			Front		Rear	
			Tyre	Inflation Pressure kPa (psi)	Tyre	Inflation Pressure kPa (psi)
2.5L	Lowdeck	Standard cab. King cab.	195R15-8PR	310 (45)	5.00R12-8PR	450 (65)
		Double cab.	195R15-8PR	310 (45)	145R13C-8PR	430 (62)
	Highdeck		195R15-8PR	350 (51)	195R15-8PR	390 (57)
2.7L	Lowdeck	Standard cab. King cab.	195R14-6PR	310 (45)	5.00R12-8PR	390 (57)
		Double cab.	195R14-6PR	310 (45)	145R13C-8PR	390 (57)
	High Deck		195R14-8PR	310 (45)	195R14-8PR	390 (57)
Wheel lug nut torque kg·m (lb·ft, N·m)			¹⁾ 9.0 ~12.0 (65~87, 88~118) ²⁾ 19.0 ~22.0 (137~159, 186~216)		19.0~22.0 (137~159, 186~216)	

- 1
- 2
- 3
- 4
- 5
- 6
- 7
- 8
- 9

Capacities

Lubricant		Volume	Classification	
1 2 3 	2.5L	with DPF	7.4 l (7.8 US qt.)	ACEA C3
		without DPF		ACEA B4
	2.7L	2WD	6.4 l (6.8 US qt.)	API CF-4 or above ACEA B2,B3 or above SAE 10W-30
		4WD	6.8 l (7.2 US qt.)	
4 Engine oil consumption	Normal driving condition		MAX. 1 l /1500 km	-
	Severe driving condition		MAX. 1 l /1000 km	-
5 Manual transmission fluid	2.5L	2.2 ~ 2.3 l (2.3 ~ 2.4 US qt.)	API Service GL-4 SAE 75W-85 (fill for-life)	
	2.7L	2.2 ~ 2.3 l (2.3 ~ 2.4 US qt.)		
6 Transfer case fluid (if equipped)		1.1 l (1.2 US qt.)	API Service GL-4 SAE 75W-85 (fill for-life)	
7 8 Differential fluid	2.7L	With LSD	1.3 l (1.4 US qt.)	LSD OIL API Service GL-5 (SAE 85W-90)
		Without LSD	1.3 l (1.4 US qt.)	
	2.5L	ALL (With LD, Without LD)	1.6 l (1.7 US qt.)	STD OIL API Service GL-5 (SAE 90)

*1 : Refer to the recommended SAE viscosity numbers on the page 7-49.

*2 : Engine oils labeled Energy Conserving Oil are now available. Along with other additional benefits, they contribute to fuel economy by reducing the amount of fuel necessary to overcome engine friction. Often, these improvements are difficult to measure in everyday driving, but in a year's time, they can offer significant cost and energy savings.

Lubricant		Volume	Classification
Power steering fluid		1.1 l ~1.2 l (1.2 ~ 1.3 US qt.)	PSF-III
Coolant	2.5L	12.6 l (13.3 US qt.)	Ethylene glycol base for aluminum radiator
	2.7L	11.2 l (11.8 US qt.)	
Brake/clutch fluid		0.35 l (0.37 US qt.)	FMVSS116 DOT-3 or DOT-4
Fuel	2.7L	60 l (15.9 US gal)	-
	2.5L	65 l (17.2 US gal)	

- 1
- 2
- 3
- 4
- 5
- 6
- 7
- 8
- 9

Light bulbs

Light Bulb	Wattage
Headlights (Low/High)	55/60
Front turn signal lights	21
Position lights	5
Side repeater lights (if equipped)	5
Front fog lights (if equipped)	27
Stop and tail lights	21/5
Rear turn signal lights	21
Back-up lights	21
Rear fog lights (if equipped)	21
License plate lights	10
Front room lamp	10
Dome lamp (if equipped)	10

DECLARATION OF CONFORMITY

■ Example

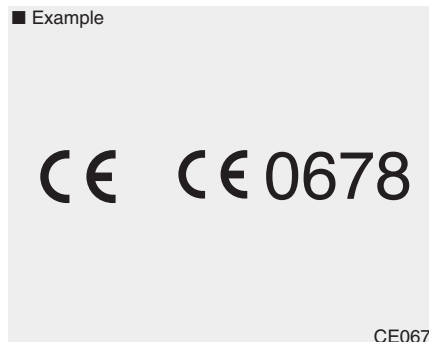

CE0678

The radio frequency components of the vehicle comply with requirements and other relevant provisions of Directive 1995/5/EC.

Further information including the manufacturer's declaration of conformity is available on Kia web site as follows;

<http://www.kia-hotline.com>

			1
			2
			3
			4
			5
			6
			7
			8
	Index		9

Index

A

- Air bag - supplemental restraint system3-31
- Air cleaner.....7-32
- Antenna3-51
- Ashtray3-48
- Audio system3-51
 - Antenna3-51

B

- Battery7-36
- Battery saver function4-32
- Before driving5-4
- Bonnet3-41
- Brake system4-10
 - Anti-lock brake system (ABS).....4-14
 - Parking brake4-12, 7-25
 - Power brakes4-10
- Brakes and clutch.....7-25
- Bulb replacement7-48
 - Front fog light bulb replacement.....7-51
 - Interior light bulb replacement.....7-52
 - License plate light bulb replacement7-52
 - Position/turn signal light bulb replacement7-50
 - Rear combination light bulb replacement.....7-53

C

- Capacities8-4
- Centre seatback console tray3-48
- Central door lock switch3-9
- Changing tyres6-20
- Chains
 - Tyre chains5-9
- Checking a tyre life.....7-46
- Climate control system4-39
 - Air conditioning4-44
- Cigarette lighter3-48
- Cup holder3-49

D

- Defogging logic4-49
- Digital clock3-52
- Dimensions8-2
- Driver-side knee bolster.....6-8
- Door locks.....3-8
 - Central door lock switch3-9
- Driving at night5-8
- Driving in flooded areas5-11
- Driving in the rain5-8
- Dust filter7-33

E

- Electrical circuit protection.....6-7
 - Driver-side knee bolster6-8
 - Fuses6-7
 - Fuse panel description6-9
- Emergency starting6-5
 - Jump starting procedure6-5
 - Push-starting6-6
- Emergency whilst driving6-3
- Emission control system5-2
- Engine compartment7-18
- Engine cooling system7-22
- Engine number5-13
- Engine oil and oil filter7-20
- Engine temperature gauge4-22
- Exterior care7-56
- Exterior overview2-2

F

- Flat tyre6-18
 - Changing tyres6-20
 - Jack and tools6-18
 - Reinstalling the spare tyre.....6-19
 - Removing the spare tyre6-18

- Front fog light bulb replacement7-51
- Front seat adjustment3-13
- Front passenger’s seat3-16
- Fuel filler3-44
- Fuel filter7-30
- Fuel gauge4-22
- Fuses6-7
 - Fuse panel description6-9
 - Main fuse6-9
 - Memory fuse6-10

G

- Gauge
 - Engine temperature gauge.....4-22
 - Fuel gauge4-22
 - Odometer4-20
 - Speedometer4-20
 - Tachometer4-21
 - Tripmeter4-20
- Glove box3-47

H

- Hazard warning flasher4-38
- Hazardous driving conditions5-7
- Headlight levelling device4-35



Index

Headrest adjustment3-15
Horn4-17
How to use this manual1-2

1

I

Ignition switch4-2
Identification label5-12
Immobiliser system3-3
Instrument cluster4-18
 With tachometer4-19
 Without tachometer4-18
Interior care7-60
Interior features3-48
 Ashtray3-48
 AUX, USB and iPod3-50
 Cigarette lighter3-48
 Cup holder3-49
 Digital clock3-50
 Sunvisor3-49
Interior light3-46
Interior light bulb replacement7-52
Interior overview2-3

9

J

Jack and tools6-18
Jump starting6-5

K

Keys3-2

L

Label information5-12
 Engine number5-13
 Identification label5-12
 Load sensing5-13
 Vehicle identification number (VIN)5-12
License plate light bulb replacement7-52
Light bulbs8-6
Lighting4-32
 Battery saver function4-32
 Headlight levelling device4-35
Limited slip differential4-8
Locking differential4-9
Lubricant specifications7-54
Lubricants and fluids7-29

M

Main fuse6-9
Maintenance schedule7-5
Maintenance under severe usage conditions7-11
Maintenance services7-3

Manual transmission4-6
 Memory fuse6-13
 Mirrors3-45
 Day/night rearview mirror3-46
 Manual remote control3-45
 Outside rearview mirror3-45

O

Odometer4-20
 Oil (level)7-20
 Outside rearview mirror3-45
 Overheating6-4
 Overloading5-11
 Owner maintenance7-15

P

Parking brake4-10, 7-26
 Position/turn signal light bulb replacement7-50
 Power brakes4-10
 Power steering4-16, 7-27
 Power window3-11
 Push starting6-6

R

Rear combination light bulb replacement7-53
 Rear gate3-42
 Rear parking assist system4-29
 Remote keyless entry3-5
 Road warning6-2
 Rocking the vehicle5-7

S

Safety belts3-18
 Lap belt3-24
 Lap/shoulder belt3-22
 Safety belt warning light3-22
 Seats3-13
 Centre seat3-16
 Driver's seat3-13
 Front seat adjustment3-13
 Front passenger's seat3-16
 Headrest adjustment3-15
 Side gate3-43
 Snow tyres5-9
 Special driving conditions5-7
 Driving at night5-8
 Driving in flooded areas5-11
 Driving in the rain5-8

1

2

3

4

5

6

7

8

9

Index

	Hazardous driving conditions	5-7
	Rocking the vehicle	5-7
	Snow tyres	5-9
	Tyre chains	5-9
	Winter driving	5-9
1	Specifications	8-2
2	Capacities	8-4
3	Dimensions	8-2
3	Light bulbs	8-7
3	Tyres	8-3
4	Speedometer	4-20
4	Starting the engine	4-4
4	Steering wheel	4-16
5	Horn	4-17
5	Power steering	4-16, 7-27
5	Tilt steering	4-16
6	Storage compartment	3-47
6	Centre seatback console tray	3-48
7	Glove box	3-47
7	Suggestions for economical operation	5-6
8	Sunvisor	3-49
9	T	
	Tachometer	4-21
	Tilt steering	4-16
	Tyre	8-3
	Tyre chains	5-9

	Tyres and wheels	7-40
	Checking a tyre life	7-46
	Low aspect ratio tyre	7-47
	Tyre care	7-40
	Tyre replacement	7-42
	Tyre rotation	7-41
	Tyre size designation	7-44
	Tyre speed ratings	7-45
	Wheel alignment and tyre balance	7-42
	Wheel size designation	7-45
	Wheel replacement	7-43
	Towing	6-14

V

	Vehicle break-in process	1-3
	Vehicle identification number (VIN)	5-12

W

	Warnings and indicators	4-23
	Wheel alignment and tyre balance	7-42
	Wheel size designation	7-45
	Wheel replacement	7-43
	Windows	3-11
	Manual window	3-11
	Power window	3-11

Windscreen defrosting and defogging4-48
 Defogging logic4-49
Winter driving5-9
 Snow tyres5-9
 Tyre chains5-9
Wiper blades7-34
Wipers and washers4-36

