



# OPERATOR'S HANDBOOK

Mack® TerraPro™ Series  
(LEU Series)

Mack® LEU Series

21394654

© Mack Trucks, Inc. 2010  
Printed in U.S.A.

OPERATOR'S HANDBOOK

21394654



# OPERATOR'S HANDBOOK

Mack® TerraPro™ Series  
(LEU Series)

21394654  
April 2010





# Foreword

This manual contains information concerning the operation and function of the Mack Link System. The information in this manual applies to vehicles built April 2010 and later. Please keep this manual in the vehicle at all times.

**Note:** Illustrations in this manual are used for reference only and may differ slightly from the actual vehicle. However, key components addressed in this document are represented as accurately as possible.

The National Highway Traffic Safety Administration (NHTSA) and Mack Trucks Inc., should be informed immediately if you believe that the vehicle has a defect that could cause a crash, injury or death.

Contact NHTSA by calling the Auto Safety Hotline at 1 (888) 327-4236, by writing to NHTSA, U.S. Department of Transportation, Washington, DC 20590, by TTY at 1 (800) 424-9153, or visit their website at [www.nhtsa.dot.gov](http://www.nhtsa.dot.gov).

**Mack Truck, Inc.**  
Greensboro, NC USA

**Order number: PV776-21394654**

©2010 Mack Trucks, Inc., Greensboro, NC USA

All rights reserved. No part of this publication may be reproduced, stored in retrieval system, or transmitted in any forms by any means, electronic, mechanical, photocopying, recording or otherwise, without the prior written permission of Mack Trucks, Inc.

---

# Contents

<b>INTRODUCTION.....</b>	<b>1</b>
TO THE OWNER.....	1
In Appreciation .....	1
About This Handbook.....	2
THE VEHICLE.....	3
Basic Configuration .....	3
Vehicle Management and Control System (V-MAC®).....	3
<b>COMPONENT IDENTIFICATION.....</b>	<b>4</b>
VIN Locations.....	4
Engine Identification.....	5
Engine Information Plate .....	6
Clean Idle Engines .....	7
Transmission Identification.....	8
<b>WARRANTY INFORMATION.....</b>	<b>10</b>
Air Brake System.....	10
<b>ENGINE GASEOUS EMISSION CONTROL SYSTEMS.....</b>	<b>10</b>
Emissions Control System Warranty .....	11
<b>ENGINE GASEOUS EMISSIONS CONTROL SYSTEM WARRANTY.....</b>	<b>13</b>
<b>FEDERAL EMISSION REQUIREMENTS.....</b>	<b>14</b>
<b>EMISSION CONTROL SYSTEMS WARRANTY — CALIFORNIA.....</b>	<b>14</b>
Emissions Control System Warranty .....	16
<b>SERVICE LITERATURE.....</b>	<b>20</b>
MACK Class 8 –Components Service Manual .....	20
MACK Class 8 – Custom Collated Service Manual on CD.....	20
<b>CUSTOMER SERVICE.....</b>	<b>21</b>
Call 1-800-866-1177 for MACK OneCall™.....	21
Questions and Complaints .....	21
Addresses.....	22
Additional Assistance .....	22
<b>REPORTING SAFETY DEFECTS.....</b>	<b>24</b>
United States.....	24
Canada.....	24
Mexico.....	24
<b>EVENT DATA RECORDING DEVICES.....</b>	<b>25</b>
<b>SAFETY INFORMATION.....</b>	<b>26</b>
SAFETY STATEMENT .....	26
<b>CERTIFICATION LABELS.....</b>	<b>28</b>
Safety Certification Label .....	28
<b>ADVISORY LABELS.....</b>	<b>30</b>
Advisory Label Locations (On Vehicle).....	30
<b>CAB ENTRY/EXIT.....</b>	<b>39</b>
Three-Limb Contact.....	39
Driver Side.....	41
Passenger Side.....	43
<b>SAFETY TIPS FOR COLD WEATHER OPERATION.....</b>	<b>44</b>
Driver Visibility.....	44



Cab Door Seals and Key Locks .....	45
Outside Mirror Heater .....	45
Air Horn Snow Shield.....	46
Fire Extinguisher (Optional).....	46
<b>INSTRUMENTS AND CONTROLS .....</b>	<b>47</b>
CAB INTERIOR — LEFT .....	47
CAB INTERIOR — RIGHT .....	48
INSTRUMENT PANEL .....	49
Tell-Tales.....	49
Panel Arrangement.....	50
INSTRUMENT PANEL GAUGE LAYOUT .....	51
Panels A, B, C and D .....	52
Panel E .....	53
Panel F .....	54
DPF INHIBIT ROAD SPEED LIMITING (RSL).....	62
CAB CLIMATE CONTROL .....	68
LIGHT CONTROL PANEL .....	69
STEERING COLUMN .....	70
Combination Starter and Electrical Switch.....	70
MISCELLANEOUS CONTROLS .....	71
Dome Light .....	71
Air Horn .....	71
Fresh Air Vent.....	72
Accessory Power Outlets .....	72
<b>PRE-TRIP INSPECTION AND DAILY MAINTENANCE .....</b>	<b>73</b>
PRE-TRIP .....	73
Pre-Trip Inspection Quick List .....	73
<b>OPERATION.....</b>	<b>86</b>
.....	86
New Vehicle Break-In.....	86
WINDSHIELD WASHER RESERVOIR .....	88
CAB TILT OPERATION.....	89
Tilting the Cab .....	90
Lowering the Cab.....	92
Bleeding the Cab Tilt System .....	93
DOORS .....	94
Opening the Cab Door .....	94
Locking the Cab Door.....	94
Right-Side (Folding) Door .....	94
Folding the Door .....	97
Unfolding the Door.....	100
SEAT BELTS .....	102
Seat Belt Operation .....	102
Fastening Seat Belt .....	102
RIGHT-SIDE RESTRAINT .....	105

---

SEAT ADJUSTMENT.....	106
Right-Side Folding Seat.....	106
Air Seat.....	107
MIRROR SYSTEMS.....	109
Moto Mirror System.....	109
MACK ENGINE INFORMATION.....	112
Precautions and Warnings.....	112
Engine Model Designations.....	113
CRUISE CONTROL OPERATION.....	114
Speed Control Switches.....	114
Disengaging Cruise Control.....	115
MACK POWERLEASH™ ENGINE BRAKE (IF EQUIPPED).....	116
Engine Brake Switch.....	117
How the Engine Brake is Activated.....	117
Cruise Control with the MACK PowerLeash™ Engine Brake.....	118
ON THE ROAD WITH THE MACK POWERLEASH™ ENGINE BRAKE.....	119
Over Flat Terrain.....	119
Descending a Grade.....	120
On Slippery Road Surfaces.....	122
BRAKE OPERATION.....	124
Air Brake System.....	124
Automatic Slack Adjusters.....	125
Parking Brake System.....	125
Parking Brake Operation.....	126
Parking.....	126
Anti-Lock Brake System (ABS).....	127
Automatic Traction Control (ATC) (If Equipped).....	130
Work Brake System.....	131
GOOD DRIVING HABITS.....	133
Weight Ratings.....	133
Instruments.....	133
Shutting Down the Engine.....	133
General Observation.....	133
STARTING THE VEHICLE.....	134
General Information.....	134
Push Button Starters.....	134
Air Starters.....	135
Engine Warm-Up.....	138
Engine Idling.....	138
Shutting Down the Engine.....	139
COLD WEATHER OPERATION.....	141
Cold Weather Starting Tips.....	141
Engine Block Heaters.....	142
MOVING THE VEHICLE — GENERAL INFORMATION.....	143
Braking.....	143
Engine Temperature.....	143
TRANSMISSION SHIFTING INSTRUCTIONS.....	145

Status Lights .....	148
Transmission Module Location .....	149
AXLES.....	150
Rear Axles Other Than MACK .....	150
MACK Rear Axles.....	150
Engaging the Power Divider Lockout.....	151
Extended Idling and Aftertreatment System Conditioning .....	154
<b>Mack, US10 Emissions Solution .....</b>	<b>155</b>
DIESEL PARTICULATE FILTERS .....	155
Exhaust Aftertreatment System .....	158
Safety Information .....	159
Exhaust Aftertreatment System Components and .....	160
Selective Catalytic Reduction (SCR) .....	160
Diesel Exhaust Fluid (DEF).....	162
Aftertreatment Diesel Particulate Filter (DPF).....	165
Aftertreatment Control Module (ACM).....	166
Exhaust Aftertreatment System .....	166
Driver Warnings and On Board Diagnostics (OBD) .....	172
On Board Diagnostics (OBD).....	172
Instrument Cluster.....	173
Malfunction Indicator Lamp (MIL).....	174
Aftertreatment DEF Tank Level - Driver Warning & Inducement.....	175
Aftertreatment DEF Quality - Driver Warning & Inducement.....	176
Misfilling Diesel or Aftertreatment DEF Tanks.....	177
SCR Tampering - Driver Warning & Inducement .....	178
Warranty and Maintenance .....	179
Exhaust Aftertreatment System Maintenance.....	179
Engine Maintenance Intervals.....	179
<b>MAINTENANCE AND LUBRICATION.....</b>	<b>180</b>
MAINTENANCE INTRODUCTION .....	180
TURBOCHARGER.....	181
CLEANING YOUR VEHICLE.....	182
Exterior Washing .....	182
Cab and Hood .....	184
Chassis .....	184
Cab Interior .....	184
Waxing .....	185
Polishing .....	185
Winter Warnings .....	185
TOWING .....	186
ENGINE OIL LEVEL CHECK.....	188
Power Steering Reservoir .....	189
FUEL TANK.....	190
Fuel Tank Cap.....	190
FUELING .....	191

---

BioDiesel.....	192
B5 Approval For MACK US 2010 Certified Products.....	192
COOLING SYSTEM.....	194
Coolant Level Check.....	194
Draining the Cooling System.....	195
Refilling the Cooling System.....	195
Protecting the Cooling System.....	196
Cooling System Maintenance.....	197
Accessory Drive Belt Routing.....	198
HEADLIGHTS.....	199
Bulb Replacement.....	199
WHEELS.....	199
Wheel Inspection.....	199
Tires.....	200
BATTERY.....	203
Jump-Starting Engine.....	203
ELECTRICAL.....	205
Circuit Breaker and Relay Panels.....	205
Electrical Grease.....	209
Circuit Protection Charts.....	210
<b>METRIC CONVERSIONS.....</b>	<b>212</b>
METRIC CONVERSIONS.....	212



---

# Safety Information

**IMPORTANT:** Before driving this vehicle, be certain that you have read and that you fully understand each and every step of the driving and handling information in this manual. Be certain that you fully understand and follow all safety warnings.

IT IS IMPORTANT THAT THE FOLLOWING INFORMATION BE READ, UNDERSTOOD AND ALWAYS FOLLOWED.

The following types of advisories are used throughout this manual:

## **DANGER**

Danger indicates an unsafe practice that could result in serious personal injury or death. A danger advisory banner is in **white** type on a **black** background with a **black** border.

## **WARNING**

Warning indicates an unsafe practice that could result in personal injury. A warning advisory banner is in **black** type on a **gray** background with a **black** border.

## **CAUTION**

Caution indicates an unsafe practice that could result in damage to the product. A caution advisory is in **black** type on a **white** background with a **black** border.

**Note:** Note indicates a procedure, practice, or condition that must be followed in order for the vehicle or component to function in the manner intended.

---

---

## TO THE OWNER

### In Appreciation

Thank you for buying a Mack® vehicle. With proper care and maintenance, your new Mack® TerraPro™ LEU model will help you gain a competitive edge with its fuel-efficient drivetrain combinations, low maintenance, extended service intervals and, eventually, good resale value.

The Mack® TerraPro™ LEU model is available for a wide range of applications. Because of this versatility, drivetrains and components vary and operating instructions may differ from one model to another. While every effort has been made to cover all current arrangements, do not hesitate to consult your MACK distributor if a question arises. Honest, personal service is standard with every MACK sale.



#### CAUTION

Mack Trucks, Inc. would like to point out the important role that the driver plays in the life of the vehicle. Only trained and informed drivers should operate this vehicle.

We, at Mack Trucks, Inc., hope that you will be happy with your new Mack® TerraPro™ LEU model, and that you see many years of trouble-free driving.

This vehicle was built to conform to all federal standards and regulations applicable at the time of manufacture.



## 2 INTRODUCTION

---

### About This Handbook

This handbook is referred to as the *Mack® TerraPro™ LEU Series Operator's Handbook*. It covers all Mack® TerraPro™ LEU models. Its identification number is 21394654. Keep this handbook with the vehicle at all times to ensure that each owner and/or operator will have access to all pertinent information relating to the operation and handling of this vehicle.

This handbook was prepared to provide the driver with all relevant information concerning the daily operation of this vehicle. Please read it thoroughly; pay particular attention to advisory labels that have been included to draw attention to important issues of operator safety and overall performance.

Information and illustrations in this handbook are based on the latest production usage at the time of printing and are subject to change without prior notice.

**Note:** Basic maintenance and lubrication procedures are found in this manual beginning with “MAINTENANCE INTRODUCTION”, page 180. For further information, refer to the Maintenance and Lubrication Manual (21394653). Other important information can be found in the Emission Control Systems for MACK Diesel Engine Manual (21351488).

---

## THE VEHICLE

### Basic Configuration

The Mack® TerraPro™ LEU model has a low-entry, cab-forward-style operators compartment. One-step entry and dual steering/braking arrangements make it a very popular and practical vehicle for refuse management companies.

### Vehicle Management and Control System (V-MAC®)

The Vehicle Management and Control System (V-MAC) is an electronic control system that manages engine and vehicle functions. In addition, the DataMax™ portion of V-MAC monitors and stores a variety of information (i.e., maintenance schedules, overspeed logs, fault tables, trip summaries).

For a complete description of the V-MAC IV system, refer to the applicable *V-MAC® Operator's Guide*, which is supplied with the vehicle.

Additional information concerning service, diagnostics, programming and vendor equipment interface application is available from the Mack Trucks, Inc. Service Publications Department. Contact your local MACK dealer for details.



#### **WARNING**

Never cut into the V-MAC system wire harness to power additional equipment. If such equipment is to be installed, contact your MACK dealer for assistance.

# 4 INTRODUCTION

## COMPONENT IDENTIFICATION

Locate the following serial numbers and write them in the boxes provided next to each illustration.

### VIN Locations

The Vehicle Identification Number (VIN) is displayed in two locations (a frame rail stamping and a label). The 17-digit VIN must be identical in both locations.

The VIN frame stamping is located on the right outside frame rail and the left inside frame rail.

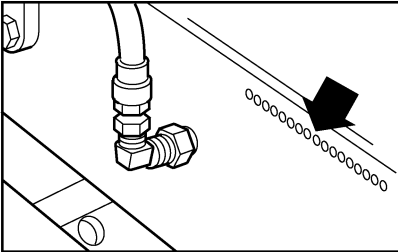

Right Outside Frame Rail Flange

**VEHICLE  
IDENTIFICATION  
NUMBER**

C0029554

The **VIN label** is located on the inside door frame below the driver seat.

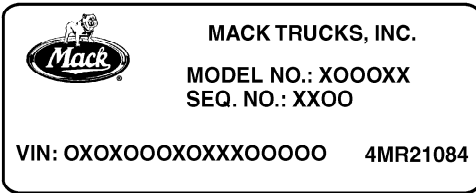

**Vehicle  
Identification  
Number**

C0028941

## Engine Identification

On the **MACK MP** engines, the engine serial number is stamped on the left side of the engine block, below the inlet manifold.

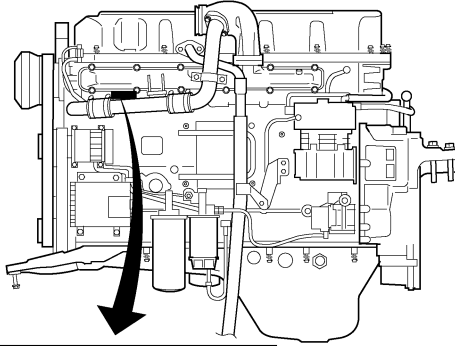

**ENGINE  
SERIAL  
NUMBER**

--

XX*123456*	A1*Y ○

# 6 INTRODUCTION

## Engine Information Plate

In compliance with Federal and California emission requirements, an engine information label is affixed to all MACK diesel engines. This label, which is located on the cylinder head cover at the front of the engine, gives basic engine identification information (engine model, serial number, etc.), advertised horsepower at rated speed, emissions regulations to which the engine conforms and inlet and exhaust valve lash settings. Examples of the 49 state EPA approved, and 50 state EPA and California approved engine identification labels are given below.

		<b>IMPORTANT ENGINE INFORMATION</b> RENSEIGNEMENTS IMPORTANTS MOTEUR		MACK TRUCKS, INC.		VALVE LASH (JEU SOUPAPES)	
		ENGINE FAMILY: AVPTH12.8S01 FAMILLE DE MOTEURS:		ENGINE MODEL: MP8-505C MODELE MOTEUR:		SERIAL NO.: 123456 NO. SERIE:	
DISPLACEMENT CYLINDREE	ADVERTISED HP @ RPM PUISS. SPEC. @ TOURS / MIN.	FUEL RATE @ ADVERTISED HP DEBIT DE CARB. @ PUISS. SPEC.	IDLE SPEED RALENTI	ENGINE BRAKE FREIN MOTEUR	INLET ROCKER .2 mm ADMISSION CULBUTEUR EXHAUST ROCKER .8 mm ECHAPPEMENT CULBUTEUR		
12.8 L	505/1500	342 mm <sup>3</sup> /STROKE mm <sup>3</sup> /COUP	550-700 RPM	- - - -	NOx FEL NOx FNE (g/Bhp-hr) NMHC+NOx FEL NMHC+NOx FNE (g/Bhp-hr)		
THIS ENGINE CONFORMS TO U.S. EPA REGULATIONS APPLICABLE TO 2010 MODEL YEAR NEW HEAVY-DUTY ENGINES AND HAS A PRIMARY INTENDED SERVICE APPLICATION AS A HEAVY HEAVY-DUTY DIESEL ENGINE.					PARTICULATE FEL 0.00 PARTICULAIRE FNE (g/Bhp-hr)		
Ce moteur est conforme aux réglementations de l'Agence de Protection de l'Environnement des États-Unis applicables aux nouveaux moteurs diesel Heavy duty (Gamme lourde) modèle 2010. La principale application s'adresse aux usages de type gamme lourde (Heavy-heavy-duty).					EXHAUST EMISSION CONTROL SYSTEM DISPOSITIF ANTI-POLLUTION		
E.M., EC, TC, CAC, D.I., EGR, DPF, SCR					THIS ENGINE IS CERTIFIED TO OPERATE ON ULTRA LOW SULFUR DIESEL FUEL ONLY.		
					DELEGATED ASSEMBLY		LABEL NO 21338494

W2040455

### Engine Identification Label - 49 State EPA Approved Engine without California "Clean Idle"

		<b>IMPORTANT ENGINE INFORMATION</b> RENSEIGNEMENTS IMPORTANTS MOTEUR		MACK TRUCKS, INC.		VALVE LASH (JEU SOUPAPES)	
		ENGINE FAMILY: AVPTH12.8S01 FAMILLE DE MOTEURS:		ENGINE MODEL: MP8-505C MODELE MOTEUR:		SERIAL NO.: 123456 NO. SERIE:	
DISPLACEMENT CYLINDREE	ADVERTISED HP @ RPM PUISS. SPEC. @ TOURS / MIN.	FUEL RATE @ ADVERTISED HP DEBIT DE CARB. @ PUISS. SPEC.	IDLE SPEED RALENTI	ENGINE BRAKE FREIN MOTEUR	INLET ROCKER .2 mm ADMISSION CULBUTEUR EXHAUST ROCKER .8 mm ECHAPPEMENT CULBUTEUR		
12.8 L	505/1500	342 mm <sup>3</sup> /STROKE mm <sup>3</sup> /COUP	550-700 RPM	- - - -	NOx FEL NOx FNE (g/Bhp-hr) NMHC+NOx FEL NMHC+NOx FNE (g/Bhp-hr)		
THIS ENGINE CONFORMS TO U.S. EPA AND CALIFORNIA REGULATIONS APPLICABLE TO 2010 MODEL YEAR NEW HEAVY-DUTY ENGINES AND HAS A PRIMARY INTENDED SERVICE APPLICATION AS A HEAVY HEAVY-DUTY DIESEL ENGINE.					PARTICULATE FEL 0.00 PARTICULAIRE FNE (g/Bhp-hr)		
Ce moteur est conforme aux réglementations de Californie et de l'Agence de Protection de l'Environnement des États-Unis applicables aux nouveaux moteurs diesel Heavy duty (Gamme lourde) modèle 2010. La principale application s'adresse aux usages de type gamme lourde (Heavy-heavy-duty).					EXHAUST EMISSION CONTROL SYSTEM DISPOSITIF ANTI-POLLUTION		
E.M., EC, TC, CAC, D.I., EGR, DPF, SCR					THIS ENGINE IS CERTIFIED TO OPERATE ON ULTRA LOW SULFUR DIESEL FUEL ONLY.		
					DELEGATED ASSEMBLY		LABEL NO 21338549

W2040456

### Engine Identification Label - 50 State EPA Approved Engine with California "Clean Idle"

## Clean Idle Engines

The California Air Resources Board (ARB) requires that 2008 and later model year vehicles be equipped with engines having tamper-resistant software which limits the time at which the engine can idle at speeds above low idle (550–700 rpm). At speeds above low idle, and without a PTO engaged, idle time will be limited to five minutes, after which the engine will revert back to low idle. Vehicles equipped with a Clean Idle engine are identified by a label which is affixed to the lower portion of the driver's side door on cab-over models (LEU).



W2056289

**Clean Idle Engine Label**

# 8 INTRODUCTION

## Transmission Identification

The **Allison RDS and HS transmission** identification plate is located on the rear right side of the main case, near the lower end.

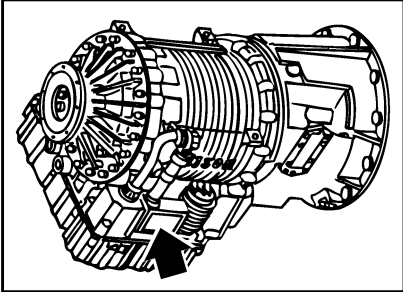

**Allison RDS  
Transmission  
Serial Number**

C0029555

The **MACK carrier assembly** serial number is located on the front right side of the housing.

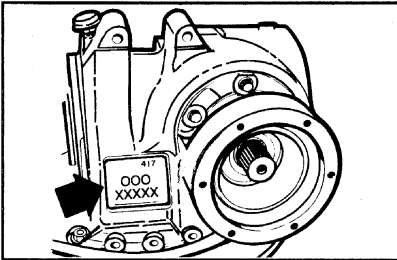

**Carrier Assembly  
Serial Number**

C0028950

The **Eaton® Spicer® rear axle** serial number is located on the rear of the axle housing toward the carrier.

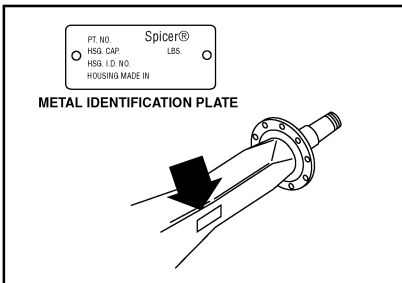

**Rear Axle  
Serial Number**

C0028951

The **Eaton® Spicer® carrier assembly** serial number is located on the left side of the forward carrier, and the top of the rear carrier.

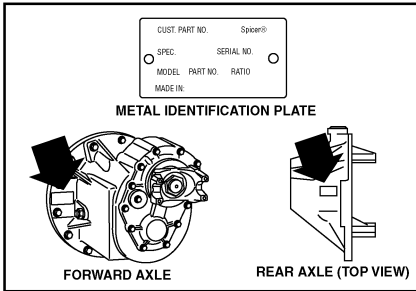

**Carrier  
Serial Number**

C0028952

The **MERITOR rear axle** identification tag is located on the left or right rear of the rear axle housing, next to the carrier.

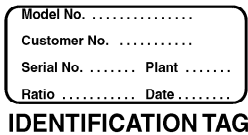

**Rear Axle  
Serial Number**



C0028953

The **MERITOR carrier assembly** serial number is located on the left side of the forward carrier, and the top of the rear carrier.

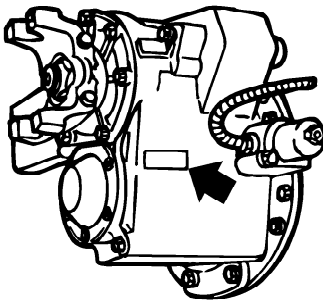

**Carrier  
Serial Number**

C0028954



# 10 INTRODUCTION

---

## WARRANTY INFORMATION

This chassis is equipped with a US'10 emission compliant engine and an exhaust aftertreatment system (Diesel Particulate Filter). Use of Ultra Low Sulfur Diesel (ULSD) fuel and EO-O Premium Plus (or VDS-4) specification high performance diesel engine oil is required in this vehicle.

**Note:** Use of improper or unapproved fuel or engine oil will void the engine and aftertreatment system warranty.

## Air Brake System

The MACK Standard Vehicle Warranty applies to the air brake system, as set forth in the Warranty, but only if the air brake system has not been subjected to unauthorized additions, deletions or modifications. If any such unauthorized additions, deletions or modifications are performed, Mack Trucks, Inc. disclaims any and all liability for any loss or damage arising out of a malfunction of the air brake system.

The air brake system was designed and built to conform to all applicable federal motor vehicle safety standards in effect at the time of manufacture.

Tractor air systems are designed for operation as a tractor only, and truck air systems are designed to be operated as a truck only. If a tractor is going to be converted for operation as a truck, the air brake system must be reconfigured to that of a truck. Conversely, if a truck is going to be converted for operation as a tractor, the air brake system must be reconfigured to that of a tractor. Consult your local MACK distributor for additional information.

If any unauthorized additions, deletions or modifications are made to any portion of the air brake system which is required by Federal Motor Vehicle Safety Standards, Mack Trucks, Inc. makes no representation as to conformity with the Standards.

For complete warranty information, refer to the *Pedigreed Protection Plan* provided with each vehicle.

## ENGINE GASEOUS EMISSION CONTROL SYSTEMS

### WARRANTY MAINTENANCE

**Note:** For emission control systems information on engines other than MACK, refer to the engine vendor's publication

**ENGINE GASEOUS EMISSION CONTROL SYSTEMS WARRANTY**

Mack Trucks, Inc. warrants the Emission Control Systems on each new Mack diesel engine in a new Mack Truck to comply with all United States Federal and Canadian emissions regulations applicable at the time of manufacture of the engine, and to be free from defects in material and workmanship under normal use and service up to 60 months, or 160934 km (100,000 miles), whichever ever occurs first, provided that all Mack Trucks, Inc. maintenance requirements are followed as described in this manual. All warranty periods are calculated from the date-in-service of the new vehicle.

The repair or replacement of defective parts will be made without charge for the cost of parts and if repairs are made at an authorized Mack Trucks, Inc. dealership, there will be no charge for labor. Mack Trucks, Inc.'s obligation under this warranty is limited to the repair or replacement, at Mack Trucks, Inc.'s option, of any part(s) of the Emission Control Systems of such engine and/or vehicle found to be defective upon examination by Mack Trucks, Inc. and provided that such part(s) were returned to Mack Trucks, Inc. or its nearest authorized Dealer within a reasonable period of time.

**Qualifications and Limitations:**

**Note: Not covered** by the Emissions Control Systems Warranty:

- Malfunctions caused by misuse, improper adjustments, modification, alteration, tampering, disconnection, improper or inadequate maintenance and use of improper diesel fuel or DEF.
- Damage resulting from accident, acts of nature or other events beyond the control of Mack Trucks, Inc.
- Inconvenience, loss of use of the vehicle, commercial loss of any kind including, but not limited to, consequential or incidental damages
- Any vehicle in which the odometer has been altered or damaged so that mileage cannot be readily determined.

**THIS WARRANTY IS EXPRESSLY IN LIEU OF ALL OTHER WARRANTIES AND REPRESENTATIONS OR CONDITIONS, STATUTORY OR OTHERWISE, EXPRESSED OR IMPLIED INCLUDING, BUT NOT LIMITED TO, IMPLIED WARRANTY OF MERCHANTABILITY OR FITNESS FOR A PARTICULAR PURPOSE.**

**Emissions Control System Warranty**

The following engine components are covered by the supplemental emissions control system warranty policy as required by the Federal code of emission regulations.

- 1 Turbocharger Assembly
  - VGT Actuator
  - CAC Hoses
- 2 Charge Air Cooler
- 3 Engine Control Module (ECM)
- 4 Injectors
- CAC Pipes (Air inlet to/from CAC)

## 12 INTRODUCTION

---

- 5 Engine and Vehicle Wire harness ( repair to circuits related to Emissions Warrantable Components )
- 6 Exhaust Gas Recirculation (EGR) Mixer
- 7 EGR Cooler
- 8 EGR Valve and EGR Valve Control
- 9 EGR Pipes - Engine Exhaust Manifold to EGR Cooler
- 10 EGR Pipes - EGR Cooler to Inlet Manifold
- 11 Crankcase Breather
- 12 Crankcase Separator
- 13 Crankcase Tubing and Hoses before Separator
- 14 Aftertreatment Wiring Harness
- 15 After treatment Control Module (ACM)
- 16 Aftertreatment Diesel Particulate Filter (DPF) Assembly
  - A. Aftertreatment DPF Assembly with Aftertreatment Diesel Oxidation Catalyst (DOC)
    - Aftertreatment Doser
    - Diffuser Pipe (Aftertreatment Fuel Doser Mounting)
    - Fuel lines to Aftertreatment Fuel Doser
    - Aftertreatment Fuel Shutoff Valve
    - Aftertreatment Fuel Pressure Sensor
    - Discharge Recirculation Valve (DRV) (Heat Mode)
    - Discharge Recirculation Valve (DRV) Solenoid
    - Engine Turbocharger Compressor Bypass Actuator (Heat Mode)
    - Engine Turbocharger Compressor Bypass Actuator Solenoid
    - Engine Exhaust Gas Temperature (EGT) Sensor
    - Aftertreatment DPF Intake Temperature Sensor
    - Aftertreatment DPF Outlet Temperature Sensor
    - Aftertreatment DPF Differential Pressure Sensor
    - Aftertreatment Doser Air Supply Regulator (if applicable), Supply Lines, and Fittings
  - B. Thermal Regeneration Unit (TRU)
    - Aftertreatment DPF Combustion Air Control Valve
    - Aftertreatment DPF Combustion Air Valve
    - Aftertreatment DPF Atomization Module
    - Aftertreatment DPF Ignition Coil
    - Aftertreatment DPF Fuel Control Valve
    - Aftertreatment DPF Ignition Electrode
    - Nozzle
    - Engine Exhaust Gas Temperature (EGT) Sensor
    - Aftertreatment DPF Intake Temperature Sensor
    - Aftertreatment DPF Outlet Temperature Sensor
    - Aftertreatment DPF Spark Assist Flame Temperature Sensor
    - Aftertreatment DPF Differential Pressure Sensor
- 17 Sensors:
  - Crankshaft Position (CKP)
  - Camshaft Position (CMP)
  - Engine Coolant Temperature (ECT)
  - Intake Manifold Air Temperature
  - Intake Manifold Pressure (IMP)
  - EGR Temperature

- Aftertreatment Outlet NOx
- Aftertreatment Intake NOx
- EGR Differential Pressure
- Ambient Air Temperature (AAT)
- Aftertreatment DEF Tank Heater
- Aftertreatment DEF Tank Heater Valve
- Aftertreatment DEF Tank Temperature Sensor

18 SCR

- Aftertreatment Selective Catalytic Reduction (SCR) Catalyst
- Aftertreatment DEF Level Sensor
- Aftertreatment DEF Heated Lines

- Aftertreatment Diesel Exhaust Fluid (DEF) Pump

- Aftertreatment DEF Dosing Absolute Pressure Sensor
- Aftertreatment DEF Return Valve

- Aftertreatment DEF Dosing Valve
- Aftertreatment DEF Tank
- Aftertreatment DEF Tank Heater/Sender

19. Instrument Cluster (Repair of microprocessor , OBD MIL, Real Time Clock, Aftertreatment DEF Tank Gauge and, Aftertreatment DEF Tank Low Level Indicator)

20. Exhaust Gas Piping (from Turbocharger to Aftertreatment System )

21. Data Link Connector (DLC)

## ENGINE GASEOUS EMISSIONS CONTROL SYSTEM WARRANTY

The emission warranty for the diesel particulate filter (DPF) and SCR System covers defects in workmanship only. Normal maintenance, such as cleaning ash from the filter at regular maintenance intervals and cleaning the aftertreatment fuel injector on Diesel oxidation catalyst (DOC) DPF systems, is not covered by the emission warranty. With the Thermal regenerator DPF system, cleaning the ignition electrodes and fuel injection nozzle at the regular maintenance intervals

is considered normal maintenance and not covered by the emission warranty.

**Note:** In response to customer requests, Mack Trucks, Inc. may build vehicles with engines supplied by other manufacturers. In these cases, each engine manufacturer through its service organization, is responsible for emission control systems warranty on all parts of the engine assembly, as furnished.

# 14 INTRODUCTION

---

## FEDERAL EMISSION REQUIREMENTS

This section covers the requirement of the United States Clean Air Act which states: "The manufacturer shall furnish with each new motor vehicle or motor vehicle engine such written instructions for the maintenance and use of the vehicle or engine by the ultimate purchaser as may

be reasonable and necessary to assure the proper functioning of emission control devices and systems." This section also covers the requirements of the emissions regulations promulgated under the Motor Vehicle Safety Act in Canada.

### TAMPERING WITH GASEOUS EMISSION CONTROL SYSTEMS PROHIBITED

The Federal Clean Air Act prohibits the removal or rendering inoperative of any device or element of design installed on or in a motor vehicle or motor vehicle engine in compliance with Federal Emission Regulations by:

- 1 Any person prior to its sale and delivery to the ultimate purchaser, or
- 2 Any manufacturer or distributor after its sale and delivery to the ultimate purchaser, or
- 3 Any person engaged in the business of repairing, servicing, selling, leasing, or

trading motor vehicles or motor vehicle engines following its sale and delivery to the ultimate purchaser, or

- 4 Any person who operates a fleet of motor vehicles following its sale and delivery to the ultimate purchaser.

**Note:** For specifics of the prohibited vehicle/engine modifications refer to the Mack Trucks, Inc. Body Builders documentation .

## EMISSION CONTROL SYSTEMS WARRANTY — CALIFORNIA

The California Air Resources Board and Mack Trucks, Inc. are pleased to explain the California emission control system warranty on your new motor vehicle engine. In California, new motor vehicle engines must be designed, built and equipped to meet the State's stringent anti-smog standards. Mack Trucks, Inc. must warrant the emission control system on your engine for the period of time listed below provided there has been no abuse, neglect, or improper maintenance of your engine.

Your emission control system may include parts such as the fuel-injection

system, turbocharger assembly, electronic control module and other emission-related assemblies.

Where a warrantable condition exists, Mack Trucks, Inc. will repair your engine at no cost to you including diagnosis, parts, and labor.

### MANUFACTURER'S WARRANTY COVERAGE:

If an emission-related part of your engine is defective, the part will be repaired or replaced by Mack Trucks, Inc. This is your emission control system DEFECTS WARRANTY.

---

## OWNER'S WARRANTY RESPONSIBILITIES:

As the motor vehicle engine owner, you are responsible for the performance of the required maintenance listed in this manual. Mack Trucks, Inc. recommends that you retain all receipts covering maintenance of your vehicle, but Mack Trucks, Inc. cannot deny warranty solely for the lack of receipts or for your failure to ensure the performance of all scheduled maintenance listed in other manuals which were supplied with your vehicle.

You are responsible for presenting your motor vehicle engine to a MACK dealer as soon as a problem exists. The warranty repairs should be completed in a reasonable amount of time, not to exceed 30 days. As the motor vehicle engine owner, you should also be aware that Mack Trucks, Inc. may deny you warranty coverage if your vehicle or a part has failed due to abuse, neglect, improper maintenance, or unapproved modifications.

If you have any questions regarding your warranty rights and responsibilities, you should contact the Mack Trucks, Inc. Warranty Activities P.O.Box 26259, Greensboro, NC 27402, or the California Air Resources Board at 9480 Telstar Avenue, El Monte, California 91731. **(Applicable only to vehicles and/or engines certified for sale and registered**

**in the State of California)** Mack Trucks, Inc. warrants the Emission Control Systems on each new MACK diesel engine in a new MACK truck to comply with all State of California emissions regulations applicable at the time of manufacture of the engine, and to be free from defects in material and workmanship under normal use and service up to 60 months, or 100,000 miles, or 3,000 engine operating hours, whichever occurs first, provided that all Mack Trucks, Inc. maintenance requirements are followed as described in this manual. All warranty periods are calculated from the date-in-service of the new vehicle. The repair or replacement of defective parts will be made without charge for the cost of parts and, if repairs are made at an authorized Mack Trucks, Inc. dealership, there will be no charge for labor.

Mack Trucks, Inc.'s obligation under this warranty is limited to the repair or replacement, at Mack Trucks, Inc.'s option, of any part(s) of Emission Control Systems of such engine and/or vehicle found to be defective upon examination by Mack Trucks, Inc. and provided that such part(s) were returned to Mack Trucks, Inc. or its nearest authorized Dealer within a reasonable period of time.

### *Qualifications and Limitations:*

**Not covered** by the Emissions Control Systems Warranty:

- Malfunctions caused by misuse, improper adjustments, modification, alteration, tampering, disconnection, improper or inadequate maintenance and use of improper diesel fuel or DEF.
- Damage resulting from accident, acts of nature or other events beyond the control of Mack Trucks, Inc.
- Inconvenience, loss of use of the vehicle, commercial loss of any kind including, but not limited to, consequential or incidental damages.
- Any vehicle in which the odometer has been altered or damaged so that mileage cannot be readily determined.

# 16 INTRODUCTION

---

**THIS WARRANTY IS EXPRESSLY IN LIEU OF ALL OTHER WARRANTIES AND REPRESENTATIONS OR CONDITIONS, STATUTORY OR OTHERWISE, EXPRESSED OR IMPLIED INCLUDING, BUT NOT LIMITED TO, IMPLIED WARRANTY OF MERCHANTABILITY OR FITNESS FOR A PARTICULAR PURPOSE.**

## Emissions Control System Warranty

The following engine components are covered by the supplemental emissions control system warranty policy as required by the California code of regulations.

- 1 Turbocharger Assembly
  - VGT Actuator
- 2 Charge Air Cooler
  - CAC Pipes (Air inlet to/from CAC)
  - CAC Hoses
- 3 Engine Control Module (ECM)
- 4 Injectors
- 5 Engine and Vehicle Wire harness  
(repair to circuits related to Emissions Warrantable Components )
- 6 Exhaust Gas Recirculation (EGR) Mixer
- 7 EGR Cooler
- 8 EGR Valve and EGR Valve Control
- 9 EGR Pipes - Engine Exhaust Manifold to EGR Cooler
- 10 EGR Pipes - EGR Cooler to Inlet Manifold
- 11 Crankcase Breather
- 12 Crankcase Separator
- 13 Crankcase Tubing and Hoses before Separator
- 14 Aftertreatment Wiring Harness
- 15 After treatment Control Module (ACM)
- 16 Aftertreatment Diesel Particulate Filter (DPF) Assembly
  - A. Aftertreatment DPF Assembly with Aftertreatment Diesel Oxidation Catalyst (DOC)
    - Aftertreatment Doser
    - Diffuser Pipe (Aftertreatment Fuel Doser Mounting)
    - Fuel lines to Aftertreatment Fuel Doser
    - Aftertreatment Fuel Shutoff Valve
    - Aftertreatment Fuel Pressure Sensor
    - Engine Turbocharger Compressor Bypass Actuator (Heat Mode)
    - Engine Turbocharger Compressor Bypass Actuator Solenoid
    - Engine Exhaust Gas Temperature (EGT) Sensor
    - Aftertreatment DPF Intake Temperature Sensor
    - Aftertreatment DPF Outlet Temperature Sensor
    - Aftertreatment DPF Differential Pressure Sensor
    - Aftertreatment Doser Air Supply Regulator (if applicable), Supply Lines, and Fittings
  - B. Thermal Regeneration Unit (TRU)
    - Aftertreatment DPF Air Shutoff Valve
    - Aftertreatment DPF Combustion Air Valve
    - Aftertreatment DPF Atomization Module
    - Aftertreatment DPF Ignition Coil

- Aftertreatment DPF Fuel Control Valve
- Aftertreatment DPF Ignition Electrode
- Nozzle
- Engine Exhaust Gas Temperature (EGT) Sensor
- Aftertreatment DPF Intake Temperature Sensor
- Aftertreatment DPF Outlet Temperature Sensor
- Aftertreatment DPF Spark Assist Flame Temperature Sensor
- Aftertreatment DPF Differential Pressure Sensor
- Aftertreatment Selective Catalytic Reduction (SCR) Catalyst
- Aftertreatment Diesel Exhaust Fluid (DEF) Pump
  - Aftertreatment DEF Dosing Absolute Pressure Sensor
  - Aftertreatment DEF Return Valve
- Aftertreatment DEF Dosing Valve
- Aftertreatment DEF Tank
- Aftertreatment DEF Tank Heater/Sender
- Aftertreatment DEF Tank Heater
- Aftertreatment DEF Tank Heater Valve

## 17 Sensors:

- Crankshaft Position (CKP)
- Camshaft Position (CMP)
- Engine Coolant Temperature (ECT)
- Intake Manifold Air Temperature
- Intake Manifold Pressure (IMP)
- EGR Temperature
- Aftertreatment Outlet NOx
- Aftertreatment Intake NOx
- EGR Differential Pressure
- Ambient Air Temperature (AAT)

## 18 SCR

19. Instrument Cluster (Repair of microprocessor , OBD MIL, Real Time Clock, Aftertreatment DEF Tank Gauge and, Aftertreatment DEF Tank Low Level Indicator)

20. Exhaust Gas Piping (from Turbocharger to Aftertreatment System )

21. Data Link Connector (DLC)



# 18 INTRODUCTION

## ENGINE GASEOUS EMISSION CONTROL SYSTEMS WARRANTY — *Continued*

The emission warranty for the diesel particulate filter (DPF) and SCR System covers defects in workmanship only. Normal maintenance, such as cleaning ash from the filter at regular maintenance intervals and cleaning the aftertreatment fuel injector on Diesel oxidation catalyst (DOC) DPF systems, is not covered by the emission warranty. With the Thermal regenerator DPF system, cleaning the ignition electrodes and fuel injection nozzle at the regular maintenance intervals is considered normal maintenance and not covered by the emission warranty.

**Note:** In response to customer requests, Mack Trucks, Inc. may build vehicles with engines supplied by other manufacturers. In these cases, each engine manufacturer through its service organization, is responsible for emission control systems warranty on all parts of the engine assembly, as furnished.



### CAUTION

Any unauthorized adjustments to the emission control components can cause severe damage to the engine.

establishment, or by the owner, using any replacement part, within the limitations of paragraphs 3 and 4 in this section. An emergency condition exists under this section if, after 30 days, repairs have not been completed or parts are not yet available. MACK will reimburse the owner for such repairs that are covered under this warranty, including diagnosis, not to exceed MACK's suggested retail price for parts replaced and labor charges based on MACK's recommended time allowance and geographically appropriate hourly labor rate. Replaced parts and paid invoices must be presented at a MACK facility as a condition of reimbursement for emergency repairs performed elsewhere.



### CAUTION

In the event that damage results from unauthorized adjustments to any emission control system components, as evidenced by settings other than as specified, or broken fastener seals, the cost of repairing such damage WILL NOT BE COVERED under warranty

### 1. Repairs by MACK Dealers, Sub-Dealers and Service Dealers

Repairs covered by the California Emission Control Systems Warranty will be performed by any authorized MACK repair facility at his place of business with no charge for parts and labor (including diagnosis), using MACK parts for any part of the emission control systems covered by this warranty and found defective.

### 2. In an Emergency

In an emergency, where an authorized MACK facility is not available, repairs may be performed at any available service

### 3. Repairs by Non-MACK Facilities

Owners may elect to have maintenance, replacement, or repair of emission control systems performed by any repair facility, and may elect to use parts other than MACK parts without invalidating the warranty on other components, but the cost of such service or parts will not be covered by MACK under its warranty.

### 4. Use of Non-MACK Parts

Use of replacement parts which are not the equivalent of MACK parts may impair the effectiveness of emission control systems. If other than MACK parts are used, the

owner should obtain assurances that such parts are warranted by their manufacturer to be the equivalent of MACK parts in performance and durability. MACK assumes no liability under this warranty with respect to parts other than MACK parts; however, the use of non-MACK parts does not invalidate the warranty on other components unless non-MACK parts cause damage to warranted parts.

## **5. Maintenance and Maintenance Records**

The vehicle owner is responsible for the performance of all required maintenance specified in this manual. MACK will not deny a warranty claim solely because there is no record of maintenance; however, MACK may deny a warranty claim if failure to perform required maintenance results in the failure of a warranted part. Receipts or other records covering the performance of scheduled maintenance should be retained to answer questions that may arise concerning maintenance. Maintenance records should be transferred to subsequent owners if the vehicle is sold.

## **6. Items Not Covered by the Emission Control Systems Warranty**

- Malfunctions caused by misuse, improper adjustments, modification, alteration, tampering, disconnection, improper or inadequate maintenance and use of improper diesel fuel.

- Damage resulting from accident, acts of nature or other events beyond the control of Mack Trucks, Inc.
- Inconvenience, loss of use of the vehicle, commercial loss of any kind including, but not limited to, consequential or incidental damages.
- Any vehicle in which the odometer has been altered or damaged so that mileage cannot be readily determined.

## **7. Customer Assistance**

MACK wishes to assure that the California Emission Control Systems Warranty is properly administered. In the event that owners do not receive the warranty service to which they believe they are entitled under the California Emission Control Systems Warranty, they should contact the nearest MACK Regional Office for assistance. The address and telephone number for each Regional Office are in the MACK Directory of Sales, Parts and Service Centers. Owners in need of additional assistance or information concerning the California Emission Control Systems Warranty may also contact:

Mack Trucks, Inc.

Warranty Activities

P.O. Box 26259

Greensboro, NC 27402

## 20 INTRODUCTION

---

### SERVICE LITERATURE

The MACK Service Publications department offers a variety of service literature (including individual service manuals) that can be ordered through any MACK dealer or on the Mack Trucks, Inc. website at [www.macktrucks.com](http://www.macktrucks.com).

**Note:** Mack Trucks, Inc. would like to emphasize the importance of proper service and maintenance procedures. Service, repair and replacements must be performed by certified, licensed mechanics in accordance with MACK standards.

### MACK Class 8 –Components Service Manual

This multi-binder set contains service information covering all MACK components (i.e., engines, transmissions, front and rear axles, cabs, fuel systems, electrical systems).

**Note:** If your vehicle contains a number of non-MACK (vendor) components, the *Class 8 – Custom Collated Service Manual* might be more appropriate.

### MACK Class 8 – Custom Collated Service Manual on CD

This tailor-made set provides complete service information for all components in the specified vehicle (including both MACK and vendor service manuals). When ordering a *Class 8 – Custom Collated Service Manual* or *Class 8 – Custom Collated Service Manual on CD*, be sure to include the complete Model-Serial number and General Sales Order (GSO) number.

---

## **CUSTOMER SERVICE**

### **Call 1-800-866-1177 for MACK OneCall™**

The OneCall customer support system is a toll-free nationwide hotline that operates 24 hours a day, seven days a week, including holidays. If you break down on the road, simply call 1-800-866-1177. There is a staff of trained, experienced technicians ready to help. They can help troubleshoot a problem to get you back on the road, arrange to send roadside assistance or arrange for towing to the nearest MACK dealership.

OneCall provides personalized service. The person who initially takes your call will be the same person who sees that your situation is resolved quickly and to your satisfaction. If a follow-up call is necessary, the same familiar voice will be on the other end of the line.

OneCall technicians can also help you plan ahead to keep your operation running efficiently by scheduling routine maintenance and lubrication service, or by locating the nearest MACK dealership.

### **Questions and Complaints**

Your satisfaction is our most important concern.

If questions or complaints arise, first discuss the matter with the service manager at the MACK facility involved. If you are not satisfied with the service manager's response, contact the branch manager, principal or general manager of the distributorship. If assistance is required at a service dealer, contact the owner of the establishment.

If, for any reason, you need further assistance after dealing with the personnel at a MACK subsidiary or distributor, contact the regional service manager at the nearest MACK regional service office. The regional service manager has the responsibility and the authority to recommend action in most cases and (with the aid of relevant district service personnel) will make every effort to conduct a fair review of the situation.

## 22 INTRODUCTION

---

### Addresses

The addresses, telephone and fax numbers of the Mack Trucks, Inc. regional offices are:

#### *United States*

**Northeast Region** – 7900 National Service Road., Mail: P.O. Box 26259, Greensboro NC 27402 , TEL: (336) 291-9001

**Southeast Region** – 6768 Southlake Parkway, Morrow, GA 30260, TEL: (770) 960-0511, FAX: (770) 960-0593

**Central Region** –900 S. Frontage Rd., Suite 100, Woodridge, IL 60517, TEL: (630) 910-3330, FAX: (630) 910-3331

**Southwestern and Western Regions** – 5605 N. MacArthur Blvd., #550, Mail: P.O. Box 165408, Irving, TX 75016-5408, TEL: (972) 518-1614, FAX: (972) 550-0389

#### *Canada*

**Executive Office** – Mack Canada, Inc., 5600A Cancross Court, Mississauga, ON L5R 3E9, TEL: (905) 366-3400, FAX: (905) 366-0165

#### *Australia*

Mack Trucks Australia Pty. Ltd., CNR Archerfield and Boundary Roads, Mail: P.O. Box 364, Richlands, QLD 4077, Australia, TEL: 61-7-3853-3333, FAX: 61-7-3853-3392

#### *International*

7900 National Service Road., Mail: P.O. Box 26259, Greensboro NC 27402 , TEL: (336) 291-9001

### Additional Assistance

If additional assistance is required, Mack Trucks, Inc. maintains a Customer Service Department (staffed by experienced personnel) to aid customers who need information or assistance not provided at the local or regional level.

The Customer Service Department phone number is **(610) 709-3961**.

When contacting the regional service offices or Customer Service Department, provide the following information:

- Vehicle Identification Number (VIN) — This 17-digit number is typically located on a label on the driver-side door latch post and behind the front axle on the right, front frame rail.

- Model and year of the vehicle
- Date that the vehicle was purchased and put into service
- Date(s) and mileage of repair(s)
- Dealer that sold and/or serviced the vehicle
- Description of unresolved service complaint or inquiry
- Summary of action taken to date (by the dealer and the regional service office)
- Names of individuals (if known) contacted at the dealer and the Mack Trucks, Inc. regional service office.

## 24 INTRODUCTION

---

### REPORTING SAFETY DEFECTS

#### United States

If you believe that your vehicle has a defect which could cause a crash, injury or death, you should immediately inform the National Highway Traffic Safety Administration (NHTSA), in addition to notifying Mack Trucks, Inc.

If NHTSA receives similar complaints, it may open an investigation and if it finds that a safety defect exists in a group of vehicles, it may order a recall and remedy campaign. However, NHTSA cannot become involved in individual problems between you, your distributor, or Mack Trucks, Inc.

To contact NHTSA, either call the U.S. Government's Vehicle Safety Hotline toll-free at 1-888-327-4236 (TTY: 1-800-424-9153); go to <http://www.NHTSA.gov>; or write to: Administrator, National Highway Traffic Safety Administration, 400 Seventh Street, S.W., Washington, DC 20590. You can also obtain other information about motor vehicle safety from the Vehicle Safety Hotline.

#### Canada

Canadian customers who wish to report a safety-related defect to Transport Canada — Defect Investigations and Recalls, may telephone the toll free hotline at 1-800-333-0510, or contact Transport Canada by mail at Transport Canada, ASFAD, Place de Ville Tower C, 330 Sparks Street, Ottawa ON K1A 0N5. For additional road safety information, please visit the Road Safety website at <http://www.tc.gc.ca/roadsafety/menu.htm>.

#### Mexico

Volvo Trucks de Mexico, S.A. de C.V. should be informed immediately if you believe the vehicle has a defect that could cause a vehicle accident, injury or death. Contact Volvo Trucks de Mexico by calling 011-52-55-50-81-68-50 or by writing to: Volvo Trucks de Mexico, S.A. de C.V., Prol. Paseo de la Reforma 600, 1er. Piso — 121, Col. Santa Fe Pena Blanca, C.P. 01210, Mexico, D.F. Within Mexico, call 01 (800) 90 94 900.

## **EVENT DATA RECORDING DEVICES**

Your Mack vehicle is equipped with a device generally referred to as an "event data recorder" or "EDR." Please note that while the term "event data recorder" is typically used throughout the motor vehicle industry, not every EDR is the same; i.e., they do not all record the same data elements. The EDR on your MACK vehicle records vehicle speed, engine rpm, time and date, plus a variety of pedal and switch positions, both before and after an "event." Sudden vehicle deceleration or the occurrence of certain other vehicle operational characteristics will define (trigger) an "event."

Optional equipment available for your MACK vehicle, such as the Eaton® VORAD® Collision Warning System, may also provide event data recording features.

If you have a question about your EDR, please contact your MACK dealer or regional service office.



## 26 SAFETY INFORMATION

---

### SAFETY STATEMENT

Mack Trucks, Inc. cannot anticipate every possible occurrence which may involve a potential hazard. An accident can be avoided by recognizing potentially hazardous situations before a dangerous situation occurs. Correctly performed service procedures are critical for technician safety and safe, reliable operation of the vehicle.



#### **DANGER**

Do not operate the engine in an enclosed area. All internal combustion engines give off various fumes and gases while running. Inhalation of exhaust fumes can cause death.



#### **DANGER**

Do not sit in a parked vehicle for any extended amount of time with the engine running if there are leaks in the exhaust system. Exhaust fumes could leak into the cab area and death can result. On a regular basis inspect the exhaust system for leaks and repair any leakage.



#### **DANGER**

Driver attitude is the most important part of any effective vehicle safety system. Mack Trucks, Inc. strongly encourages all drivers and passengers to use their seat belts, drive defensively, remain alert and respect the speed limits. Many accidents can also be avoided through regular vehicle maintenance.



#### **DANGER**

Engine-driven components such as Power Take-Off (PTO) units, fans and fan belts, driveshafts and other related rotating assemblies, can be very dangerous. Do not service engine-driven components unless the engine is shut down. Always keep body parts and loose clothing out of range of these powerful components to prevent serious personal injury. Be aware of PTO engagement or nonengagement status. Always disengage the PTO when not in use.



## WARNING

Certain everyday procedures such as washing the vehicle and cleaning the windshield can also be hazardous because of the vehicle's height. Mack Trucks, Inc. does NOT recommend climbing up on the vehicle to perform these operations. Instead, stand on the ground and use brushes and squeegees mounted on extension poles. When better access is necessary (for instance, when washing the cab roof), use sturdy ladders held in place by someone on the ground.



## WARNING

Secure loose objects. Loose objects in the cab or sleeper can be dangerous in a sudden stop or on bad roads. Secure any appliance added to the vehicle, such as a refrigerator or a radio.



## WARNING

Keep clear of fan when engine is running. Fan may start to rotate at high speed without warning.

# 28 SAFETY INFORMATION

## CERTIFICATION LABELS

### Safety Certification Label

National Highway Traffic Safety Administration (NHTSA) regulations require affixing a certification label to all vehicles.

NHTSA regulations also require that the certification label be affixed to either the hinge pillar, door latch post or the door edge that meets the door latch post next to the driver seat. If none of these locations are practical, it may be attached to the left side of the instrument panel or to an inward facing surface of the driver-side door.

In compliance with NHTSA regulations, your Mack® vehicle has a safety certification label affixed in one of the NHTSA locations listed above. This label may be either an Incomplete Vehicle and/or Completed Vehicle label. Both labels are described below.

#### Incomplete Vehicles

	INCOMPLETE VEHICLE MANUFACTURED IN 05/2005 BY MACK TRUCKS, INC.		
	VEHICLE IDENTIFICATION NUMBER: 1M2AD65CX6M001944	GVWR:	40371 KG (89000 LB)
	GAWR — FRONT AXLE:		9072 KG (20000 LB)
	GAWR — 1ST INTERMEDIATE AXLE:		10433 KG (23000 LB)
	GAWR — 2ND INTERMEDIATE AXLE:		10433 KG (23000 LB)
	GAWR — 3RD INTERMEDIATE AXLE:		KG ( LB)
	GAWR — 4TH INTERMEDIATE AXLE:		KG ( LB)
	GAWR — 5TH INTERMEDIATE AXLE:		KG ( LB)
	GAWR — REAR AXLE:		10433 KG (23000 LB)

 	INCOMPLETE VEHICLE (VÉHICULE INCOMPLÉTI) MANUFACTURED IN 08/2005 BY MACK TRUCKS, INC.		
	VEHICLE IDENTIFICATION NUMBER: 1M2AL01C56M001386	GVWR/PNBV:	37194 KG
	GAWR/PNBE — FRONT AXLE:		9072 KG
	GAWR/PNBE — 1ST INTERMEDIATE AXLE:		5443 KG
	GAWR/PNBE — 2ND INTERMEDIATE AXLE:		5443 KG
	GAWR/PNBE — 3RD INTERMEDIATE AXLE:		8618 KG
	GAWR/PNBE — 4TH INTERMEDIATE AXLE:		KG
	GAWR/PNBE — 5TH INTERMEDIATE AXLE:		KG
	GAWR/PNBE — REAR AXLE:		8618 KG

C0028955

A chassis-cab is an incomplete vehicle with a completed occupant compartment that requires the addition of cargo-carrying, work-performing or load-bearing components to perform its intended functions.

The chassis-cab manufacturer must affix a label to the incomplete vehicle in one of the NHTSA locations listed above. This label provides the chassis-cab date of manufacture, VIN and vehicle certification information.

## Completed Vehicles

In addition to the label supplied by Mack Trucks, Inc. as the chassis-cab manufacturer, a Completed Vehicle certification label, supplied by the body manufacturer, is affixed in the same general location. This label provides information pertaining to Gross Vehicle Weight Rating (GVWR), Gross Axle Weight Rating (GAWR), tire and rim information, etc.

On **MACK-completed vehicles**, this label contains the date of manufacture, VIN, GVWR, GAWR, and tire and rim data. It is found in one of the NHTSA locations listed above.

	MANUFACTURED BY MACK TRUCKS, INC. IN 11/2005	GVWR 23587 KG ( 52000 LB )
	THIS VEHICLE CONFORMS TO ALL APPLICABLE U.S. FEDERAL MOTOR VEHICLE SAFETY STANDARDS IN EFFECT ON THE DATE OF MANUFACTURE SHOWN ABOVE. VEHICLE IDENTIFICATION NUMBER: 1M1AK06Y76N012587	
	<u>GAWR</u>	<u>TIRES</u>
FRONT:	5443 KG ( 12000 LB )	WITH 11R22.5 G, 22.5 X 8.25 , AT 827 KPA ( 100 PSI) COLD SINGLE
1ST INT:	9072 KG ( 20000 LB )	WITH 11R22.5 G, 22.5 X 8.25 , AT 724 KPA ( 100 PSI) COLD DUAL
2ND INT:	KG ( LB )	WITH TIRES, RIMS, KPA ( PSI) COLD
3RD INT:	KG ( LB )	WITH TIRES, RIMS, KPA ( PSI) COLD
REAR MOST:	9072 KG ( 20000 LB )	WITH 11R22.5 G, 22.5 X 8.25 , AT 724 KPA ( 100 PSI) COLD DUAL
VEHICLE TYPE:	TRUCK TRACTOR	

	MANUFACTURED IN 09/2005 BY MACK TRUCKS, INC.	
	VEHICLE IDENTIFICATION NUMBER: 1M1AP02Y06N001003	
GVWR/PNBV:	29938 KG	VEHICLE TYPE: TRUCK-TRACTOR/CAMION TRACTEUR
GAWR/PNBE — FRONT:	9072 KG WITH 425/65R22.5L TIRES, 22.5 X 12.25	RIMS, 827 KPA COLD SINGLE
GAWR/PNBE — 1ST INT:	10433 KG WITH 11R24.5 G TIRES, 24.5 X 8.25	RIMS, 724 KPA COLD DUAL
GAWR/PNBE — 2ND INT:	KG WITH TIRES, RIMS,	KPA COLD
GAWR/PNBE — 3RD INT:	KG WITH TIRES, RIMS,	KPA COLD
GAWR/PNBE — REAR:	10433 KG WITH 11R24.5 G TIRES, 24.5 X 8.25	RIMS, 724 KPA COLD DUAL



# 30 SAFETY INFORMATION

## ADVISORY LABELS

Throughout this book you will find paragraphs labeled *Danger, Warning, Caution, Note and Service Hint*. *Danger, Caution and Warning* labels are also found in various locations on the vehicle to alert drivers, operators and service technicians to situations which can cause personal injury or equipment damage. The labels shown are applicable to the Mack® TerraPro™ LEU model chassis at the time of publication and are representative of what can be typically found on a Mack® TerraPro™ LEU. (Your vehicle may not contain all of the labels illustrated in this handbook.) These labels are for your benefit. Please look through this section and note the labels, their locations and what they explain. Be sure to replace any label that is damaged.

## Advisory Label Locations (On Vehicle)

### Labels Found on Chassis

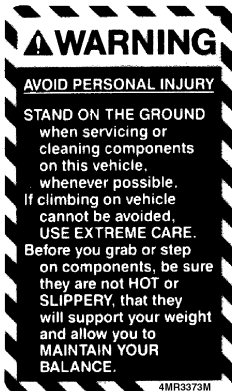
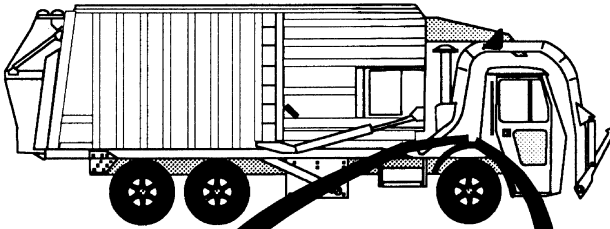

4MR3373M

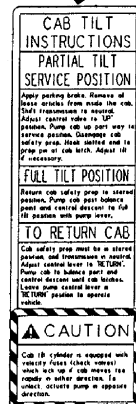

4MR3372M

4MR3382  
(IF APPLICABLE)



**WARNING**

Avoid personal injury and equipment damage. Driveline retarder rotors may be very hot. Keep air lines, wiring, tubing, etc., at least 4 inches from retarder rotors.

4MR3382

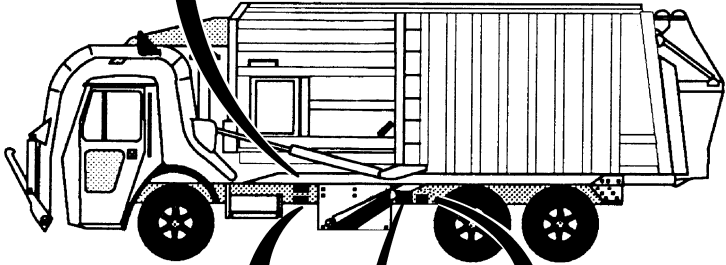
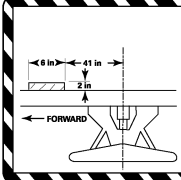



**NOTICE**

**BODY INSTALLER:**  
Avoid equipment damage. Driveline retarder rotors may extend above frame rails under some conditions. Provide clearance in the area shown in the picture. Area extends 11 in. each side of chassis centerline.

4MR3384

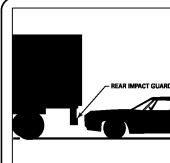
4MR3384  
(IF APPLICABLE)



**NOTICE**

Depending upon the final configuration of the rear of this vehicle, federal or state regulations may require the addition of an appropriate rear impact guard for underdrive protection. Refer to Federal Motor Carrier Safety Regulation 393.86 (49 CFR 393.86) or any applicable state regulation.

4MR21061

4MR21061

**ADVERTENCIA**      **CAUTION**

El bastidor está tratado térmicamente.	Frame is heat-treated.
Para evitar daños al bastidor, NO SE DEBE calentar ni soldar. TAMPOCO SE DEBEN perforar, cortar ni limar los patines del bastidor.	To avoid frame damage, do NOT heat or weld, do NOT drill, cut or notch frame flange.

21155711

21155711

# 32 SAFETY INFORMATION

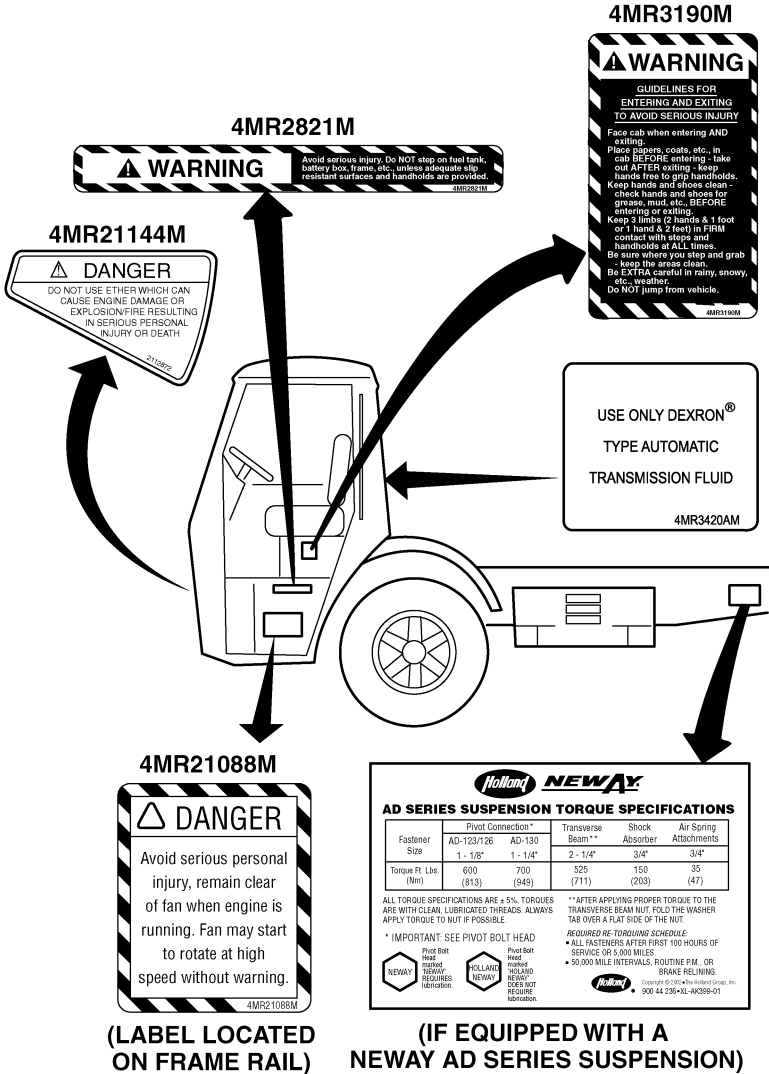

(LABEL LOCATED ON FRAME RAIL)

(IF EQUIPPED WITH A NEWAY AD SERIES SUSPENSION)

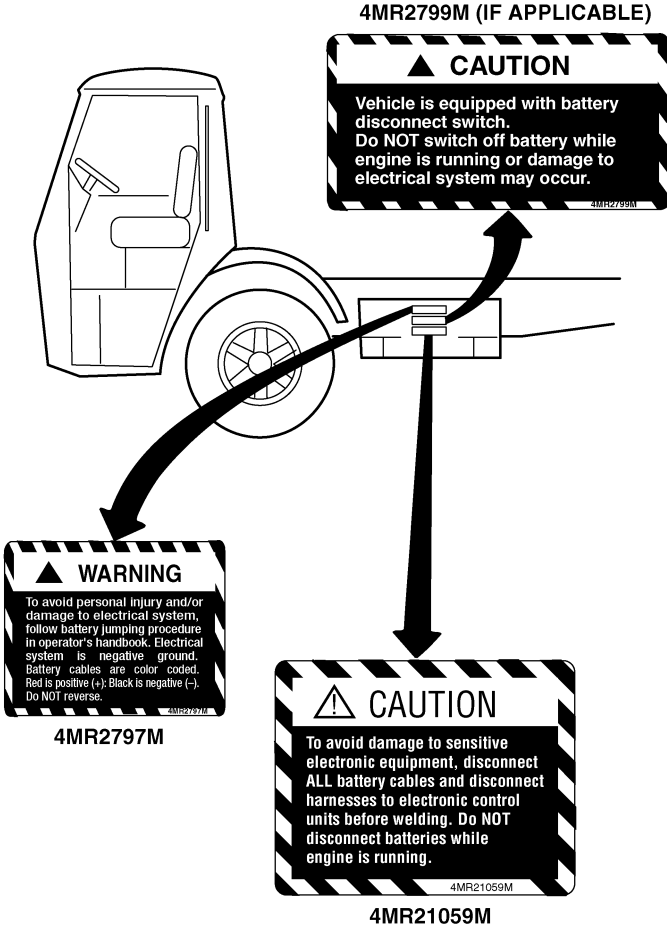



# 34 SAFETY INFORMATION

Li

**⚠ DANGER**

**High Exhaust System Temperature**

Exhaust gases and components are at extremely high temperatures. When parking the vehicle, keep away from people, or any flammable materials, vapors, or structures.

21047095

**21047095  
(IF APPLICABLE)**

**⚠ CAUTION**

**THIS CHASSIS IS EQUIPPED WITH SPEED RESTRICTED TIRES WHICH LIMIT MAXIMUM HIGHWAY SPEED.**

PLEASE CONSULT THE DOCUMENT PROVIDED WITH THIS VEHICLE FOR SPECIFIC INSTRUCTIONS FOR THE TIRES SUPPLIED WITH THIS VEHICLE OR CONSULT THE TIRE MANUFACTURER FOR OPERATION INSTRUCTIONS.

4MR2796

**4MR2796  
(IF APPLICABLE)**

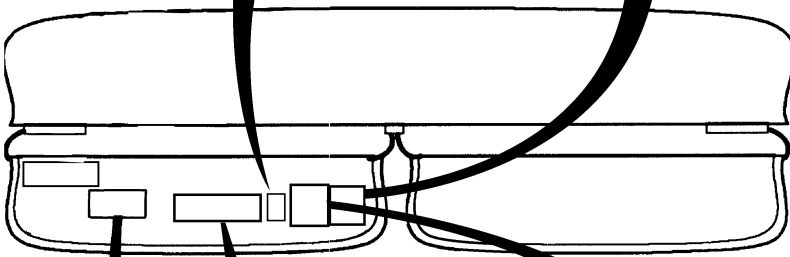

EXHAUST AFTERTREATMENT SYSTEM (ATS) INFORMATION				
Indicators	LEVEL 1	LEVEL 2	LEVEL 3	LEVEL 4
ATS Condition	Regeneration needed	Regeneration Required	Regeneration needed immediately Engine decelerate active	ATS service required Service engine decelerate active
Action To Be Taken	Manually initiate regeneration or begin driving to allow automatic regeneration to prevent entering Level 2.	Manually initiate regeneration or begin driving to allow automatic regeneration to prevent entering Level 3.	Perform a Planned Regeneration IMMEDIATELY to prevent further engine decelerate and entering Level 4.	Send service immediately. Service Regeneration is required.
ATS control switch: 1) Depress upper portion to initiate or manually initiate regeneration. 2) Depress lower portion to inhibit or cancel regeneration.				
* See Operator's Manual for Further Details				
WARNING! Failure to follow these instructions may result in a loss of engine power, vehicle speed, high temperatures, and may cause an accident or fire resulting in property damage, personal injury or death. 21061146				

**21061146  
(IF EQUIPPED)**

**⚠ DANGER**

Rotating PTO shaft can snag clothes, limbs, etc., causing severe personal injury or death (or avoid injury or death). Do NOT go near rotating shaft when engine is running. STOP engine before attempting to work on PTO. Use controls on related equipment.

**4MR2927  
(IF APPLICABLE)**

**⚠ WARNING**

BEFORE STARTING ENGINE: to prevent vehicle from suddenly jumping and to avoid personal injury and vehicle damage, make sure parking brakes are applied, push in clutch pedal and place gear shift in neutral.

Avoid turbocharger damage when starting engine by NOT running engine above 1400 rpm UNTIL oil pressure is over 20 psi (138 kPa).

To avoid driveline damage, do NOT attempt to move vehicle when parking brake lamp is on.

Engine operation range is \_\_\_\_\_ rpm. Prevent drivetrain damage by NOT starting engine over \_\_\_\_\_ rpm.

BEFORE STOPPING ENGINE: to avoid turbocharger damage, idle engine 2 minutes.

4MR3211M

**4MR3211M**

Labels Found on Cowl (Near Ashtray)

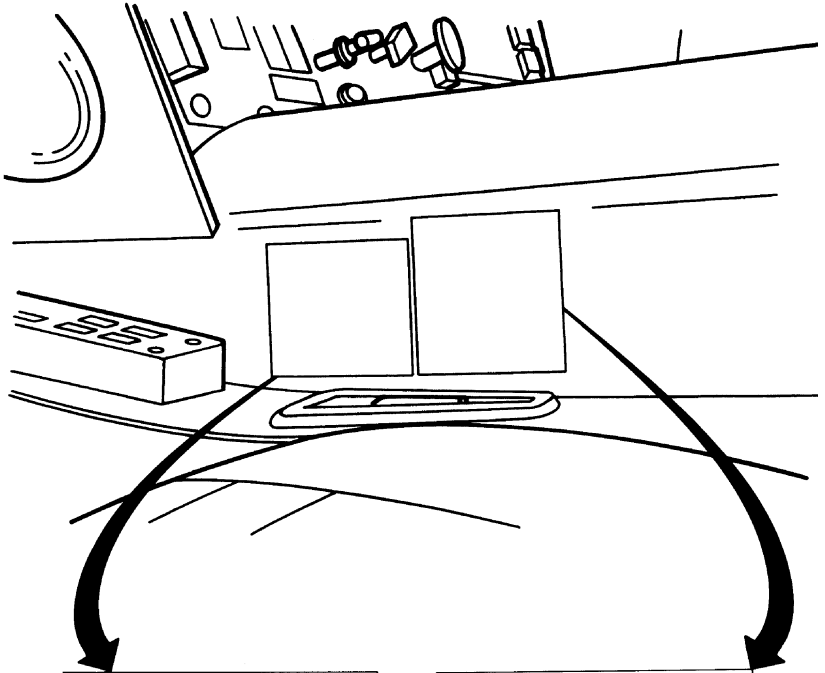

**NOTICE**

THIS VEHICLE IS EQUIPPED WITH A TRANSMISSION SHIFTER NEUTRAL INHIBITOR SYSTEM. NEUTRAL TO DRIVE RANGE SHIFTS ARE AUTOMATICALLY PREVENTED AT HIGH ENGINE SPEEDS. AFTER COMPLETING NEUTRAL PTO OPERATION REDUCE ENGINE SPEED TO BELOW 900 RPM TO ALLOW NEUTRAL TO RANGE SHIFT.

4MR2860

**4MR2860**

**NOTE**

For your comfort, seat belts are equipped with a tension - relieving device. It can be used to provide a small amount of slack in seat belt to reduce pressure against your shoulder and chest. To use the device, CAREFULLY follow instructions in Operator's Handbook and on face of device.

**⚠ DANGER**

Excessive slack will reduce effectiveness of seat belt which could result in personal injury and death. CAREFULLY follow instructions for adjusting tension - relieving device.

4MR2967M

**4MR2967M**

# 36 SAFETY INFORMATION

## Labels Found on Instrument Panel

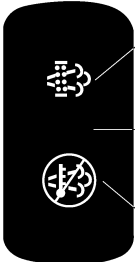
 <p>MANUAL</p> <p>AUTO</p> <p>INHIBIT (RSL)</p>	<p><b>⚠ CAUTION</b></p> <p>Use INHIBIT only to temporarily prevent DPF regeneration. Road Speed Limit (RSL) will occur in INHIBIT position. Return switch to AUTO or MANUAL as soon as possible to avoid engine or exhaust aftertreatment system problems. See Operator's Handbook for details. Questions or Assistance call: 1-800-866-1177</p> <p><small>82186054</small></p>
--	---

C0029017

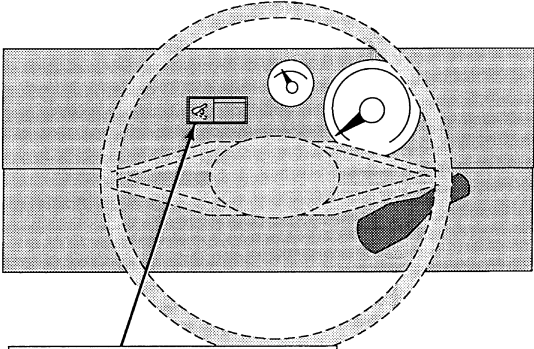

### WORK BRAKE WARNING LABEL

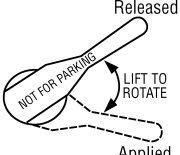
<p>WORK BRAKE</p> <p>Released</p>  <p>Applied</p>	<p><b>⚠ WARNING</b></p> <p>Avoid personal injury from possible loss of vehicle control. Stop vehicle completely with foot brake before applying work brake. See Operators Handbook for more information.</p>
--	--

4MR3287AM

C0029562



# 38 SAFETY INFORMATION

---

## *Back Up Alarm (Optional)*

Your chassis may be equipped with an optional back up alarm. If so, the following label will appear inside the cab.



C0029022

C0029563

---

## CAB ENTRY/EXIT

### Three-Limb Contact



#### WARNING

When entering or exiting a cab, the driver and/or passenger must have at least three limbs in contact with the vehicle or ground at all times. This means that a minimum of two hands and one foot, or one hand and two feet must be in FIRM contact with the vehicle or ground.



#### WARNING

When entering or exiting the cab, be aware of the condition of the steps and handrails. Clean any fuel, oil or grease off of the steps before entering the cab. During cold weather operation, ice and snow may accumulate and should be cleaned off to prevent slipping.

During cold, wet conditions when ice, slush, or snow may accumulate on the cab doorstep and other external surfaces, extra caution must be observed when entering or exiting the cab.



#### WARNING

#### **GUIDELINES FOR ENTERING AND EXITING TO AVOID SERIOUS INJURY**

- Face the cab when entering AND exiting.
- Place papers, coats, etc., in cab BEFORE entering. Take out AFTER exiting. Keep hands free to grip handholds.
- Keep hands and shoes clean. Check hands and shoes for grease, mud, etc., BEFORE entering or exiting.
- Keep 3 limbs (2 hands and 1 foot or 1 hand and 2 feet) in FIRM contact with steps and handholds at ALL times.
- Be sure of where you step and grab the handholds. Keep the areas clean.
- Be EXTRA careful in rainy, snowy, etc., weather.
- Do NOT jump from vehicle.

## 40 SAFETY INFORMATION

---

**Note:** The illustrations on the following pages are typical for purposes of emphasizing a safe method for hand/foot placement and movement during cab entry/exit. Your vehicle may not look exactly like the one pictured.

**Note:** The arrows in the illustrations are intended to show movement. Notice that three-limb contact is maintained even when one foot, or one hand, is moving.

## Driver Side

The following cab entry and exit procedures, along with the safety guidelines outlined in Three-Limb Contact earlier in this section, should be used with this MACK vehicle.

### ***Entry***

These entry procedures are illustrated on the following page:

- 1 With both feet firmly on the ground, grab the outside handhold with one hand and grab the inside handhold with the other hand. Then raise one foot to the bottom step. (See figure 1.)
- 2 Move hand [1] from the inside handhold to the steering wheel, then raise your other foot to the cab floor. (See figure 2.)
- 3 Move hand [2] from the outside handhold to the steering wheel. (See figure 3.)
- 4 Bring the other foot inside the cab and sit down. (See figure 4.)

### ***Exit***

To exit, follow the illustrations in reverse order:

- 1 With both hands gripping the steering wheel, stand up and face the inside of the cab. Move one foot to the bottom step. (See figure 4.)
- 2 Move one hand to the outside handhold and continue to grip the steering wheel with the other hand. (See figure 3.)
- 3 With one foot firmly on the bottom step, lower the other foot to the ground. (See figure 2.)
- 4 With both hands firmly gripping the handholds, lower the other foot to the ground. (See figure 1.)



# 42 SAFETY INFORMATION

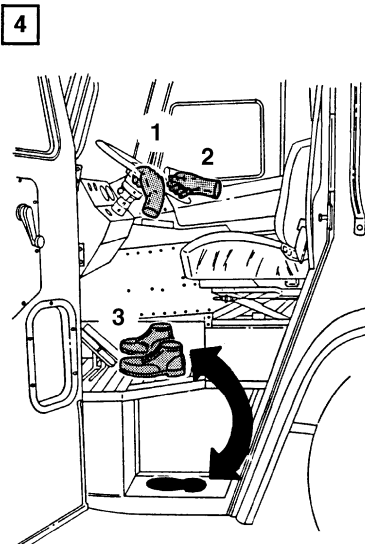
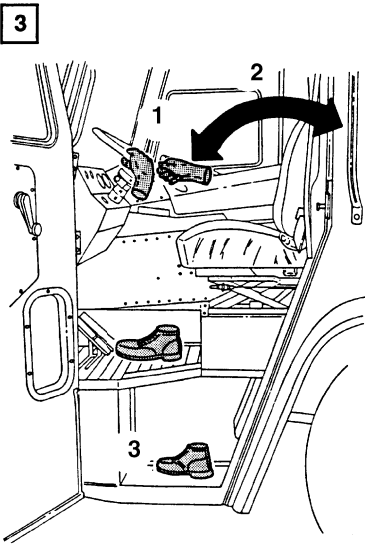
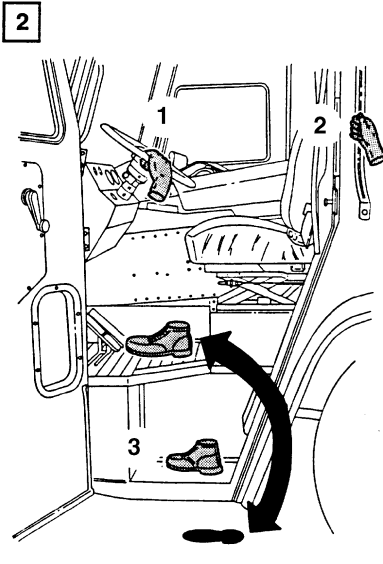
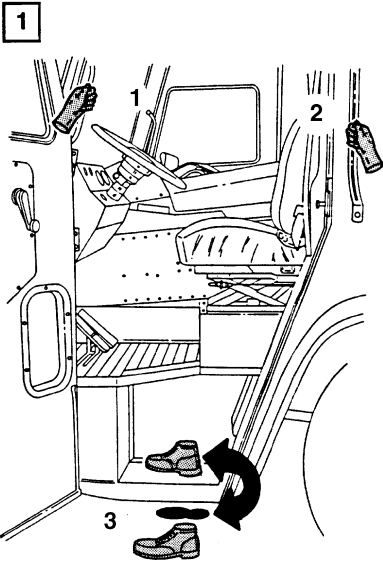

## Passenger Side

The following cab entry and exit procedures, along with the safety guidelines outlined in the Three-Limb Contact section, should be used with this MACK vehicle.

### Entry

These entry procedures are illustrated on the following page:

- 1 Grab the handhold with one hand, and place the other hand on the steering wheel. Do not use the folding door as a handhold. Raise one foot to the cab floor. (See figure 1.)
- 2 While still gripping the handhold and the steering wheel, move the other foot into the cab. (See figure 2.)

### Exit

To exit, follow the illustrations in reverse order:

- 1 Grip the handhold with one hand, and the steering wheel with the other hand. Then move one foot to the ground. (See figure 2.)
- 2 While still gripping the handhold and steering wheel, move the other foot to the ground. (See figure 1.)

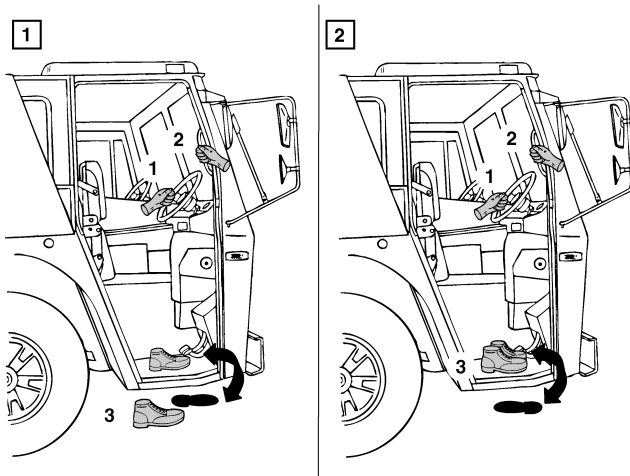

## 44 SAFETY INFORMATION

### SAFETY TIPS FOR COLD WEATHER OPERATION

#### Driver Visibility

Poor driver visibility is not only annoying, but extremely unsafe under any circumstance. Without proper maintenance of visibility-related components, adverse weather conditions such as rain, snow and frost can seriously reduce visibility. Take time before winter arrives to check the following:

- Windshield Wipers
  - Check windshield wiper operation and speeds.
  - Inspect condition and travel of blades. Install new refills for any blades that are cracked, brittle, torn, or coated with road oil along the wiping edge.
- Windshield Washers
  - Check operation of windshield washer.
  - Inspect system hoses and replace if brittle or worn.
  - Inspect washer reservoir. Drain and flush if dirt particles are evident in washer solution.
  - Fill reservoir with commercially available non-freezing type washer fluid.



#### CAUTION

*Do NOT fill reservoir with water only. Even though non-freezing type washer fluid is recommended, do not attempt to clear the windshield of ice by activating the windshield washer and wipers. Ice accumulations should be removed manually by using a scraper.*

- Heater/Defroster
  - Check operation and blowers for speed control, noise and temperature.
  - Inspect heater core for signs of corrosion and/or leakage.
  - Check that the defroster blend door is operating correctly and that all ducting is connected properly.
  - Be sure that vents are not obstructed by debris or other objects.

## Cab Door Seals and Key Locks

Hollow-core rubber weather seals around some cab doors may lose their resilience in extremely cold temperatures (i.e.,  $-40^{\circ}\text{C}/-40^{\circ}\text{F}$  and below). Under these conditions, it may be necessary to drill holes to penetrate the hollow core. This allows entrapped air to escape, thereby easing the opening/closing of cab door(s).

Be sure to keep the key locks clean and dry to prevent occasional winter freeze-up. Use of antifreeze lubricants is neither required nor recommended.

## Outside Mirror Heater

In areas of frequent snowfall and ice, it may be beneficial to install heated mirrors which will defrost and de-ice cab mirrors. Heated mirrors eliminate the need to pull off the highway and stand on the roadside to scrape ice and snow from the mirrors during winter driving conditions. Heated mirrors are available either cab mounted or fender mounted.

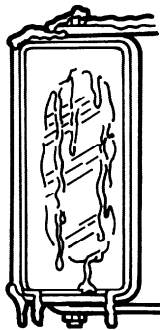

## 46 SAFETY INFORMATION

---

### Air Horn Snow Shield

Installation of an air horn snow shield is recommended to prevent snow from clogging the air horn bell (maintaining maximum sound output).

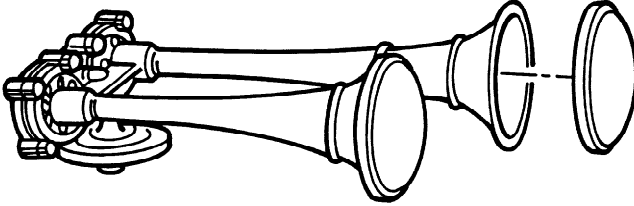

C0029133

### Fire Extinguisher (Optional)

Your vehicle may be equipped with a fire extinguisher which is located inside your cab. Check your fire extinguisher regularly to make sure it is fully charged.

## CAB INTERIOR — LEFT

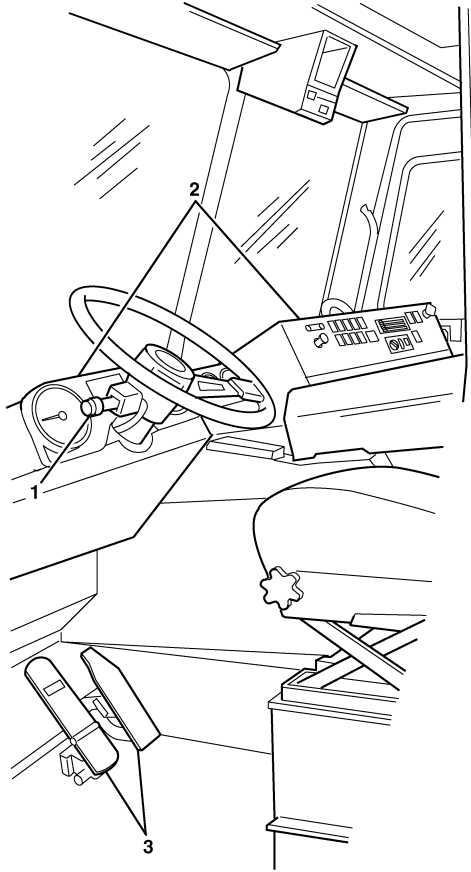

C0029566

1. Turn Signal, Hazard Switch and HI/LO Beam

2. Instrument Panels

3. Foot Pedals

# 48 INSTRUMENTS AND CONTROLS

## CAB INTERIOR — RIGHT

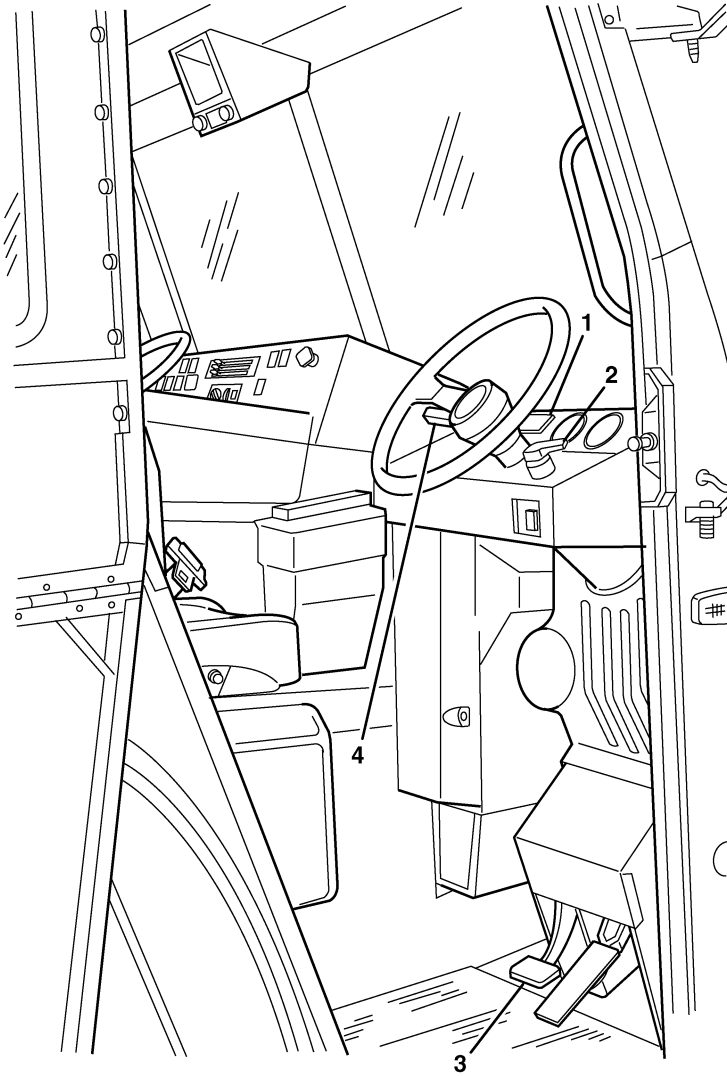

C0029567

1. Instrument Panels

2. Work Brake

3. Foot Pedals

4. Turn Signal, Hazard Switch and HI/LO Beam

## INSTRUMENT PANEL

### Tell-Tales

A tell-tale is a display that indicates the actuation of a device, a correct or defective condition, or a failure to function.

The operator should become familiar with these symbols in order to recognize and react (if necessary) to the indicated condition. Tell-tale symbols are shown in the instrument panel illustrations on the following pages.

#### **Colors**

To promote visual recognition internationally, specific colors for tell-tales have been established. Unless governmental regulations (in the area where the vehicle is to be used) or engineering directives specify otherwise, the standard colors are:

- **Blue** – high-beam headlights/engine maintenance
- **Flashing Green** – turn signals
- **Flashing Red** – hazard condition involving the safety of personnel
- **Steady Green** – system in operation
- **Steady Red** – warning, immediate action required
- **Amber** – early warning, such as low fuel or Anti-Lock Brake System (ABS) malfunction



### Panel Arrangement

Your view from the driver seat should look something like the illustrations shown. The layout is designed to provide the operator with a good view of the gauges and controls (which are placed so they are within easy reach). The instrument panel, as shown in the following drawing, is broken down into several main sections. For easy identification we refer to them, from left to right, as Panels A, B, C, D, E and F (where necessary).

**Note:** This section shows the instruments and controls available for this vehicle at the time of publication. However, depending on options, your vehicle may not have all the instruments and controls shown here, and they may not be in the same position.

## INSTRUMENT PANEL GAUGE LAYOUT

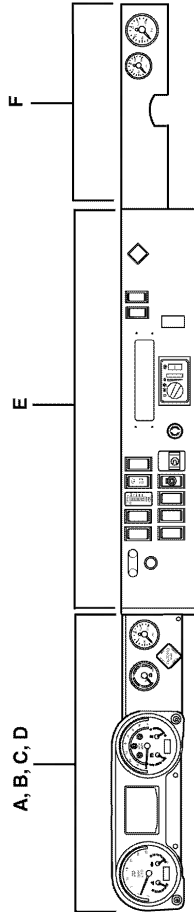

# 52 INSTRUMENTS AND CONTROLS

## Panels A, B, C and D

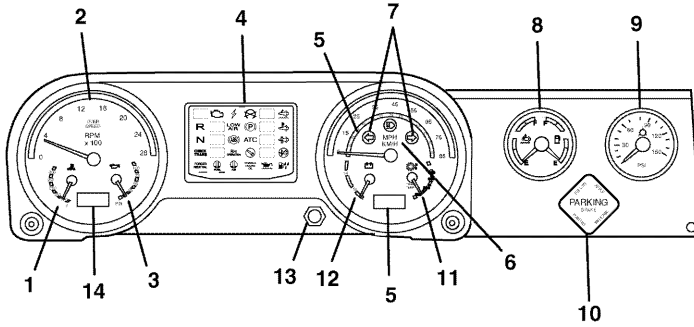

W3056177

- |                                 |  |
|---------------------------------|--|
| 1. Coolant Temperature Gauge    | 8. DEF Gauge/Fuel Gauge                |
| 2. Tachometer                   | 9. Air Pressure Gauge                  |
| 3. Oil Pressure Gauge           | 10. Parking Brake Valve                |
| 4. Warning/Indicator Lamp Panel | 11. Transmission Oil Temperature Gauge |
| 5. Speedometer/Odometer         | 12. Voltmeter                          |
| 6. High Beam Indicator          | 13. Mode Button                        |
| 7. Turn Signal Indicators       | 14. Hour Meter                         |

## Panel E

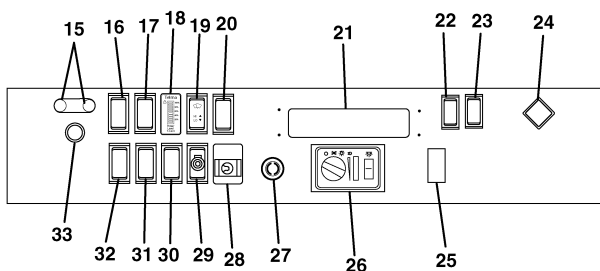

C0029589

15. CB Radio Auxiliary Hookup	25. Auxiliary Switch — Body Function
16. DPF Smart Switch (If Equipped)	26. Light Control Panel
17. Inter-Axle Power Divider Lockout Switch (If Equipped)	27. Combination Starter and Electrical Switch
18. Telma Rear Axle Mounted Retarder (If Equipped)	28. Right-Hand Operation Switch
19. Windshield Wiper/Washer Control Switch	29. Moto-Mirror Switch (If Equipped)
20. Automatic Traction Control Switch/Heavy Mud/Snow	30. Heated Mirror Switch (If Equipped)
21. Cab Climate Control Panel	31. Resume/Set Switch
22. Power Take-Off Control Switch (If Equipped)	32. Speed Control Switch
23. Auxiliary Switch — Body Function	33. Cigar Lighter or Accessory Power Outlet
24. Parking Brake Valve	

**Note:** If equipped with Automatic Traction Control (ATC), the control switch will be located on instrument panel E. Refer to “Automatic Traction Control (ATC) (If Equipped)”, page 130 of the *OPERATION* section of this manual for ATC operation and heavy mud/snow option.

# 54 INSTRUMENTS AND CONTROLS

## Panel F

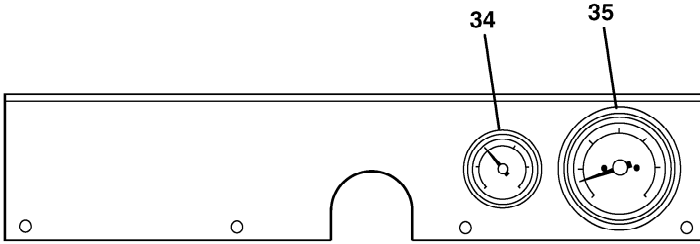

C0029590

34. Air Pressure Gauge

35. Speedometer/Odometer

**1. Coolant Temperature Gauge** — Indicates the temperature of the engine coolant. The normal operating temperature for MACK MP7 engine is between 77°C and 107°C (170°F and 225°F). The driver will receive a warning if coolant temperature reaches 223°F and engine shutdown will occur at 227°F if the engine coolant temperature shut down option is enabled.



### CAUTION

*Coolant temperature must NOT exceed 107°C (225°F).*

**2. Tachometer** — Indicates engine speed in revolutions per minute (RPM). Tachometer readings should be used as a guide for shifting, as well as to prevent engine damage due to overspeed. The blue band indicates the optimum range for engine brake operation.

**3. Oil Pressure Gauge** — Indicates engine oil pressure. The normal operating oil pressure for a MACK MP7 engine (at governed speed) is between 275.8 and 620.5 kPa (40 and 90 psi). At idling speed, the oil pressure should be between 275.8 and 413.9 kPa (40 and 60 psi).

Should the oil pressure drop suddenly from normal readings, stop the engine immediately and determine the cause.

**4. Warning/Indicator Lamp Panel** – Items listed below from left to right and top to bottom.

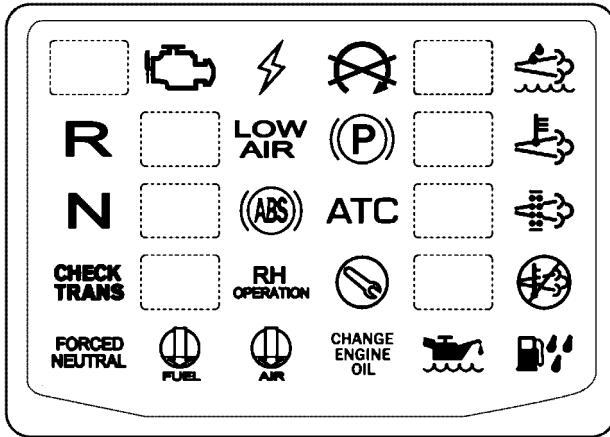

W3056178

### Detail of Warning/Indicator Light Panel – LH

- **Optional Tell-Tales**
- **Malfunction Indicator lamp (MIL)** — MIL indicates government Regulation On Board Diagnostics (OBD) faults. Lamp remains active after repair until system operation confirms repair.
- **Electronic Malfunction Indicator (Amber)** — Illuminates when V-MAC® detects an electronic malfunction. Refer to the appropriate V-MAC® Operator's Guide for details.
- **Engine Shutdown Indicator (Red)** — Indicates the occurrence of a condition which requires that the engine be shut down (i.e., low water level, low oil pressure or high water temperature). If the engine shutdown feature is enabled, the operator has about 15 seconds after the light goes on to pull to the side of the road before the engine shuts off. If the engine shutdown feature is disabled, the indicator will function as a warning light but the engine will not shut down.
- **Optional Tell-Tales**
- **Aftertreatment DEF tank Low Level Indicator (DEF)** — Illuminates when the fluid level is low. It also Flashes when the level becomes critically low.
- **Reverse Indicator** — Indicates that the transmission is in Reverse.
- **Optional Tell-Tales**
- **Low Air Pressure Warning Indicator** — Indicates low air pressure in the air brake system(s). This feature may also come with a buzzer.
- **Parking Brake Indicator** — Indicates that the parking brake is engaged.

## 56 INSTRUMENTS AND CONTROLS

---

- **Optional Tell-Tales**

- **HEST Indicator (Amber)** — The High Exhaust Temperature (HEST) indicator is displayed when the exhaust temperature reaches 300°C (572°F) and the regeneration process begins. When the regeneration process is completed, the engine should be allowed to run until the HEST indicator shuts off.

During regeneration while the vehicle is moving, the HEST indicator will only illuminate when vehicle speed is less than 8 kph (5 mph).

During a parked regeneration, the HEST indicator will turn off when regeneration is complete and the exhaust temperature has returned to a normal temperature.



C0029146

### HEST Indicator

- **Neutral Indicator** — Indicates that the transmission is in Neutral.

- **Optional Tell-Tales**

- **Anti-Lock Brake System (ABS) Indicator (Amber)** — Indicates an ABS malfunction. Also illuminates momentarily as a bulb check when the ignition is turned on. If the light turns on and stays on, a malfunction is indicated. If the light does not turn on when the ignition is turned on, the bulb and the power source may be defective. For additional information on operating an ABS-equipped vehicle, refer to “Anti-Lock Brake System (ABS)”, page 127, in the *OPERATION* section.

**Note:** When an ABS malfunction is detected, anti-lock braking in the affected wheel will be disabled and normal braking will return; the other wheels will retain anti-lock braking.

- **Automatic Traction Control (ATC) Indicator** — Indicates that ATC is operating.

- **Optional Tell-Tales**

- **Aftertreatment DPF Regeneration Required Icon** — Flashes when the Diesel Particulate Filter is full or overfull and regeneration is needed. The icon flashes when the filter is

- **Check Transmission Warning Indicator (If Equipped)** — Only present on vehicles equipped with automatic transmission.

- **Optional Tell-Tales**

- **Right-Hand Operation Indicator** — Indicates that a right-hand drive mode has been enabled.
- **Maintenance Due Indicator** — Indicates that a maintenance alert has been issued (maintenance is due).
- **Optional Tell-Tales**
- **Aftertreatment DPF Regeneration Inhibit Icon** — Illuminates when the inhibit switch is turned on. It will allow the driver to know that the switch is in a inhibit position and a regeneration will not occur.
- **Forced Neutral Indicator** — Illuminates when PTO is engaged and the truck is not moving.
- **Fuel Filter Restriction (If Equipped)**
- **Air Filter Restriction (If Equipped)**
- **Predictive Oil Change (If Equipped)**
- **Engine Oil Level Indicator** — If illuminated, immediately check the level of your engine oil.
- **Water in Fuel Indicator (If Equipped)** — Illuminates when water accumulates in the primary fuel filter sediment bowl. Stop the engine and drain the fuel from the sediment bowl.

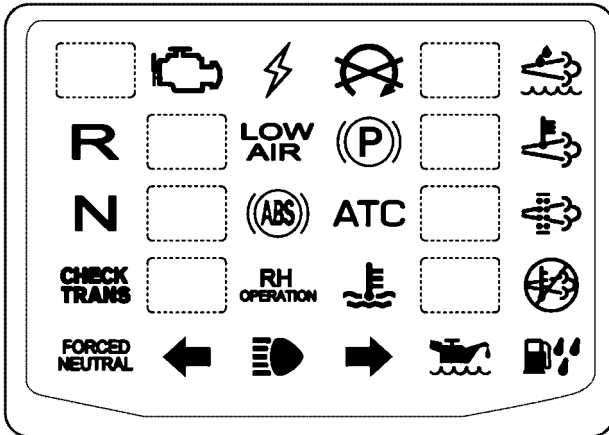

W3056183

**Detail of Warning/Indicator Light Panel – RH**

- **Optional Tell-Tales**



## 58 INSTRUMENTS AND CONTROLS

---

- **Malfunction Indicator lamp (MIL )**— MIL indicates government Regulation On Board Diagnostics (OBD) faults. Lamp remains active after repair until system operation confirms repair.
- **Electronic Malfunction Indicator (Amber)** — Illuminates when V-MAC® detects an electronic malfunction. Refer to the appropriate V-MAC® Operator's Guide for details.
- **Engine Shutdown Indicator (Red)** — Indicates the occurrence of a condition which requires that the engine be shut down (i.e., low water level, low oil pressure or high water temperature). If the engine shutdown feature is enabled, the operator has about 15 seconds after the light goes on to pull to the side of the road before the engine shuts off. If the engine shutdown feature is disabled, the indicator will function as a warning light but the engine will not shut down.
- **Optional Tell-Tales**
- **Aftertreatment DEF tank Low Level Indicator (DEF)** — Illuminates when the fluid level is low. It also Flashes when the level becomes critically low.
- **Reverse Indicator** — Indicates that the transmission is in Reverse.
- **Optional Tell-Tales**
- **Low Air Pressure Warning Indicator** — Indicates low air pressure in the air brake system(s). This feature may also come with a buzzer.
- **Parking Brake Indicator** — Indicates that the parking brake is engaged.
- **Optional Tell-Tales**
- **HEST Indicator (Amber) (If Equipped)** — The High Exhaust Temperature (HEST) indicator is displayed when the exhaust temperature reaches 300°C (572°F) and the regeneration process begins. When the regeneration process is completed, the engine should be allowed to run until the HEST indicator shuts off.
- **Neutral Indicator** — Indicates that the transmission is in Neutral.
- **Optional Tell-Tales**
- **Anti-Lock Brake System (ABS) Indicator (Amber)** — Indicates an ABS malfunction. Also illuminates momentarily as a bulb check when the ignition is turned on. If the light turns on and stays on, a malfunction is indicated. If the light does not turn on when the ignition is turned on, the bulb and the power source may be defective. For additional information on operating an ABS-equipped vehicle, refer to “Anti-Lock Brake System (ABS)”, page 127, in the *OPERATION* section.
- **Automatic Traction Control (ATC) Indicator** — Indicates that ATC is operating.
- **Optional Tell-Tales**

- **Aftertreatment DPF Regeneration Required Icon** — Illuminates when the Diesel Particulate Filter is becoming full and regeneration is needed. The icon flashes when the filter is full or overfull.
- **Check Transmission Warning Indicator (If Equipped)** — Only present on vehicles equipped with automatic transmission.
- **Optional Tell-Tales**
  - **Right-Hand Operation Indicator** — Indicates that a right-hand drive mode has been enabled.
  - **Coolant Temperature Gauge** — Indicates the temperature of the engine coolant. The normal operating temperature for Mack engines is between 77°C and 107°C (170°F and 225°F). The driver will receive a warning if coolant temperature reaches 223°F and engine shutdown will occur at 227°F if the engine coolant temperature shutdown option is enabled.
- **Optional Tell-Tales**
  - **Aftertreatment DPF Regeneration Inhibit Icon** — Illuminates when the inhibit switch is turned on. It will allow the driver to know that the switch is in a inhibit position and a regeneration will not occur.
  - **Forced Neutral Indicator** — Illuminates when PTO is engaged and the truck is not moving.
- Turn Signal Indicator LH** — Flash green when the turn signals are activated.
- High Beam Indicator (Blue)** — Indicates that high beams are on.
- Turn Signal Indicator RH** — Flash green when the turn signals are activated.
- **Engine Oil Level Indicator** — If illuminated, immediately check the level of your engine oil.
- **Water in Fuel Indicator (If Equipped)** — Illuminates when water accumulates in the primary fuel filter sediment bowl. Stop the engine and drain the fuel from the sediment bowl.
- 5. Speedometer/Odometer** — Indicates road speed in miles and/or kilometers per hour and total distance vehicle has traveled.
- 6. High Beam Indicator (Blue)** — Indicates that high beams are on.
- 7. Turn Signal Indicators** — Flash green when the turn signals are activated.
- 8. Fuel /DEF Gauge** — Registers the fuel and DEF levels in the supply tank(s).

## 60 INSTRUMENTS AND CONTROLS

---

**9. Air Pressure Gauge** — Indicates the air pressure in the air brake system(s). The normal operating air pressure is between 759 kPa (110 psi) and 897 kPa (130 psi) in both air brake systems. If pressure drops below 75 psi ( $\pm 5$  psi) in either system, the warning buzzer and warning light will go on. Determine the cause of failure before proceeding. Primary air pressure is supplied to the rear brakes and is indicated by the green pointer on the gauge. Secondary air pressure is supplied to the steering axle brakes and indicated by the orange pointer.

**10. Parking Brake Valve** — Yellow diamond-shaped knob. Pull to apply. Push to release. Applies parking brakes.

**11. Transmission Oil Temperature Gauge** — Indicates the temperature of the automatic transmission oil. The normal operating range is between 71°C and 93°C (160°F and 200°F). If the transmission oil temperature reaches 121°C (250°F), operation in the higher gears will be inhibited. If the transmission overheats during normal operation, stop the vehicle and check the transmission oil level. If both the transmission oil temperature gauge and the engine coolant temperature gauge indicate a high temperature, check the cooling system. If the cooling system appears to be functioning properly, shift the transmission into Neutral, set the parking brakes, and run the engine between 1200 and 1500 rpm. The engine and transmission should cool sufficiently within two to three minutes. If the temperature does not drop to operating range, the condition must be investigated and corrected before continuing operation.

**12. Voltmeter** — Indicates the surface charge of the battery with the engine NOT running (and the ignition ON). Indicates the condition of charging system with the engine running.

The voltmeter can be useful as a diagnostic tool. During cranking, the reading should not drop below 10 volts. Lower readings may indicate corroded connections at the cranking motor or battery terminals, or discharged or defective batteries.

**13. Mode Button** — Using this button will display diagnostic trouble code information and trip distance in the odometer. When you press and hold down this button, the display will go through a gauge self test. After the self test is complete, diagnostic trouble code information will be displayed, by MID, in the speedometer/odometer screen. When the first MID is displayed, push the Mode button again to display the 1st diagnostic trouble code for this MID. At the end of the diagnostic trouble code list for each MID, "CLEAR" will be displayed. You have the option here to clear the codes for this MID. If you choose to do so, press and hold the Mode button. Once the codes are cleared for this MID, the next MID will be displayed.

By pressing this button once (NOT holding it down), information for Trip 1 distance will be displayed. Press and hold the Mode button to clear Trip 1 information.

By pressing this button twice, information for Trip 2 distance will be displayed. Press and hold the Mode button to clear Trip 2 information.

**14. Hour Meter** — Indicates hours of engine operation. Hours of operation should be used as a guide for certain engine or PTO maintenance operations.

**15. CB Radio Auxiliary Hookup**

**16. DPF Smart Switch (If Equipped)** — This is a three-position switch where the middle position is neutral.

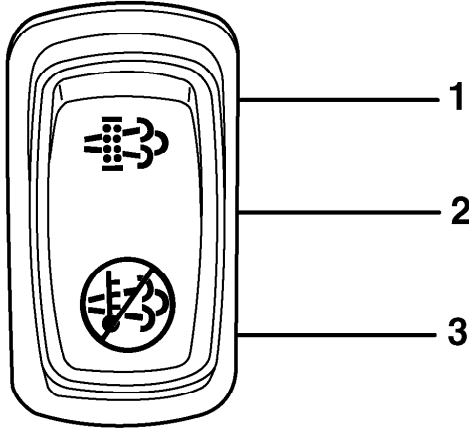

C0029592

1. Upper Position — Regeneration Position

2. Middle Position — Neutral Position

3. Down Position — Inhibit Position

## 62 INSTRUMENTS AND CONTROLS

---

### DPF INHIBIT ROAD SPEED LIMITING (RSL)

The DPF Smart Switch can be locked into the DOWN (or Inhibit Regen) position by the driver. If the DPF Smart Switch remains in the locked position, the following vehicle speed limiting will occur:

- 1 Vehicle Moving. If vehicle is moving with the DPF Smart Switch in the locked (DOWN) position, the vehicle speed will decrease down to 16 kph (10 mph) below the current speed until the driver releases the switch back to the neutral (MIDDLE) position.
- 2 Vehicle Stationary and then Moving. If the vehicle is stationary with the DPF Smart Switch in the locked (DOWN) position and the driver then begins to move the truck, the vehicle speed will be limited to 16 kph (10 mph) until the driver releases the switch back to the neutral (MIDDLE) position.

**17. Inter-Axle Power Divider Lockout Switch (If Equipped) —** See Inter-Axle Power Divider Lockout in the *OPERATION* section of this handbook on .

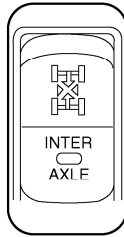

C0029594

**18. Telma Rear Axle Mounted Retarder Indicator Lamp (If Equipped) —** The Telma does not have a disable switch. It is always on and will operate at different levels depending on application of service brake. The indicator will show you the level you are retarding the vehicle: 20%, 40%, 60%, 80% or 100%.

**Note:** The Telma retarder is disabled if there is an ABS event.

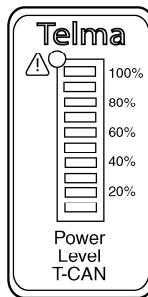

C0029217

**Telma Retarder**

## 64 INSTRUMENTS AND CONTROLS

**19. Windshield Wiper/Washer Controls** — Depress the ON/OFF button to turn the windshield wipers on or off. Pull the button up to make the wipers faster, push the button down to make the wipers slower. Depress the "WASH" button to activate the washer fluid.

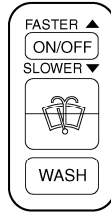

C0029595

**20. Automatic Traction Control Switch/Heavy Mud/Snow** — Activate for increased traction control in heavy mud or snow. (See "Automatic Traction Control (ATC) (If Equipped)", page 130 in the *OPERATION* section of this manual for more details.) When the operator presses the top of the rocker switch, the heavy mud/snow function ATC indicator lamp blinks continuously. The ATC lamp stops blinking when the ATC mode switch is pressed again or ignition key cycled.



### CAUTION

*Be sure to deactivate the heavy mud/snow function when no longer needed. Continued operation with the heavy mud/snow function active will result in vehicle damage. If after a reasonable amount of time (no more than five minutes) the vehicle is still not moving, deactivate the ATC and put on chains.*

**21. Cab Climate Control Panel** — See the CAB CLIMATE CONTROL section for more information.

**22. Power Take-Off Control Switch (If Equipped)** — Push the top in to turn the PTO on. Push the bottom in to turn it off.

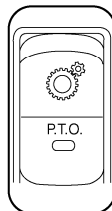

C0029596

**23. Auxiliary Switch** — As defined by the Body Builder.

**24. Parking Brake Valve** — Pull to apply. Push to release. Applies tractor parking brakes and trailer brakes, if equipped.

**25. Auxiliary Switch** — As defined by the Body Builder.

**26. Light Control Panel** — See the LIGHT CONTROL PANEL section for more information.

**27. Combination Starter and Electrical Switch** — Starts the engine and activates the accessory relay. To start the engine, turn key clockwise. To activate the accessories, turn the key counterclockwise. When the switch is turned ON (in either direction), a warning buzzer will sound if air pressure is below  $448\pm34$  kPa ( $65\pm5$  psi); the buzzer will turn off as soon as sufficient air pressure is restored. When the key is straight up and down, the switch is OFF.

**28. Right-Hand Operation Switch** — Allows the operator to switch to a right-hand drive mode. To use:

**Note:** Speed is restricted to 2nd gear when operating the vehicle from the right-hand side.

- Stop the vehicle.
- Put the transmission in NEUTRAL.
- Set the parking brake.
- Go to the right side of the vehicle.
- Flip the switch to the right.

## 29. Moto-Mirror Switch (If Equipped)

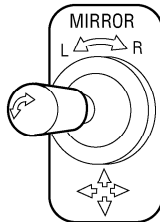



## 66 INSTRUMENTS AND CONTROLS

---

**30. Heated Mirror Switch (If Equipped)** — Activates the outside heated mirrors (for use in icy conditions).

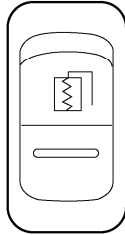

C0029598

**31. Resume/Set Switch** — This is a V-MAC® switch; for more information, refer to the applicable V-MAC® Operator's Guide.

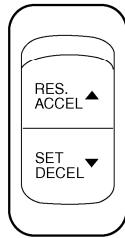

C0029150

**32. Speed Control Switch** — This is a V-MAC® switch; for more information, refer to the applicable V-MAC® Operator's Guide.

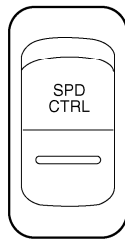

C0029211

**33. Cigar Lighter** — Press in the lighter; it will pop out when element is hot.



### CAUTION

*Maximum amperage for the in-dash cigar lighter is 10 amps. Do NOT use the cigar lighter receptacle to power accessories rated higher than 10 amps.*

or

**Accessory Power Outlet** — See instructions under Accessory Power Outlets listed in the Instrument and Controls Section of this manual.

**34. Air Pressure Gauge** — Indicates the air pressure in the air brake system(s). The normal operating air pressure is between 759 kPa (110 psi) and 897 kPa (130 psi) in both air brake systems. If pressure drops below 75 psi ( $\pm 5$  psi) in either system, the warning buzzer and warning light will go on. Determine the cause of failure before proceeding. Primary air pressure is supplied to the rear brakes and is indicated by the green pointer on the gauge. Secondary air pressure is supplied to the steering axle brakes and indicated by the orange pointer.

**35. Speedometer/Odometer** — Indicates road speed in miles and/or kilometers per hour and total distance vehicle has traveled.

# 68 INSTRUMENTS AND CONTROLS

## CAB CLIMATE CONTROL

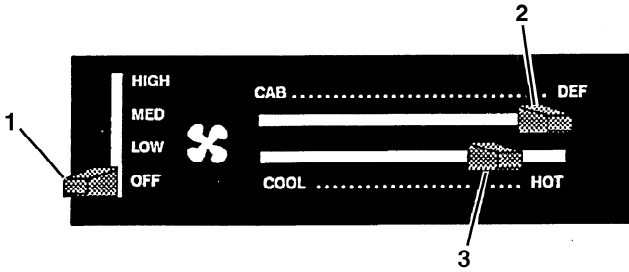

C0029599

1. Fan Control Switch

2. Mode Selection Lever

3. Temperature Control Lever

**1. Fan Control Switch** — Controls the amount of air delivered through the vents. Down is OFF and up is HIGH speed. The middle positions are LOW and MEDIUM speeds.

**2. Mode Selection Lever** — Allows the operator to choose the air direction. The CAB position delivers air to the floor outlets, while the DEF position directs air to the windshield for defogging and/or defrosting. Sliding the lever in between positions provides a blend of the two.

**3. Temperature Control Lever** — Controls the temperature of air from COOL (far left) to HOT (far right).

## LIGHT CONTROL PANEL

This panel controls the parking lights, interior panel lights, headlights and fog lights (if equipped).

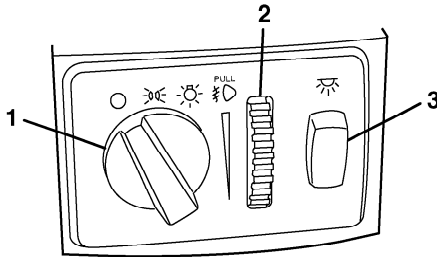

C0029600

1. Light Control Knob/Pull for Fog	3. Hook-Up Lamps or Perimeter Lighting (If Equipped)
2. Panel Dimmer Switch	

With the light control knob in the left position, all lights are off. With the knob in the middle position, the parking lights and interior panel lights will illuminate. With the knob in the far right position, the headlights will turn on.

To turn on the fog lights (if equipped), put the knob in the far right position and pull out the fog light button (see Figure above). The fog light symbol will illuminate indicating the lights are on.

To adjust the intensity of the panel light, move the panel dimmer switch back and forth.

To turn on the hook-up lamps or perimeter lighting (if equipped), push the right switch up.

# 70 INSTRUMENTS AND CONTROLS

## STEERING COLUMN

### Combination Starter and Electrical Switch

#### Turn Signal Lever

**Note:** The turn signals are not self-cancelling and must be returned to the middle position manually.

The turn signal lever is located on the steering column. It performs a number of functions, including activating the high and low beams and the hazard switch (see illustration on following page).

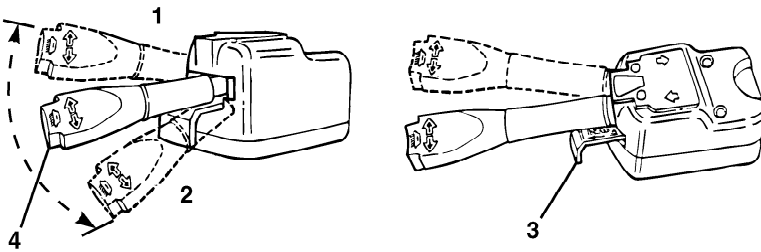

C0029601

1. Handle in Right Turn Position and Cancel Position of Hazard Warning

2. Handle in Left Turn Position and Cancel Position of Hazard Warning

3. Pull for Warning Hazard Position

4. Push Button for Hi/Lo Beam

## MISCELLANEOUS CONTROLS

### Dome Light

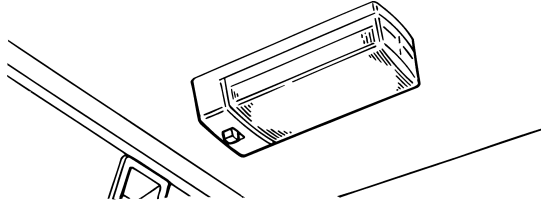

C0029602

Push the switch to the right to turn the dome light on. Push the switch to the left to turn the dome light off.

### Air Horn

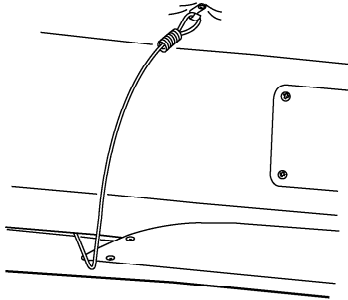

C0029603

The air horn(s), if equipped, is activated by pulling down on the cord that is located above the driver near the overhead console.

## 72 INSTRUMENTS AND CONTROLS

### Fresh Air Vent

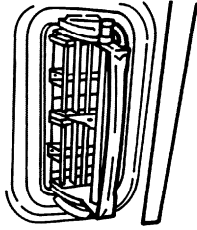

C0029604

An air vent, located in the driver side door, is provided to circulate outside air to the cab interior. Move the vent lever forward or rearward to open the vent. Move the lever to the center to close the vent.

### Accessory Power Outlets

Additional 12-volt accessory power outlets are located next to the driver on the "E" panel. These cigar light-type outlets supply 12 volts of fused (20A) power when the ignition switch is turned to the ignition or accessory position.

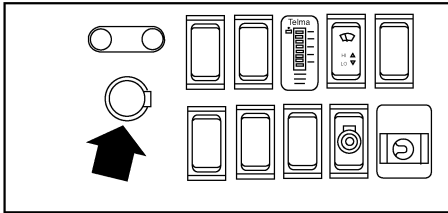

C0029605



#### CAUTION

*Maximum amperage for all power receptacles in cab is 20 amps. Do NOT exceed maximum amperage as equipment damage may result.*

## **PRE-TRIP**



### **DANGER**

*Before working on or inspecting a vehicle, set the parking brakes, place the transmission in neutral and block the wheels. Failure to do so can result in unexpected vehicle movement and can cause serious personal injury or death.*

Safety is the most important and obvious reason for doing a pre-trip inspection. Federal and state laws require inspection performed by the driver. Federal and state inspectors also inspect commercial vehicles. An unsafe vehicle can be placed "out of service" until the driver or owner corrects the deficiency. Owners and operators should familiarize themselves with sections 49 CFR 396.11 and 396.13 concerning Federal requirements for vehicle inspection. Certain other laws may also apply.

Section 49 CFR 396.13 states that all motor carrier drivers must complete a written report at the end of each work day for each vehicle operated, covering most of what is covered in the pre-trip list. The report should list all defects or deficiencies discovered by the driver. A pre-trip inspection prepares for the end-of-work report.

Starting on the next page are suggested guidelines to be used in performing truck, tractor and trailer pre-trip inspections. Depending on the application of the vehicle being used, these guidelines should be modified to include other necessary inspection points. For example, steps and grab handles should be checked daily on refuse trucks because the operator is getting in and out of the cab more frequently.

If any component or system does not pass this inspection, it must be corrected before operating the vehicle. Whenever equipment requires adjustment, replacement, repair or lubrication, refer to the Service Manuals or contact an authorized Mack Truck dealer for the correct procedures, specifications and intervals.

Take your time going through the pre-trip inspection. Remember that a careful pre-trip inspection saves time by eliminating unscheduled stops for correcting a faulty item.

The following information has been provided by the American Trucking Association as developed by the D.O.T. Office of Motor Carriers (BMCS).

## **Pre-Trip Inspection Quick List**

Inspect the vehicle in a circular manner.

### ***Approaching the Vehicle***



## 74 PRE-TRIP INSPECTION AND DAILY MAINTENANCE

---

- Check under the vehicle for oil, fuel, coolant leaks or other signs of damage.
- Check body surfaces for signs of breaks or damage.

### ***Preparation***

- Open drain cocks on air tanks to let the tanks drain.
- Chock wheels on vehicle and, if hooked up, trailer.
- Close air tank drain cocks.
- Start the engine and let the air pressure build up to normal. Stop engine check for air leaks.
- Switch on parking lights and hazard lights.
- Apply parking brakes. Listen for air leaks
- Raise cab so belts can be checked

### ***Step 1: Left Side of the Cab***

#### **Left Front Wheel**

- Check condition of wheel rim. Especially look for cracks, missing lockrings, bent or broken studs, missing clamps or lug nuts.
- Check condition of tire: properly inflated, no serious cuts, bulges, tread wear or any signs of misalignment; valve stem not touching wheel, rim or brake drum; valve cap in place.
- Check wheel bearing and hub: no obvious leaking on outside or inside wheel. Verify correct oil level in hub.

#### **Left Front Suspension**

- Check condition of spring, spring hangers, shackles, U-bolts: no cracks, breaks or shifting.
- Check shock absorber condition.

#### **Left Front Brake**

- Condition of brake drum. With brakes released, look for a noticeable gap between lining and drum. (This check cannot be made if dust covers are in place.)
- Condition of brake air hose.
- Check brake chamber mounting bolts and bracket.

- Check slack adjuster and chamber pushrod travel for proper brake adjustment.

## **Condition of Front Axle and Steering System, Left Side**

- No loose, worn, bent, damaged or missing parts.

## **Engine Compartment, Left Side**

- Check coolant hose condition.
- Check condition of fan drive belts.
- Check engine and surrounding areas for coolant, oil and fuel leaks.
- Check wiring harnesses for signs of damage.

## **Engine Compartment, Right Side**

- Check condition of coolant and heater hoses.
- Check condition of fan drive belts.
- Check engine and surrounding areas for coolant, oil and fuel leaks.
- Check fuel separator sight glass and drain if necessary. Check for leaks.
- Check wiring harnesses for signs of damage.
- Check air filter with brackets and hoses for loose connections or damage. Check filter gauge, if mounted on the filter.

## **Step 2: Front of Cab Area**

### **Condition of Windshield**

- Check for damage and clean if dirty.
- Check windshield wiper arms for proper spring tension.
- Check wiper blades for any damage, "dead" rubber and attachment to arm.

### **Lights and Reflectors**

- Lower cab and inspect parking, clearance and identification lights on cab. They should be clean, operating and of the proper color.
- Reflectors clean and proper color.
- Turn on headlights. High and low beams should be operating and lenses clean. If equipped, check daytime running lights.

# 76 PRE-TRIP INSPECTION AND DAILY MAINTENANCE

---

- Left and right front turn signal lights clean, operating and proper color.

## **Grille**

- Check that charge air cooler and radiator or bugscreens are clean and undamaged.

## ***Step 3: Right Side of Cab Area***

### **Right Front Wheel**

- Check condition of wheel rim. Especially look for cracks, missing lockrings, bent or broken studs, missing clamps or lug nuts.
- Check condition of tire: properly inflated, no serious cuts, bulges, tread wear or any signs of misalignment; valve stem not touching wheel, rim or brake drum; valve cap in place.
- Check wheel bearing and hub: no obvious leaking on outside or inside wheel. Verify correct oil level in hub.

### **Right Front Suspension**

- Check condition of spring, spring hangers, shackles, U-bolts: no cracks, breaks or shifting.
- Shock absorber condition.

### **Right Front Brake**

- Condition of brake drum. With brakes released, look for a noticeable gap between lining and drum. (This check cannot be made if dust covers are in place.)
- Condition of brake air hose: check for any chafing.
- Check brake chamber mounting bolts and bracket.
- Check slack adjuster and chamber pushrod travel. With brakes applied or released, look for conspicuously different positions of the slack adjusters for proper brake adjustment.

### **Condition of Front Axle and Steering System, Right Side**

- No loose, worn, bent, damaged or missing parts.

## ***Step 4: Right Saddle Tank Area***

## **Right Fuel Tank(s)**

- Securely mounted Diesel and Diesel Exhaust Fluid are not damaged or leaking.
- Fuel lines secure and not leaking. Check that shut-off valves are open.
- Tank(s) full of fuel. Cap on and secure.

## **Condition of Visible Components**

- Rear of engine: not leaking.
  - Transmission: not leaking. If equipped with oil cooler, check cooler, hoses and fittings for leaks.
  - Check drive shaft.
  - Exhaust system: secure, not leaking, not touching wires, fuel or air tubing.
  - Frame and cross members: no bends, cracks or breaks.
- DPF/SCR check hoses and fittings for leaks.
- Air tubing and electrical wiring: secured against snagging and chafing.

## **Step 5: Right Rear Vehicle Area**

### **Dual Wheels, One or Two Axles**

- Check condition of wheels and rims. Especially look for cracks, missing lockrings, bent or broken spacers, studs, missing clamps or lug nuts.
- Check condition of tires: properly inflated, no serious cuts, bulges, tread wear or any signs of misalignment; valve stems not touching wheels, rims or brake drums; valve caps in place and no objects stuck between the wheels.
- Check that both tires are of same type, for example, not mixed radial and bias type and that their circumferences are matched.
- Check wheel bearing and hub: no obvious leaking on outside or inside wheel.

### **Suspension**

- Check condition of springs (leaf), spring hangers, shackles and U-bolts.
- Axle alignment.

### **Brakes**

- Condition of brake drums. With brakes released, look for a noticeable gap between lining and drum. (This check cannot be made if dust covers are in place.)

# 78 PRE-TRIP INSPECTION AND DAILY MAINTENANCE

---

- Condition of brake hoses: check for any chafing.
- Check brake chamber mounting bolts and brackets.
- Check slack adjusters and chamber push rod travel. With brakes applied or released, look for conspicuously different positions of the slack adjusters for proper adjustment.
- Check spring brakes.

## ***Step 6: Rear of Vehicle Area***

### **Frame Area**

- Frame or cross members not bent, cracked or otherwise damaged or missing.
- Check that air tubing and electrical lines are properly secured to the frame with no damage or chafing.

### **Lights and Reflectors**

- Tail lights, brake lights and turn signal lights: operating, clean and proper color.

## ***Step 7: Coupling System Area***

### **Fifth Wheel**

- Securely mounted to the frame.
- No missing or damaged parts.
- Check that trunnion and plate are properly lubricated.

### **Sliding Fifth Wheel**

- Mechanism not worn, bent, damaged or parts missing.
- Properly lubricated.
- All locking pins present and locked in place.
- If air operated: no air leaks.

### **Air Tubing and Electric Lines Visible From This Point**

- Should be secure from dangling.
- Both air lines and electric line should be free from damage, oil and grease.

## **Step 8: Left Saddle Tank and Left Rear Vehicle Wheels Area**

### **Dual Wheels, One or Two Axles**

- Check condition of wheels and rims. Especially look for cracks, missing lockrings, bent or broken spacers, studs, missing clamps or lug nuts.
- Check condition of tires: properly inflated, no serious cuts, bulges, tread wear or any signs of misalignment; valve stems not touching wheels, rims or brake drums; valve caps in place and no objects stuck between the wheels.
- Check that both tires are of same type, for example, not mixed radial and bias type and that their circumferences are matched.
- Check wheel bearing and hub: no obvious leaking on outside or inside wheel.

### **Suspension**

- Check condition of springs (leaf or air), spring hangers, shackles and U-bolts, no cracks, breaks or shifting.

### **Brakes**

- Condition of brake drums. With brakes released, look for a noticeable gap between lining and drum. (This check cannot be made if dust covers are in place.)
- Condition of brake hoses: check for any chafing.
- Check brake chamber mounting bolts and brackets.
- Check slack adjusters and chamber push rod travel. With brakes applied or released, look for conspicuously different positions of the slack adjusters for proper brake adjustment..
- Check spring brakes.

### **Condition of Visible Components**

- Transmission: not leaking.
- Drive shaft: looks OK.
- Exhaust system: secure, not leaking, not touching wires, fuel or air tubing.
- Frame and cross members: no bends, cracks or breaks.
- Air tubing and electrical wiring: secured against snagging and chafing.

### **Left Fuel Tank(s)**

- Securely mounted and not damaged or leaking.

## 80 PRE-TRIP INSPECTION AND DAILY MAINTENANCE

---

- Fuel lines secure and not leaking. Check that shut-off valves are open.
- Tank(s) full of fuel. Cap on and secure.

### **Battery Area**

- Open the battery box. Battery box securely mounted to vehicle.
- Batteries secured against movement.
- Battery cases not broken or leaking. Battery cables free from damage.
- Tops of batteries and terminals clean and free from foreign material.
- If equipped, replace battery lid and make sure it is securely fastened.

### ***In the Cab***

- Check steps and grab handles for looseness or breakage. Also, clean them if there is any substance that makes them slippery, which makes cab entry/exit hazardous.
- Start the engine. If equipped, check that exhaust rain cap opens when accelerating engine.
- Check gauges and tell-tale light function. See the Instruments and Controls section.
- Check function of low air warning.
- Check clutch function. If equipped, check for clutch brake function.
- Check windshield wipers and washers and horns, including back-up alarm, if equipped.
- Clean inside windshield, door windows and instruments. Clean mirrors.
- Check temperature control and defroster. If equipped, check mirror heater.
- Check condition of warning triangles, fire extinguisher and flares.
- Adjust the seat. Check mirror adjustment.
- Check safety belts for function and damage.
- Apply service brakes. After initial drop, pressure should hold steady, or increase slightly, with engine at idle.
- Check steering wheel for excessive free play.
- Check for loose items in the cab. Secure them if necessary.

### ***Hooking Up To Trailer***

## **Hook-Up Preparation**

- Check kingpin and mounting plate on trailer, free from wear, bends or damage.
- Chock trailer wheels.

## **Fifth Wheel or Trailer Hitch**

- No visible space between fifth wheel and trailer.
- Locking jaws around the shank and not the head of kingpin.
- Release lever properly seated and safety latch/lock engaged.
- Check all connections to dolly or trailer hitch and safety chains are secured.
- Check function of trailer air supply valve and trailer brakes.

## **Sliding Fifth Wheel**

- Check that fifth wheel is not so far forward that the tractor frame will strike the landing gear during turns.

**Note:** Refer to the trailer manufacturer's manual for specific information on the trailer checks.

## ***Step 9: Trailer Front Area***

### **Air and Electrical Connections**

- Glad hands properly mounted, free from damage and not leaking.
- Trailer cord receptacle properly mounted, free of damage; plug properly seated and safety catch engaged to prevent accidental disconnect.
- Air and electrical lines properly secured against tangling, snagging and chafing with sufficient slack for turns.

## ***Step 10: Right Side of Trailer Area***

### **Landing Gear or Dolly Area**

- Fully raised; no missing or damaged parts.
- Crank handle present and secured.
- If power operated, no air/hydraulic leaks.

## **Spare Wheel(s)**



## 82 PRE-TRIP INSPECTION AND DAILY MAINTENANCE

---

- Carrier or rack not damaged.
- Spare wheel securely mounted in rack.
- Tire and wheel condition adequate for a spare: proper size, properly inflated.

### **Lights and Reflectors**

- Trailer side clearance lights: clean, operating and proper color.
- Reflectors clean and proper color.

### **Frame and Body**

- Frame and crossmembers not bent, cracked, damaged or missing.
- Proper placarding.
- Body parts not damaged or missing.

### ***Step 11: Right Rear Trailer Wheel***

#### **Dual Wheels, One or Two Axles**

- Check condition of wheels and rims. Especially look for cracks, missing lockrings, bent or broken spacers, studs, missing clamps or lug nuts.
- Check condition of tires: properly inflated, no serious cuts, bulges, tread wear or any signs of misalignment; valve stems not touching wheels, rims or brake drums; valve caps in place and no objects stuck between the wheels.
- Check that both tires are of same type, for example, not mixed radial and bias type and that their circumferences are matched.
- Check wheel bearing and hub: no obvious leaking on outside or inside wheel.

### **Suspension**

- Condition of springs (leaf or air), spring hangers, shackles and U-bolts.
- Axle alignment.
- Condition of torque rod arms.
- If equipped with sliding axles, check position and alignment. Look for damaged, worn or missing parts, all locks present, fully in place and locked.
- Flexible air tubing not cracked, cut, crimped or otherwise damaged. Secured against tangling, dragging and chafing.

### **Brakes**

- Condition of brake drums. With brakes released, look for a noticeable gap between lining and drum. (This check cannot be made if dust covers are in place.)
- Condition of brake hoses: check for any chafing.
- Check brake chamber mounting bolts and brackets.
- Check slack adjusters and chamber push rod travel. With brakes applied or released, look for conspicuously different positions of the slack adjusters for proper brake adjustment..
- Check spring brakes.

## ***Step 12: Rear of Trailer Area***

### **Lights and Reflectors**

- Rear clearance, identification and tail lights clean, operating and proper color.
- Reflectors clean and proper color.

### **Cargo Securement**

- Cargo properly blocked, braced, tied, chained, etc.
- Tailboard up and properly secured. End gates free from damage, properly secured in stake pockets.
- Canvas or tarp (if required) properly latched down to prevent water damage, tearing, billowing or blockage of either mirrors or tail lights.
- Rear doors securely closed, latched or locked; required security seals in place.
- Underside guard in place: not cracked, bent or broken.

## ***Step 13: Left Rear Trailer Wheels Area***

### **Dual Wheels, One or Two Axles**

- Check condition of wheels and rims. Especially look for cracks, lockrings missing, bent or broken spacers, studs, missing clamps or lug nuts.
- Check condition of tires: properly inflated, no serious cuts, bulges, tread wear or any signs of misalignment; valve stems not touching wheels, rims or brake drums; valve caps in place and no objects stuck between the wheels.
- Check that both tires are of same type, for example, not mixed radial and bias type and that their circumferences are matched.
- Check wheel bearing and hub: no obvious leaking on outside or inside wheel.

# 84 PRE-TRIP INSPECTION AND DAILY MAINTENANCE

---

## **Suspension**

- Condition of springs (leaf or air), spring hangers, shackles and U-bolts.
- Axle alignment.
- Condition of torque rod arms.
- If equipped with sliding axles, check position and alignment. Look for damaged, worn or missing parts, all locks present, fully in place and locked.
- Flexible air tubing not cracked, cut, crimped or otherwise damaged. It should be secured against tangling, dragging and chafing.

## **Brakes**

- Condition of brake drums. With brakes released, look for a noticeable gap between lining and drum. (This check can not be made if dust covers are in place.)
- Condition of brake hoses: check for any chafing.
- Check brake chamber mounting bolts and brackets.
- Check slack adjusters and chamber push rod travel. With brakes applied or released, look for conspicuously different positions of the slack adjusters.
- Check spring brakes.

## ***Step 14: Left Side of Trailer Area***

### **Landing Gear or Dolly Area**

- Fully raised; no missing or damaged parts.
- Crank handle present and secured.
- If power operated, no air/hydraulic leaks.

### **Spare Wheel(s)**

- Spare wheel securely mounted in rack with no damage to rack.
- Tire and wheel condition adequate for a spare: proper size, properly inflated.

### **Lights and Reflectors**

- Trailer side clearance lights: clean, operating and proper color.
- Reflectors clean and proper color.

## **Frame and Body**

- Frame and crossmembers not bent, cracked, damaged or missing.
- Proper placarding.
- Body parts not damaged or missing.

## ***Before Leaving the Parking Area***

- Remove chocks from the wheels.
- Test trailer hook-up by slowly pulling while applying the trailer brakes with the trailer brake hand control valve.
- Test the service brakes before leaving the parking area.
- Test parking brakes by stopping on a 20% grade and applying the parking brakes. The parking brakes shall hold the combined vehicle and trailer without moving.

# 86 OPERATION

---

## New Vehicle Break-In

To ensure many years of reliable, trouble-free operation, the following break-in procedures are recommended:

**Note:** Oil change, filter change and chassis lubrication are no longer required at the 3,000-mile vehicle break-in interval.

Refer to the preventive maintenance schedules outlined in the *Maintenance and Lubrication Manual (21394653)* for recommended lubrication change intervals for the following items:

- Gear oils (transmission, rear axle carrier[s], front drive axle carrier, transfer case, flywheel PTO)
- Engine oil
- Oil filters
- Fuel filters
- Coolant conditioner

**Note:** It is important that components be filled with lubricants meeting the specifications as given in the *Maintenance and Lubrication Manual (21394653)*

**Note:** When checking oil levels, the vehicle must be parked on level ground, and the units at normal operating temperature. Components must be filled to the correct level. DO NOT OVERFILL.

**Note:** Oil and filter change intervals in this manual pertain to components built by Mack Trucks, Inc. For information concerning oil and oil filter change intervals for vendor components, refer to the specific vendor component service literature.

### ***During the First 5000 Kilometers (3000 Miles)***

- After the first 200 km (125 miles), retorque the wheel nuts using an accurately calibrated torque wrench. Recheck this torque again after 800 km (500 miles).
- Check oil and coolant levels frequently.
- Check brake and clutch adjustments per recommended maintenance schedule, and adjust as needed.
- Observe the instruments often, and shut down the engine at the first sign of any abnormal readings.
- Report all leaks, loose fasteners, unusual noises, etc., to the service representative at the nearest Mack dealership so they can be checked and corrected.

- Check the spring clip torque (U-bolts). (On REYCO suspensions, also check equalizer nut torque.)
- On chassis equipped with AIRTEK™ front axle air suspensions, retorque the U-bolts.
- Check the U-bolt torque on the MACK air suspension at the end of the first 1600 km (1000 miles).

### ***After the First 5000 Kilometers (3000 Miles) or Before 6400 Kilometers (4000 Miles) or Before 3 to 4 Months***

- Retorque the spring clip (U-bolts). (On REYCO suspensions, also retorque the equalizer nut.)

**Note:** On chassis equipped with AIRTEK™ front axle air suspensions, check the torque of the front axle U-bolts at 24 000 kilometers (15,000 miles).

### ***At the First A Inspection Interval***

- Check front and rear axle alignment and adjust if the alignment is out of specifications.
- Check steering knuckle to axle beam clearance.

Although this quality-built vehicle has been inspected, lubricated and adjusted at the MACK Trucks Assembly Plant, an occasional air, oil or coolant leak may develop. Quick action to correct these minor items will prevent a major repair later. Take the vehicle to the nearest MACK service center as soon as any abnormal condition becomes evident.

### ***Initial Valve Adjustment Intervals***

Refer to the *Maintenance and Lubrication Manual (21394653)* for detailed information concerning the Initial Valve Adjustment Interval also see page 223.

# 88 OPERATION

---

## WINDSHIELD WASHER RESERVOIR

As shown in the drawing below, the windshield washer reservoir is located on the driver-side back of the cab.

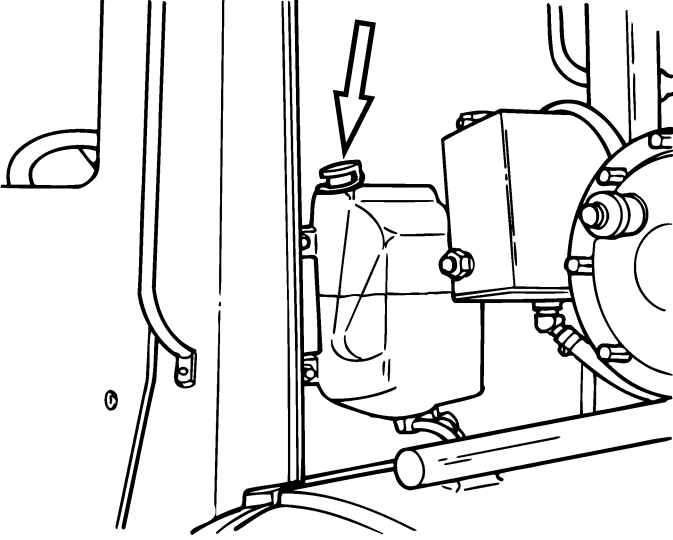

C0029606

---

## CAB TILT OPERATION



### DANGER

*Before attempting to tilt the cab, be certain to take the following steps:*

- *Park on a level surface.*
- *Apply the parking brake.*
- *Place the gearshift lever in NEUTRAL position.*
- *Shut off the engine.*
- *Secure all loose items within the cab.*
- *Close the cab doors.*

The cab is mounted on the chassis frame by two front hinges and two rear cab locks. This arrangement allows the cab to tilt forward to a maximum of 60 degrees, exposing the engine compartment for easy accessibility.

The cab tilt system uses one hydraulic cylinder. It incorporates internal safety valves which lock up automatically if the cab moves too rapidly in either direction.

The hydraulic fluid pressure imbalance forces the check valves to seat, holding the cab in a hydraulically locked position. If this situation occurs, operate the pump in the opposite direction to open the check valves. The system will then be returned to normal operation.



# 90 OPERATION

---

## Tilting the Cab

Use the following instructions to tilt the cab:

**Note:** Before raising the cab, the engine must be shut off and all loose items in the cab must be secured.

1. Take the cab tilt pump handle from its stored position.

**Note:** The cab tilt pump handle is stored inside the cab, on the right side cab back wall, behind the folding seat.

2. Insert the handle into the pump and move the pump control lever (see arrow) to the RAISE position (refer to the illustration).

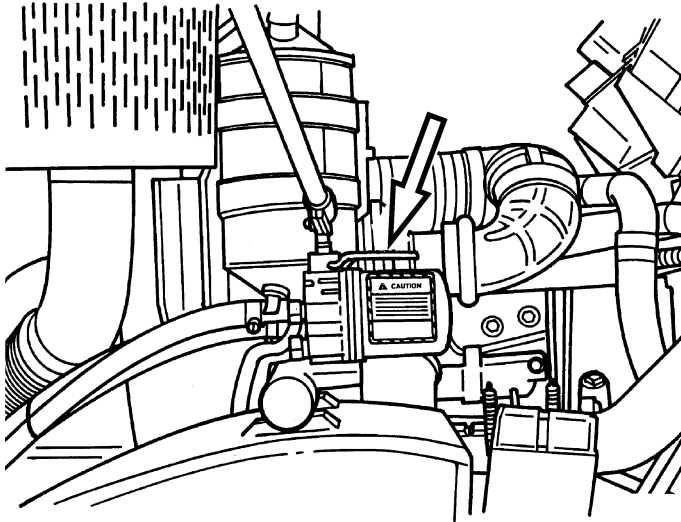

C0029607

**Pump Control Lever (Arrow)**

3. To raise to the service position, pump the cab up to the SERVICE HEIGHT position.

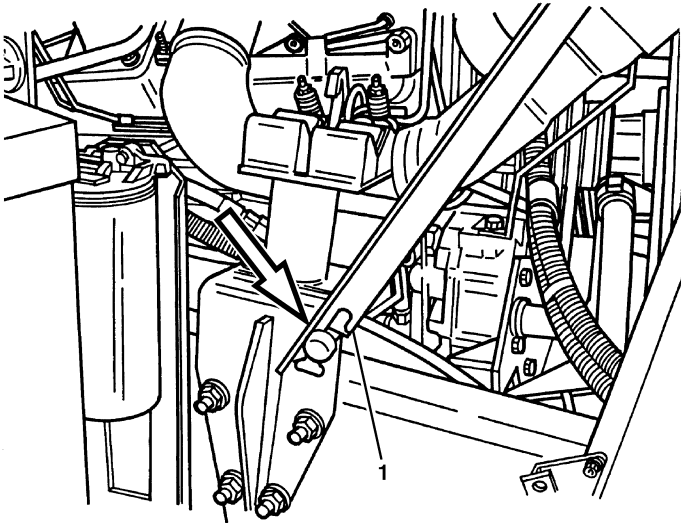

C0029616

## 1. Safety Prop

**Note:** In the service position, the cab must be secured with the safety prop (see illustration).

4. To secure the cab in the service position, loosen the thumbscrew and swing the safety prop down onto the safety prop stud (see arrow). The slot in the safety prop should settle securely around the stud (refer to the illustration above).



## WARNING

**Be certain that there are no people, tools or unsecured vehicle parts in the path of the descending cab before shifting the pump control lever.**

5. It may be necessary to manipulate the pump control lever, while the cab is descending, so the safety prop settles on the stud.

## 92 OPERATION

---

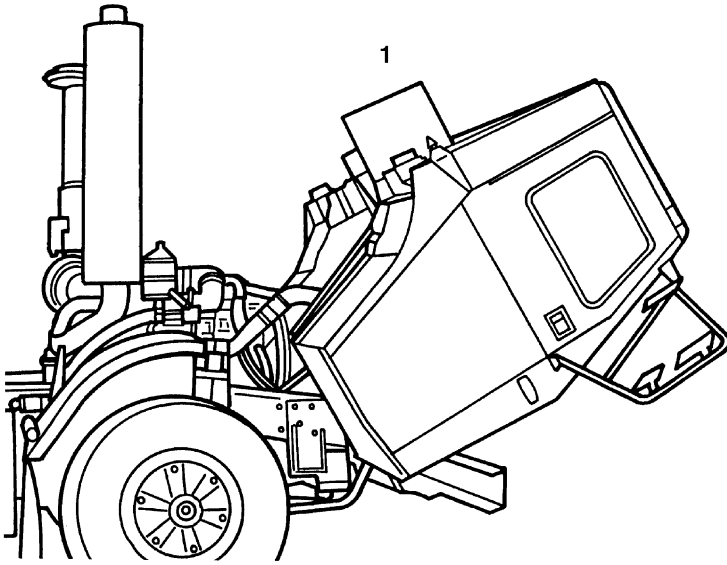

C0029617

### 1. Cab Full Tilt Position

6. To raise the cab to the full tilt position, pump the cab up past the balance point. Note that the cab will descend by itself, although the rate of descent may be controlled by manipulating the pump control lever from the RAISE to LOWER position.

## Lowering the Cab

**Note:** Before lowering the cab, the cab safety prop must be in the stored position and the transmission must be in NEUTRAL.

1. Move the pump control lever to the LOWER position.
2. Pump until the cab is past the balance point and allow the cab to descend and latch.
3. Leave the pump control lever in the LOWER position while the vehicle is in operation.

## Bleeding the Cab Tilt System

**Note:** In order to bleed the system, the cab must be in the lowered position.

**Note:** To perform a system bleed, the following steps must be performed in the designated order:

1. Connect all hydraulic lines.
2. Tighten all connections (except two) at the tilt cylinder.
3. Tighten one connection at each latch cylinder.
4. Fill the pump reservoir to the top with MACK specified oil.



### CAUTION

*Do not refill the reservoir with the cab in the RAISE position.*

5. Close and tighten the fill plug.
6. Shift the pump control lever to the LOWER position and pump until the LOWER lines are bled; also tighten the corresponding connections.
7. Shift the pump control lever to the RAISE position and pump until the RAISE lines are bled; also tighten the corresponding connections.
8. Bleed the latch cylinders and tighten the connections.
9. Bleed the push port of the tilt cylinder and tighten the connections.
10. After the entire system has been bled, shift the pump control lever to the LOWER position; then check and refill the reservoir, if necessary.

**Note:** The recommended type of fluid for the cab tilt system is CF-A (MIL-H-5606E); the approximate capacity is 1.4 liters (3 pints).



### WARNING

**The pump control lever must be in the LOWER position before operating the vehicle.**

## 94 OPERATION

---

### DOORS

#### Opening the Cab Door

The inside door handles are flush-mounted, with paddle-type design. To open the door, grasp the handle and pull out while exerting some force on the door.

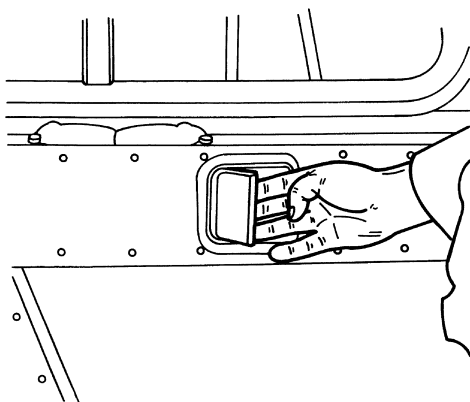

C0029618

**Note:** If the door is locked, slide the button to unlock the door before pulling the inside paddle handle.

#### Locking the Cab Door

To lock with the door open, press the door handle inward and shut the door.

To lock with the door closed (from the inside), slide the lock button down; to unlock, slide the lock button up.

#### Right-Side (Folding) Door



#### CAUTION

*Be sure not to disturb the rear view mirror when folding and unfolding the right-side door.*

#### *Folding the Door*

1. Open the right-side door. Note that the right-side door opens the same way as the left side, using a paddle-type handle.

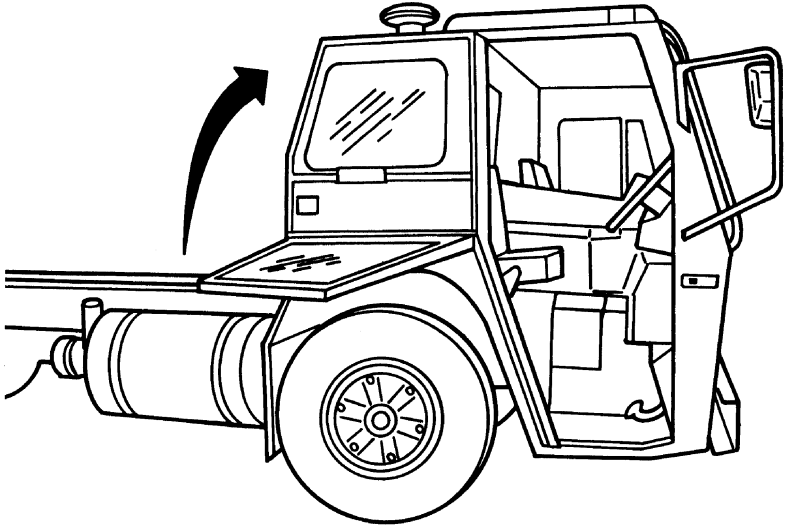

C0029619

2. With the door open at least halfway, lift up on the door bottom and fold the door in half (refer to the illustration).
3. Push the bottom half of the door tight against the top half to secure the folded door.
4. In this position, the door latch will act as a holding device to secure the bottom half of the door. There is also a rubber ball-and-socket arrangement that will interlock (with about 6 or 7 pounds of pressure) at the door top and bottom.
5. Push against the folded door to securely latch it to the catch on the rear of the cab.

### ***Unfolding the Door***

Before returning the right-side door to its whole-door configuration, it must be securely latched to the back of the cab.

## 96 OPERATION

---

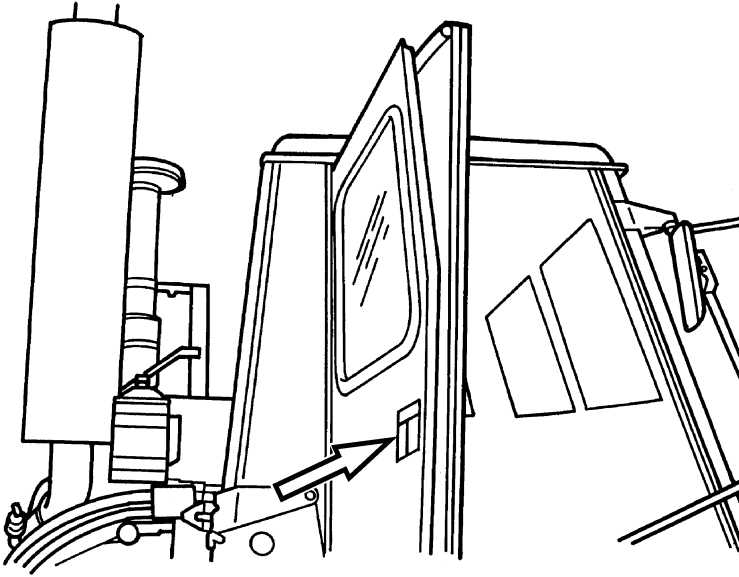

C0029620

1. Pull the paddle handle door latch (see arrow) and use both hands to support the door while unlatching the ball and socket (which is holding up the lower half of the door). Refer to the illustration.
2. While supporting the folded door section with your right hand, pull the lanyard cord (see arrow) to unlatch the door assembly from the cab. Refer to the illustration.

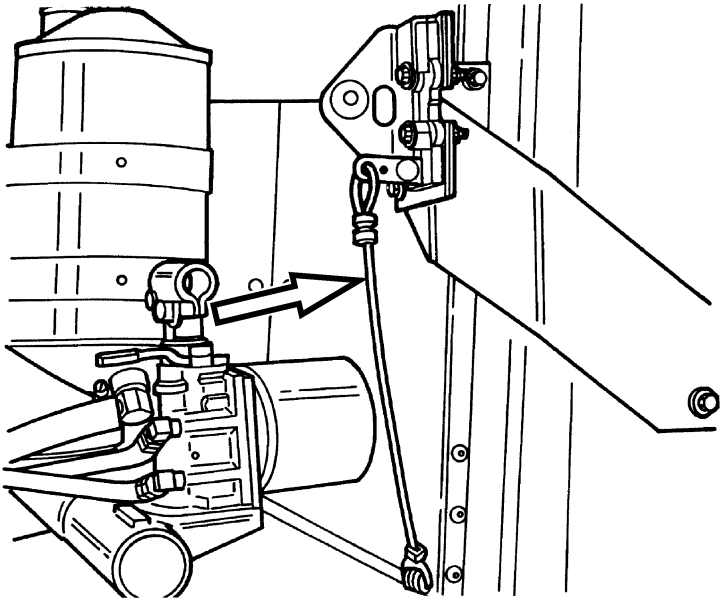

C0029621

3. Pull the door about six inches away from your body, and carefully lower the folded section to the whole-door position.

### ***Bi-Fold Doors***

The LEU model can be equipped with optional bi-fold doors on both sides of the chassis. Procedures for unfolding and folding the door are the same on both sides of the vehicle.

## **Folding the Door**

1. Disconnect the door limiting strap by pulling the loop of the strap over the end of the post on the door.

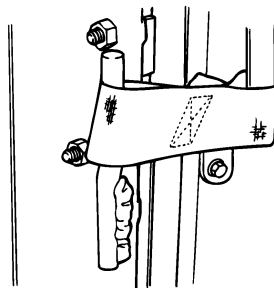



## 98 OPERATION

---

C0029622

2. Rotate the bi-fold latch handle upward to disengage the slot. Pull the handle rearward to unlatch the bi-fold door panels.

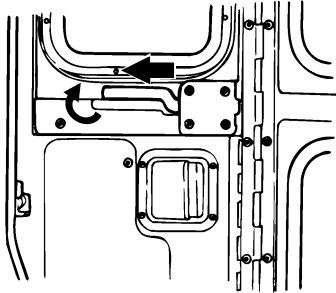

C0029623

3. Fold the two door panels until they latch together. In this position, the cab door latch acts as a holding device to secure the bi-fold panels together.
4. Open the door fully until engaging the latch at the front of the cab that holds the door in the fully opened position.

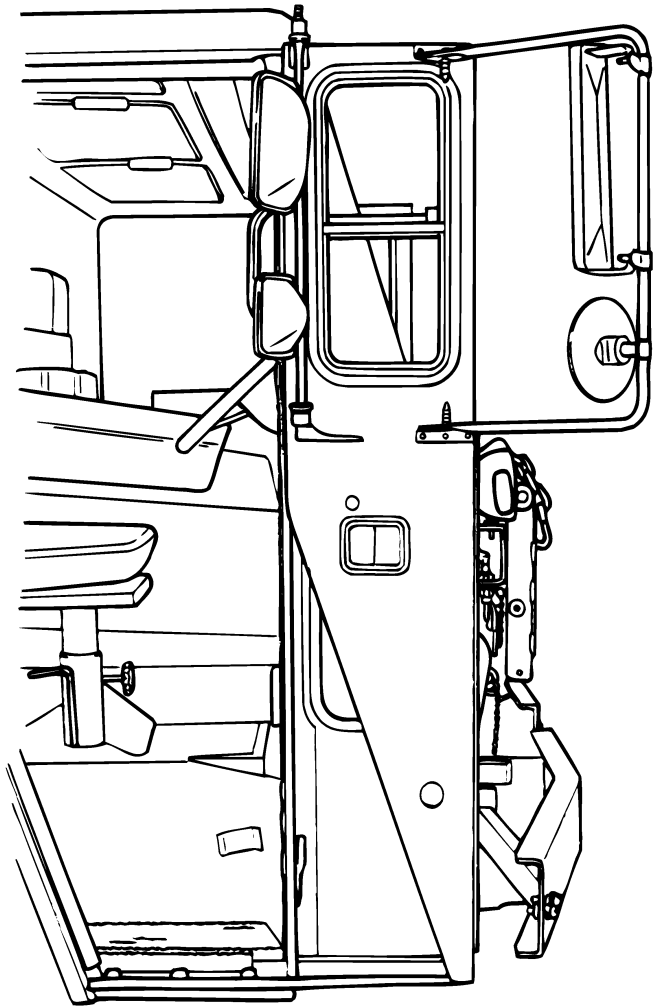

C0029624

# 100 OPERATION

---

## Unfolding the Door

1. Push the door latch lever located on the front of the cab to disengage the door panels from the cab.

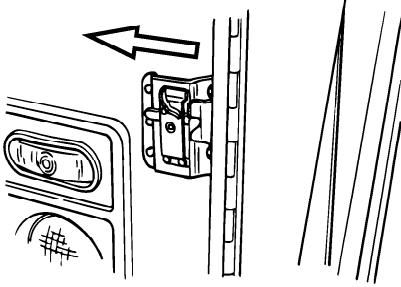

C0029625

2. Pull the outside door handle to separate the two door panels.

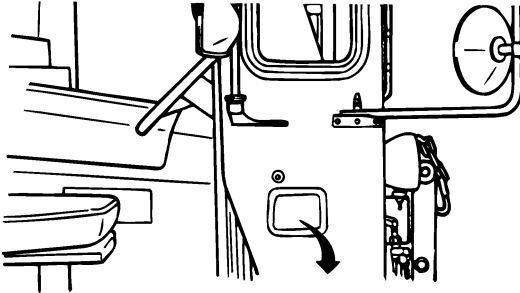

C0029626

3. Unfold the door panels.

4. Slide the bi-fold door latch handle forward to lock the two panels together. Rotate the lever downward to lock the handle in place.

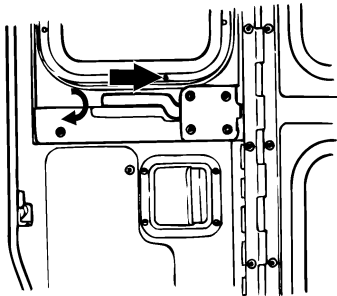

C0029627

5. Reinstall the door limiting strap.

# 102 OPERATION

---

## SEAT BELTS



### **DANGER**

*Seat belts should always be secured **BEFORE** the vehicle is set in motion. Failure to use seat belts can result in **SEVERE** bodily injury or death. Unbelted riders could be thrown into the windshield or other parts of the cab, or thrown out of the cab entirely.*

## Seat Belt Operation

MACK vehicles manufactured on or after September 1, 1990 must have locking retractable seat belts.

This type of belt is designed to lock (prevent belt travel out of the retractor) only during sudden stops or impacts. This feature allows the operator to move freely under normal conditions. Seat belts cannot be locked by jerking on the belt, except during sudden stops or harsh bumps.

For the left-side seat position, this type of seat uses a combination lap and shoulder belt. For the right-side seat position, there is an automatic locking retractor for the lap belt only, with no shoulder belt. The belt will relock at about one-inch intervals as it rewinds into the retractor. Be sure to pull enough webbing out of the retractor before stopping to insert the end of the belt into the seat belt buckle. Once it is buckled, the retractor will pull up the excess webbing and relock.

## Fastening Seat Belt

1. Pull clip so the belt crosses your shoulder and lap and insert it into the buckle until an audible snap is heard.



### **DANGER**

*Use the shoulder belt only on the shoulder that is closest to the vehicle door. Never wear the shoulder portion of the belt under your arm or behind your back. Improper use will increase your chances of injury during a collision.*

**DANGER**

*To prevent possible injury the belt must be positioned low over the pelvis, below the abdomen. If the belt is buckled too high, it will apply force to the abdomen, not the pelvic region, and could cause serious internal injuries during a sudden stop.*

**DANGER**

*Do NOT wear seat belt loosely. Do NOT use one belt for more than one person.*

2. Make sure the clip is securely fastened into the buckle.

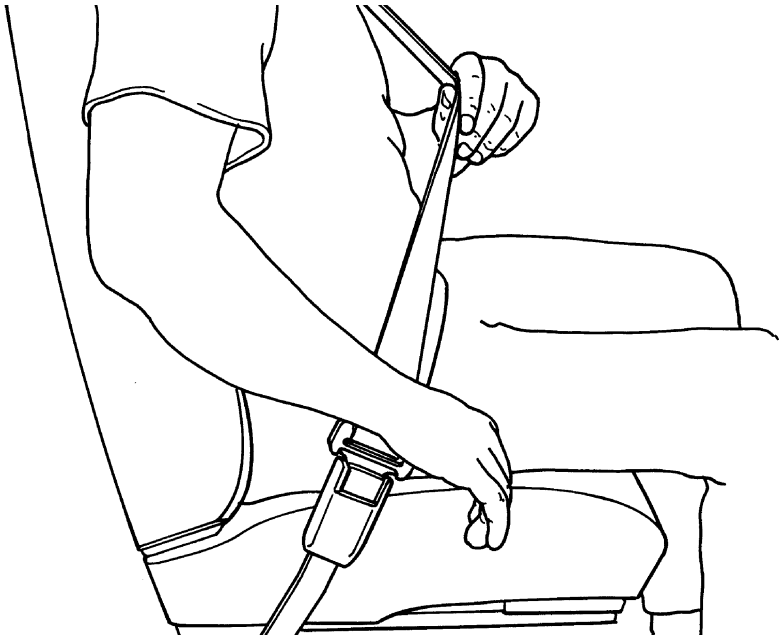

C0029326

3. To tighten the lap portion of the combination belt, pull upward on the shoulder portion until the lap portion fits snugly. The belt should rest as low on your hips as possible.

# 104 OPERATION

---

## ***Unfastening Seat Belt***

Push down on the button to release the belt.

## ***Seat Belt Maintenance***

- Keep belt clean and dry.
- Clean with mild soap solution and lukewarm water.



## **DANGER**

***Do NOT bleach or dye belt, as this may cause severe loss of strength. Do NOT install belt in a truck with a weakened floor until the floor has been replaced or reinforced.***

- Periodically inspect the following areas and replace any inadequate parts:

**Buckle and Latchplate** — The buckle and latchplate should mate easily with a solid click and release easily and quickly with moderate pressure on the release button. All metal seat belt components should be free of signs of damage, corrosion or rust.

**Webbing** — The webbing should show no signs of wear, fraying or holes, and it should be reasonably free of dirt which could find its way into the retracting mechanism.

**Retractors** — The retractors should function smoothly and maintain an appropriate amount of tension. Loose webbing is an indicator that maintenance is needed; it's likely that a too-loose belt will fail to tighten properly when necessary.

**Seat Belt Mounting Components** — The tethering should be free of wear and debris; the webbing should show no signs of wear, fraying or holes; and the metal components should be free of signs of damage, corrosion or rust.



## **DANGER**

***Seat belt assemblies must be replaced after an accident if they have been subjected to loading by occupants (even if no damage is obvious), or if they have been damaged by an accident (bent retractor, torn webbing, etc.). If there is any question regarding belt or retractor condition, replace the appropriate part.***

---

## RIGHT-SIDE RESTRAINT

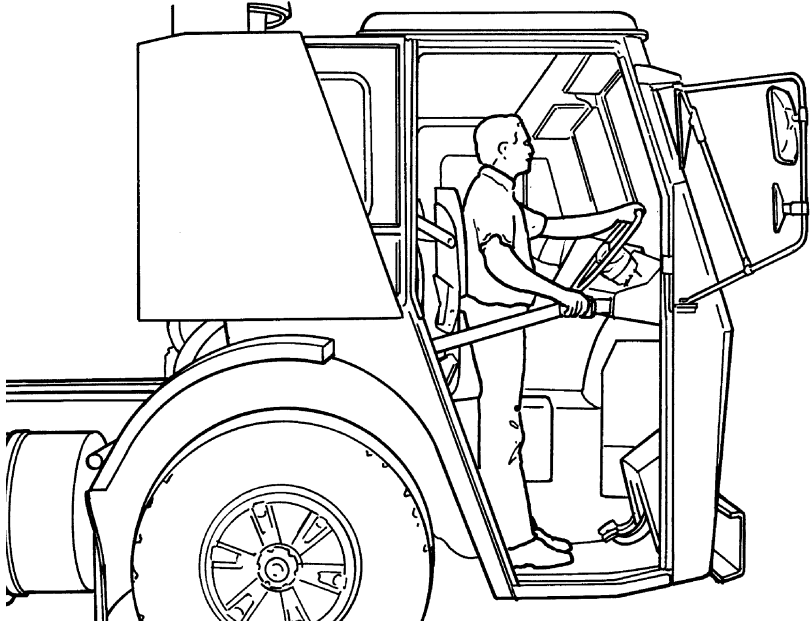

C0029628



### **DANGER**

When the seat is in the standing (drive) position and the door is open, pull out the orange-colored retractable webbing and engage the end into the buckle in the instrument panel. This will serve as a door-opening restraint.



## SEAT ADJUSTMENT

### Right-Side Folding Seat

**Note:** This vehicle was designed as a left-hand drive cab with right-hand operating position. It is possible to operate this vehicle from either side, but the person on the right must be seated to ride and must stand to drive.

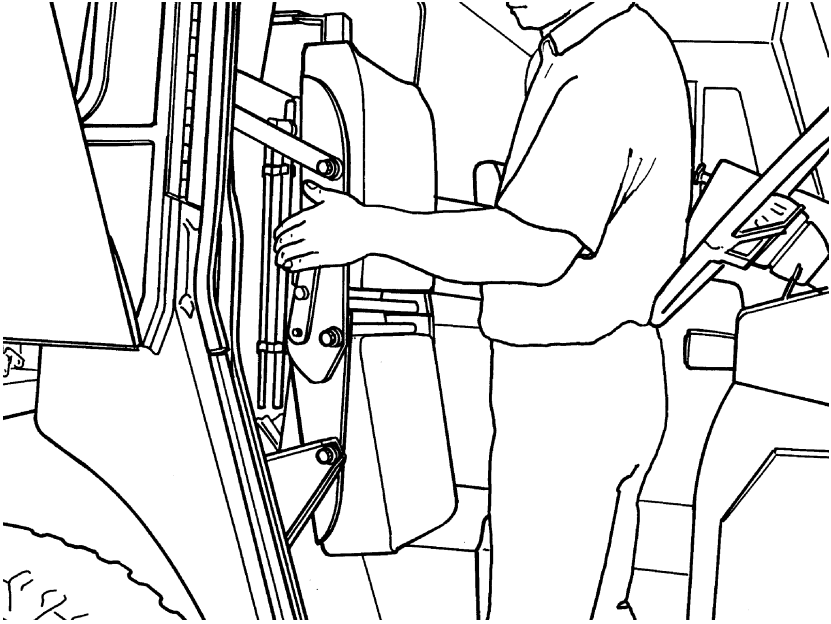

C0029629

Stand facing the seat. Reach behind the seat and pull on the latch. Fold the seat to a vertical position to stand, or set it level for the seated position.



**DANGER**

*Seat belts must be worn at all times while operating this vehicle.*

## Air Seat

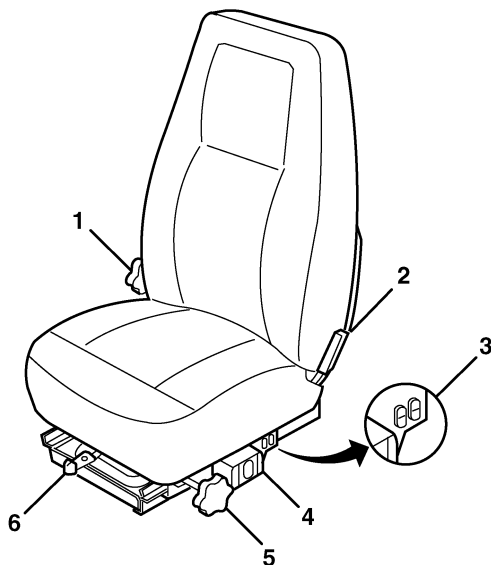

C0029630

<p>1. Lumbar Adjustment Knob</p> <p>2. Seat Back Adjustment Lever</p> <p>3. Optional Air Lumbar Adjustment Button (Upper and Lower)</p>	<p>4. Weight and Height Adjustment Button</p> <p>5. Seat Cushion Tilt Adjustment Knob</p> <p>6. Fore/Aft Adjustment Lever</p>
---	---



### **DANGER**

*Do not make seat adjustments while the vehicle is in motion, as this could cause a loss of vehicle control, resulting in an accident which results in severe personal injury or death.*

### **Lumbar Adjustment**

Rotate the knob [1] forward to increase or rearward to decrease the support in the lumbar area.

### **Seat Back Adjustment**

# 108 OPERATION

---

1. Lean forward slightly to remove your weight from the seat back.
2. Pull the seat back angle adjustment lever [2] rearward to release.
3. Adjust the seat back to the desired position within range of adjustment, then release the handle to lock the seat back into place.

## ***Air Lumbar Adjustment Button (Optional)***

1. To increase lumbar support, press button [3] forward.
2. To decrease lumbar support, press button [3] rearward.

## ***Weight and Height Adjustment Button***

1. To raise the seat, push the air valve button [4] upwards.
2. To lower the seat, push the air valve button [4] downwards.

When adjusted properly and under normal driving conditions, the seat should not top or bottom against the end limits of the vertical travel. Adjusted height position should aid the driver's visibility and vehicle control.

## ***Seat Cushion Tilt Adjustment Knob***

Rotate the seat tilt knob [5] to decrease or increase seat tilt.

## ***Fore/Aft Adjustment Lever***

1. Hold the fore and aft adjustment lever [6] to the left.
2. Slide the seat to the desired position.
3. Move the lever to the right to lock the seat position. (Isolation of the seat is provided when the lever is in the center [straight] position.)

# MIRROR SYSTEMS

The mirror system for LEU model chassis are designed so that:

- Appropriate mirror views are available from both operating positions.

## Moto Mirror System

The mirrors of the Moto Mirror System can be adjusted at any time (from inside the cab) using the adjustment switches located on the center instrument panel (Panel E).

### *Positioning the Mirrors*

**Note:** The operator must readjust the mirrors when changing between left- and right-operating positions.

There are 2 different styles of mirror mounting arrangements available.

On the first arrangement, the left hand mirror is mounted on the door and the right hand mirror is mounted on the door. Mirrors are positioned in such a way so as to be viewed through the door windows. The mirrors must be readjusted when changing positions as shown in the following illustrations:

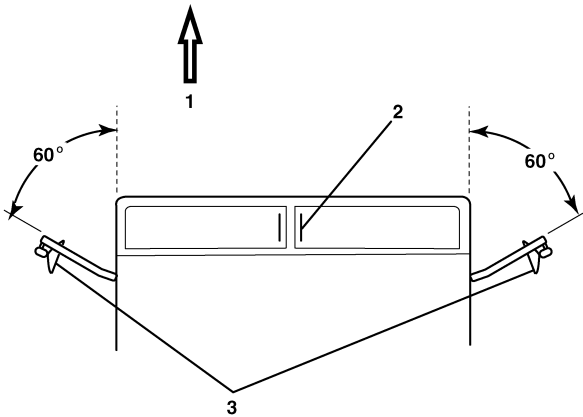

C0029631

1. Forward 2. Wipers Must Park at the "Inboard" Position	3. LH Driving Position
---	------------------------

# 110 OPERATION

---

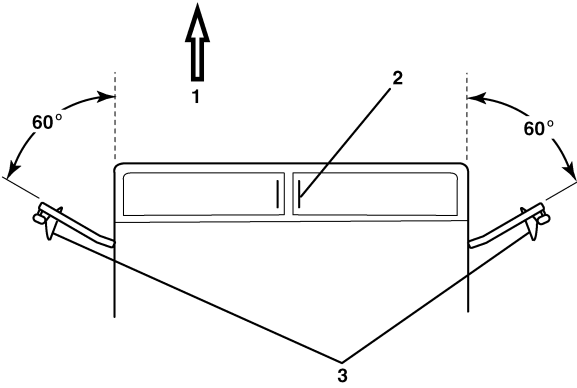

C0029632

1. Forward

2. Wipers Must Park at the "Inboard" Position

3. RH Driving Position

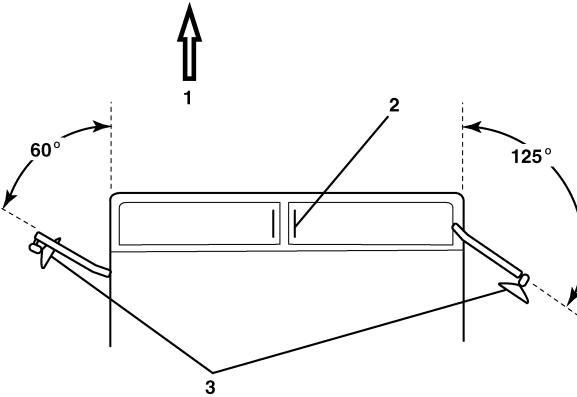

C0029633

1. Forward

2. Wipers Must Park at the "Inboard" Position

3. LH Driving Position

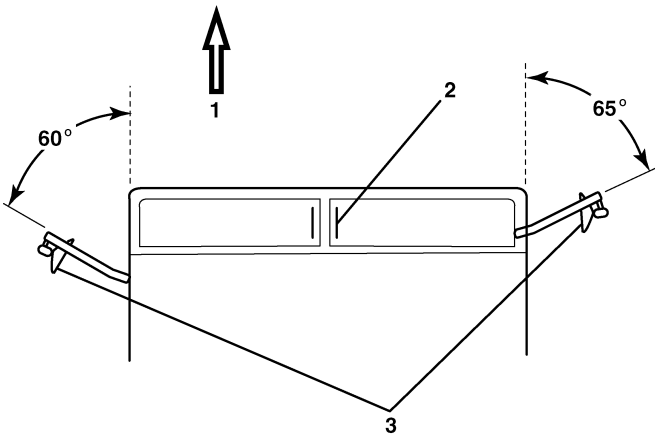

C0029634

1. Forward

2. Wipers Must Park at the "Inboard" Position

3. RH Driving Position

# 112 OPERATION

## MACK ENGINE INFORMATION

For engine starting procedures, refer to “STARTING THE VEHICLE”, page 134.

### Precautions and Warnings



#### CAUTION

*If a winterfront is needed, use only a winterfront that was designed for this specific chassis. Winterfronts are not recommended, but may be used during very cold weather with sustained temperatures below -25°C (-13°F).*



#### CAUTION

*Be sure to avoid high intake/exhaust temperatures when using winterfronts under normal operating conditions (above freezing). The restriction of airflow can cause higher exhaust temperatures, power loss, excessive fan usage and reduced fuel economy.*



#### CAUTION

*If a winterfront is used, a MACK-approved exhaust pyrometer must be installed and closely monitored while the engine is in operation. Do NOT exceed the maximum temperature indicated by the red line on the gauge. To reduce exhaust temperature, downshift or reduce engine power and open the winterfront.*



#### CAUTION

*Do not permit a heavy load to drive the engine above the governed speed. Operate in a gear low enough to allow the engine to accelerate to (or maintain) governed speed when applying the throttle.*

	<h2>WARNING</h2>
<p><b>Misuse or modification of a turbocharger can result in serious injury and property damage. In addition, extreme care must be taken to avoid foreign material induction, excessive exhaust temperatures and lack of lubrication.</b></p>	

	<h2>CAUTION</h2>
<p><i>The maximum allowable engine speed is listed on the warning label on the sun visor. DO NOT exceed 2,300 rpm.</i></p>	

## Engine Model Designations

The MACK engine model designation system uses letters and numbers to provide a complete unit description.

### ***MP Engine ID Letters and Number***

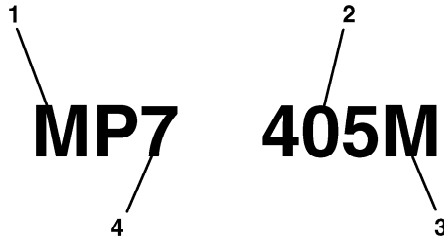

C0029329

### **MP7 Used as an Example**

<p>1. Mack Power</p>	<p>3. Curve Family: Econodyne = E Maxicruise = C Maxidyne = M</p>
<p>2. Peak Horsepower</p>	<p>4. Rounded Cubic Inch Displacement</p>



### CRUISE CONTROL OPERATION

**Note:** Effective August 2008, a change was made to the vehicle software which requires the vehicle operator to press and release the brake pedal after the engine has been started. If the brake pedal is not depressed after starting the engine, cruise control will not function.

### Speed Control Switches

**Resume/Set Switch** — Allows the driver to set and resume cruise control.

**Note:** In most cases, the Speed Control switch must be in the ON position in order to use the Resume/Set switch. However, when the Initial Set Using Resume Switch feature is enabled, cruise control can be activated using the Resume/Set switch.

The Resume/Set switch also functions as the Accel/Decel switch. Usually the Resume position (press the top) corresponds to an increase in engine speed (Accel) and the Set position (press the bottom) corresponds to a decrease in engine speed (Decel).

**Note:** Under specific circumstances this switch can also be used to activate cruise control. For details concerning the Initial Set Using Resume Switch feature, refer to the *V-MAC Support Software User's Guide*.

**Speed Control Switch** — Activates the cruise control system.

At the desired speed, press and release the Resume/Set switch. This speed is now programmed and will be automatically maintained.

**Note:** To increase the engine speed, press and hold the Accel switch until the desired speed is attained, or press the accelerator pedal until the desired speed is attained and then press and release the Set switch.

## **Disengaging Cruise Control**

To turn off the cruise control system, move the Speed Control switch to the OFF position.

**Note:** If the Speed Control switch is moved to the OFF position, the process of setting cruise control must be repeated in order to re-activate cruise control (unless the Initial Set Using Resume Switch feature is enabled).

To temporarily disengage cruise control, disengage the clutch or apply the service brakes.

**Note:** If cruise control is temporarily disengaged using the clutch or service brakes, press the Resume switch to resume the previously programmed speed.

## **MACK POWERLEASH™ ENGINE BRAKE (IF EQUIPPED)**

**Note:** If your vehicle is equipped with a Jacob's engine brake, please refer to the Jacobs Engine Brake Manual supplied with the vehicle for complete operating instructions.

Engines may be equipped to be PowerLeash™ upgradeable. These engines will be equipped with PowerLeash™ camshaft. These engines are identified on the engine information sticker.

If your vehicle is equipped with the MACK PowerLeash™ Engine Brake, it is important that you take the time to become familiar with your engine brake before putting it into operation.



### **WARNING**

**Operation of any vehicle on wet or slippery roads requires extreme caution. Because the engine brake converts the engine to a retarding device, it should NOT be used on wet or slippery roads if the vehicle has a single driving axle or if it has tandem driving axles that are lightly loaded. Use of an engine brake under these conditions can cause the vehicle to skid or a combination vehicle to jackknife.**

## Engine Brake Switch

The Engine Brake switch is located on the dashboard. The Engine Brake switch is a three-position switch located on the instrument panel.

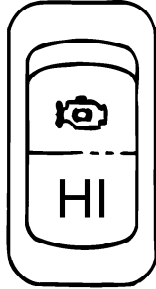

### Engine Brake Switch

- HI Full Engine Braking Power
- LO Half Engine Braking Power
- OFF No Engine Braking Power

C0029330

To operate the vehicle without the engine brake active, leave the dash-mounted switch in the OFF position.



### CAUTION

*The V-MAC® system prevents engine brake activation if the oil temperature is below 55°C (131°F). The driver should be alert to the fact that the engine brake will not function until sufficient warm-up time has elapsed, regardless of the dash switch setting.*

## How the Engine Brake is Activated

When the engine brake is "enabled" (switch in either LOW or HIGH position), your engine V-MAC® electronic control system commands engine brake power (engine brake "active") only when the following conditions are true:

- The foot-operated engine accelerator pedal is not depressed.
- The clutch pedal is not depressed (manual shift transmissions only).
- The engine speed is at least 900 rpm.
- Vehicle must be in gear.
- Vehicle speed should be greater than 8 km/h.

If the engine brake is active, the engine brake will automatically be deactivated by depressing either the accelerator or the clutch, or if the engine speed drops below 900 rpm. As soon as all of the engine brake "active" conditions are again true (taking your foot off the accelerator, for example), the engine brake

will again be activated. In order to disable the engine brake, simply return the dash-mounted control switch to the OFF position.



### DANGER

*The engine brake should never be considered a substitute for the vehicle service brakes. The service brakes should always be maintained in good working order, and should always be viewed as the primary vehicle slowing system. Service brakes are always used to bring the vehicle to a complete stop.*

## Cruise Control with the MACK PowerLeash™ Engine Brake

When the MACK PowerLeash™ Engine Brake is enabled at the same time your V-MAC® cruise control is in use, the engine brake automatically activates when necessary to slow the vehicle to the cruise set point speed. You can select one of two possible options:

- The engine brake is activated 3 kph (2 mph) above the cruise set point.
- The engine brake is activated as soon as cruise control commands fueling to zero (vehicle has just reached cruise set point and fuel has been turned off).

The first option is the more popular choice for highway use and is the default mode. Consult your V-MAC® IV Operator's Manual for more information about this option. Your local MACK dealer can change the current selection.

The engine brake's ability to control maximum vehicle speed is limited to the selected retarding power of the engine brake. If the engine brake dash-mounted control switch is set to the LOW position, only half of the available braking power is used. If the dash-mounted control switch is set to the HIGH position, the cruise control invokes full engine brake power.

**Note:** Deactivating the cruise control function does not disable the engine brake.

The MACK PowerLeash™ Engine Brake may be activated or deactivated by other vehicle systems such as ABS and Headway control systems. Refer to the literature concerning these systems for additional information.

# ON THE ROAD WITH THE MACK POWERLEASH™ ENGINE BRAKE

If you are not familiar with the use and operation of a heavy-duty diesel engine brake, it is essential that you read the following section carefully. It is very important that you take the time to gain experience with your MACK PowerLeash™ Engine Brake in good driving conditions, before using it in difficult or hazardous driving conditions, such as steep descents or slippery roads. Of course, there is no substitute for driver training by a qualified specialist.

The following information is intended as a guideline to safe and appropriate use of the MACK PowerLeash™ Engine Brake. It is difficult to describe every possible driving condition. Certain circumstances may require a more conservative approach than will be described. When encountering any new driving route or situation, err on the side of caution.

## Over Flat Terrain

The LOW power position is likely adequate to control vehicle speed in situations where the roadway is relatively flat or has modestly graded rolling hills, and if total vehicle weight is light.

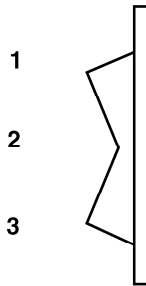

C0029331

<p>1. High 2. Low</p>	<p>3. Off</p>
---------------------------	---------------

# 120 OPERATION

As grades and vehicle weight increase, it will be necessary to use the HIGH position.

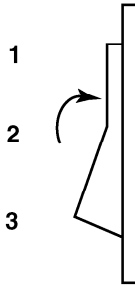

C0029332

1. High  
2. Low

3. Off

## Descending a Grade



### DANGER

*The MACK PowerLeash™ Engine Brake assists you in establishing faster downhill descent speeds than in a similarly configured and loaded vehicle without an engine brake; nevertheless, even with an engine brake, there are limits to the maximum vehicle speed at which you can travel on downhill grades and still keep your vehicle safely under control. Always approach these situations with caution, and gain the experience necessary for each grade and driving condition to determine the appropriate downhill descent speed.*

For a certain vehicle and load condition, a "control speed" may be established for a given descent. The control speed is the vehicle speed at which the retarding forces of air drag, rolling resistance and engine brake power are equally balanced by the natural force of gravity that causes the vehicle to accelerate down the hill, resulting in a steady, controlled vehicle speed. The additional vehicle slowing power offered by the MACK PowerLeash™ Engine Brake allows the driver to descend the hill in a higher gear than normal (at a faster control speed), without overspeeding the engine.

For example, consider that you are descending a grade with a specific vehicle and an assumed total vehicle weight. You will find that without an engine brake, you must descend this grade in third gear to maintain a steady 16 kph (10 mph) at 2,000 engine rpm, without the need to apply the service brakes.

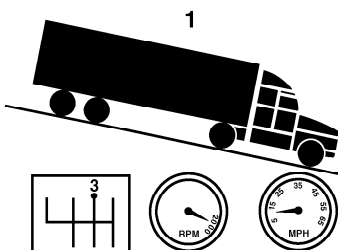

C0029333

## 1. Descent Speed without MACK Engine Brake

Switch the MACK PowerLeash™ Engine Brake to the HIGH position, and now it is possible to descend the same grade in sixth gear to maintain a steady 56 kph (35 mph) at 2,000 engine rpm.



### CAUTION

*The maximum allowable engine speed is listed on the warning label on the sun visor. Do NOT exceed 2,300 rpm.*

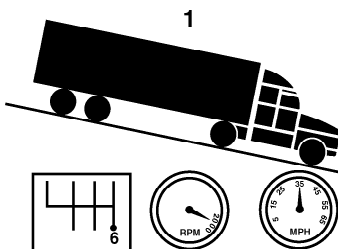

C0029334

## 1. Descent Speed without MACK Engine Brake



## 122 OPERATION

---

In any gear selection higher than sixth gear (in this example), it would be necessary to occasionally apply the service brakes to maintain a safe vehicle speed and to avoid overspeeding the engine.



### DANGER

*As with any vehicle, regular and excessive application of the service brakes during a downhill descent can lead to a brake lining overheat condition, resulting in a very dangerous loss of service brake retarding capability.*

**Note:** The previous figures apply only to this hypothetical example. Specific vehicle control speeds and engine speeds for a given descent are dependent upon the actual vehicle and engine configurations, the gross weight of the vehicle, and the percent grade of the road.

## On Slippery Road Surfaces

As with many aspects of operating a heavy-duty vehicle, special care should be taken when using the MACK PowerLeash™ Engine Brake on slippery road surfaces. The potential for unpredictable loss of vehicle traction is a serious concern; in some situations the engine should not be used at all.

As always, approach untested driving conditions with caution. Avoid use of the MACK PowerLeash™ Engine Brake in these situations until you have gained some experience under normal driving conditions.

As a rule, make sure that the vehicle is demonstrating good tractability with the engine brake off before checking for tractability with the engine brake enabled. Then, provided traffic conditions are safe for "testing" tractability, switch the MACK PowerLeash™ Engine Brake to the LOW position. If the vehicle shows any signs of loss of control (ABS activation or vehicle swerving, for example), immediately switch the engine brake back to the OFF position.

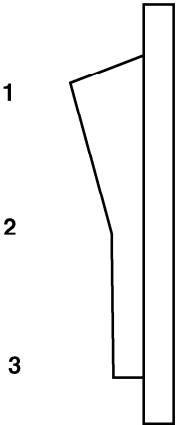

C0029335

1. High 2. Low	3. Off
-------------------	--------

Only if the vehicle demonstrates good control in the LOW position (again, only in safe driving conditions) should you test in the HIGH position, if desired. Return to the LOW position and proceed with caution if there is any sign of loss vehicle control.

**Note:** Always monitor vehicle tractability in slippery road conditions, and make adjustments to engine brake switch position and vehicle speed as necessary. Always test the LOW power position setting before moving to the HIGH position.

Your MACK PowerLeash™ Engine Brake and ABS control systems are designed to work together for optimized vehicle control. The engine brake function may be modified or interrupted briefly in the event of pending wheel lock.

## BRAKE OPERATION

### Air Brake System

This chassis features a dual braking system which has two complete air circuits: a primary circuit for rear brakes and a secondary circuit for front brakes. Each circuit receives air from separate reservoirs. Although there are two air circuits, they operate as one brake system through the dual-circuit treadle valve. This provides the driver with easy, graduated control when applying and releasing the brakes.

The air pressure in the two circuits is monitored by gauges on the instrument panel. When air pressure drops below  $517 \pm 34$  kPa ( $75 \pm 5$  psi) in either system at any time other than vehicle startup, pull to the side of the road and determine the problem. If air pressure continues to drop below  $40 \pm 5$  psi in BOTH systems, spring brakes will automatically apply. The Low Air Pressure Warning indicator and buzzer will be activated if low air pressure occurs in either circuit.

In tractor applications, the Trailer Supply Valve (red octagonal knob) will immediately pop out in the event of a trailer breakaway or sudden trailer air line failure, which will apply the trailer spring brakes. In the event of a slow leak in the trailer air system, the trailer supply valve will pop out when system Pressure reaches 70 psi. This protects the tractor air system from further pressure loss.

If the Trailer Supply Valve is held in, in an attempt to override application of the trailer spring brakes, the Park Brake Valve (yellow diamond knob) will automatically pop out and apply the parking brakes when system pressure drops to approximately 20–30 psi.

The air brake system consists of three main elements:

- The compressor, governor and reservoirs supply and store the air pressure.
- The brake application valve controls the brake application pressures.
- The brake chambers control the brake mechanism.

### ***Air Brake Operation***



#### **CAUTION**

*Avoid sudden stops. Constant, sudden stops may negatively affect the performance of braking and driving parts.*

When slowing for a stop, leave the clutch engaged for as long as possible to use the braking effect of the engine. When forward speed has dropped to a little above idling speed, push clutch pedal in and brake to a complete stop.

## Automatic Slack Adjusters

Automatic slack adjusters are designed to automatically maintain proper brake chamber pushrod travel and compensate for brake lining wear during normal use. Manual adjustment of an automatic slack adjuster should never be performed except when performing brake or wheel service (such as backing off the brake shoes for wheel removal, brake shoe relining/replacement, brake drum reconditioning, etc.).

When pushrod travel exceeds specifications (as given in the "BRAKE ADJUSTMENT" section of the Maintenance and Lubrication Manual, 21394653) on a vehicle equipped with automatic slack adjusters, a mechanical problem with the slack adjuster, brake components or improper installation of the slack adjuster is indicated. If brakes are found to be out of adjustment, the vehicle must be taken to the nearest repair facility to have the problem investigated and corrected.



### DANGER

*Automatic slack adjusters should not be manually adjusted in an effort to correct excessive pushrod stroke, because this condition indicates that a problem exists with the automatic adjuster, with the installation of the adjuster, or with related foundation brake components, which manual adjustment will not fix. Manual adjustment of automatic slack adjusters is a dangerous practice that could have serious consequences, because it gives the operator a false sense of security about the effectiveness of the brakes, which are likely to go out of adjustment again soon.*

## Parking Brake System

Spring-type parking brakes are standard on all single and tandem rear axles.

The spring brake system consists of an air cylinder with heavy springs, which is integrated with the spring brake air chamber. When there is no pressure in the air chamber, the springs expand (causing a brake application). When air pressure is applied to the air chamber, the springs are compressed (releasing the brakes).

## Parking Brake Operation

The parking brakes can be applied and released from the cab, using the hand-operated push/pull control valve with the yellow diamond knob.

In the event of a significant air pressure loss in both the air brake systems, the spring brake air chambers will be automatically exhausted (applying the brakes). The parking brakes will remain applied until enough pressure is available to recompress the springs.

## Parking



### WARNING

- **ALWAYS** apply the parking brakes when parking and make sure the parking brakes are holding the vehicle from moving before leaving the driver's seat.
- When parking on a grade, use wheel chocks under the rear wheels or turn the front wheels to the curb. Do not leave diesel engine vehicles in gear; if the vehicle should move, the engine may start by heat of compression.
- Check brake adjustment frequently to be sure that the brakes will lock and hold the vehicle when parked.
- Do not use the parking brake to slow or stop the vehicle when in motion, except in an emergency.
- Do not use hand control valve for parking.

## Anti-Lock Brake System (ABS)

### **ABS Operation**

When operating an ABS-equipped vehicle, the following guidelines should be used.

- Apply the brakes as normal. If the anti-lock brake system begins to function, maintain brake pressure. Do NOT release the brakes.
- Avoid rapidly pumping the brakes. The anti-lock brake system automatically applies and releases the brakes up to five times per second.

### **MACK Road Stability Advantage (If Equipped)**

The MACK Road Stability Advantage (RSA) is based on the Bendix® ABS-6 Advanced with ESP® (Electronic Stability Program) System. The RSA system aids the operator in maintaining control of the vehicle in the event of a jackknife or rollover situation by applying select brakes and reducing engine power as required by the specific situation. The RSA system, which is integral with the anti-lock brake system, uses the standard ABS components (such as wheel speed sensors and modulator valves) along with a Steering Angle Sensor (SAS-60™) and a Yaw Rate/Lateral Acceleration Sensor (YAS-60™) package to provide information concerning vehicle movement to the Advanced EC-60™ Electronic Control Unit.

In most cases, vehicle repairs will not affect function of the MACK RSA system. However, the following repairs require recalibration of the SAS-60™ sensor after the repair has been made:

- Removal and reinstallation or replacement of the SAS-60™ sensor



### **CAUTION**

*Installation of an aftermarket steering wheel may damage the SAS-60™ sensor. It is therefore recommended that the OEM steering wheel NOT be replaced with an aftermarket wheel.*

- Any repairs to the steering system or front suspension such as:
  - Replacement of front springs
  - Replacement of king pins or bushings
  - Replacement of the steering gear
  - Replacement of the drag link, cross steering tube or ball sockets
  - Replacement of the front spring hangers
  - Replacement of the steering column

# 128 OPERATION

---

- Front end alignment
- Disconnecting the steering column from the steering gear, or the steering linkage from the steering gear



## WARNING

**Failure to recalibrate the steering angle sensor after performing any of the repairs mentioned above, may affect proper function of the RSA system, resulting in a loss of vehicle control due to system intervention at inappropriate times.**

### ***Vehicle Modifications***

Alterations to the vehicle, such as changes to the wheel base (either lengthening or shortening), the addition of an auxiliary lift axle or removal of a factory-installed auxiliary lift axle, or major body changes, such as conversion of a tractor to a truck or an axle, suspension or steering system component modification, are NOT allowed, as these changes will adversely affect performance of the road stability system. Should such changes be unavoidable, the system must be disabled by having a qualified technician replace the Advanced EC-60™ ECU with a Premium EC-60™ ECU.



## WARNING

**Failure to disable the RSA system on a vehicle that has been modified will result in serious vehicle braking and performance issues, including unnecessary system interventions. These interventions could lead to a loss of vehicle control.**

**In addition to disabling the system, any cab labels, such as warning and caution labels relating to the Bendix® ABS-6 Advanced with ESP® system located on the sun visor must be removed, and notations must be made to the operators manuals so that the vehicle operator has a clear understanding as to which ABS options are installed on the vehicle.**

Location of the yaw rate/lateral acceleration sensor must not be altered. When servicing is required, the sensors must be replaced with identical components using the original equipment mounting brackets and tightening torque specifications (20 N.m [15 lb-ft]).

The following additional changes MUST NOT be made to an "as-built" vehicle:

- Changes to maximum steering angle (to the left or right)

- Changes to steer axle and/or drive axle track width
- Changing the front and/or rear brake drums to drums having a different flange thickness

### **Tire Size Calibration**

The ECU requires a precise rolling circumference ratio between the front steer axle and the rear drive axles for optimum performance of the system. For this reason, the system continuously calculates the precise ratio and stores the information in the ECU memory.



### **CAUTION**

*Effectiveness of the RSA system relies on the accuracy of the reported vehicle speed. If major changes to tire sizes are made, such that changes to the vehicle speedometer/odometer settings are required, the Advanced EC-60™ ECU must be reprogrammed with the new values by a qualified technician.*

### **Precautions When Installing Electrical Equipment**

Connecting electrically powered or electrically controlled equipment to the vehicle may cause interference with other vehicle components (e.g., the ABS system). The amount of interference will depend on the operating frequency of any new signals and the degree to which transient signals are coupled into the vehicle system.

**Note:** Whenever new electrical equipment is installed, it is the obligation of the installer to ensure that the new equipment does not interfere with the proper operation of all other electrical systems on the vehicle.

If new electrical equipment is installed, a vehicle checkout procedure should be performed.

1. Perform the checkout procedure under the following conditions:

- Engine running
- Brake system air pressure in operating range
- Vehicle stationary
- Brake pedal fully depressed

2. Operate the new equipment under all starting, running and shutdown conditions.



## 130 OPERATION

---

3. Listen for signs of air exhausting from ABS modulator valves (which is an indication of an interference condition).
4. Correct all interference conditions before operating the vehicle.

### **Automatic Traction Control (ATC) (If Equipped)**

Automatic Traction Control (ATC) provides improved traction on slippery surfaces by reducing wheel spin. The system operates automatically as follows:

- If a drive wheel starts to spin, ATC applies air pressure to the brake of the spinning wheel. Doing this transfers engine torque to the wheels that have better traction.
- If all drive wheels are spinning, ATC limits engine torque which, in turn, reduces wheel spin to provide improved traction.

When ATC automatically becomes active, the ATC indicator lamp turns on to alert the operator. The lamp turns off when the wheel(s) stops spinning.

### ***Heavy Mud/Snow Function (If Equipped)***

ATC may also include a heavy mud/snow function which allows the operator to activate ATC when additional traction is needed. This function is activated with the ATC mode switch which is located on the dashboard. The heavy mud/snow function increases available traction by increasing permissible wheel spin.

When the operator selects the heavy mud/snow function, the ATC indicator lamp blinks continuously. The ATC lamp stops blinking when the ATC mode switch is turned off.

## Work Brake System

The work brake system is designed to be used when frequent stops are made. This type of operation, typical in house-to-house refuse collection, consumes large volumes of air if the spring brake is applied at each stop. The work brake system uses significantly less air volume than the spring brake system, improving overall brake system durability.

In addition, the brake system incorporates backup features which apply the spring brakes in the event of an engine shutdown or significant loss of air pressure. With the work brake applied, spring brake application will occur if the engine should be shut off or if a loss of air pressure is detected in the primary system.

### *Operating the Work Brake System*

**Note:** Always use the foot brake to bring the vehicle to a complete stop before applying the work brake.

In normal operation, when the work brake is applied, the transmission will be shifted into neutral from a forward or reverse gear and both the front and rear axle service brakes will be applied. When the vehicle shifts to neutral from the reverse gear, the transmission must be **manually** shifted back into gear.



### **WARNING**

**Loss of vehicle control could occur if the vehicle is in motion when the work brake is applied (due to wheel lockup on slippery surfaces). In addition, using the work brake before the vehicle is stopped could throw the operator from the normal driving position.**

### *Work Brake Application from a Forward Gear*

To apply the work brake and place the automatic transmission in NEUTRAL:

1. Bring the vehicle to a complete stop with the foot brake.
2. Lift and rotate the work brake lever clockwise (toward the driver).
3. Lower the lever into the locked (applied) position.

## 132 OPERATION

---

To release the work brake and place the automatic transmission back into the previously selected forward gear:

1. Apply the foot brake.
2. Lift and rotate the work brake lever counterclockwise (toward the windshield).
3. Lower the lever into the locked (released) position.

**Note:** Engine speed must be below 900 rpm.

**Note:** When the work brake is applied, the transmission is automatically shifted into NEUTRAL, although the transmission shift selector still indicates flashing "2" gear. Releasing the work brake causes the transmission to shift back into forward gear. If, however, engine speed is above 900 rpm when the work brake is released, the transmission will remain in NEUTRAL but the shift selector will still flash "2" gear. It is then necessary to manually move the shift selector into NEUTRAL, then back into "2" gear to proceed.

### ***Work Brake Application from a Reverse Gear***

**Note:** When applying the work brake with the transmission in a reverse gear, shifting out of NEUTRAL is not automatic and must be done manually.

To apply the work brake:

1. Bring the vehicle to a complete stop with the foot brake.
2. Lift and rotate the work brake lever clockwise (toward the driver).
3. Lower the lever into the locked (applied) position.

To release the work brake:

1. Apply the foot brake.
2. Lift and rotate the work brake lever counterclockwise (toward the windshield).
3. Lower the lever into the locked (released) position.
4. Place the transmission into gear.

---

## **GOOD DRIVING HABITS**

### **Weight Ratings**

Do not overload the vehicle. The gross vehicle weight rating (GVWR) and gross axle weight ratings (GAWR's) for a given model may vary due to the tires, wheels/rims, suspensions, axles and/or frame of a specific vehicle. For safety and durability reasons, do not exceed the GVWR and GAWR's listed on your vehicle's Safety Certification Label.

### **Instruments**

Glance at the instruments frequently. When problems develop, take prompt steps to correct them.

### **Shutting Down the Engine**

After a hard run, allow the engine to idle three minutes before shutdown to stabilize the temperature of all engine parts. Quick shutdowns can cause engine damage and prevent the turbocharger from being properly lubricated. For additional options, see "Shutting Down the Engine", page 139.

### **General Observation**

Make it a habit at stops to walk around your truck and look for fuel, oil and coolant leaks. Also check the condition of tires, wheel nuts, springs and lights. Stop trouble before it stops you!

## STARTING THE VEHICLE

### General Information

Before putting the key in the ignition switch, set the parking (spring) brake, disengage the clutch (if equipped) and put the transmission in NEUTRAL.



#### CAUTION

*Do not engage the starting motor too soon after an incomplete start of the engine, or the starter may be damaged. Wait at least five seconds before attempting to restart the engine.*



#### CAUTION

*If the engine does not start immediately, limit cranking periods to 30 seconds to avoid overheating and damaging the starter.*



#### CAUTION

*Do not rev the engine at start-up. Turbocharger damage may result because lubricants need time to establish a film between moving parts.*

### Push Button Starters

Put the key in the ignition switch. Turn the key clockwise to the first "click" (about two o'clock position) to activate the instruments. Depress the starter button and release as soon as the engine starts. Keep the clutch (if equipped) disengaged until the engine runs smoothly.

## Air Starters

On chassis equipped with an air starter, make sure that the air pressure gauge reads a maximum of 120 psi before shutting down and parking for the night. This will ensure sufficient air pressure for restarting the engine.



### WARNING

**Make sure clutch is depressed and transmission is in neutral before engaging the starter! Failure to do so could cause the vehicle to jerk forward unexpectedly causing serious damage or bodily harm.**

### Starting MP Engines

Use the following procedure:

1. Crank the engine until it starts.

**Note:** Do NOT apply the throttle pedal during engine cranking.



### CAUTION

*DO NOT engage the starting motor too soon after an incomplete start of the engine, or the starter may be damaged. Wait at least five seconds before attempting to restart the engine.*

*If the engine does not start immediately, limit cranking periods to 30 seconds to avoid overheating and damaging the starter.*

*DO NOT rev the engine at start-up. Turbocharger damage may result. Lubricants need time to establish a film between moving parts.*

2. After the engine has started, warm the engine until the coolant temperature reaches normal operating range 77°C to 107°C (170°F to 225°F). Once the engine reaches this temperature, it can be operated in a normal fashion.

**Note:** Warm-up time can be reduced by increasing engine idle speed between 1000 and 1200 rpm by either applying the throttle pedal or by using the Electronic Hand Throttle feature (if equipped).

**Note:** For bobtail or unloaded applications, the engine may be warmed up by moving the vehicle with "light" throttle application after only one minute of idle.

## Priming the MP Fuel System



### DANGER

*Before working on or inspecting a vehicle, set the parking brakes, place the transmission in neutral and block the wheels. Failure to do so can result in unexpected vehicle movement and can cause serious personal injury or death.*



### DANGER

*To avoid potential fire hazard, do not service any part of the fuel system while smoking or in the presence of flames, sparks or hot surfaces, or when working on an operating engine. Failure to follow these precautions can result in fire. To guard against burns from direct contact with hot fuel, wear adequate protective clothing (face shield, heavy gloves and apron, etc.) when working on a hot engine.*



### WARNING

**DO NOT** work near the fan with the engine running. The engine fan can engage at any time without warning. Anyone near the fan when it turns on could be seriously injured. Before turning on the ignition, be sure that no one is near the fan.

1. Unlock the hand primer pump by pushing the pump handle in and turning it counterclockwise.

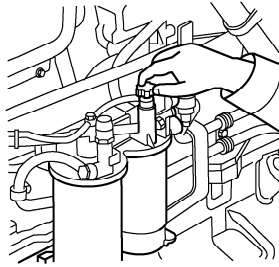

C0029336

2. Pump the hand primer until the force of pumping increases.

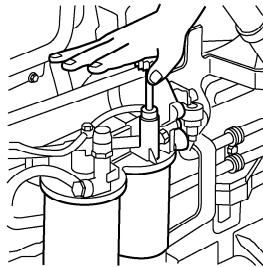

C0029337

**Note:** When the fuel system is empty, 200 or more pump strokes may be needed to properly prime the system.

**Note:** There are NO bleed nipples to be opened in order to prime the fuel system.

3. Lock the hand primer pump by retracting it into the housing and turning it clockwise.
4. Start the engine and run it at an increased idle speed for approximately 5 minutes to remove any remaining air in the system.
5. Check the fuel system for leaks.

**Note:** If the engine does not start following this procedure, contact your local MACK dealer.



## Engine Warm-Up



### CAUTION

*Idling the engine unnecessarily for long periods of time wastes fuel and fouls injection nozzles. Unburned fuel causes carbon formation and oil dilution. NEVER race an engine during warm-up.*

Engine damage can occur if the engine is not warmed up to a minimum operating temperature of 77°C (170°F) before putting the vehicle into full operation.

Heavy-duty diesel engines are designed to operate at optimum efficiency when they are running loaded at (or very near) normal operating temperature, where efficient combustion takes place. When the engine is operated unloaded, lightly loaded (i.e., stop-and-go operations, PTO operations, or periods of extended engine idling) or in cold weather conditions, normal operating temperature may not be achieved or maintained. As a result, carbon and/or varnish build-up will occur and lubricating oil will become contaminated with combustion by-products.

Cold weather operations place added demands on a diesel engine. When operating in cold climates (particularly in stop-and-go operations, PTO operations or periods of extended engine idling), minimum operating temperature must be maintained to prevent engine damage resulting from valve varnishing and carbon build-up.

**Note:** Many accessories are available for cold weather operations. Refer to the Maintenance and Lubrication Manual (21394653) for additional information concerning cold weather accessories.

## Engine Idling

Idling the engine unnecessarily for long periods of time wastes fuel, fouls injector nozzles and can lead to valve carbon and varnish deposits. Unburned fuel causes carbon formation and oil dilution. Shut the engine down when prolonged loading or unloading of cargo is required.

When starting a cold engine, or if the vehicle has been parked and the engine coolant has fallen well below normal operating temperature, a fast idle speed of approximately 1200 rpm should be maintained to help the engine warm up more quickly.

## Shutting Down the Engine

### **Standard Shutdown**

After a hard run, allow the engine to idle three minutes before shutdown in order to stabilize the temperature of all engine parts. Quick shutdowns can cause engine damage and prevent the turbocharger from being properly lubricated.



### **CAUTION**

*Operating the engine below normal operating temperature for extended periods of time will allow varnish/carbon deposits to build up on the valve stems and guides. This will cause the valves to stick in the guides after the engine has been shut down and could result in push rod damage when the engine is restarted. If the engine has been operated below normal operating temperature for an extended period of time (and the odor of raw diesel fuel is detected or unburned fuel can be seen at the exhaust stack), the engine should be operated under "load" until normal operating temperature is achieved BEFORE shutting down the engine.*

On chassis equipped with an air starter, make sure that the air pressure gauge reads a maximum of 120 psi before shutting down and parking for the night. This will ensure sufficient air pressure for restarting the engine.

### **V-MAC IV Shutdown Option: Idle Cooldown**

This feature provides a means of cooling down the engine and turbocharger. If the idle cooldown option is enabled using VCADS Pro MACK Support Software and the system senses that the turbocharger may be hot, the engine will not shut down when the vehicle stops, the parking brake is set and the key switch is turned to the OFF position. This feature allows the driver to lock the truck and walk away while still providing adequate cooldown. All switched accessories will then turn off once the engine has stopped. If this option is set, the engine can be shut down immediately by cycling the key switch or by pressing the shutdown override switch.

The idle cooldown timer is set to 3.5 minutes as soon as the engine load exceeds 25%, provided that the engine has been running at least 60 seconds. After the load drops below 25%, the timer begins counting down. If the key switch is turned off before the timer expires, the engine will continue to run until the timer reaches zero.

If a pyrometer is installed, the idle cooldown function will use the pyrometer reading, shutting the engine down when the temperature drops below 232°C (450°F), or after 3.5 minutes, whichever comes first.

The default for this option is set at OFF from the factory.

# 140 OPERATION

---

**Note:** The parking brake must be on for the idle cooldown function to work.

## ***Engine Shutdown System (If Enabled)***

The engine is protected by a system that prevents engine damage by shutting down the engine whenever a potentially damaging condition (such as loss of oil pressure, loss of coolant or engine overheating) is detected. If the system detects such a condition, a warning indicator light and an alarm will alert the driver before the engine actually shuts down. Pressing the Shutdown Override Switch on the instrument panel shortly after the vehicle sounds the engine shutdown alarm, allows 30 additional seconds of operation. This process can be repeated several times to safely park the vehicle.



### **CAUTION**

*Continuously overriding the shutdown system may result in severe engine damage.*

**Engine Shutdown Indicator** — During normal operating conditions, this indicator should illuminate as soon as the key switch is turned on. After the engine is started, it will remain illuminated until engine oil pressure reaches normal idling range. During shutdown, if the system detects a condition that could lead to engine failure, the Engine Shutdown indicator will illuminate prior to engine shutdown.

---

## COLD WEATHER OPERATION



### DANGER

***Do NOT, under any circumstances, use starting fluid (ether) on engine whether or not equipped with an inlet manifold air heater element. An explosion can occur.***

### Cold Weather Starting Tips

- Save the batteries. Do not overtax the batteries by cranking the starter for more than 30 seconds without interruption. Allow about two minutes between attempts at starting the vehicle; this allows the starter to cool and the batteries to re-energize.

**Note:** Always make sure that the battery is fully charged in cold weather.

- Use the correct grade of oil for the prevailing winter temperature.
- Drain the fuel tanks and filters regularly to prevent water accumulation in the fuel system. This accumulation can freeze in fuel tanks, fuel lines and filters.



### WARNING

**Do NOT — under any circumstances — add gasoline, alcohol, used oil or additives with metallic particles to the fuel.**

- If the fuel gels and starts clogging filters and small passages, mix a small percentage of No. 1D fuel (kerosene) with Ultra-Low Sulfur (15 ppm max.) No. 2D (diesel) fuel.

**Note:** Adding kerosene is NOT recommended for general use because both performance and fuel economy will be reduced.

- Refer to the *Maintenance and Lubrication Manual (21394653)* for additional cold weather operating information.

## Engine Block Heaters

An engine block heater works by heating the coolant surrounding the combustion chambers. Engine heaters are recommended to help combat the extreme demands of cold weather operating conditions. When the temperature drops, the engine heater can be plugged in overnight. The location of the engine heater power receptacle varies according to vehicle design.

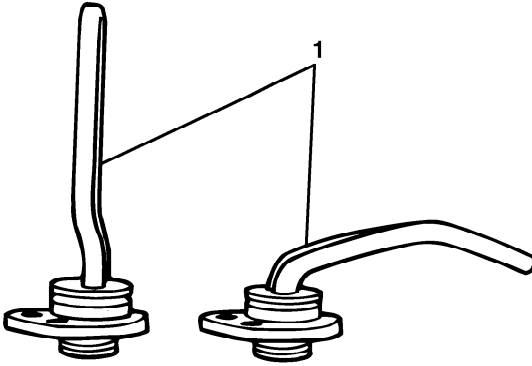

C0029338

1. Engine Block Heaters
-------------------------

### ***Engine Heater Benefits***

- Eliminates cold weather starting problems.
- Increases engine life significantly by keeping the engine warm and avoiding costly, excessive idling.
- Prevents external water leaks caused by excessive cold.
- Allows the cab to heat more quickly.
- Reduces the temperature at which ether is required.
- Allows the engine heaters to be activated as soon as the engine is stopped.

## MOVING THE VEHICLE — GENERAL INFORMATION

### Braking

Avoid sudden stops. Constant sudden stops may negatively affect braking performance and driving parts. When slowing, leave the clutch (if equipped) engaged as long as possible to use the braking effect of the engine.



#### CAUTION

*When using the braking effect of the engine, final gear selection is critical. If gear selection is too high, the vehicle will buck which could cause loss of control.*

### Engine Temperature

Before entering high-speed traffic conditions, allow the engine to reach normal operating temperature. A normal operating range is between 77°C and 104°C (170°F and 220°F) for stationary vehicles.

1. To move the vehicle, begin by starting the engine and waiting until it reaches normal operating range (see Coolant Temperature Gauge in the Instrument Panel section for the correct engine temperature).
2. Shift transmission into the desired gear. Refer to the Transmission Shifting Instructions section for shifting instructions (including the proper starting gear).
3. Release the parking brake.



#### CAUTION

*If the Parking Brake indicator light is on, do NOT attempt to move the vehicle or driveline damage may result.*

4. Apply the accelerator enough for the engine to move the load.

#### **Right-Side Operation**

**Note:** Speed is restricted to second gear when operating the vehicle from the right-hand side.

## 144 OPERATION

---

- Stop the vehicle.
- Put the transmission in NEUTRAL.
- Set the parking brake.
- Go to the right side of the vehicle.
- Flip the switch to the right.

---

## TRANSMISSION SHIFTING INSTRUCTIONS



### CAUTION

*Never coast with the transmission in neutral. Never coast with the clutch depressed.*

### **ALLISON TRANSMISSION SHIFTING INSTRUCTIONS**

For additional information, refer to your Allison transmission manual supplied with your vehicle.

### **Allison 4500 RDS, WTEC III Controls and 4th Generation Controls Shifting Instructions with Allison Transmission Electronic Control**



### WARNING

**Do NOT allow your vehicle to coast in NEUTRAL. There is no engine braking and you could lose control. Coasting can also cause severe transmission damage.**



### WARNING

**If it is necessary to leave the vehicle, even momentarily, while the engine is running, put the transmission in NEUTRAL. Be sure the engine is at low idle (500–800 rpm). Apply the parking brakes and emergency brake and make sure they are properly engaged before exiting the cab. Chock the wheels and take any other steps necessary to keep the vehicle from moving.**





## CAUTION

*The Allison 4500 RDS transmission will not operate in lockup mode when an active ABS fault exists. Prolonged operation of the transmission while an ABS code is active can overheat the transmission oil.*

**Note:** TranSynd™ and the most current specification DEXRON® fluids are recommended for all RDS transmission applications. For more information, please refer to the applicable Allison transmission operator's manual provided with your vehicle.

<b>R</b>	Use this to back the vehicle. Completely stop the vehicle and let the engine return to idle before shifting from forward to reverse or from reverse to forward. The reverse warning signal sounds when this gear is selected. The digital display will display <b>R</b> when reverse is selected.
<b>N</b>	Use neutral when starting the engine, to check vehicle accessories, and for extended periods of engine idle operation (longer than five minutes). For vehicles equipped with the pushbutton selector, neutral is selected by the ECU during start-up. If the vehicle starts in any range other than neutral, seek service immediately. Neutral is also used during stationary operation of the power takeoff (if equipped). The digital display will show <b>N</b> when neutral is selected. Always select neutral before turning off the vehicle engine.
<b>D</b>	The transmission will initially attain first-range when drive is selected. As vehicle speed increases, the transmission will upshift automatically through each range. As the vehicle slows, the transmission will downshift automatically through each range. The digital display will show the highest range available in <b>D</b> (drive).
<b>6</b> <b>5</b> <b>4</b> <b>3</b> <b>2</b>	Occasionally, road, load or traffic conditions will make it desirable to restrict automatic shifting to a lower range. (When conditions improve, the gear selector should be returned to the normal drive position.) These positions also provide greater engine braking for going down grades (the lower the range, the greater the braking effect). Note that even if a lower range is selected, the transmission may not downshift until vehicle speed is reduced. The digital display shows the range selected.
<b>1</b>	Use this gear when pulling through mud or deep snow, maneuvering in tight spaces, or while driving up or down steep grades. First-range provides the vehicle with its maximum driving torque and engine braking effect. Push the down arrow until first-range appears in the select window.

The 4500 RDS shift selector is an electronic control unit with membrane-type push-button switches.

In addition to the R, N, D, Up arrow and Down arrow push buttons, the 4500 RDS shift selector incorporates a MODE button, which allows the driver to enable a secondary shift schedule or other special function.

When you select and depress the desired operating range, a slight click will be felt and a tone will sound.

In D (drive), selection of a specific range can be accomplished by pressing the Up or Down arrow buttons to reach the desired operating range.

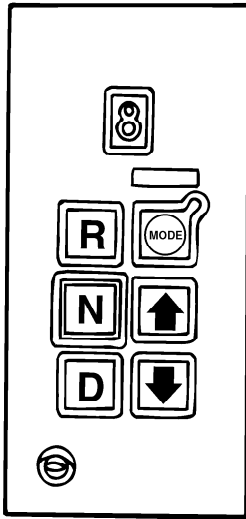

C0029635

## Status Lights

**Check Trans Light** — Illumination of this indicator notifies the driver of a problem with the transmission system and automatically takes action to protect the driver, vehicle and transmission.

For 4500 RDS transmissions, when the Electronic Control Unit (ECU) detects a problem condition, the ECU will restrict shifting, turn on the CHECK TRANS light on the instrument panel, and register a diagnostic code.



### CAUTION

*Applying parking brakes or work brake (if equipped) from the right side of the truck while in DRIVE will force the transmission into NEUTRAL.*

## **Transmission Module Location**

The Electronic Control Unit (ECU) is located in the compartment below the left-side driver seat.

**Note:** Shifting is restricted to second gear when the vehicle is being operated from the right-hand driving position.

**Note:** For body builders, applicable connections have been reduced to one plug which is located in the compartment below the left-side driver's seat.

# 150 OPERATION

---

## AXLES

### Rear Axles Other Than MACK

Please refer to the operators manual provided with your vehicle for axles other than MACK.

### MACK Rear Axles

Mack Trucks, Inc. provides axle housings in three capacity classifications:

- Medium Duty
- Heavy Duty
- Extra-Heavy Duty

To deliver the appropriate amount of torque to the driving wheels, MACK offers dual-reduction carriers in a variety of ratios.

Mack Trucks, Inc. offers a large variety of four-wheel-drive tandem axles with top-mounted, dual-reduction carriers (for straight line through drive). Carriers are also available in a large number of ratios.

All four-wheel-drive tandem carriers are available with the MACK inter-axle power divider third differential (with or without a power divider lockout).

MACK rear axles are designed so the entire load is carried by the axle housing (through the wheel bearings mounted on the housing spindle). The rear axle shafts are either free-splined (both ends) or integral flange type. Both types of axle shafts can be removed without removing or disturbing the rear wheels.

To avoid excessive tire wear, proper maintenance must be practiced and rear axle tires must be matched.



#### CAUTION

*The maximum safe operating oil temperature for a MACK rear axle is 121°C (250°F) for mineral-based oil, and 148°C (300°F) for synthetic-based oil. Continued operation with oil above this temperature will result in rapid deterioration of the oil's lubricating properties and is NOT recommended.*

## ***Inter-Axle Power Divider Lockout (If Equipped)***

The MACK power divider can be rendered inoperative, during short periods of poor traction, using a power divider lockout. When the power divider lockout is engaged, both axles are locked together (in positive through-drive) for maximum traction with no differential action between axles. It is not necessary to stop the vehicle to engage the power divider lockout. The lockout may be engaged while the vehicle is moving at less than 48 Kph (30 mph), as long as the wheels are not spinning.



### **CAUTION**

*Do not engage the power divider lockout if the wheels are spinning.*

**Note:** Even when no traction is available at the spinning wheel, the driver can "feather" the brakes (apply the brakes slightly), creating enough resistance at that wheel to allow power to the axle with traction. Feathering brakes should not be done with power divider lockout engaged.

**Note:** For vendor axles, see the vendor manual furnished with the vehicle.

## **Engaging the Power Divider Lockout**

Normally, the Power Divider switch is in the OUT (disengaged) position. In poor traction conditions, it may be necessary to provide positive through-drive to both axles by flipping the switch to the locked (engaged) position.

1. Push switch to engage.
2. Momentarily release the accelerator pedal to allow the shift to take place, then drive through the slippery area.

**Note:** A lockout indicator lamp will remain lit as long as the lockout is engaged. This is to remind the driver to release the lockout as soon as normal traction is regained.

3. When driving conditions permit, unlock the power divider by moving the Power Divider switch back to the OUT (disengaged) position. Then release the accelerator pedal momentarily (to shift out of the locked position) and drive as usual.

## 152 OPERATION

---



### CAUTION

*Do NOT (under any circumstances) engage or disengage the lockout while the drive wheels are actually slipping or spinning; clashing between the lockout sliding clutch and the outer cam may result.*

### **LIFTABLE AXLES**

Liftable (tag and pusher) axles are used to distribute weight evenly across the chassis so maximum payload can be accommodated with various state weight regulations.



### CAUTION

*Do NOT overload the chassis. Observe the Gross Vehicle Weight rating found on the Safety Certification Label.*



### WARNING

**Do NOT use the tag or pusher axles when the vehicle is empty.**



### CAUTION

*Do NOT lower the tag or pusher axles if the vehicle is moving at speeds above 8 kph (5 mph).*

**Setting Axle Air Pressure** — Tag and pusher axle load is regulated by air pressure. Proper air pressure adjustment is important for maintaining proper steering control and avoiding axle overload.

Axle air pressure should be set to provide proper weight distribution across the chassis and to conform to local weight regulations. In general, a setting of 60 to 70 psi is adequate for most applications, but an accurate setting should be determined by weighing the axles and adjusting the air pressure accordingly.

Adjustable air regulators are located inside the cab to adjust tag and pusher axle air pressure. Pressure is regulated by turning the knob until the proper pressure, as indicated by the accompanying pressure gauge, is reached. Turn the air regulator knob clockwise to increase pressure, or counterclockwise to decrease pressure.



### Extended Idling and Aftertreatment System Conditioning

Extended idling performed on this vehicle equipped with an exhaust aftertreatment system should be carried out at a low engine idle speed. There is no benefit to using a raised engine idle speed for extended idling. The only exception is for active PTO operation. Utilizing an engine speed above 1300 rpm is recommended for vehicles which perform extended idling with an active PTO.

During periods of extended idling, normally greater than 8hrs, the conventional DPF system needs to perform a routine conditioning cycle. The conditioning cycle is controlled by the Engine ECU and will start and stop automatically as needed. The ATS conditioning is required to maintain normal exhaust aftertreatment system function and should not be stopped. ATS conditioning will not occur onTRU DPF systems.

During these events the engine speed will increase to approximately 1050–1400rpm, for non-PTO operation, in order to complete the exhaust aftertreatment conditioning cycle. Exhaust temperatures will also elevate slightly but remain much lower than those reached during regeneration and present no danger.

If a compatible driver display is available a message will be displayed when the conditioning cycle is in progress. The message indicated in the driver's display will be "ATS Conditioning in Progress, No Action Required." If no driver display is available there will be no indication of an ATS conditioning event except for the automatic increase in engine speed.

## DIESEL PARTICULATE FILTERS

Your new MACK chassis is equipped with a 2010 emission compliant engine and an exhaust aftertreatment system which includes a Diesel Particulate Filter (DPF), which reduces soot and particulate emissions into the atmosphere. Vehicles equipped with a Diesel Particulate Filter require the use of EO-O Premium Plus (or VDS-4) specification high performance diesel engine oil and Ultra Low Sulfur Diesel (ULSD) fuel.



### CAUTION

*Use of diesel fuel other than ULSD and engine oils other than EO-O Premium Plus (or VDS-4), will adversely affect performance, efficiency and durability of the DPF system and the engine, to the point where the engine may not run at all. Manufacturers warranties will also be rendered void due to usage of improper fuel. Unapproved fuel additives (including engine oil) are NOT permitted.*

Mack Trucks, Inc. offers two different types of DPF systems:

- Conventional DPF (passive regeneration and parked regeneration)

Thermal Regeneration Unit (TRU) DPF (moving regeneration and parked regeneration)

# 156 Mack, US10 Emissions Solution

---

As well as two different mounting styles:

1. MACK Vertical Back-of-Cab DPF both conventional DPF or conventional DPF or TRU
2. Mack-Cap DPF, which is a space saving unit that is mounted inside the frame (conventional only)

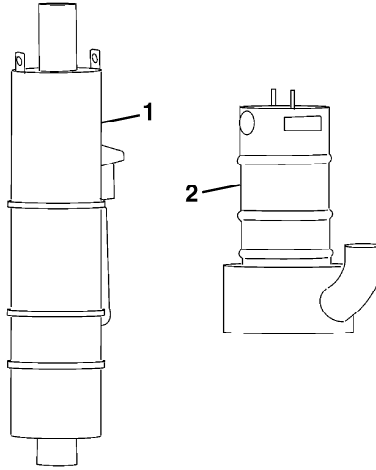

C0029353

A Diesel Particulate Filter (DPF) takes the place of the standard muffler. The DPF is used to meet EPA requirements to help reduce soot and particulate emissions into the atmosphere. The particulates are removed by collecting in the DPF unit, where they are eventually oxidized with passive regeneration or active regeneration of the filter. The electrical system and exhaust aftertreatment system of the vehicle will determine when regeneration is required. Mack Trucks, Inc., uses two exhaust aftertreatment system: conventional and TRU

Conventional exhaust aftertreatment systems use passive-active regeneration. The passive regeneration process oxidizes the particulates captured in the DPF while the vehicle is in operation. An oxidation catalyst raises the exhaust temperature to approximately 260°C (500°F), the temperature at which a chemical reaction takes place to oxidize the soot (passive regeneration).

Conventional exhaust aftertreatment systems are used in highway and certain vocational applications. TRU exhaust aftertreatment systems are used mainly in refuse collection applications.

Depending on how the vehicle is set up, regeneration can occur while the vehicle is being driven (referred to as a "moving" regeneration) or when the vehicle is parked and idling (referred to as a "parked" regeneration).



## CAUTION

*When active regeneration occurs (with either system), the temperature of the exhaust will be elevated. DO NOT park the vehicle with the exhaust outlet under low hanging overhead flammable objects such as trees, awnings, etc., that could be damaged by elevated exhaust temperatures. DO NOT remove the diffuser.*



## CAUTION

*If the vehicle is in a location that may be hazardous when an active regeneration begins (i.e., in close proximity to flammable materials or gases), the regeneration should be stopped by pushing the DPF switch to the "Stop Regeneration" position. If an active regeneration is stopped by the vehicle operator, it should be initiated at a later time when the vehicle is in a safe location. However, if an active regeneration is stopped too many times, the vehicle must be taken to a MACK service facility. The service facility will use a service tool to manually initiate the regeneration.*



## WARNING

**For chassis equipped with a heated dump body, be aware that temperature around the area where the exhaust enters the body, as well as the product contained in the body, may be elevated, particularly during DPF regeneration.**

# 158 Mack, US10 Emissions Solution

## Exhaust Aftertreatment System

### *LEU Standard System View*

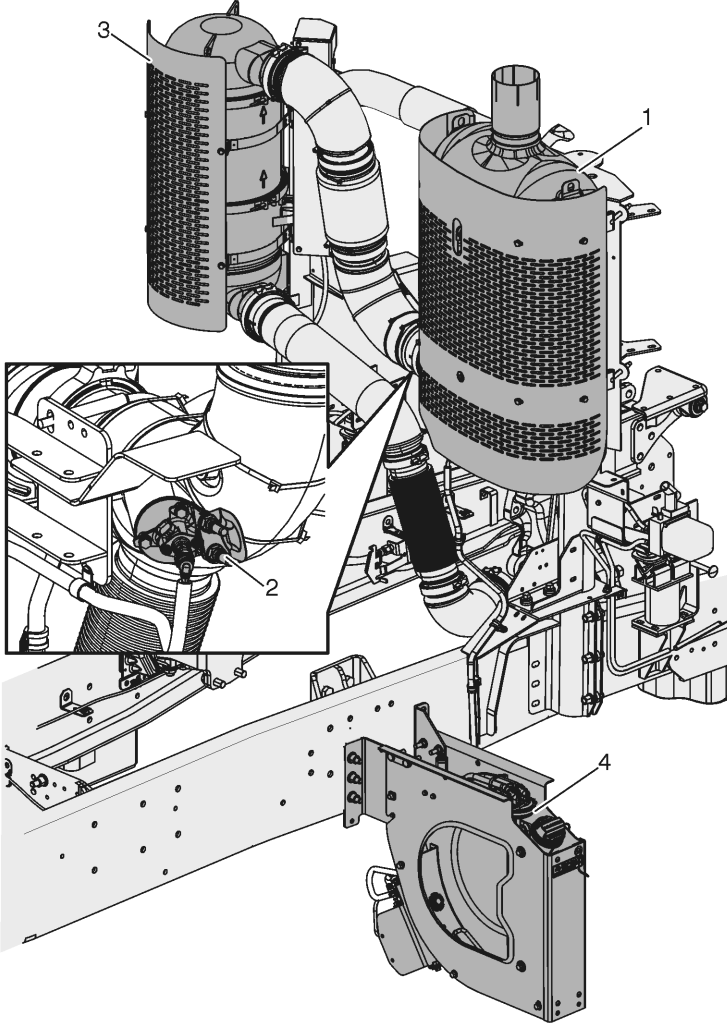

1. Selective Catalytic Reduction (SCR) Catalyst
2. Aftertreatment DEF Dosing Unit
3. Aftertreatment Diesel Particulate Filter (DPF)
4. Aftertreatment DEF Tank

Diesel Exhaust Fluid (DEF) is a reactant that's key to the SCR process. It's a nontoxic, ultra-pure solution of urea and

ultra-pure water. Urea is a compound of nitrogen that turns to ammonia when heated. It is used in a variety of industries, perhaps most commonly as a fertilizer in agriculture. The fluid is non flammable, and is not dangerous when handled as recommended. However, it is highly corrosive to certain metals, especially copper and brass. Read the separate section concerning the handling of DEF solution.

## Safety Information

Mack utilizes the use of a Diesel Particulate Filter (DPF) and Selective Catalytic Reduction (SCR) to meet EPA2010 emissions. The system is designed to require very little driver interface to maintain correct operation. The technology utilizes a passive regeneration; requiring no fuel to be injected to clean the DPF. In EPA2007 an active regeneration (fuel was injected) was required to clean out the DPF producing very high exhaust outlet temperatures. Certain vocational duty cycles will require the use of fuel and/or a parked regeneration to clean out built-up soot in the particulate filter. Exhaust temperatures will increase during a parked regeneration. When parking the vehicle to perform a parked regeneration keep away from any flammable materials, vapors or structures.

### **DANGER**

Exhaust gases and components can be at extremely high temperatures during regeneration. When parking the vehicle, keep away from any flammable materials, vapors, or structures.

### **DANGER**

The temperature of the exhaust system components during the regeneration process can exceed 350 degrees C (660F). The exhaust gas leaving the system can reach 505 degrees C (930F). Various factors (including ambient temperature and duration of the regeneration process) determine when these components will return to normal operating temperature after regeneration has completed. Be extremely careful around these hot components. Contact with these components can result in serious personal injury.

## Exhaust Aftertreatment System Components and

### Selective Catalytic Reduction (SCR)

Selective Catalytic Reduction (SCR) is an emissions-reduction technology with the ability to deliver near-zero emissions of nitrogen oxides (NOx), a smog-causing pollutant and greenhouse gas. SCR's performance has been proved in millions of miles of real-world trucks in other countries, as well as in long-term field tests in the U.S.

SCR reduces NOx emissions to very low levels, while at the same time delivering excellent fuel economy and reliability. The system doesn't change the design or of the basic engine. Rather, SCR is an aftertreatment system which converts NOx in the exhaust stream into harmless gases. Modern diesels already use exhaust

aftertreatment systems, called diesel particulate filters, to control emissions of another pollutant, soot (also known as particulate matter or PM).

SCR works by injecting Diesel Exhaust Fluid (DEF) into the exhaust. DEF is a solution of ultra-pure water and urea. DEF works with the heat of the exhaust and a catalyst to convert NOx into nitrogen and water vapor - two harmless and natural components of the air we breathe. The end result is cleaner air, excellent fuel efficiency and a reliable emissions control system for today's modern diesel engine.

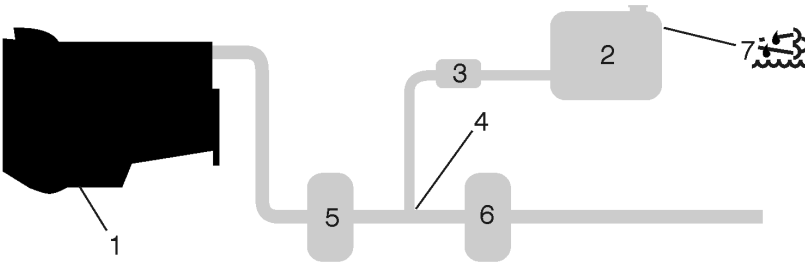

W2031651

#### System Operation

1 Diesel engine optimized for high performance, low particle emissions and low fuel consumption.

2 Aftertreatment DEF tank

3 The Aftertreatment Control Module (ACM) continuously monitors and adjusts the DEF injection rate.

4 DEF is injected into the exhaust gases in between the Aftertreatment DPF (5) and the SCR catalyst (6).

5 Aftertreatment Diesel Particulate Filter (DPF).

6 In the SCR catalyst, nitrogen oxides are transformed into harmless nitrogen gas and water.

7 The system notifies the driver when it is time to refill tank with DEF.

The advantage of using DEF is that it enables the engine to use less EGR -- and higher oxygen levels -- for better combustion, while meeting the EPA NOx emissions requirement. By using DEF, we avoid the disadvantages of increasing EGR to massive levels. This results in better fuel economy from your Mack engine.



W2055490

Vertical SCR, side inlet



## CAUTION

Do not put diesel fuel in the Aftertreatment DEF tank. Diesel fuel, if sprayed into the hot exhaust along with the DEF, could ignite explosively causing a fire resulting in personal injury or damage to the exhaust system.





W3036787

## Diesel Exhaust Fluid (DEF)

Diesel Exhaust Fluid (DEF) is a reactant that's key to the SCR process. It's a nontoxic, ultra-pure solution of urea and ultra-pure water. Urea is a compound of nitrogen that turns to ammonia when heated. The fluid is non flammable, and is not dangerous when handled as recommended. However, it is highly corrosive to certain metals, especially copper and brass. Read the separate section concerning the handling of DEF solution.

Use only **Diesel Exhaust Fluid** that is **clearly labeled as meeting ISO-22241** standards, and **certified by the American Petroleum Institute**. The container **must display the API certification seal**. **Never use agricultural or industrial grade**

**urea**. Use of fluids other than API certified Diesel Exhaust Fluid will compromise aftertreatment system performance, increase emissions, and may impact your product warranties. **Never dilute DEF with water or any other fluid.**

It is recommended that DEF not be stored in extreme hot or cold conditions, or for prolonged periods. Follow the instructions for proper storage and handling as indicated on the container or provided with the purchase.

**Note:** Agriculture mixtures are not pure enough for use in the SCR system and impurities in the solution will comprise the SCR system.

## Diesel Exhaust Fluid (DEF) Handling

When handling DEF solution, it is important to prevent contact with electrical connections. There is a risk that the DEF will cause oxidation that cannot be removed. Water or compressed air do not help, since DEF quickly oxidizes certain metal. If a disconnected connector comes into contact with the DEF solution it must be replaced immediately to prevent the DEF solution from creeping further into the copper wiring.

CAUTION

When detaching hoses and components, do not spill DEF on disconnected or unsealed connectors. If DEF is spilled on a disconnected or unsealed connector, the connector must be replaced immediately.

### Things to know about spilled Diesel Exhaust Fluid (DEF)

If DEF solution comes into contact with the skin: rinse with plenty of water and remove contaminated clothing.
If DEF solution comes into contact with the eyes: rinse for several minutes and call for medical help if necessary.
If inhaled: breathe fresh air and call for medical help if necessary.
Do not allow the DEF solution to come into contact with other chemicals.
The DEF solution is not flammable. If the DEF solution is exposed to high temperatures, it breaks down into ammonia and carbon dioxide.
The DEF solution is highly corrosive to certain metals, including copper and brass.
If the DEF solution is spilled onto the vehicle, wipe off the excess and rinse with water. Spilled DEF solution can form concentrated white crystals on the vehicle. Rinse off these crystals with water.

**Note:** Do not flush DEF spillage into the normal drain system.

## Diesel Exhaust Fluid( DEF) Consumption

DEF consumption is related to fuel consumption. A highway truck may travel 225–300 miles or more on one gallon of DEF. A gauge much like a fuel gauge will indicate the level of DEF in the tank. A DEF low-level warning will activate when DEF is low. If a driver runs out of DEF

completely, vehicle power will be reduced. When the DEF tank is refilled, the engine will resume normal power.

**Note:** DEF tanks are sized for a two to one fuel to DEF ratio in order to meet US 2010 requirements.

## Diesel Exhaust Fluid (DEF) Availability

DEF will be available in 2.5-gallon containers, 55-gallon drums, 275 gallon IBC and in bulk storage for fleet locations, truck stops and dealerships. All major truck stops, dealers and distributors will

carry DEF. DEF will freeze at –11 degrees C (12 F). DEF needs to be protected from extended periods of severe cold. For more information on DEF and availability please

## 164 Mack, US10 Emissions Solution

---

visit the website [www.Mackscr.com](http://www.Mackscr.com) or

please contact Mack One-Call at  
1-800-866-1177.

## Aftertreatment Diesel Particulate Filter (DPF)



### CAUTION

Use of diesel fuel other than ULSD and engine oils other than EO-O Premium Plus (or VDS-4), will adversely affect performance, efficiency and durability of the Aftertreatment DPF system and the engine, to the point where the engine may not run at all. Manufacturers warranties can also be rendered void due to usage of improper fuel. Unapproved fuel additives (including engine oil) are NOT permitted. Blends of No. 1D and No. 2D grades of ULSD are recommended and allowable for cold weather operations.

The exhaust aftertreatment system virtually eliminates exhaust smoke. White exhaust vapor (water condensation) may be visible during a cold start. If black

exhaust smoke is visible during engine operation, this indicates a problem with the exhaust aftertreatment system. Take the vehicle to an authorized Mack Truck dealer immediately.

Vehicles equipped with a 2010 emission compliant engine have an exhaust aftertreatment system which includes a Selective Catalytic Reduction (SCR) system and a Conventional or TRU Aftertreatment Diesel Particulate Filter (DPF). The Aftertreatment DPF takes the place of the standard muffler, and it reduces particulate emissions into the atmosphere. Soot and other particulate matter are collected by a filter where it is eventually oxidized using a regeneration process. Vehicles equipped with a Aftertreatment DPF require the use of EO-O Premium Plus (or VDS-4) specification high performance diesel engine oil and Ultra Low Sulfur Diesel (ULSD) fuel.

## Aftertreatment Control Module (ACM)

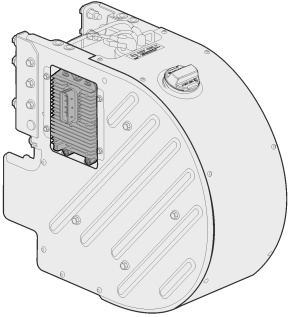

W2029917

The ACM controls the following components in the exhaust aftertreatment system:

- Aftertreatment DEF Dosing Unit
- Aftertreatment DEF Tank Heater Valve
- Aftertreatment DEF Line Heaters
- Aftertreatment DEF Pump
- Aftertreatment DEF Return Valve

The ACM also monitors the following values in the exhaust aftertreatment system:

- Aftertreatment DEF Dosing Pressure
- Aftertreatment DEF Tank Temperature
- Aftertreatment DEF Tank Level
- Aftertreatment DPF Inlet/Outlet Temperature
- Aftertreatment DEF Tank Level Sensor
- Aftertreatment DPF Differential Pressure
- NOX Sensors

The ACM is a stand alone module. Depending on your configuration it may be mounted as part of the DEF tank (as shown above) or on a bracket near the DEF tank.

## Exhaust Aftertreatment System

## Aftertreatment DPF Regeneration

**DPF Smart Switch**– This is a three-position switch where the middle position is neutral.

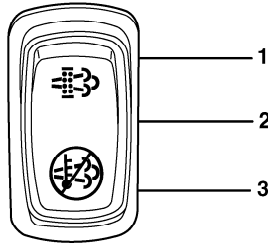

C0029148

### DPF Smart Switch

1. Upper Position – Regeneration Position

2. Middle Position – Neutral Position

3. Down Position – Inhibit Position (if equipped)



### CAUTION

During the Aftertreatment DPF Regeneration, the exhaust gas temperature will be elevated. **DO NOT** park the vehicle with the exhaust outlet near flammable objects such as trees, awnings, etc. that could be damaged by elevated exhaust gas temperatures.



## CAUTION

If the vehicle is in a location that may be hazardous when DPF Regeneration begins (i.e., in close proximity to flammable materials or gases, inside tunnels, parked under flammable objects, etc.), the DPF Regeneration should be stopped (if equipped). If DPF Regeneration is stopped by the vehicle operator, it must be initiated at a later time when the vehicle is in a safer location. Regenerations that are stopped and never restarted at a later time, however, will require that the vehicle be taken to an authorized Mack Truck dealer to have the Aftertreatment Regeneration manually started with special service tools.

**Note:** During vehicle operation, idle speed may increase when the vehicle is stopped at a traffic light to maintain proper Aftertreatment DPF Regeneration conditions.

## Parked Regeneration

When parked regeneration is needed, an icon at the top of the DPF Smart switch will illuminate to notify the vehicle operator. The DPF Smart switch allows the vehicle operator to either stop or start regeneration. (Certain conditions must be met, however, before regeneration can be manually started.)

Parked regeneration allows the operator to start and/or stop the regeneration manually when the vehicle is parked and the engine is idling. The operator is notified that a regeneration is needed when the icons on the DPF Smart switch illuminate. The operator should perform the regeneration as soon as possible.

Please refer to the instructions below on how to use the DPF Smart switch for parked regenerations.

1. Move the vehicle to a safe location, apply the park brake and allow the engine to idle.



## WARNING

**When a regeneration is in process, the temperature of the exhaust will be elevated. DO NOT park the vehicle with the exhaust outlet under low hanging overhead flammable objects such as trees, awnings, etc., that could be damaged by elevated exhaust temperatures. DO NOT attempt to regenerate inside a garage or enclosed area if the tail pipe is attached to an exhaust ventilation system as the hose material may not be rated for the high temperature.**

2. Press and hold the top part of the DPF Smart switch momentarily to initiate the regeneration.
3. During regeneration, the icons on the switch will shut off. The HEST indicator on the instrument cluster will light up to notify of high exhaust temperatures.
4. For aftertreatment DPF filter systems, the engine speed may ramp as high as 1,250 rpm.
5. Parked regeneration will take between 45 to 60 minutes to complete.
6. After regeneration has completed and the exhaust temperature has returned to normal, the HEST indicator will shut off.
7. To stop regeneration, press the switch down to the inhibit position (if equipped). When the bottom of the switch is illuminated, regeneration is stopped. The switch will remain locked in this position and the light will stay illuminated. The driver has the option of stopping a regeneration if the vehicle is in an area where elevated exhaust temperatures will pose a hazard (i.e., tunnel, under trees, in an area where there is flammable material, etc.).

**Note:** The HEST lamp will remain On if it comes On during the regeneration, and remain On until the exhaust temperature returns to normal.



## CAUTION

*Failure to perform a regeneration in a timely manner after notification may result in engine derate, a clogged DPF, damage to the DPF and engine shutdown.*



## DANGER

*During the regeneration process, the temperature of the exhaust gases will be elevated. DO NOT park or stop for an extended period under low hanging overhead flammable objects such as trees, awnings, structures, etc., that could be damaged by elevated exhaust temperatures. Further, if the vehicle is being operated in an area where flammable vapors exist, the regeneration process must be interrupted. Failure to heed these cautions may result in fire or explosion causing serious personal injury or death.*



# 170 Mack, US10 Emissions Solution

---

**Note:** If the vehicle is in a location that may be hazardous when an active regeneration begins (i.e., in close proximity to flammable materials or gases), the regeneration should be stopped by pushing the DPF switch to the "Stop Regeneration" position. If an active regeneration is stopped by the vehicle operator, it should be initiated at a later time when the vehicle is in a safe location. However, if an active regeneration is stopped too many times, the vehicle must be taken to a MACK service facility. The service facility will use a service tool to manually initiate the regeneration.



## WARNING

**The temperature of the exhaust system components during the regeneration process 350 degrees C (660 F). The exhaust gas leaving the system can reach 505 degrees C (930 F). Various factors (including ambient temperature and duration of the regeneration process) determine when these components will return to normal operating temperature after regeneration has completed. Be extremely careful around these hot components. Contact with these components can result in serious personal injury.**



## CAUTION

*When the inhibit position is pressed, the switch will remain in a locked position. It is important, therefore, to immediately set the switch back to the neutral position when safe to do so. Failure to set the switch back to the neutral position may result in an engine derate, clogged diesel particulate filter or damage to the filter.*

## DPF INHIBIT ROAD SPEED LIMITING (RSL)

The DPF Smart Switch can be locked into the DOWN (or Inhibit Regen) position by the driver (if equipped). If the DPF Smart Switch remains in the locked position, the following vehicle speed limiting will occur:









- 1 Vehicle Moving. If vehicle is moving with the DPF Smart Switch in the locked (DOWN) position, the vehicle speed will decrease down to 16 kph (10 mph) below the current speed until the driver releases the switch back to the neutral (MIDDLE) position.
- 2 Vehicle Stationary and then Moving. If the vehicle is stationary with the DPF Smart Switch in the locked (DOWN) position and the driver then begins to move

the truck, the vehicle speed will be limited to 16 kph (10 mph) until the driver releases the switch back to the neutral (MIDDLE) position.

Refer to the Exhaust Aftertreatment System Information sun visor label

for additional Aftertreatment DPF information.

### ENGINE EXHAUST AFTERTREATMENT SYSTEMS (EATS)

DEF Indicators:	 (solid)	 (flashing)	 (flashing)+ Message
Diesel Exhaust Fluid (DEF) Condition:	The DEF tank is low.	The DEF tank is empty. Engine is in derate mode.	The DEF tank is empty. The vehicle is limited to 5 mph.
DEF Action:	Refill the DEF tank.	Refill the DEF tank now (before adding diesel).	Refill the DEF tank now (before operating vehicle).
DEF Indicators:	 (flashing)	 (flashing) 	 (flashing) 
Diesel Particulate Filter (DPF) Condition:	The DPF filter is full.	The DPF filter is overfull. Engine is in derate mode.	The DPF filter may be clogged with soot. Engine is in shutdown mode.
DPF Action:	Initiate a parked manual regeneration at next available stop.	IMMEDIATELY stop and initiate a parked regeneration.	Service EATS system immediately.
See Operator's Manual for Further Detail			

# Driver Warnings and On Board Diagnostics (OBD)

## On Board Diagnostics (OBD)

Beginning with your US 2010 compliant Vehicle, On Board Diagnostics (OBD) is introduced. This is very similar to the On Board Diagnostics (OBD) system that has been required on passenger cars for many years.

On Board Diagnostics (OBD) is a system that monitors the functions of emissions related components and alerts

the vehicle operator to any detected need for an emission related repair. When the systems detects a needed repair to an emissions related component it activates the Malfunction Indicator Lamp (MIL).

The list of emissions related components can be found in the Warranty and Maintenance section of this manual.

## Instrument Cluster

The aftertreatment icons are located in the instrument cluster per the following images.

### LEU Instrument Cluster

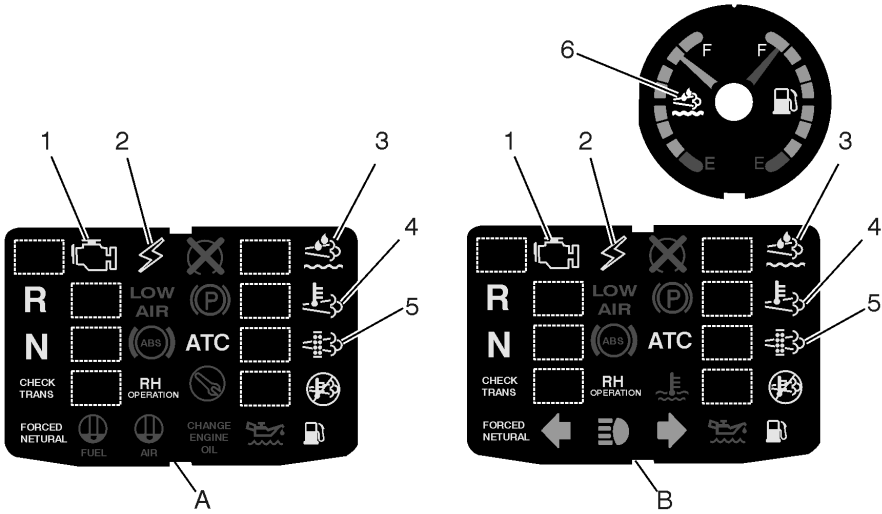

W3031622

A Left Side Indicator Set		B Right Side Indicator Set
1. Malfunction Indicator Lamp (MIL)	2. CHECK Lamp	3. Aftertreatment DEF Low Lamp
4. High Exhaust Temperature (HEST) Lamp	5. Aftertreatment DPF Regeneration Required Lamp	6. Aftertreatment DEF Tank Gauge

# 174 Mack, US10 Emissions Solution

---

## Instrument Cluster Icons

Aftertreatment icons are displayed on the instrument cluster. There are 3 aftertreatment icons:

- Aftertreatment DPF Regeneration Required
- High Exhaust System Temperature (HEST)
- Aftertreatment DEF Tank Low Level Indicator

The Aftertreatment DPF Regeneration Required icon flashes when the Diesel Particulate Filter is becoming full/overfull and regeneration is needed.



W3007445

Aftertreatment DPF Regeneration Required Icon

The High Exhaust System Temperature icon illuminates when a parked Aftertreatment DPF Regeneration is initiated. It also indicates high exhaust gas

temperature during a moving regeneration. When the HEST icon is illuminated, do not park or operate the vehicle near people, or any flammable materials, vapors, or structures.



W3007444

High Exhaust System Temperature (HEST) Icon



W2029416

Aftertreatment DEF Tank Low Level Indicator (DEF)

The Aftertreatment DEF Tank Low Level Indicator icon illuminates when the fluid level is low. It also Flashes when the level becomes critically low.

## Malfunction Indicator Lamp (MIL)

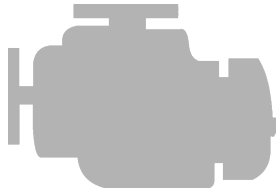

W3031200



MIL Lamp

- MIL indicates government Regulation On Board Diagnostics (OBD) faults
- Lamp may remain active after repair until system confirms repair

## Aftertreatment DEF Tank Level - Driver Warning & Inducement

Aftertreatment DEF tanks are sized to have no less than 2 times the diesel fuel tank mileage or hour range





The vehicle instrument cluster has a Aftertreatment DEF Tank Level Gage

Triggers	Aftertreatment DEF Tank Low Level Indicator	Amber Warning Lamp	Inducement
>12% Aftertreatment DEF Tank Level Gauge	None	None	None
<=12% Aftertreatment DEF Tank Level Gauge	 <small>W2029416</small>	None	None
0% Aftertreatment DEF Tank Level Gauge	 <small>W2029415</small>	None	25% torque reduction
0% Aftertreatment DEF Tank Gauge Insufficient DEF Pump Pressure Diesel Fuel Refueling >15%	 <small>W2029415</small>	None	8 km/h (5 mph) Road Speed Limit (RSL)

**Note:** Vehicle has to be stationary before 8 km/h 5 mph RSL becomes active.

# 176 Mack, US10 Emissions Solution

## Aftertreatment DEF Quality - Driver Warning & Inducement

Triggers	Aftertreatment DEF Tank Low Level Indicator	Amber Warning Lamp	Inducement
Good DEF Quality	None	None	None
Poor DEF Quality DTC Initial Detected	None	 W3031623	None
Poor DEF Quality DTC Initial Detected + 10 hours	None	 W3031623	25% torque reduction
Poor DEF Quality DTC Initial Detected + 20 hours Diesel Fuel Refueling >15%	None	 W3031623	8 km/h (5 mph) Road Speed Limit (RSL)
Temporary Exit from 5 mph Inducement	None	 W3031623	25% torque reduction

**Note:** Vehicle has to be stationary before 8 km/h (5 mph RSL) becomes active.

## **Exit conditions for DEF Quality "5 mph road speed limit" Inducement:**

**First Restart:** Return to 25% torque reduction until proper DEF quality evaluation. If poor DEF quality is detected during the next monitoring cycle then and 5 mph resumed after vehicle stationary for 20 minutes. After the second restart a Service Tool is required to exit the 8 km/h (5 mph) RSL.

## **Misfilling Diesel or Aftertreatment DEF Tanks**

Although diesel fuel and Aftertreatment DEF caps are clearly labeled and filler necks and nozzles are different accidents can happen.

Contamination of fluids by- misfilling of diesel or DEF in the wrong tank may result in vehicle malfunction.

### **Results of misfilling DEF in Diesel Tank**

- Engine may run poorly or not at all
- Injectors may be damaged
- Exhaust system corrosion may occur between turbocharger and Aftertreatment DPF
- On Board Diagnostic (OBD) Diagnostic Trouble Codes (DTC)

- Costly repairs

### **Results of misfilling Diesel in Aftertreatment DEF Tank**





- Aftertreatment SCR system may be damaged by Diesel
- SCR Catalyst may be damaged by diesel (chemical damage)
- Emissions may be non-compliant
- On Board Diagnostic (OBD) Diagnostic Trouble Codes (DTC)
- Costly repairs



# 178 Mack, US10 Emissions Solution

## SCR Tampering - Driver Warning & Inducement

1. Disconnected Aftertreatment DEF tank level sensor	4. Disconnected Aftertreatment DEF pump
2. Blocked Aftertreatment DEF line or dosing unit	5. Disconnected SCR wiring harness
3. Disconnected Aftertreatment DEF dosing unit	6. Disconnected NOx Sensor

Triggers	Aftertreatment DEF Tank Low Level Indicator	Warning Lamp	Inducement
No Tampering	None	None	None
Tampering DTC Pending	None	 <small>W3031623</small>	None
Tampering DTC Confirmed	None	 <small>W3031623</small>	None
Tampering DTC Initial Detected + 10 hour	None	 <small>W3031623</small>	25% torque reduction
Tampering DTC Initial Detected + 40 hours Diesel Fuel Refueling >15%	None	 <small>W3031623</small>	8 km/h (5 mph) road speed limit

**Note:** Operator can not override the 8 km/h 5mph road speed limit.

**Note:** Vehicle has to be stationary before 8 km/h (5 mph RSL) becomes active.

## Warranty and Maintenance

### Exhaust Aftertreatment System Maintenance

The vehicle must be taken to an authorized Mack Truck dealer to remove the ash from the Aftertreatment Diesel Particulate Filter and clean the Aftertreatment Doser.

### Engine Maintenance Intervals

Component		Interval
Fuel Filter	Change	Every oil change. Under certain conditions (for example, irregular fuel quality), the fuel/water separator filters may require more frequent replacement.
Air Cleaner	Change	Control lamp indication or 24 months, whichever comes first
Valve and Injector Lash adjustment , MP7 and MP8	Initial Adjust	200 000 km (125,000 miles) or 12 months, whichever comes first
Injector Lash Adjustment , MP7 and MP8	Adjust	Every 400 000 km (250,000 miles) or 24 months, whichever comes first
Aftertreatment DPF Ash Cleaning	Clean	400 000 km (250,000 miles) or 4,500 hours, whichever occurs first
Aftertreatment Doser	Clean	240 000 km (150,000 miles) or 4,500 hours, whichever occurs first
Aftertreatment Diesel Exhaust Fluid (DEF) Filter	Change	First change at 161 000 km (100,000 miles) 3200 hours or 3 years whichever occurs first, 241,000 km (150,000 miles) 4800 hours or 3 years there after
Aftertreatment Diesel Exhaust Fluid (DEF) Filler Neck Filter	Clean	280 000km (175,000 miles) or 12 months, whichever comes first

## MAINTENANCE INTRODUCTION

Preventive maintenance is vital to the life of your new vehicle. This section of the Operator's Handbook covers items of importance concerning the proper care of MACK vehicles. A well-run maintenance and lubrication program is the best way to ensure a long life of productive operation.

The operator plays an important role in the proper care of this equipment. By performing daily checks and observing the equipment while in operation, minor defects can be caught and corrected before they become major problems. Make sure any problems are corrected before putting the equipment into operation.

If you have any questions concerning the proper care, maintenance and lubrication of your vehicle, or if you need help in developing a preventive maintenance program, contact the service manager at the local MACK Sales, Parts and Service Center.

**Note:** This handbook contains basic maintenance information. For complete maintenance and lubrication procedures, refer to the *Maintenance and Lubrication Manual (21394653)*.

## TURBOCHARGER

The engine turbocharger operates at very high speed, temperatures and pressure. Turbo bearing lubrication is critical, particularly for a newly installed turbo or one which has not been operated for a period of time and all oil has drained from the bearing and shaft surfaces. To avoid turbocharger bearing failure, the following instructions are recommended:

- Start the engine at least every 30 days to ensure turbo bearing lubrication. Operate engine at low idle for at least three minutes before increasing RPM or driving the vehicle.
- If the engine has not been run for more than 30 days, turbo pre-lube procedure is necessary:
  1. Remove turbo air intake duct and oil line connection at turbo.
  2. Fill oil inlet fitting to overflow with clean engine oil.
  3. Using fingers at compressor wheel, carefully spin and wiggle the turbo shaft to distribute the oil over all bearing surfaces.
  4. Reconnect air intake duct and again fill turbo oil port to overflow, connect oil line and start engine.
  5. Operate engine at low idle for at least three minutes before increasing RPM or driving the vehicle.

### CLEANING YOUR VEHICLE

The best protection against environmental influences that can hurt your vehicle's finish is frequent washing and waxing. How often this is required depends on how much the vehicle is used, where it is parked and weather conditions. Frequent washing is required to remove oils, dirt and grime that can stain and oxidize the painted and polished surfaces of your new truck.

#### Exterior Washing

Recommendations for the first 30 days.

- Only wash the vehicle by hand with cool water, a mild car wash solution and a soft cloth or sponge. Do not use a commercial truck wash.
- Wash the vehicle in the shade, never in direct sunlight.
- Do not dry wipe the finish; always use clean water. Dry wiping could scratch the finish.
- Do not park near factories with heavy smoke fallout for extended periods of time.
- Bird droppings have high acid content and can damage freshly painted surfaces. They should be cleaned off as soon as possible.
- Do not spill gasoline, diesel fuel, oil, antifreeze, transmission fluid or any solvents of the like on the new finish. If you do. IMMEDIATELY rinse off with water. DO NOT WIPE.
- Do not scrape ice or snow from surface. Brush off the loose material with a soft snow brush.

Recommendations for the first 90 days.

- Do not wax or polish the vehicle; this will allow the finish to dry and harden completely. (Do not use waxes or polishes that contain silicone.)

**Note:** Do not wash the vehicle in direct sunlight.



#### **DANGER**

*Test the service brakes after washing the vehicle. Moisture and/or ice on the brakes can affect braking efficiency.*

**Note:** When washing the vehicle in cold/freezing weather, avoid direct water spray into the door lock cylinders, as the water may freeze in the lock mechanisms.



## CAUTION

*Proper care of the paint finish is an important part of the durability. Chemicals used to wash the paint should be of neutral pH with a range of between 6 and 8. Detergents containing butyl cellosolve or potassium hydroxide should not be used.*

**Note:** Vehicles should be washed only in special wash bays to protect the environment from cleaning agent contamination.



## DANGER

*Vehicle cleaning products must be handled carefully, as these products may be poisonous. Keep all cleaning products out of the reach of children.*



## WARNING

**Do not clean the underside of the fenders, cab, chassis, etc., without protecting the hands and arms, as injuries may result when scraping against sharp edges.**



## CAUTION

*For chassis used in concrete operations, do not use muriatic acid or similar types of products to clean concrete from the cab or frame surfaces. Use of these types of products will damage the paint finish and void the vehicle warranty. Mack Trucks, Inc. has approved EL-ReadyMix Truck Wash & Wax for removing concrete from the vehicle surfaces. This product is available on a direct ship basis from EMS®. For additional information, contact EMS® at 800-510-8812, or on their web site at [www.enviromfg.com](http://www.enviromfg.com).*

**Note:** Unprotected aluminum surfaces will form an oxide layer if not maintained. This is especially important during cold season when roads are salted or in coastal areas where the salt level in the air is high. Clean with steam or high pressure water. Use a mild detergent if the dirt is heavy. Rinse well. Clean aluminum surfaces with warm water. If the surface has heavy dirt or tar spots, use a tar remover. To prevent spotting, wipe aluminum surfaces dry after washing. The use of an aluminum protective Carnuba-based wax is recommended after washing for longer term protection from road salts and spotting.

## Cab and Hood

- Soften the dirt on your cab with plenty of water and rinse.
- Clean truck with a soft sponge/brush starting at the roof and working downward using slight pressure.
- Use mild detergent. Never use strong soaps or chemical detergents. Any commercially available cleaner designed specifically for automotive finishes may be used for cleaning the cab and hood surfaces. The 3M company and Mequiar's® have a complete line of automotive cleaning products available that are approved for use on MACK vehicles.
- Rinse the sponge or brush often to keep it clean.
- If possible, clean wheels and dirtier areas with a separate sponge/brush. This will help avoid scratching body paint with grit from other areas.
- Rinse truck thoroughly with water and wipe dry with a soft clean chamois or all cotton towels to avoid surface scratches and water spotting.



### CAUTION

*Do not clean the underside of the fenders, cab, chassis, etc. without protecting your hands and arms. You may injure yourself on sharp-edged parts.*

## Chassis

- Wash away excess dirt and grime with water from a hose.
- Use a mild detergent/soap and a soft brush to remove road grime and salts that can collect on the frame.
- Rinse thoroughly with a hose.

**Note:** Cleaning of your chassis on a regular basis will help deter accelerated corrosion and rust on the frame and components. Chemicals used for ice and snow removal and dust control can collect on the frame. If these are not removed in a timely manner, accelerated corrosion can occur on fuel lines, frame, and other components even though they have corrosion protection.

## Cab Interior

- For cleaning vinyl upholstery and lining: wipe with a soft cloth, using a good commercial upholstery cleaner. Do not use acetone, lacquer thinner, etc.
- For cleaning fabric upholstery: use an upholstery shampoo specially designed for this purpose. Follow the directions on the manufacturers label.

## Waxing

- Always use waxes and polishes that are non-abrasive. Do not use waxes or polishes that contain silicone.
- When water does not form small drops and roll off clean paint, apply a coat of good hard wax.
- Even if a liquid wax solution is used on a regular basis, it is advisable to protect the finish with a hard wax at least twice a year.
- Your truck may have a basecoat plus clearcoat. Use a basecoat/clearcoat wax on your paint finish.

## Polishing

Polish your truck only if the paint has lost its shine and the gloss cannot be brought back with wax. It is recommended to have a professional polish your truck to avoid swirl marks or damage to the painted surface. Mequiar's® has a complete line of waxes, polishes and other cleaning and care products that are approved for use on MACK cabs, hoods and sleeper surfaces.

## Winter Warnings

- If you rinse your vehicle with a hose, avoid direct water into lock cylinders. You may experience freezing of the lock mechanism.
- Test brakes after each vehicle wash. Moisture and ice on brakes can affect braking efficiency.

A well kept vehicle can look like new after many years of service. Proper care and maintenance can help you keep your vehicle's beauty and value. You can get an assortment of Mack Trucks approved cleaning products from your local Mack dealer.



# 186 MAINTENANCE AND LUBRICATION

---

## TOWING

Tow pins, hooks, eyes, etc., are located in or behind the front bumper. These devices meet the recommendations for towing set forth by the Technology and Maintenance Council (TMC) of the American Trucking Association and can be used for towing a disabled vehicle from the immediate location.

If it is necessary to remove the tow pin, remove the retainer clip first. Once the retainer clip is pulled, the tow pin can be lifted out of the bumper hole.



### CAUTION

*Do NOT lift and tow any vehicle by tow pins, hooks, eyes, etc. If the vehicle is mired in heavy mud, snow, etc., use a suitable sling-type towing arrangement.*

**Note:** Tow pins, hooks, eyes, etc., are NOT intended for use as long-term towing devices.



### CAUTION

*Failure to disconnect the driveshaft, remove the drive axle shaft(s) or lift the drive wheels off the ground before towing or pushing the vehicle, can cause serious transmission damage.*



### DANGER

*If the drive shaft has been removed for towing, DO NOT reuse bearing retainer bolts or stamped strap bolts, or stamped straps. Reuse of bearing retainer bolts or stamped strap bolts, or stamped straps can cause driveline failure, which can result in separation of the driveline from the vehicle. A separated driveline can result in property damage, serious personal injury or death.*

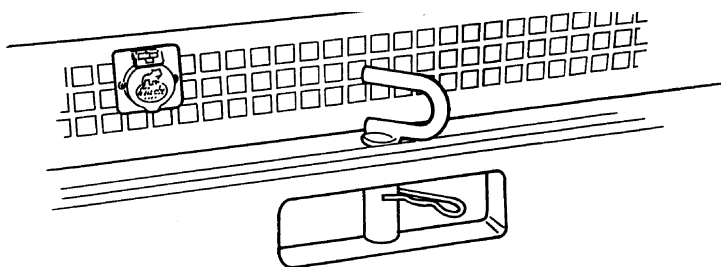

C0029644

## ENGINE OIL LEVEL CHECK

As the operator of this vehicle, it is important for you to perform the daily inspections necessary to keep your truck in good shape. Maintaining the proper oil level in your engine crankcase cannot be overemphasized.

Before checking the oil, remember these important points:

- Measurement of the oil level must be taken on level ground.
- The best time to check oil level is while the engine is COLD (prior to starting at the beginning of the work day, or after the vehicle has sat approximately 2 hours). At normal operating temperature (engine oil temperature above 79.4°C [175°F]), oil level can be checked 15 minutes after shut down.



### CAUTION

*Failure to wait a sufficient amount of time (2 hours if engine oil temperature is below 79.4°C [175°F]) or 15 minutes if oil temperature is above 79.4°C [175°F]) will result in an inaccurate dipstick reading.*

- The level must be close to the FULL line (at least between the ADD and FULL lines) on the dipstick, but must NOT exceed the FULL line (refer to illustration below).

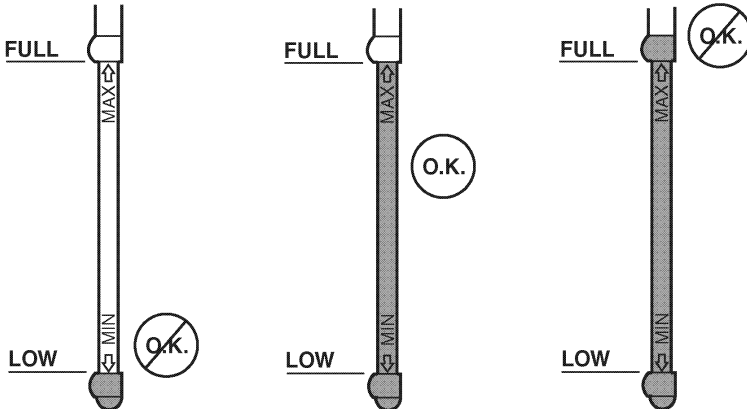

## Power Steering Reservoir

The Power Steering system uses only DEXRON® type automatic transmission fluid.

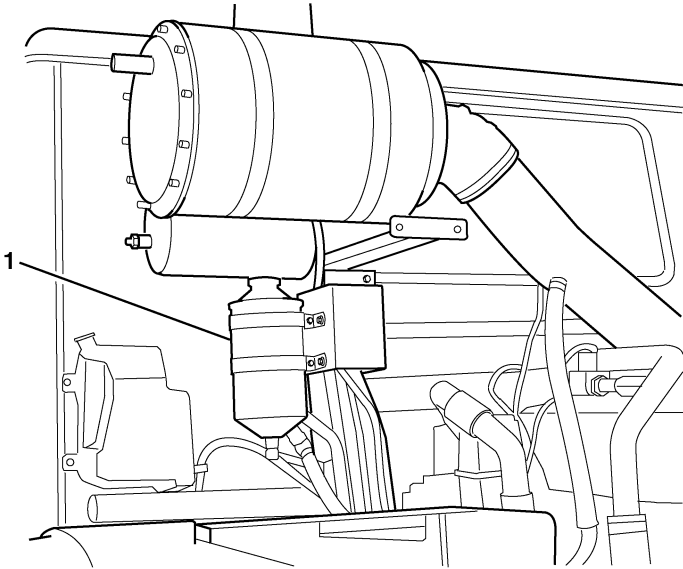

C0029645

### Power Steering Reservoir

1. Power Steering Reservoir
-----------------------------

For additional information about power steering, refer to the *Maintenance and Lubrication Manual (21394653)*.

# 190 MAINTENANCE AND LUBRICATION

---

## FUEL TANK

Your vehicle may be equipped with an isolated fuel tank. If so equipped, the following label will be affixed to the fuel tank decal.

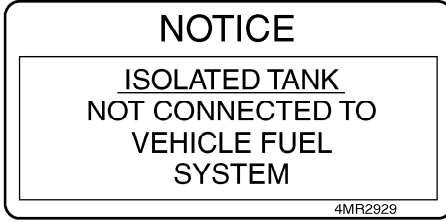

C0029424

## Fuel Tank Cap

Use MACK approved non-vented cap only or tank damage and/or poor engine performance may result. DO NOT fill to more than 95% of liquid capacity.

## FUELING



### DANGER

***DO NOT*** carry extra fuel containers in the cab. Fuel containers, full or empty, may leak, explode or give added fuel to a fire. Failure to follow this precaution may lead to serious personal injury or death.



### DANGER

***DO NOT*** smoke while fueling the vehicle. The glow from the cigar/cigarette can ignite the diesel fuel, causing an explosion resulting in serious personal injury or death.



### DANGER

***Do not*** remove the fuel tank cap near an open flame. Diesel fuel vapors are combustible and can cause an explosion or fire, resulting in severe personal injury or death.



### CAUTION

*Diesel-powered engines for heavy-duty trucks built on or after January 1, 2010 are designed to operate only with Ultra Low Sulfur Diesel (ULSD) fuel. Improper fuel use will reduce the efficiency and durability of engines, permanently damage advanced emissions control systems, reduce fuel economy and possibly prevent the vehicles from running at all. Manufacturer warranties will be voided by improper fuel use. Additionally, burning Low Sulfur Diesel fuel (instead of ULSD fuel) in 2007 and later model year diesel-powered cars, trucks and buses is illegal and punishable with civil penalties.*



## CAUTION

*Ultra Low Sulfur Diesel (ULSD) fuel with a maximum sulfur content of 15 ppm must be used in order to meet Euro4 engine emission requirements. Using otherwise approved diesel fuels with a maximum sulfur content greater than 500 ppm may shorten engine life and void the engine warranty.*

Air is always present inside the fuel tanks, entering mainly through the tank ventilation. With the air being heated and cooled, condensation is formed and water is mixed in the fuel. To avoid condensation when the vehicle is parked for longer periods, fill the tanks up to 95% of capacity. Do not fill more than that, as the fuel needs to have room for expansion during the heat of the day.

## BioDiesel

Soy Methyl Ester (SME or SOME) BioDiesel fuel in blends up to a B5 concentration (5% blend) is approved by Mack Trucks, Inc.

**Note:** Although higher concentrations are available, concentrations up to B5 (maximum) are the only blends currently approved by Mack Trucks, Inc.

**Note:** MACK Engines are certified to comply with U.S. EPA and California Air Resources Board (CARB) emissions standards based on the use of reference test fuels commonly available in the United States and specified in this manual. Use of alternative fuels, including BioDiesel, may affect engine emissions. Mack Trucks, Inc. does not warrant, and is not responsible for ensuring that the engines will comply with U.S. EPA and CARB emissions standards.

## B5 Approval For MACK US 2010 Certified Products

Mack engines are certified to comply with U.S. EPA and California emissions standards based upon the use of test fuels with specifications established by these regulatory agencies. Alternative fuels, including biodiesel, that are not substantially similar to the required test fuels may adversely affect engine emissions compliance and may impact the performance of certain emissions aftertreatment components. As a result, Mack does not warrant the engine will conform to applicable Federal or California emissions limits when operated on, or having operated on, biodiesel or other alternative fuels that are not substantially similar to specified test fuels used for certification.

The use of biodiesel up to a maximum of 20% (B20) in and of itself, will not affect the manufacturers mechanical warranty as to engine or emissions system related components except as limited below with respect to aftertreatment components, provided the bio fuel used in the blend conforms to ASTM D6751, and B1 to B5

blends conform to ASTM D975, and B6 to B20 blends conform to ASTM D7467. Failures of certain emissions aftertreatment components, specifically SCR, DPF and NOx sensors will not be warranted if the failure can be attributed to operation on biodiesel blends from 6 to 20% (B6 to B20) even if the biofuel used in the blend B6 to B20 conforms to ASTM D7467 or any related standard.



# 194 MAINTENANCE AND LUBRICATION

---

## COOLING SYSTEM

The cooling system is a pressurized system. The coolant is circulated by a centrifugal pump. It is a typical system in most respects, but there are a few things to keep in mind when checking or working on the cooling system.

**Note:** There is an auxiliary radiator located behind the cab that includes electrically operated fans. The fans may begin to run at any time without warning. Keep clear of fans.



### WARNING

**Keep clear of fan when engine is running. Fan may start to rotate at high speed without warning.**



### WARNING

**Avoid injury when checking coolant in a hot engine. Wait for the engine to cool prior to checking the level whenever possible.**

## Coolant Level Check



### WARNING

**Turn the cooling system pressure cap counterclockwise to the first stop but do NOT depress. After the pressure has completely dissipated, press the cap downward and continue turning to remove.**

Your MACK model chassis has a pressurized surge tank located on the left-hand side of the chassis, mounted on the air cleaner assembly support bracket. Coolant should be visible in the sight glass (see arrow in illustration) located on the side of the tank.

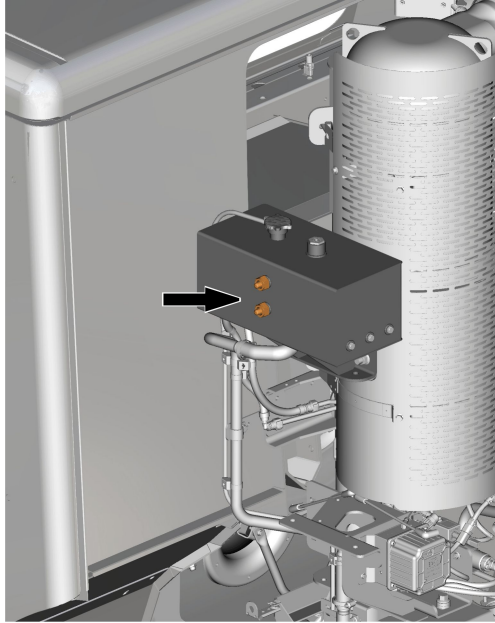

W2056638

## Draining the Cooling System

Whenever repairs are to be made which would require disconnection of coolant hoses, etc., the cooling system should be drained. Carefully remove the filler cap and remove all pipe plugs.

## Refilling the Cooling System

Close all drain cocks and fill with the proper coolant mixture. Run engine with the pressure cap removed until operating temperature is reached and the thermostat opens. Recheck level and add coolant if required. Run the engine long enough to be sure the system is free of air and has the correct amount of coolant.

## Protecting the Cooling System



### CAUTION

*The concentration of ethylene glycol or propylene glycol in the cooling system must be checked with a refractometer prior to traveling or operating in areas where subfreezing temperatures may be encountered. When adding antifreeze to the system, run the engine for 20 minutes before checking with a refractometer.*

**Note:** Your chassis is currently supplied from the factory with engine coolant protection to  $-23^{\circ}\text{C}$  ( $-10^{\circ}\text{F}$ ). Optional coolant protection to  $-40^{\circ}\text{C}$  ( $-40^{\circ}\text{F}$ ) is also available.

Ethylene glycol or propylene glycol-based antifreezes are both approved for all MACK engines. All ethylene glycol and propylene glycol coolants must be low-silicate antifreezes which meet ASTM4985 test (GM6038M SPEC) criteria. These antifreezes are sometimes referred to as heavy-duty diesel coolants. Passenger car coolants do NOT meet this specification.

Be sure to maintain the required level of antifreeze protection for anticipated winter temperatures in your area of operation. A 40% to 60% concentration of antifreeze is required for MP engines, regardless of application, geographic location or ambient air temperature.



### CAUTION

*Do NOT exceed a 60% concentration of antifreeze to water. A higher percentage of antifreeze will not increase protection. Concentrations over 60% adversely affect freeze protection and heat transfer rates.*

**Note:** Propylene glycol should be checked with a refractometer.

**Note:** ALWAYS mix the water/antifreeze solution before pouring it into the cooling system.

**Note:** The piping arrangement may cause capacity variation depending on the type of cooling system and optional external cooling devices which may be attached. Therefore, it is difficult to tell exactly how much coolant it will take to fill any one particular system.



## CAUTION

*Do NOT use coolant solutions which contain anti-leak additives in trucks equipped with coolant filters or conditioners.*



## CAUTION

*Do NOT use soluble oil-type coolants in any MACK cooling system.*

## Cooling System Maintenance

The cooling system must be maintained by performing regularly scheduled maintenance as outlined in the Maintenance and Lubrication Manual (21394653). Cold weather operations, however, place added demands on the cooling system. Prevent potential cold weather problems by performing a quick check of the cooling system as outlined below:

- Make a general check for cooling system leaks.
- Inspect hoses and clamps for leaks and condition. Tighten hose clamps to specifications (as required).
- Check coolant level. Add fresh coolant (in specified concentration) as necessary.
- Check and record degree of antifreeze concentration. Add antifreeze as necessary to obtain required protection level.

For additional information concerning the cooling system, refer to the *Maintenance and Lubrication Manual (21394653)*.

## Accessory Drive Belt Routing

The following diagram shows the accessory drive belt and main belt routing with and without air conditioning. This diagram is located in a clear area on the outside of the left frame between the radiator and center line of the front axle.

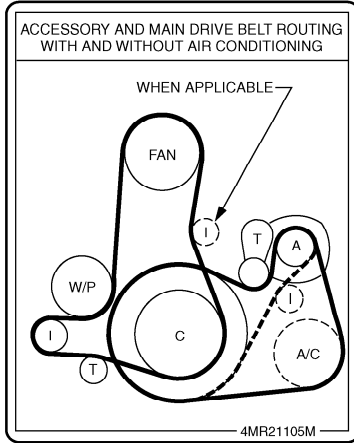

1

C0029647

### Accessory and Main Drive Belt Routing

1. Accessory and Main Drive Belt Routing MP7 Engine

## HEADLIGHTS

### Bulb Replacement

**Note:** This vehicle uses a sealed beam type headlamp bulb which is not replaceable without special tools. This vehicle should be taken to a qualified Mack Trucks dealer for replacement.

## WHEELS

### Wheel Inspection

Look at the wheels and cap nuts. Inspect them for evidence of cap nut looseness. Rust streaks from the cap nut ball seat are an indication of looseness. Refer to the Maintenance and Lubrication Manual (21394653) for complete procedures concerning wheel inspection and wheel nut tightening.

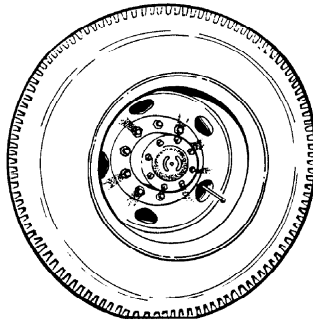

C0029431

Look for cracks around the hand hole, stud hole and wheel. Look for broken studs, wheel damage or improperly seated lock rings.

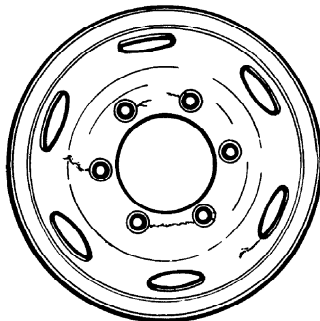

C0029432

### Tires



#### DANGER

*Tires used on multipiece rims must be assembled and inflated only by experienced, qualified personnel. Tires must be inflated in a safety cage whenever possible. If, however, a safety cage is not available, use a portable lock-ring guard. The tire must be deflated prior to removal of the tire-and-rim assembly from the vehicle. Remove the valve core to ensure complete deflation.*



#### DANGER

*NEVER position your body in front of the rim during inflation.*



#### CAUTION

*NEVER use water-based sealants, puncture proofing, or liquid balance materials containing water in All-Steel Radial Ply truck tires.*

#### ***Inflation Pressure***

To ensure maximum mileage and overall performance from your tires, it is essential that they operate at the correct inflation pressure for the load carried. Inflation pressure should be checked daily while the tires are cold. Always use an accurate tire pressure gauge. NEVER bleed air from a hot tire, as it will then be underinflated. Refer to the specific tire manufacturers data books, or to the vehicle certification label for a complete listing of tire inflation pressures. For additional information concerning tire care, refer to the *Maintenance and Lubrication Manual (21394653)*.



#### WARNING

**UNDER NO CIRCUMSTANCES** should you drive on underinflated or overloaded tires. A tire in this condition builds up excessive heat which can result in sudden tire destruction, property damage and personal injury.



## CAUTION

*Never bleed air from your tires in an attempt to gain traction for a vehicle stuck in snow, ice or mud. This practice provides no additional traction and typically results in underinflated tires. Never bleed air from a hot tire since that tire will then be underinflated.*

To adjust for pressure fluctuations induced by temperature changes associated with winter weather, it is recommended that tire inflation pressure be checked daily when the tires are cold (i.e., before the vehicle is driven). Always use an accurate tire pressure gauge.

### **Inspection**

Inspect your tires daily. Look for bulges, cracks, cuts, penetrations and/or oil contamination. If any such damage is found, the tire must be thoroughly inspected by a qualified tire inspector and repaired or discarded immediately, at his discretion. Also, check for uneven wear. If found, a thorough inspection of front end parts and alignment should be made by a qualified mechanic. Refer to the Maintenance and Lubrication Manual (21394653) for more information.

### **Tire Manufacturers Data Book**

Specific and more detailed information can be obtained by referring to the technical data books provided by each tire manufacturer.

Subjects of interest are:

- High-speed or low-speed operation
- Repair, retreading and regrooving
- Use of tire chains
- Mixing radial and bias tires on the same vehicle
- Use of dynamometers
- Tire mounting/dismounting





### CAUTION

*For important tire information (i.e., high speed limits, inflation pressures, etc.), consult the product information available through the specific tire manufacturer.*

### ***Oil Contamination of Tires***

Lubricating oils, fuel oil, gasoline and other petroleum derivatives, if allowed to contact tires, will soften the rubber and destroy the tire. Preventive maintenance is necessary to ensure that oil leakage does not occur. The following areas should be inspected on a regular basis:

- Axle end seals
- Engine seals
- Transmission seals
- Drive axle seals
- Oil filters
- Oil and hydraulic lines (if equipped)
- Refer to the *Maintenance and Lubrication Manual (21394653)*, specific tire manufacturers books, or to the vehicle certification label, for additional information concerning tires and their care.

## BATTERY



### CAUTION

*To avoid damage to sensitive electronic equipment, disconnect ALL battery cables and harnesses to electronic control units before welding. Do NOT disconnect batteries while engine is running.*

## Jump-Starting Engine

If you encounter a situation in which it is necessary to jump-start an engine, use the following procedures.



### WARNING

**Batteries which are to be linked together must be of the same voltage (12 to 12, 24 to 24). Take care to observe proper polarity when connecting batteries. Batteries produce explosive gases. Keep sparks, flames, cigarettes, etc., away from batteries at all times. Protect your eyes by wearing safety goggles. Be sure vehicles are NOT touching each other.**



### CAUTION

*To avoid damaging any electronic controllers when jump-starting a V-MAC vehicle, always turn the ignition switch OFF before connecting the batteries.*

1. Connect the positive (+) cable to positive (+) post of discharged battery or to the positive post of the remote jump-start connector (if equipped).
2. Connect the other end of the same cable to the positive (+) post of the booster battery.
3. Connect the second cable, negative (-) side, to the other post of the booster battery.
4. Make the final connection to the negative (-) battery terminal or the remote jump-start connector (if equipped) of the stalled vehicle, and stand back.

## 204 MAINTENANCE AND LUBRICATION

---

5. Start the vehicle with the booster batteries and then start the stalled vehicle. Shut down the vehicle with the booster batteries and remove the cables in the reverse order of connection.



### WARNING

**Do NOT connect the final negative (-) connection to the frame of the stalled vehicle. This would cause all current to flow through the master ground circuit breaker resulting in overload.**

## ELECTRICAL

### Circuit Breaker and Relay Panels

The electrical equipment cover for this vehicle is located under the dash on the left-hand side of the cab. The label for this panel may be located under the driver left side operating position, behind the access panel. You need to remove the panel in order to view this label.

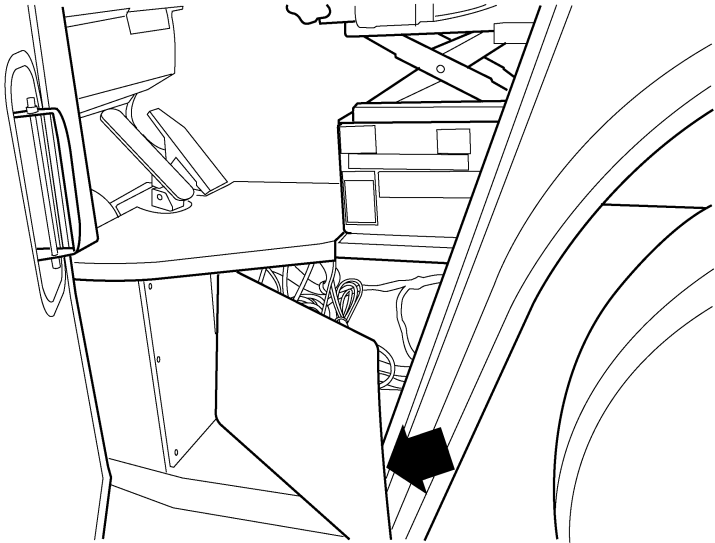

C0029648

The cover panels are fastened with screws. Most relays and fuses are accessible from under the top cover. Since the function of some fuses or relays may change for the vehicle operation, refer to the list of functions that is attached beneath each panel.



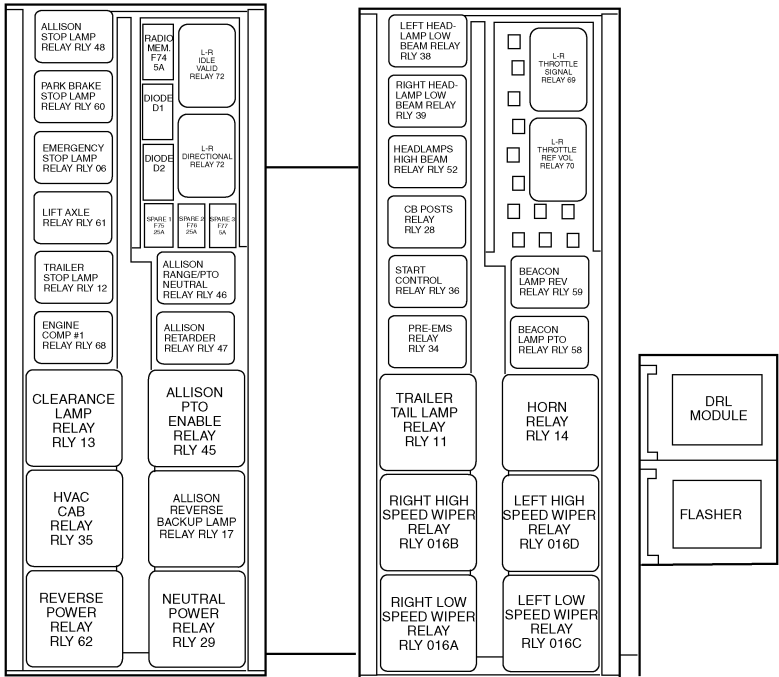

C0029650

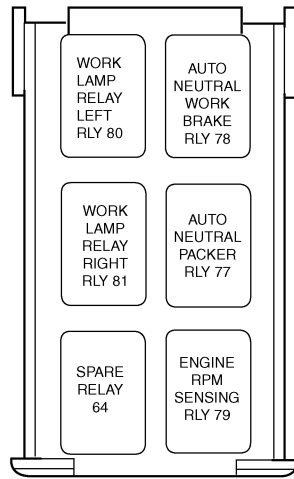
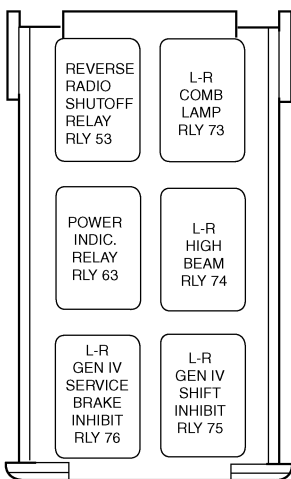

C0029651

**Note:** For circuit breaker designations, refer to the Circuit Protection charts.

Fuses are standard equipment for all circuits except the headlamps and windshield wipers. Circuit breakers are available as optional equipment.



### CAUTION

*For proper installation of electrical accessories, all wiring should meet SAE requirements and be routed through the circuit protection panel with proper amperage fuses or Type II circuit breakers. (Headlights and wipers will be on Type I, cycling-type circuit breakers.)*

Some vehicles may be equipped with daytime running lights. For the daytime running lights to be operational, a DRL module must be installed in the relay socket marked either DRL MOD or Running Lamps on the electrical equipment panel. Do NOT install a standard relay into the daytime running light relay socket (marked either DRL MOD or Running Lamps) or a short circuit in the headlight high beam circuit will result.

The headlight circuits are protected by SAE Type I (automatic reset-cycling) circuit breakers that automatically interrupt then restore the flow of current through the circuit in the event of an overload. This cycling will continue until the cause of the overload is repaired.

SAE Type II (automatic reset, non-cycling) circuit breakers (if equipped) provide a complete circuit disconnect until the overload is corrected. The power to the affected circuit breaker must be shut off before the circuit breaker will reset itself.

The circuit protection panel also provides access to battery, ignition and ground terminals for non-factory installed electronic equipment. (On V-MAC chassis, there are two serial link terminals for easy local connection of a trip recording device.)

## Electrical Grease

To prevent corrosion of the lamp socket terminals, particularly with the clearance and marker lamp, apply a coating of electrical sealing grease, such as Lubriplate DS-ES or TEK-519, to the socket and terminal assemblies.



### CAUTION

*Do not use electrical grease on any V-MAC connectors.*



## 210 MAINTENANCE AND LUBRICATION

### Circuit Protection Charts

<b>Cab Circuit Protection (V-MAC IV)</b>			
CB2 — 15	CB3 — 15	CB4 — 20A	F5 — 10A
Headlamps Hi Beam	Park & Tail Lps.	Turn Signals Flasher	Tractor Emergency Stop Lps.
F6 — 10A	F7 — 10A	F8 — 15A	F9 — 15A
Dome Lps. Courtesy Lps.	Key Switch	Air Sol.	CB Posts
F10 — 5A	F11 — 15A	F12 — 15A	F13 — 15A/20A
Diag. Conn.	Battery Stud	Battery Stud	ABS Battery
F14 — 30A	F15 — 15A	F16 — 10A	F17 — 10A
Aux. Fan Cool	Beacon Lamps	VECU EMS Power	VECU Ctrl. Sw. Input
F18 — 10A	F19 — 5A	F20 — 10A	CB21 — 20A
DCL EMS Power	Instrument Cluster Battery	Moto Mirrors	LH Windshield Wiper & Washer
CB22 — 20A	CB23 — 10A	F24 — 15A	F25 — 30A
RH Windshield Wiper & Washer	WS Wiper/Washer	2 Way Radio Opt.	HVAC Cab Unit
F26 — 15A	F27 — 15A	F29 — 10A	F30 — 10A
Rear Flood	Ignition Stud	EMS Relay	Munc. PTO Opt. Ign.
F31 — 10A	F32 — 15A	F33 — 20A	F34 — 30A
Trans. Ign.	Body Builder Battery 2	Trailer Stop Lps.	Reverse/Neutral Power
F35 — 25A	F36 — 15A	F37 — 25A	F38 — 30A
Clearance Lamps	Horn	Tail Lamp	Engine Ctrl. Unit

# MAINTENANCE AND LUBRICATION 211

<b>Cab Circuit Protection (V-MAC IV)</b>			
F39 — 30A	F40 — 25A	F41 — 15A	F42 — 10A
Trailer ABS Power	Body Ignition Stud	Engine Acc.	Back-Up Lamp
F43 — 15A	F44 — 20A	F45 — 30A	F46 — 10A
Eng. Comp #2	Heat/Air Dryer	Fuel Heater	Power Outlet
F47 — 15A	F49 — 10A	F50 — 10A	F51 — 10A
Spare EMS	ABS Ignition	Head Lamp Left	Head Lamp Right Low B
F52 — 15A	F54 — 20A	F55 — 20A	F56 — 10A
Spare Brake Wear	DPF Battery	Heated Mirror	Telma
F57 — 15A	F58 — 5A	F60 — 15A	F61 — 20A
HVAC Roof Unit	L-R Relay Ctrl.	Engine Comp #1	Body Battery Stud
F62 — 30A	F63 — 5A	F64 — 10A	F65
Aux. Fan Cool Package	Instrument Cluster (EMS)	DPF Ignition	Open
F66 — 15A	F67	F68 — 15A	F69
Spare Ign.	Open	Cigar Lighter	Open
F71 — 10A	F74 — 5A	F75 — 25A	F76 — 25A
Trans. Battery	Radio Mem.	Spare	Spare
F77 — 5A			
Spare			

## 212 METRIC CONVERSIONS

---

### METRIC CONVERSIONS

**Note:** Use all tools on the fasteners they were made to be used on. Use metric tools on SI metric units only. Never try to use metric tools on U.S. standard fasteners or U.S. standard tools on SI metric units.



#### CAUTION

*Potential external/internal thread mismatch condition(s) may occur with certain metric thread-inch thread fastener combinations, and with fastener combinations involving incompatible metric fastener systems. A given thread mismatch condition can result in thread stripping and/or assembly weakness leading to potential service failure, thereby rendering a vehicle non-operational and/or unsafe for operation. The specific external/internal thread combinations from which such problems can result are identified and set forth in Maintenance and Lubrication Manual (21394653).*

<b>SI to U.S. Conversions</b>		
25.4 millimeters	=	1 inch
1.61 kilometers	=	1 mile
.473 liter	=	1 pint (U.S. liquid)
.946 liter	=	1 quart (U.S. liquid)
.01639 liter	=	1 cubic inch
1.3558 Newton meters	=	1 pound-foot
.746 kilowatt	=	1 horsepower
6.895 kilopascals	=	1 pound/square inch
(1.8 x degrees Celsius) + 32	=	degrees Fahrenheit
.83267 Imperial gallon	=	1 gallon (U.S. liquid)
<b>U.S. to SI Conversions</b>		
.03937 inch	=	1 millimeter
.6214 mile	=	1 kilometer
2.1134 pints (U.S. liquid)	=	1 liter
1.0567 quarts (U.S. liquid)	=	1 liter
61.024 cubic inches	=	1 liter
.7376 pound-foot	=	1 Newton meter
1.34 horsepower	=	1 kilowatt
.145 pound/square inch	=	1 kilopascal
.556 x (degrees Fahrenheit -32)	=	degrees Celsius
1.2009 gallons (U.S. liquid)	=	1 Imperial gallon

