

MODEL
587

OWNER'S MANUAL



A **PACCAR** COMPANY

Quick Table of Contents

Introduction	1
Cab And Frame Access	6
Getting To Your Engine	11
Controls And Displays.	14
Seat And Restraint Systems	75
Driver's Checklists	88
Starting And Operating The Vehicle	93
Maintenance and Service	143
Vehicle Identification	229
Consumer Information	230
Subject Index	233

© 2010 PACCAR INC - All Rights Reserved

This manual illustrates and describes the operation of features or equipment which may be either standard or optional on this vehicle. This manual may also include a description of features and equipment which are no longer available or were not ordered on this vehicle. Please disregard any illustrations or descriptions relating to the features or equipment which are not on this vehicle.

Peterbilt reserves the right to discontinue, change specifications, or change the desing of its vehicles at any time without notice and without incurring any obligation.

The information contained in this manual is propietaary to Peterbilt. Reproduction, in whole or in part, by any means is strictly prohibited without prio written authorication from PACCAR Inc.

PART 1: INTRODUCTION

This manual contains useful information for the safe and efficient operation of your Peterbilt Model 587. It also provides information on maintaining your vehicle in the best condition, with an outline for performing safety checks and basic preventive maintenance inspections.

We have tried to present the information you'll need to learn about your vehicle's functions, controls, and operation—and to present it as clearly as possible. We hope you'll find this manual easy to use.

Please remember, though—this manual is not a training manual. It can't tell you everything you need to know about driving your Peterbilt vehicle. For that you need a good training program or truck driving school. If you have not been trained, get the proper training before you drive. Only qualified drivers should drive this vehicle.

There will be times when you need to take this manual out of your Peterbilt. When you do, please be sure to return it to the cab when you are finished using it. That way it will be there when you need it the next time or when you pass the vehicle on to the next user.

How To Find What You Want

There are several tools built into this manual to help you find what you need quickly and easily.

First is the **Quick Table of Contents**. Located at the front of the manual, this lists the main subjects covered and gives page numbers where you can find these subjects. Use the Quick Table of Contents to find information on a large subject like "Maintenance."

Cross-referenced citations also help you get the information you need. If some other part of the manual contains further information on the subject you are reading about, we'll indicate that in a cross-reference like this: (See ["PART 6: DRIVER'S CHECKLIST"](#)). You won't have to go searching for more information.

Finally you'll find a helpful **Subject Index**. It's in the back of the manual and alphabetically lists the subjects covered. So if you want information on brakes, for example, just look under Brake in the Subject Index. You'll find all the pages listed where brakes or braking are discussed.

A Special Word About Repairs

Your Peterbilt dealer's service center is the best place to have your vehicle repaired. You can find Peterbilt dealers all over the country with the equipment and trained personnel to get you back on the road quickly—and keep you there.

Your vehicle is a complex machine. Anyone attempting repairs on it needs good mechanical training and the proper tools. If you are sure you have these requirements, then you can probably perform some repairs yourself. However, all warranty repairs must be performed by an authorized Peterbilt service facility. If you aren't an experienced mechanic, or don't have the right equipment, please leave all repairs to an authorized service facility. They are the ones equipped to do the job safely and correctly.



WARNING! Attempting repair work without sufficient training, service manuals, and the proper tools can be dangerous for yourself and others. You could be injured or you could make your truck unsafe and cause death or serious injury. Do only those tasks you are fully qualified to do.

Maintenance Manuals. If you do decide to do any complex repair work, you'll need the Peterbilt Maintenance manuals. Order them from your authorized dealer. Please provide your Chassis Serial Number when you order, to be sure you get the correct manuals for your vehicle. Allow about four weeks for delivery. There will be a charge for these manuals.

Final Chassis Bill of Material. A complete, nonillustrated computer printout listing of the parts used to custom-build your Peterbilt vehicle is available through the Peterbilt dealer from whom you purchased your vehicle.



WARNING! Modifying your vehicle can make it unsafe. Some modifications can affect your truck's electrical system, stability, or other important functions. Before modifying your vehicle, check with your dealer to make sure it can be done safely.

Additional Sources of Information

Operator's manuals are also supplied by the manufacturers of components such as the engine, seats, transmission, and radio in your Peterbilt. If you are missing any of these manuals, ask your Peterbilt dealer to supply them.

Another place to learn more about trucking is a local truck driving school. Contact one near you to find out what kinds of instruction it offers.

Federal agencies such as The National Highway Traffic Safety Administration and the Federal Motor Carrier Safety Administration also have information and various agencies in state governments are sources for regulations that differ from state to state.

Safety Signals

A number of alerting messages are in this manual. Please read and follow them. They are there for your protection and information. These messages can help you avoid injury to yourself and others, as well as prevent costly damages to the vehicle.

Key symbols and “signal words” are used to indicate what kind of message is going to follow. Pay special attention to instructions prefaced by symbols and the signal words “WARNING”, “CAUTION”, and “NOTE”. Please do not ignore any of these alerts.

WARNING



When you see this word, the message that follows is especially vital. It signals a **potentially hazardous situation** which, if not avoided, could result in an injury or death. This message will tell you what the hazard is, what can happen if you don't heed the warning, and how to avoid it.

Example:



WARNING! Never carry additional fuel containers in the vehicle. Such containers, full or empty, may leak, explode or cause a fire in the event of a collision.

CAUTION



Signals a **potentially hazardous situation** which, if not avoided, could result in property or vehicle damage.

Example:



CAUTION: Continuing to operate your vehicle with insufficient oil pressure will cause serious engine damage.

NOTE

Provides general information: for example, the note may suggest how to operate the vehicle more efficiently.

Example:



NOTE: Pumping the accelerator will not assist in starting the engine.

Please take the time to read these messages when you see them, and remember:

WARNING!

Something that could seriously injure or kill you or others.

CAUTION:

Something that could cause property or vehicle damage.

NOTE:

Useful information.

Vehicle Safety

Make sure your Peterbilt is in top working condition before heading out on the road—it is the *responsible* driver's duty to do so. Inspect the vehicle according to [“PART 6: DRIVER'S CHECKLIST”](#).



WARNING! Do not drink and drive. Your reflexes, perceptions, and judgment can be affected by even a small amount of alcohol. You could have a serious—or even fatal accident—if you drive after drinking. Please do not drink and drive or ride with a driver who has been drinking.



WARNING! The use of alcohol, drugs, and certain medications will seriously impair perception, reactions, and driving ability. These circumstances can substantially increase the risk of an accident and death or personal injury.

Please remember, this manual is not a training manual. It cannot tell you everything you need to know about driving your Peterbilt vehicle. For that you need a good training

program or truck driving school. If you have not been trained, get the proper training before you drive. Only qualified drivers should drive this vehicle.

Safe driving is only possible with the proper concentration on the driving task. Keep distraction to a minimum to improve your concentration. Examples of distractions may include radio controls, GPS navigation controls, cellular telephone calls, cellular text messages, reading or reaching for something on the floor. Minimizing your distractions will improve safe driving and will help avoid an accident involving death or personal injury.

Be aware of local regulations that may prohibit the use of cellular telephones while driving. In addition to being an unsafe practice, it may be against local ordinances to use cellular devices while operating the vehicle.

Every new Peterbilt vehicle is designed to conform to all Federal Motor Vehicle Safety Standards applicable at the time of manufacture. However, even with these safety features, continued safe and reliable operation depends greatly upon regular vehicle maintenance. The vehicle must be operated within the range of its mechanical capabilities and the limits of its load ratings. (See the Tire and Rim Weight Ratings label on the driver's door edge.)

PART 2: GETTING INTO & OUT OF THE CAB AND FRAME ACCESS

Be careful whenever you get into or out of your vehicle's cab. Always maintain at least three points of contact with your hands on the grab handles and your feet on the steps.



WARNING! Do not jump out of the cab or get into the cab without proper caution. You could slip or fall, possibly suffering death or serious injury. You could slip and fall if the steps are wet or icy, or if you step in fuel, oil, grease, snow or mud.

The illustrations that follow show the best ways to enter and exit a cab.

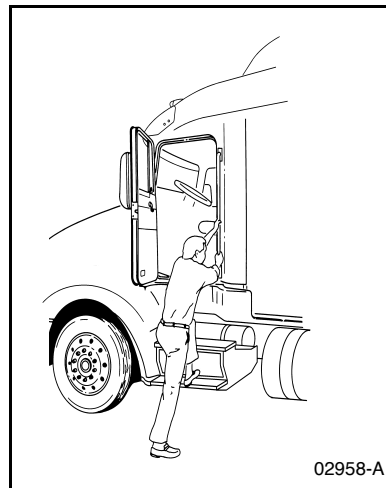

02958-A

Vehicle With External Grab Handle

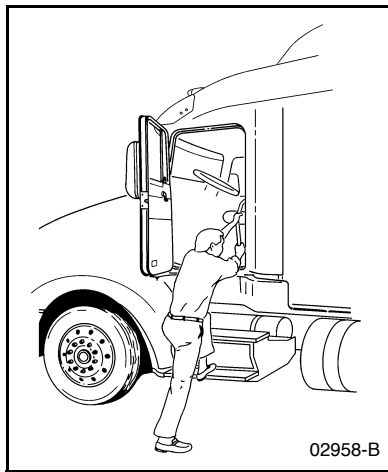

Vehicle Without External Grab Handle

Door Lock and Keys

Doors can be locked from the inside by using the lock button. Close the door then push the button down to lock. Doors automatically unlock when you open them from inside, and can be locked from the outside with the key only. To lock or unlock the doors from outside the cab, insert the key in the lock. Turn the key toward the rear to lock; forward to unlock.



WARNING! To help lessen the chance and/or severity of death or personal injury in case of an accident, always lock the doors while driving. Along with using the lap shoulder belts properly, locking the doors helps prevent doors from inadvertently opening and occupants from being ejected from the vehicle.

Remote Keyless Entry (optional)

This vehicle may be equipped with a Remote Keyless Entry (RKE) system that adds security and convenience to your vehicle. The system will lock or unlock the driver's door and passenger's door with the key fob and alert you with parking lights when the selected door's are locked or unlocked. The system includes two key fobs that provide secure rolling code technology that prevents someone from recording the entry signal.

Operation

To unlock the driver's door, press the UNLOCK button once. The driver's door will unlock and the parking lights will come on for 40 seconds.

To unlock the passenger's door press the UNLOCK button once and press again within 5 seconds.

To lock both doors press the LOCK button. The doors will lock and the parking lights will come on for 2 seconds. If the doors are open they will not lock. The range of the RKE system should be approximately 30 ft. This will be reduced if it is operated close to other RF sources such as TV/radio transmitters and cell towers.

Batteries

The key fob uses one CR2032, 3V battery. Batteries should last approximately three years, depending on use. Consistently reduced range is an indicator that the battery needs replacement. Batteries are available at most discount, hardware and drug stores.

The battery is located under the back cover of the key fob. Be sure to synchronize the key fob every time you replace the batteries.

Synchronization

The key fob may need to be synchronized to the truck when the battery is replaced or when the key fob has not been used for an extended period time.

To Synchronize A Key Fob

1. Hold the key fob near the receiver.



NOTE: The receiver is located behind the Speedometer/Tachometer cluster assembly.

2. Press and hold both the Lock and Unlock buttons at the same time for approximately 7 seconds.
3. When the key fob is resynchronized, the doors will lock then immediately unlock.
4. If the fob fails to synchronize, it could be programmed to a different truck or could have failed. Contact your dealer to re-program your key fob.

FCC ID: L2C0031T IC: 3432A-0031T

FCC ID: L2C0032R IC: 3432A-0032R

This device complies with Part 15 of the FCC Rules and with RSS-210 of Industry Canada. Operation is subject to the following two conditions:

1. This device may not cause harmful interference, and
2. This device must accept any interference received, including interference that may cause undesired operation.



WARNING: Changes or modifications not expressly approved by the party responsible for compliance could void the user's authority to operate the equipment. The term "IC:" before the radio certification number only signifies that Industry Canada technical specifications were met.

Climbing Onto the Deck Plate

When you are climbing onto and off the deck plate, maintain at least three points of contact with your hands on the grab handles and your feet on the steps.



NOTE: Any alteration (adding bulkheads, headache racks, tool boxes, etc.) behind the cab or sleeper that affects the utilization of grab handles, deck plates, or frame access steps installed by Peterbilt must comply with FMCSR 399.



WARNING! Do not step on vehicle components without antiskid surfaces or use components not designed for entry-and-exit use. You could fall and kill or injure yourself if you step onto a slippery surface. For example:

- Do not step onto the surface of a fuel tank. A fuel tank is not a step. The tank surface can get very slippery, and you might not be able to prevent a fall.
- Use only the steps and handholds provided, not chain hooks, quarter fenders, etc.
- Do not climb onto and off the deck plate—use steps and grab handle provided. If there is no deck plate, or if proper steps and grab handles are not provided, do not climb onto the area behind the cab.
- Do not climb onto or stand on the frame rails. The frame rails are very slippery and could cause you to fall, resulting in death or personal injury.
- Always reinstall steps before entering the cab or accessing the deck plate. Without steps, you could slip and fall, resulting in possible injury to yourself.



Hold handles as you step up

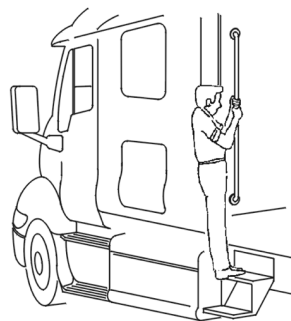

Three points of contact as you reach the deck area

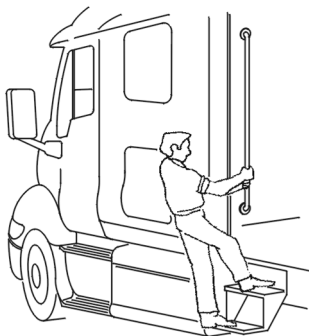

Three points of contact

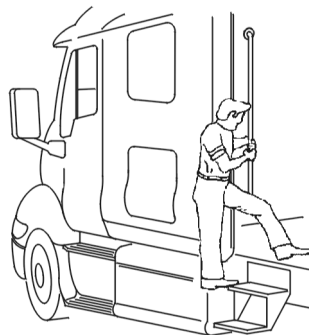

Three points of contact as you step to the deckplate

PART 3: GETTING TO YOUR ENGINE

Hood Hold Downs

Hood hold downs keep a hood from opening unexpectedly.



CAUTION: A hood not latched securely could open during operation and cause vehicle damage. Be sure to latch the hood securely.

Hood Tilt

Follow this procedure to tilt the hood.



WARNING! A pivoting hood could hurt someone or be damaged itself. Before opening or closing the hood, be sure there are no people or objects in the way. Failure to stand in a position of safety can cause death or personal injury.

1. To open your hood, unlock the hood hold downs by unlatching them. Put one hand on the top of the hood front, one foot on the bumper, and one foot on the ground. Tilt the hood forward.

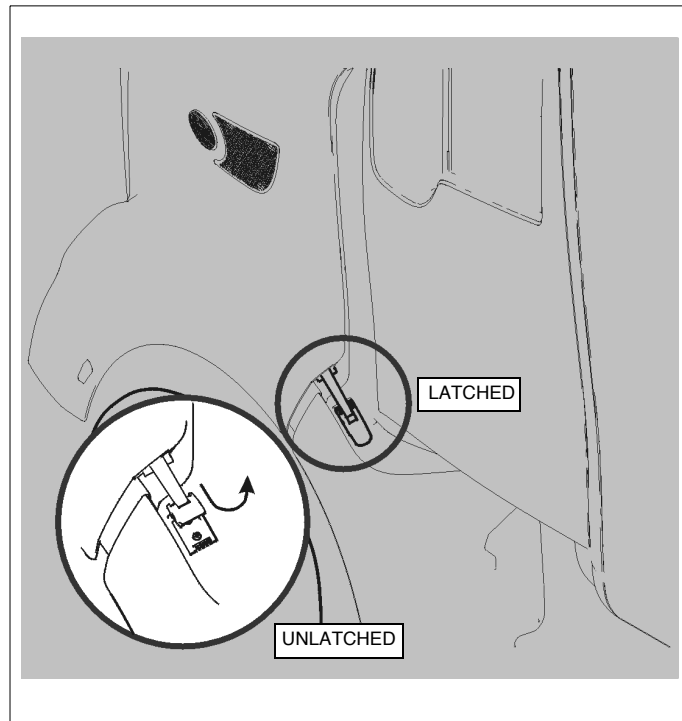

2. Locate the hood anti-blowdown device mounted to the driver side hood dampener.



WARNING! The hood uses two struts to control movement during opening and closing. Do not tilt the hood with one or both struts disconnected. Replace damaged, worn, or leaking struts as soon as possible. Tilting a hood with either strut disconnected or defective may cause the hood to tilt too rapidly. You could be killed or injured and the hood could be damaged.

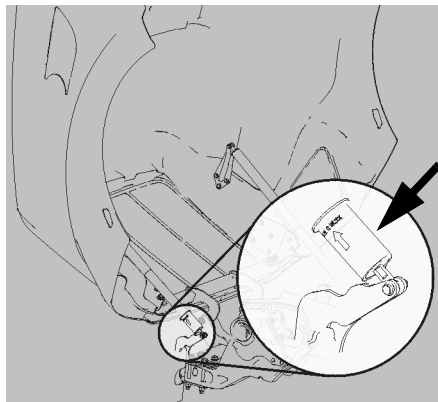

Hood antiblowdown device

3. Verify that the device was previously reset during the last hood closing event. This is done by pulling the collar in the downward direction.



WARNING! Always verify that the hood anti-blowdown device has been reset when opening the hood. The device is reset either by fully closing the hood or by manually pulling the device down. Failure to reset the antiblowdown device may lead to a hood closing unintentionally which can cause death or personal injury to anyone under the hood.

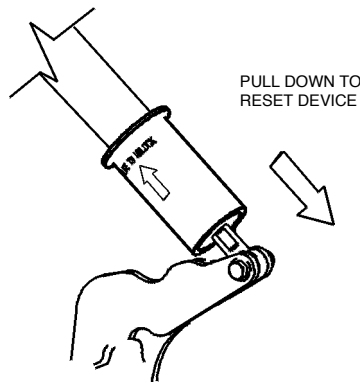

- To close the hood, disengage the hood antiblowdown device by pushing it in the upward direction. The device will move about 1/4" up the shaft. You may feel a click when the device disengages.

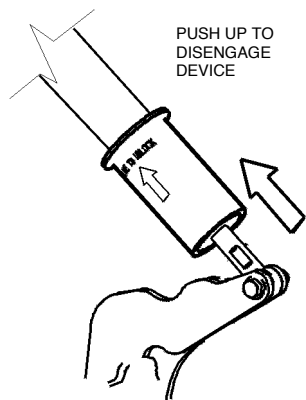

CAUTION: Attempting to close a hood without disengaging the hood antiblowdown device may cause equipment or vehicle damage.

- Firmly push upward and rearward on the hood ornament to start the hood tilting backwards. Continue to push until the hood comes is fully closed.

- Secure the hood latches on both sides of the vehicle to hold the hood in the closed position.



WARNING! If the hood is not latched securely, it could open during operation and cause an accident involving death or injury. Be sure the hood is latched securely before moving the vehicle.

PART 4: CONTROLS AND DISPLAYS

This part explains the location of the various features on your vehicle and describes their function. For information on using these features in driving, see the paragraphs below.

Your Instrument Panel

Please remember that each vehicle is custom-made. Your instrument panel may not look exactly like the one in the pictures that follow.

We have tried to describe the most common features and controls available, so your vehicle may not have some of the ones that appear in this section. You can pick out the parts that apply to you and read them to be fully informed on how your particular vehicle operates.



WARNING! Use extreme caution when using devices while driving (such as cellular telephones) that distracts you from safe driving practices. Failure to properly concentrate on the driving task can result in an accident involving death or personal injury. Limit the use of such devices to when it is safe to do so; not while operating the vehicle.

Typical Cab Instruments and Controls

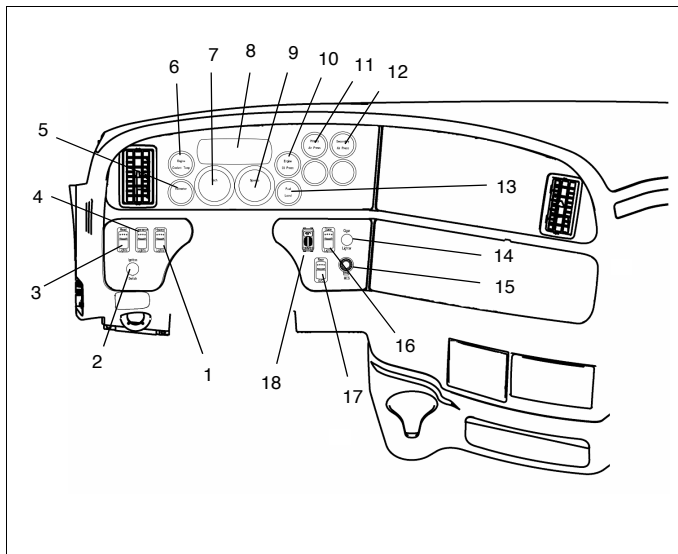

LEFT SIDE

- | | |
|-------------------------------|----------------------------|
| 1. Hazard Switch | 10. Oil Pressure |
| 2. Ignition Switch | 11. Primary Air Pressure |
| 3. Headlight Light Switch | 12. Secondary Air Pressure |
| 4. ID/Clearance Lamps Switch | 13. Fuel |
| 5. Voltmeter | 14. Cigarette Lighter |
| 6. Engine Coolant Temp | 15. Menu Control Switch |
| 7. Tachometer | 16. Rear A/C Switch |
| 8. Driver Information Display | 17. Dome Light Switch |
| 9. Speedometer | 18. Panel Dimmer |

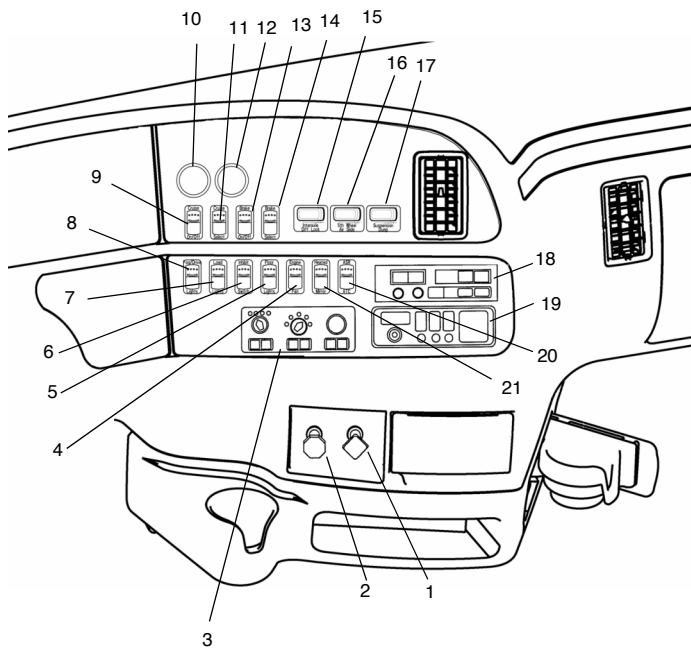

RIGHT SIDE

- | | |
|-------------------------------|--|
| 1. Parking Brake Valve | 12. Optional |
| 2. Trailer Air Supply Valve | 13. Engine Brake |
| 3. Heater/AC Control Panel | 14. Engine Brake Sel |
| 4. Engine Fan Switch | 15. Interaxle Differential Lock Switch |
| 5. Floor Light Switch | 16. 5th Wheel Lock Switch |
| 6. Regeneration Switch | 17. Air Suspension Switch |
| 7. Load Light Switch | 18. Radio |
| 8. Fog Lights Switch | 19. CB Radio |
| 9. Cruise Control Switch | 20. Traction Control Switch |
| 10. Transmission Temperature | 21. Mirror Heater Switch |
| 11. Cruise Control Sel Switch | |

Instruments And Controls

Menu Control Switch (MCS)

The MCS is used to navigate the Driver Information Display unit. The Menu Control Switch is located on the D Panel as shown in the illustration below.

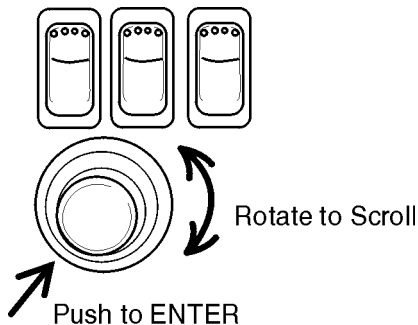

The MCS has the following functions:

- Rotating the MCS
 - Selecting display
 - Setting values
- Pushing the MCS
 - Confirming desired selection

Standard Warning Lights and Audible Alarm

The warning lights and audible alarm may indicate a system malfunction. Check the lights frequently, and respond properly as soon as you see one go on. These lights could save you from a serious accident.



WARNING! Do not ignore a warning light or audible alarm. These signals tell you something is wrong with your vehicle. It could be a failure in an important system, such as the brakes, which could lead to an accident involving death or personal injury. Have the appropriate system checked immediately.

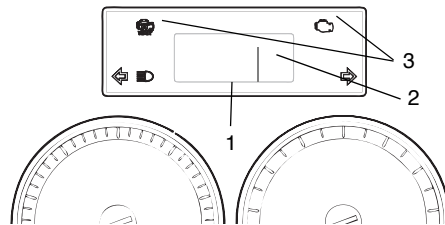

1. Driver Information Display

2. Status Indicator

3. Light Bar

Warning lights and indicator symbols will be shown in both areas 1 and 2. Area 3 includes the turn and high beam indicator symbols.

1. Driver Information Display:

The display can show up to six warning lights. Warnings do not have fixed positions and are displayed in order of criticality. The most critical warning will be displayed on the top row and to the left. If more than six warnings are active, the menu control switch (MCS) can be used to scroll through the additional warnings.

2. Status Indicator:

Additional lights and indicator symbols are displayed in the Status Indicator. They are limited to:

- a. Park Brake
- b. Transmission Gear (Automatic transmissions only)
- c. Warnings:

1

Number of active warnings.



A red warning is active.



An amber warning is active.

- d. Cruise Control - active
- e. Clock alarm bell

Refer to “Warning Light / Indicator Symbols” on page 20 for information on each symbol.

Instrument System Self Test:

When the ignition switch is turned on the instrumentation system will undergo a Self Test. This test will verify the operation of the gauges and warnings.

During the Instrumentation System Self Test, three screens will sequentially display warning icons (approximately 3 seconds each screen) on the Information Display. These are:

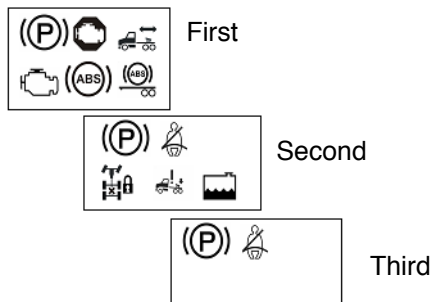

Refer to “Warning Light / Indicator Symbols” on page 20 for information on each symbol.

Completing this sequence will indicate a successful Self Test. Have your instrumentation system checked by a qualified service technician if does not successfully complete.

Audible Alarm:

The audible alarm will sound during the Instrumentation System Self Test. The audible alarm will also sound in conjunction with most warning lights. These events

include but are not limited to headlight on, fifth wheel, stop engine, primary/secondary air, and driver door open warnings.

Optional Lights:

Additional lights may be operational depending on individual vehicle specifications. These will be included in the Instrument System Self Test.



NOTE: Some optional lights may illuminate even though your vehicle is not equipped with that particular feature.

Warning Light / Indicator Symbols









The following is a list of Warning Light / Indicator Symbols. Reading left to right, the table header identifies

- the Symbol Name
- the appearance of the Symbol
- the Symbol Color when it is illuminated
- whether the symbol is standard (Std) or optional (Opt)
- the Page Number reference for additional information









Symbols are listed by major component sections.

Example: Engine, and then in alphabetical order.









Warning Light / Indicator Symbols

Symbol Name	Symbol	Color	Std	Opt	Page
1. Active Warnings, Exclamation Point		Red	•		23
2. Active Warnings, Number		Yellow	•		23
3. Active Warnings, Triangle		Yellow	•		23
4. Alternator		Red		•	23
5. Anti-Lock Brake System (ABS)		Yellow	•		23
6. Anti-Lock Brake System (ABS), Trailer		Yellow	•		24
7. Axle, Inter-Axle Differential Locked (Tandem Axles)		Yellow	•		24
8. Clock, Alarm Bell		Yellow	•		24
9. Cruise Control, Active		Yellow	•		24









Warning Light / Indicator Symbols

Symbol Name	Symbol	Color	Std	Opt	Page
10. Dump Truck, Body Up		Yellow		•	24
11. Dump Truck, Trailer Body Up		Yellow		•	25
12. Emissions, Diesel Particulate Filter (DPF)		Yellow	•		25
13. Emissions, High Exhaust System Temperature (HEST)		Yellow	•		25
14. Emissions, Malfunction Indicator Lamp		Yellow	•		26
15. Emission, Diesel Exhaust Fluid Lamp		Yellow	•		26
16. Engine, Check Engine		Yellow	•		26
17. Engine, Ether Start		Green		•	26
18. Engine, Heater		Yellow		•	26





Warning Light / Indicator Symbols

Symbol Name	Symbol	Color	Std	Opt	Page
19. Engine, Low Coolant Level		Yellow	•		26
20. Engine, Overspeed		Red		•	27
21. Engine, Retarder (Brake)		Green		•	27
22. Engine, Stop Engine		Red	•		27
23. Engine, Wait To Start		Yellow		•	27
24. Fifth Wheel, King Pin Lock		Red		•	27
25. Fifth Wheel, Slide Unlocked		Red	•		27
26. Lights, High Beam		Blue	•		28
27. Message Waiting		Green		•	28

Warning Light / Indicator Symbols

Symbol Name	Symbol	Color	Std	Opt	Page
28. Park Brake		Red	•		28
29. Power Take-off (PTO)		Green		•	28
30. Power Take-off (PTO), Pump Mode	PUMP MODE	Green		•	28
31. Refrigerator		Green		•	28
32. Seat Belt, Fasten		Red	•		28
33. Suspension Dump		Yellow	•		28
34. Tire Inflation		Yellow		•	29
35. Transmission, Auxiliary		Yellow		•	29
36. Transmission, Check		Red		•	29

Warning Light / Indicator Symbols

Symbol Name	Symbol	Color	Std	Opt	Page
37. Transmission, Do Not Shift		Red		•	29
38. Transmission, Oil Filter		Yellow		•	29
39. Transmission, Oil Temperature High		Yellow		•	29
40. Turn Signal, Left		Green	•		29
41. Turn Signal, Right		Green	•		29

Warning Light/Indicator Symbol Descriptions



1. Active Warnings, Exclamation Point

Illuminates when a red warning is active. Use the MCS knob to view the warnings that are active. Refer to the preceding Figure , “Warning Light / Indicator Symbols,” on page 20 for warning color classification.



2. Active Warnings, Number

Illuminates the total number of red and yellow active warnings. Use the MCS to view the active warnings if the display shows a > symbol.



3. Active Warnings, Triangle

Illuminates when an yellow warning is active. Use the MCS knob to view the warnings that are active. Refer to the preceding Figure , “Warning Light / Indicator Symbols,” on page 20 for warning color classification.



4. Alternator

Illuminates if the alternator is not charging. (For alternators with warning lamp output signal.)



5. Anti-Lock Brake System (ABS)

Illuminates during the Instrumentation System Self Test. Have the ABS system checked by a Peterbilt dealer if the ABS Warning Lamp stays on for more than 3 seconds.

Illuminates during normal operating conditions to indicate a problem with the ABS System. See “ABS Warning Lamps” on page 109 for more information.

Illuminates when a problem exists with the optional Wheel Spin Control feature. See “Advanced ABS with Stability Control” on page 106 more information.



6. Anti-Lock Brake System (ABS), Trailer

Illuminates during the Instrumentation System Self Test **and** the tractor/truck is connected with a ABS equipped trailer.

Illuminates during normal operating conditions to indicate a problem with the Trailer ABS System. This should be checked by a Peterbilt dealer as soon as possible. See "Truck/Tractor ABS Warning Lamp" on page 109 for more information.



NOTE: Tractors/Trucks and trailers built after 3/1/01 must be able to turn on an In-Cab Trailer ABS Warning Lamp (per U.S. FMVSS121). The industry chose Power Line Communication (PLC) as the standard method to turn it on. See "Trailer ABS Warning Lamp" on page 110 for more information. On trailers built prior to 3/1/01 verify trailer ABS system status via the required external warning lamp mounted on the trailer. The indicator lamp on the trailer should be yellow and identified with the letters "ABS".



7. Axle, Inter-Axle Differential Locked (Tandem Axles)

Illuminates when the inter-axle differential switch is ON thus locking the inter-axle differential. This powers the forward rear and the rear rear differentials equally. When the switch is turned off (inter-axle differential unlocked) the engine power is allowed to flow to any of the 4 drive tires based on the differential effect (mostly to the forward rear differential). (This feature is standard on all tandem axles).



8. Clock, Alarm Bell

Illuminates when the alarm is set. It will flash when the clock alarm is active.



9. Cruise Control, Active

Illuminates when cruise control is active.



10. Dump Truck, Body Up

Illuminates when Truck Dump Body is up.



11. Dump Truck, Trailer Body Up

Illuminates when Trailer Dump Body is up.



12. Emissions, Diesel Particulate Filter (DPF)

Illuminates when diesel particulate trap is plugged. This warning will also illuminate when regeneration operation is disabled.



NOTE: Refer to “Exhaust After-Treatment System” on page 126 for more information regarding this warning icon.



13. Emissions, High Exhaust System Temperature (HEST)

Illuminates when the exhaust gas temperature and exhaust components become extremely hot.



Refer to “Exhaust After-Treatment System” on page 126 for more information regarding this warning icon.



WARNING! Temperatures of the exhaust pipes and at the outlets of the exhaust system during and shortly after a regeneration event will be extremely hot. If the High Exhaust System Temperature (HEST) warning lamp is on:

•Do not park in an area of combustible vapors or materials. You must keep combustibles at least five (5) feet away from the side and top of the vehicle while the HEST light is illuminated. Always park your vehicle outside. Failure to do so could ignite an explosion or harm bystanders which could result in death or serious injury.

•Do not park in an area where people are close by. You must keep bystanders at least five (5) feet away from the exhaust outlet while the HEST light is illuminated. Failure to do so could result in death or serious injury.

•The exhaust piping, diesel particular filter (DPF) or tail pipe become extremely hot during engine operation or any regeneration event and can cause death or serious burns

to the skin. Allow adequate cooling time before working on or near any part of the exhaust system.



14. Emissions, Malfunction Indicator Lamp

Illuminates when an engine emissions failure has occurred. The vehicle can be safely driven but should be serviced to correct the problem. The situation should not be considered an emergency. In some cases, the Malfunction Indicator Lamp will activate in conjunction with the High Exhaust Temperature, Diesel Particulate Filter (DPF) and Diesel Emission Fluid (DEF) Warning Lights.



15. Emission, Diesel Exhaust Fluid Lamp

Illuminates when the Diesel Exhaust Fluid (DEF) tank level is low. The vehicle can be safely driven but the DEF tank should be filled at the next opportunity. The situation should not be considered an emergency.



16. Engine, Check Engine

Illuminates when a problem exists, but the vehicle can still be safely driven. Vehicle should be serviced to correct the problem but the situation should not be considered an emergency.



17. Engine, Ether Start

Illuminates when ether start switch is on.



18. Engine, Heater

Illuminates when Engine Heater switch is on.



19. Engine, Low Coolant Level

Illuminates with an audible alarm indicating critically low coolant level. The vehicle must be serviced to correct the problem but the situation should not be considered an emergency.

**20. Engine, Overspeed**

Illuminates when engine RPM is exceeded.

**21. Engine, Retarder (Brake)**

Illuminates when the engine retarder (compression brake or exhaust brake) switch is turned on. (Engine retarders are an option.)

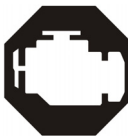
**22. Engine, Stop Engine**

Illuminates and an audible alarm tone will sound when a major engine system problem exists.



WARNING! This should be considered an emergency. You should stop the vehicle as safely as possible and turn OFF the ignition. The vehicle must be serviced and the problem corrected before driving again. Failure to do so may cause severe engine damage or cause an accident involving death or personal injury.

**23. Engine, Wait To Start**

Illuminates when engine grid heater is on (Cummins ISB and ISC engines).

**24. Fifth Wheel, King Pin Lock**

Illuminates when air actuated fifth wheel King Pin is unlocked.

**25. Fifth Wheel, Slide Unlocked**

Illuminates and an audible warning tone will sound when the air operated sliding fifth wheel switch is on, thus unlocking the sliding fifth wheel. The light and an audible warning tone should NOT be considered an emergency but simply as a reminder to turn off the switch to lock the sliding fifth wheel before driving. This switch should not be operated while driving. (Sliding fifth wheels are an option).



26. Lights, High Beam

Illuminates when the high beams are on. This icon will flash with audible alarm if the headlamps are left on when the door is open. In addition, this icon will flash, but without an audible alarm, if there is a problem with the low beam headlights or the low beam headlight wiring. In such event, the high beam headlights will turn on at 50% normal brightness.



27. Message Waiting

Illuminates with telematic equipped messaging.



28. Park Brake

Illuminates in the status indicator when parking brakes are applied and the vehicle is stationary. This symbol will also illuminate in the Driver Information Display if the parking brakes are applied and the vehicle is in motion.



29. Power Take-off (PTO)

Illuminates when the PTO is engaged.



NOTE: Do not drive vehicle with PTO engaged.

PUMP MODE

30. Power Take-off (PTO), Pump Mode

Illuminates with remote throttle application. Indicates pump mode is active.



31. Refrigerator

Illuminates to indicate that the refrigerator is on and ignition is off.



32. Seat Belt, Fasten

Illuminates when the ignition key is turned on as a reminder to fasten your seat belt.



33. Suspension Dump

Illuminates when suspension air bags are deflated.



34. Tire Inflation

Illuminates when tire pressures need to be checked. (Tire Pressure Monitoring System is an option)



35. Transmission, Auxiliary

Illuminates to indicate auxiliary transmission is in neutral.



36. Transmission, Check

Illuminates when transmission has recorded a fault code. This icon may also appear in the Transmission Display menu of the Driver Information Display unit (see item G; page 33). If the user is in this display menu, the icon does not indicate a fault code.



37. Transmission, Do Not Shift

Illuminates with automatic transmissions equipped with “Don’t Shift” output.



38. Transmission, Oil Filter

Illuminates when service is required (Allison transmissions only).



39. Transmission, Oil Temperature High

Illuminates when transmission lubricant temperature is too high.



CAUTION: This should be considered an emergency. You should stop the vehicle as safely as possible and turn OFF the ignition. The vehicle must be serviced and the problem corrected before driving again. Failure to do so may cause severe transmission damage.



40. Turn Signal, Left

Blinks when the left turn signal or the hazard light function is operating.



41. Turn Signal, Right

Blinks when the right turn signal or the hazard light function is operating.

Driver Information Display

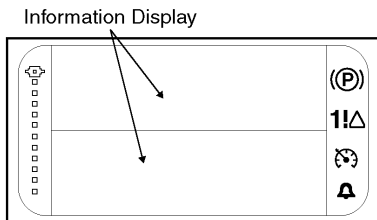

WARNING! Do not look at the Driver Information Display for prolonged periods while the vehicle is moving. Only glance at the monitor briefly while driving. Failure to focus to the vehicle's road position could lead to an accident involving death, possible personal injury or equipment damage.

The Driver Information Display, located at the top of the instrument cluster, displays important vehicle information through a constant monitoring of systems when any of the following conditions are met:

- ignition key in ON or ACC positions
- ignition timer is active

- MCS button is pushed (independent of ignition key switch position)
- clock alarm sounds
- driver or passenger door is opened
- hazard warning lamp switch is on

The various functions may be accessed by navigating through Menu Screens using the MCS. Refer to "Menu Control Switch (MCS)" on page 17 for more detail for the MCS.

The bullets in the Menu Bar allow access to each item by pushing the MCS when the desired bullet is highlighted.

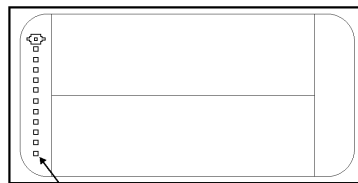

Menu Bar

In addition to a blank screen, the following are menu items and the information available within each menu selection.



NOTE: Some Driver Information Display functions are only accessible when the vehicle is parked. Other functions are accessible while the vehicle is moving or when parked. Each function is identified in the following descriptions.

A. **Fuel Economy** (Accessible while parked or driving)

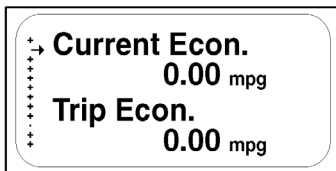

1. Current fuel economy - Indicates instantaneous fuel economy.
2. Trip fuel economy - Indicates trip fuel economy.

B. **RPM Detail** (Accessible while parked or driving)

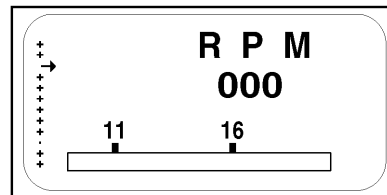

RPM reading of actual engine RPM. Engine RPM within the bar graph indicates the engine is operating in the most efficient RPM range. The display color will change if you are operating outside of this range.

C. **Ignition Timer** (Accessible while parked only)

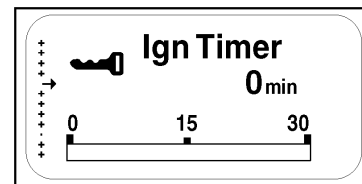

Ignition timer is set from this menu. The ignition timer may be set for up to 30 minutes.

D. Trip Information

NOTE: When accessing the trip information menu, push the MCS on this menu (bullet). To exit, push the MCS again. To reset the trip values, press the Trip Odometer Reset Button on the main gauge instrument cluster.

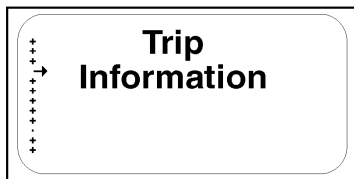

Certain Trip Information functions area accessible when driving or when parked:

- Trip Economy
- Trip Average Speed

Other Trip Information functions are accessible only when parked:

- Trip Distance
- Trip Engine Hours
- Trip Idle Hours
- Trip Idle Percentage (%)

- PTO Hours
- PTO Trip Hours
- PTO Trip Percentage (%)

To reset the Trip Values, press the Trip Odometer Reset Button on the main gauge instrument cluster.

E. Truck Information (Accessible only while parked)

NOTE: When accessing the truck information menu, push the MCS on this menu (bullet). To exit, push the MCS again.

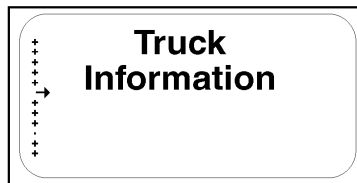

1. Chassis Number
2. Engine Make
3. Engine Model
4. Engine SW Version
5. Transmission Make
6. Transmission Model

7. Transmission SW Version
8. ABS (Antilock Braking System) Make
9. ABS Model
10. ABS SW Version
11. CECU (Cab Electronic Control Unit) Software Version
12. CECU Hardware Version

F. **Diagnostic Display** (Accessible only while parked)



NOTE: "Faults Found" will only be active if a red or yellow warning lamp is illuminated.

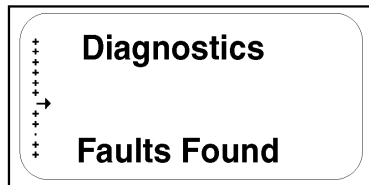

The diagnostic display menu (bullet) will indicate a fault that is generated by the vehicle's Engine, ABS and/or Transmission systems. While on this menu item the display will either indicate "No Faults

Found" or "Faults Found". If "Faults Found" is active, pushing the MCS will display new menus for more information.

G. **Transmission Display** (Automated Transmissions only - Accessible while parked or driving)



NOTE: Refer to the Automated Transmission Operator's Manual for additional information.



This menu will show gear number that coincides with the current transmission gear selected. The menu also displays the transmission icon to let the user know what screen they are in. (Does not indicate a fault code.)

H. **Settings Menu** (Accessible only while parked)

The Settings menu screen allows the driver to view and/or change the following menu items:

- Display Format 12 Hour (AM/PM) or 24 Hour (military)
- Home/Local Time
- Alarm ON/OFF
- Alarm Time
- Units of measure
- Language (English, Spanish or French)

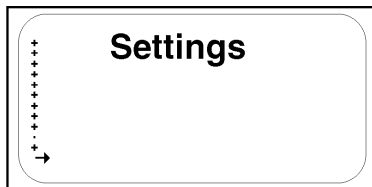

To Set Clock Display Format:

1. When in the Settings Menu, scroll through the list of menu items to "Format".
2. Press the MCS to display either 12 hour (AM/PM) or 24 hour (military) time.



To Set Home, Local or Alarm Time:

1. When in the Settings Menu, scroll through the list of menu items. Press the MCS to select the item to change.



3. Rotate the MCS knob to change the hour. Press the MCS.

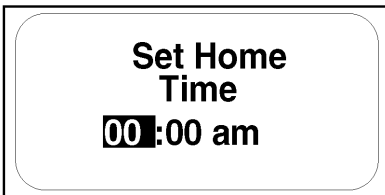

4. Rotate the MCS knob to change the minutes. Press the MCS.
5. Rotate the MCS to toggle AM/PM. Press the MCS
6. Rotate the MCS to select Exit. Press the MCS to exit the settings function.

To Turn Alarm ON/OFF:

1. When in the Settings Menu, scroll through the list of menu items to "Alarm". Press the MCS.
2. Press the MCS to turn the alarm ON or OFF.

To Set Units of Measure:

1. When in the Settings Menu, scroll through the list of menu items to "Units". Press the MCS.
2. Press the MCS to display either Standard or Metric units.

To Set Language:

1. When in the Settings Menu, scroll through the list of menu items to "Language". Press the MCS.
2. Rotate the MCS to display either English, Spanish or French. Press the MCS knob to select the desired language.

Steering Column-Mounted Controls

Turn Signal and Indicator Lights



NOTE: The ignition key must be turned to ON for the signal/switch to operate.

Your turn signal lever is mounted on the left side of the steering column below the steering wheel. Green directional indicator lights appear on the instrument panel. To operate the signal, move the lever in the direction of the turn. Each time the turn indicator is activated the audible alarm emits a short beep.

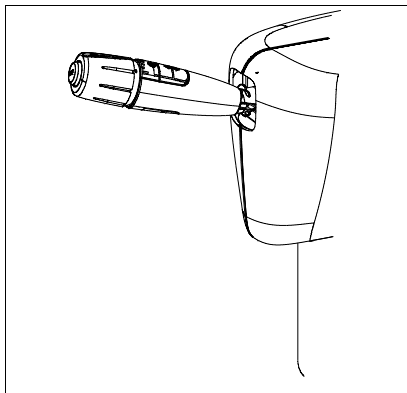

High Beam Headlamps



NOTE: The headlamps must be “ON” for the high beam switch to operate.

To switch your headlamps to lower or higher beam, gently pull the turn signal lever towards the steering wheel, until you hear the switch click and the beam changes. The blue indicator light in the instrument panel will be ON when the high beam is being used.

To return to previous beam: pull the lever towards the steering wheel again.

Headlamp Flash

To activate headlamp flash, gently push the turn signal lever away from the steering wheel until you hear and feel the switch click. Release lever to deactivate.

- If your headlamps are off, low beams will flash on.
- If your headlamps are on, they will dim. Maximum duration of dimming is 3 seconds. When the function ends, your headlamps will return to low beams.

ID And Clearance Lights Flash

To flash, press the button on the end of the turn signal lever and hold. To cancel the flash, release the button.

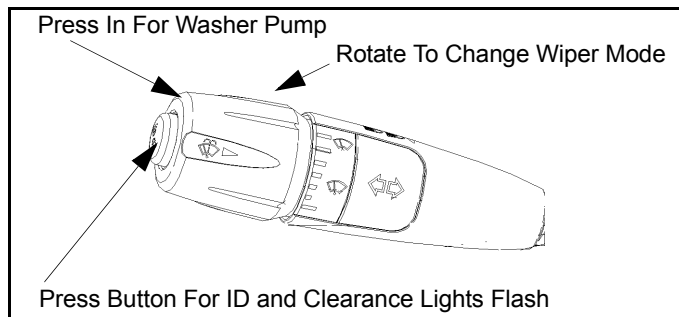

If your ID and clearance lights are on, they will flash off.

Windshield Wipers/Washer

Your vehicle is equipped with a two-speed, intermittent windshield wiper system. A seven-position rotary wiper switch (located on the turn signal lever) operates the windshield wipers and washer (see next illustration). Rotate the end of the turn signal lever to change the wiper mode.



NOTE: The ignition key must be turned to ON or ACC for the wiper/washer switches to operate.

The first position after OFF is the intermittent #1 cycle. The next positions are intermittent #2, #3, and #4. The last two positions are wiper low speed and wiper high speed. See the wiper switch settings table that follows for intermittent delay times.

Wiper Switch Settings	
Wiper Switch Position	Wiper Speed
Off	Off
Intermittent #1	20 Second Delay
Intermittent #2	17 Second Delay
Intermittent #3	7 Second Delay
Intermittent #4	4 Second Delay
Low	Low Speed
High	High Speed

To Wash The Windshield

Push the rotary wash/wipe knob in (towards steering column), hold for more than 0.8 seconds and then release. Hold the knob in to extend the washing cycle. After the

lever is released, the wipers will shut off automatically or resume the wiper's setting speed.

To activate the wipers for one swipe without activating the washer ("mist" function), push the turn signal lever in (towards the steering column) and release in less than 0.5 seconds. The wipers will perform a single swipe and then resume the wiper's setting speed.



WARNING! Clean blades regularly with a damp cloth to remove road film and wax build-up. Do not drive with worn or dirty wiper blades. They can reduce visibility, making driving hazardous which may lead to an injury accident resulting in death or personal injury.



CAUTION:

- ***Do not use antifreeze or engine coolant in the windshield washer reservoir—damage to seals and other components will result.***
- ***If the electric pump is operated for a long period (more than 15 seconds) with a dry reservoir, the pump motor may be damaged.***

Check the windshield washing fluid level daily. If necessary, fill to top.

Clean all inside and outside windows regularly. Use an alcohol-based cleaning solution and wipe dry with either a lint-free or a chamois cloth. Avoid running the wiper blades over a dry windshield to prevent scratching the glass. Spray on washer fluid first. A scratched windshield will reduce visibility.

Hazard Flasher

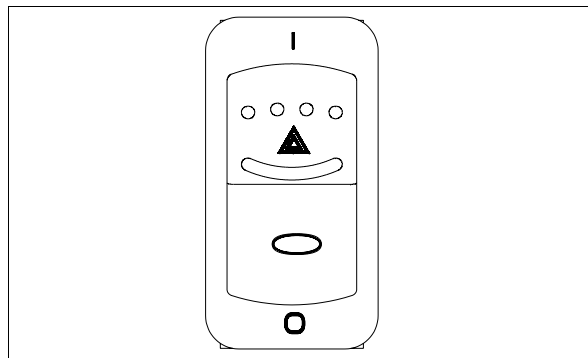

The four-way Hazard Flasher switch is on the turn signal body, just underneath the turn signal lever. It will operate with the key switch in the ON or OFF position. Use your hazard flasher whenever you are off the road or on the side of the road, or in a potentially hazardous situation. Pull it out to activate the system. All turn signals will flash at once. To turn it off, move the turn signal lever up or down.



WARNING! Use your Hazard Flasher Warning System any time you have to stop the vehicle on or off the road, day or night. A hard-to-see vehicle can result in an accident causing death or personal injury. Another vehicle could run into you if you do not set your flashers and follow the placement of emergency signals per FMCSR 392.22. Always move the vehicle a safe distance off the road when stalled or stopped for repairs. A disabled vehicle can be dangerous for you and others.

Of course, in normal stopping in traffic, such as at a stop light, you do not use your flashers.



WARNING! Your disabled vehicle can be dangerous for you and others. The hot exhaust system could ignite dry grass, spilled fuel, or other substances. Do not park or operate your vehicle where the exhaust system could contact dry grass, brush, spilled fuel, or any other material that could cause a fire resulting in death or personal injury.

Electric Horn

Your Peterbilt has an electric horn. To sound the horn, press on the bar in the center of the steering wheel.

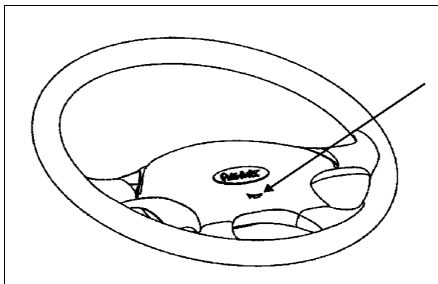

Electric Horn Bar

Air Horn

Your vehicle has an air horn in addition to an electric horn. Control the air horn by pulling on the lanyard extending from the overhead header panel.

Trailer Brake Hand Valve

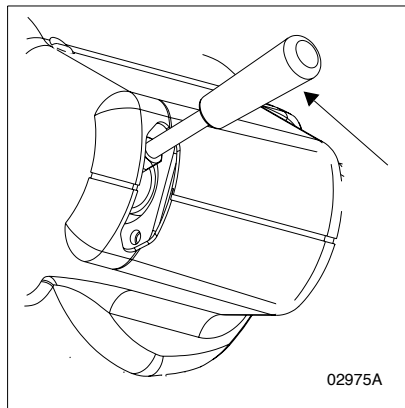

This hand valve provides air pressure to apply the trailer brakes only. It operates independently of the foot treadle valve.



NOTE: The trailer brake is not to be used as the main means of braking. To use this brake frequently instead of using the foot brake will wear out the trailer brake sooner.

To operate the trailer brake hand valve: pull down on the lever under the right side of the steering wheel.

See the Index, under Brake Safety and Emergency for more complete information on when and how to use your trailer brake



WARNING! *It is dangerous to use air-applied trailer brakes for parking or holding a vehicle. Air system pressure can bleed down and release the brakes. You could have a vehicle roll-away resulting in an accident involving death or personal injury. Always apply the parking brakes for parking or holding your vehicle on grade.*

Tilt-Telescoping Steering Column

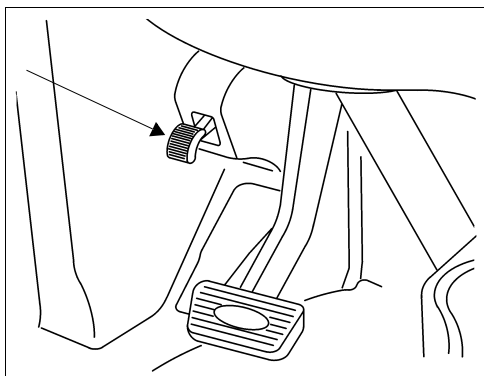

Tilt-Telescope Lever

The telescoping feature of the steering wheel allows forward and rearward movement of the wheel. The tilting feature allows you to move the wheel up and down.



WARNING! *Make all adjustments to the steering mechanism while the vehicle is stopped. Adjusting the Tilt-Telescoping Steering Wheel while the vehicle is in motion could cause loss of control. You wouldn't be able to steer properly and could have an accident resulting in death or personal injury.*

To position the wheel: Locate the Tilt-Telescope Lever on the floor, to the left of the steering column. Push this lever toward the floor. Move the steering wheel to the desired angle and height. Release the lever to lock in the correct position.

Dash-Mounted Features

Keys and Locks

The same key fits your ignition, doors, and sleeper luggage compartment. Frame-mounted tool box locks, locking fuel tank caps, and glove boxes each have individual keys.

Ignition Switch

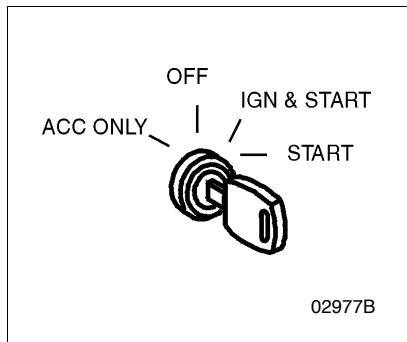

Your ignition switch has four positions:

- **ACC (Accessory):** With your key in this position you can play the radio or use other accessories, but your engine won't start.
- **OFF:** In this position all systems are off, and you can remove your key.
- **IGN & ACC:** This position allows you to turn on the engine and all accessory power.
- **START:** Starter activation to start engine.

Headlamps

The headlamps are controlled by the control panel switch showing the next symbol. When the headlights are ON, the dash lights, side, and tail lamps are also on.

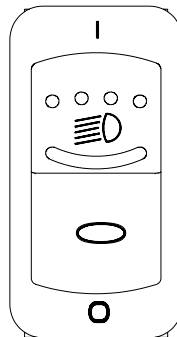

WARNING! Do not use daytime running lights (DRL) during periods of darkness or reduced visibility. Do not use DRL as a substitute for headlamps or other lights during operations that require lighting of your vehicle. Doing so could lead to an accident involving death or personal injury.

On vehicles equipped with daytime running lights (DRL), the high-beam headlamps go on automatically at reduced

brightness if the engine is running and the headlamp switch is turned off. The daytime running lights are turned off automatically while the parking brake is engaged. If the headlamp switch is turned on, the DRL system is overridden & headlamps operate normally

Panel Light Knob

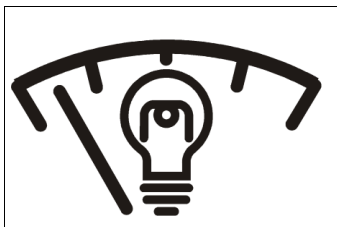

The Panel Light Knob lets you vary the brightness of your instrument panel lights.

To Operate Your Panel Light Knob:

1. Turn on either the headlights or clearance lights.
2. To brighten the instrument lights, rotate the thumbwheel up.
3. To dim the instrument lights, rotate the thumbwheel down.

ID and Clearance Lights Switches

These are the amber lights on top of your cab, the lights on the front and sides of the trailer and the red lights on the rear of a truck or trailer. They may be turned on and off by the switch located on the lower left control panel labeled CL LPS and showing the symbol below.

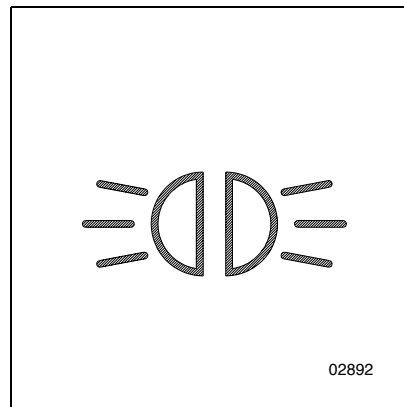

When your clearance lights are turned on, you may blink or flash them by operating the flash switch located on the right side of the dash showing the symbol below. Press and release this rocker switch to flash your clearance lights.

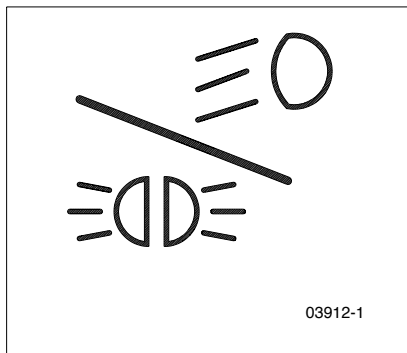

Fog/ Driving Lights Switch

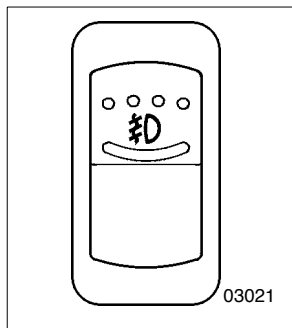

If your vehicle has fog/driving lights, turn them ON or OFF with the control panel switch shown above.



NOTE: State requirements vary as to when high beams and fog lights can and cannot be used together. Further, some states allow only four lights to be used together; some allow more. Whether you have dual or composite lights will affect how many lights you can have on at one time. Always comply with the state requirements where you are driving.

Dome Light Switch

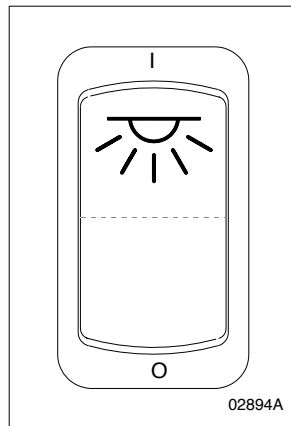

A momentary switch controls the main dome light:

- OFF (O) Position: Light is off.

- ON (I) Position:
 - Press once: Light will turn on at high intensity.
 - Press again: Light will shift to low intensity.
 - Press a third time: Light will turn off.

Air Suspension Deflate Switch (Dump Valve)

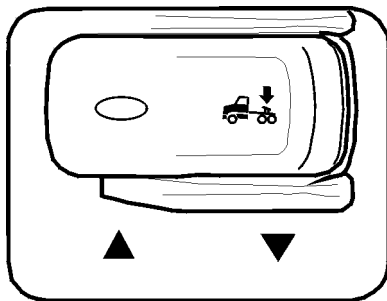

03035

This vehicle may have an air suspension deflation switch that allows the air in the suspension to be exhausted from a switch on the dash. The purpose of this feature is to allow you to lower your tractor to get under a trailer. You

will notice a guard over the switch. This prevents you from accidentally deflating the suspension.



WARNING! Operating the Air Suspension Deflate Switch (Dump Valve) while driving can lead to an accident causing death or personal injury. Sudden deflation while your vehicle is moving can affect handling and control. Use this switch only when your vehicle is not moving.



CAUTION: Operating a vehicle with air suspension bags either overinflated or underinflated may cause damage to driveline components. If a vehicle must be operated under such conditions, do not exceed 5 mph.

Engine Fan Switch

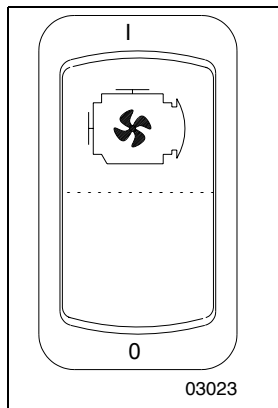

The engine fan switch allows you to control the engine fan manually or automatically. With the ignition key switch ON and the fan switch in the ON position, the engine fan will be on regardless of engine temperature. With the engine fan switch in the AUTOMATIC position, the engine fan will automatically turn on when the engine coolant reaches a temperature of about 200°F.



WARNING! Do not work on the fan with the engine running. Anyone near the engine fan when it turns on could be killed or seriously injured. If it is set at ON, it will turn on any time the ignition key switch is turned to the ON position. In AUTOMATIC, it could engage suddenly without warning. Before turning on the ignition or switching from AUTOMATIC to ON, be sure no one is near the fan.



CAUTION: The fan or equipment near it could be damaged if the fan turns on suddenly when you don't expect it. Keep all tools and equipment such as rags away from the fan, and take care no one turns on the ignition when someone is working near the fan.



CAUTION: Do not operate the engine fan in the manual (ON) position for extended periods of time. The fan hub was designed for intermittent operation. Sustained operation will shorten the fan hub's service life as well as reduce fuel economy.

Mirror Heat Switch

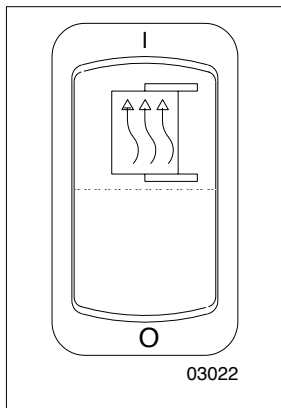

Mirror heat is controlled by the control panel switch shown above. If the vehicle is equipped with this switch, mirror heat can be switched on to help remove frost and ice from the mirror glass.

Power Mirror Switch

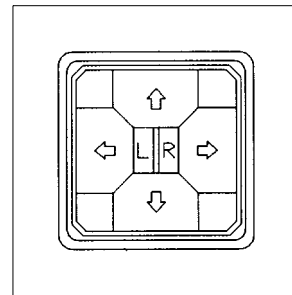

The power mirror control controls the adjustment of the right or left outside mirrors, depending on the option selected. It is located in the driver side armrest.



NOTE: *The Power Mirror Switch does not control the adjustment of the convex mirrors.*



WARNING! *Convex mirrors can distort images and make objects appear smaller and farther away than they really are. You could have an accident resulting in death or personal injury if you are too close to another vehicle or other object. Keep plenty of space between your vehicle and others when you turn or change lanes. Remember that other objects are closer than they may appear.*

Cruise Control Switch

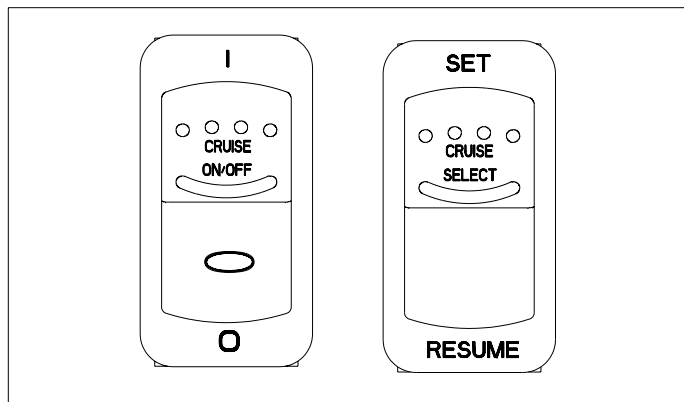

The master switch turns the cruise control ON or OFF. The second switch allows you to SET the desired speed

or RESET the desired speed after the cruise control has been interrupted.



WARNING! *Do not operate the cruise control when operating on road surfaces with poor traction (wet, icy, or snow covered roads) or in heavy traffic. Accelerations caused by the normal operation of the cruise control could cause you to lose control of the vehicle resulting in an accident causing death or personal injury.*



NOTE: *Cruise control functions and features may vary depending upon which engine you have. For specific explanation of your cruise control, see the cruise control or engine manual included with your vehicle.*

This vehicle's electronic system will perform a 'rationality check' every time the vehicle is started. This check is to ensure that the service brakes are working before allowing cruise control to function. This safety feature is designed to ensure that a driver is able to cancel the cruise set speed by using the service brake pedal. The system will not allow cruise control operation if it does not pass the 'rationality check'. The Driver Information Display

will prompt you to press the service brake pedal if it has not been pressed since the vehicle has been started.

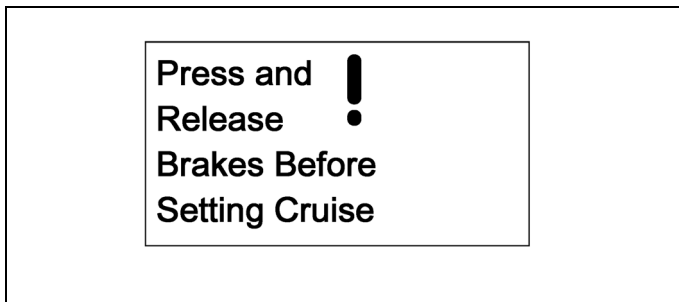

Engine Brake

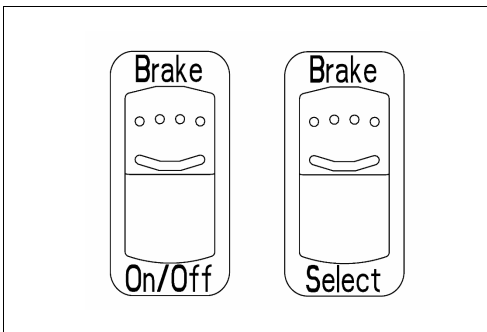

When an engine brake is energized, the power-producing diesel engine is converted into a power-absorbing air compressor to retard the vehicle.

- The brake is energized whenever the driver's foot is completely removed from the accelerator pedal.
- The brake is deenergized during driving by pressure on the accelerator pedal, and during shifting by depressing the clutch pedal.

The ON/OFF toggle switch turns the system ON or OFF.

- In PACCAR, Caterpillar- and Cummins-powered vehicles equipped with a Jacobs Engine Brake, a second two- or three-mode switch is incorporated in the instrument panel. With this system, you can select either LOW or HIGH or LOW/MEDIUM/HIGH retarding.

For more information on when and how to use the engine brake in your vehicle, see the Engine owner's manual for the engine brake.



WARNING! Using the engine brake when operating on surfaces with poor traction (such as wet or icy, slippery roads or gravel) could cause an accident involving death or personal injury.

Two-Speed Rear Axle (Range) Switch

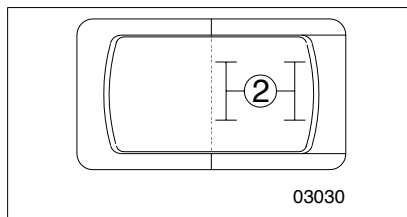

If your vehicle is equipped with a two-speed rear axle, you can select the axle range by the dash mounted switch shown above.

- The low range provides maximum torque for operating off-highway.
- The high range is a faster ratio for highway speeds.

For information on how to operate your two-speed rear axle properly and safely, see [“PART 7: STARTING & OPERATING THE VEHICLE”](#).

Interaxle Differential Lock Switch

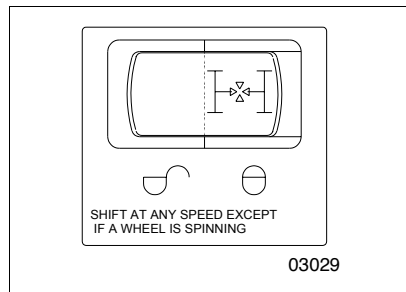

The interaxle differential allows differential action between the forward rear and the rear rear driving axles. The interaxle differential lock switch allows the operator to LOCK or UNLOCK the differential. The guard over this switch prevents you from accidentally activating the lock. See [“Interaxle Differential” on page 101](#) for more information on using your interaxle differential.



WARNING! Do not engage the differential lock if the vehicle is moving or if the tires are slipping. Otherwise, the vehicle may move in an unexpected direction, and could cause an accident involving death or personal injury. This may also lead to equipment damage. Bring the vehicle to a complete stop and ensure that all wheels are not spinning before engaging the differential lock switch.

Regeneration Switch

In order to meet EPA engine emission requirements, vehicles will have either a two or three position switch to help control and maintain the exhaust Diesel Particulate Filter. Please refer to “Exhaust After-Treatment System” on page 126 for more information about the emission control system and how it affects normal operating procedures.

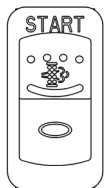

Two Position

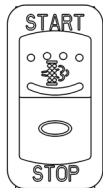

Three Position

START

Depressing the button in the START direction for 4 to 8 seconds will initiate a parked regeneration. Be sure to release the button to ensure that the system will begin the regeneration cycle.

CENTER (three position switch only)

Center is the normal position of the switch.

The center position will allow an automatic regeneration to occur.

STOP (three position switch only)

When STOP is pressed the system will not regenerate under any conditions.



CAUTION: Do not leave the three position switch in the STOP position unless you need to cancel or stop regeneration. Leaving the switch in the STOP position for extended periods of time will result in increased soot levels in the DPF.

Fifth Wheel Lock (Slider Adjustment) Switch

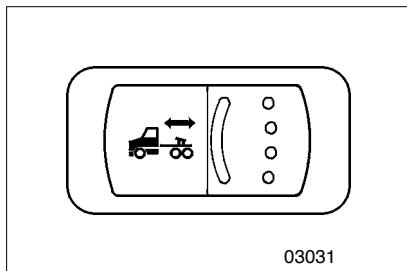

Vehicles having an air slide fifth wheel have a fifth wheel slider lock controlled by a switch on the instrument panel. By placing the switch in the unlock position, you can slide the fifth wheel to various positions to adjust weight distribution. There is a guard over this switch to protect you against accidentally activating or releasing the lock.



WARNING! Do not move the fifth wheel while the tractor-trailer is in motion. Movement of the fifth wheel while a tractor-trailer is moving can cause a serious accident involving death or personal injury. Your load could shift suddenly, causing you to lose control of the vehicle. Never operate the vehicle with the switch in the unlock position. Always inspect the fifth wheel after you lock the switch to be sure the fifth wheel is engaged.



CAUTION: Both the fifth wheel plate and the slide tracks (if a slider) should be cleaned and lubricated periodically to ensure smooth turning and sliding action. Failure to keep these surfaces lubricated can lead to frame or driveline damage.

Parking Brake Valve and Trailer Air Supply Valve

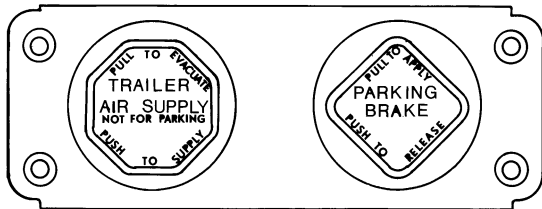

Your parking brake valve is a yellow diamond-shaped knob located below the right instrument panel. It controls the parking brakes.

To apply all parking brakes, pull the yellow, or parking brake, knob out. The truck or tractor parking brakes will set, and the Trailer Air Supply Valve (red octagon knob) will automatically trip (“pop out”) and set the trailer parking brakes. To release both truck/tractor and trailer parking brakes, push in BOTH yellow and red knobs. For full information on using parking brakes, see section titled [“Parking Brakes and Their Use”](#) on page 118 for more information.



WARNING!

- ***Do not leave the cab without applying the parking brake. The truck could roll and cause an accident involving death or personal injury. Always apply the parking brake before you leave the cab***
- ***Do not pull out the parking brake valve while the vehicle is moving. Stopping with the parking brake controls can cause a sudden wheel lock-up, loss of control, or over-take by following vehicles possibly resulting in an accident involving death or personal injury***
- ***Do not use the trailer hand brake or service brakes to park and hold an unattended vehicle—use the parking brakes. Because service brakes work with air pressure, these brakes could slowly release. Your vehicle could roll, causing a serious accident. Someone could be hurt or killed. Never rely on the service brakes to hold a parked vehicle.***



WARNING! Before operating your vehicle after it has been parked, do not forget to push in the parking brake valve to release the parking brakes. Failure to release your parking brakes before putting the vehicle into motion can cause fire or loss of control of the vehicle, which can result in death or personal injury.

Heater-Air Conditioning Controls

Your heat and air conditioning controls are mounted in the right hand instrument panel. Additionally, the sleeper compartment may also contain a separate heating and cooling system with separate controls.



WARNING! Exhaust fumes from the engine contain carbon monoxide, a colorless and odorless gas. Do not breathe the engine exhaust gas. A poorly maintained, damaged or corroded exhaust system can allow carbon monoxide to enter the cab. Entry of carbon monoxide into the cab is also possible from other vehicles nearby. Failure to properly maintain your vehicle could cause carbon monoxide to enter the cab/sleeper and cause death or serious illness.



WARNING! ever idle your vehicle for prolonged periods of time if you sense that exhaust fumes are entering the cab or sleeper. Investigate the cause of the fumes and correct it as soon as possible. If the vehicle must be driven under these conditions, drive only with the windows open. Failure to repair the source of the exhaust fumes may lead to death, injury or personal harm.



NOTES: Keep the engine exhaust system and the vehicle's ventilation system properly maintained. It is recommended that the vehicle's exhaust system and cab be inspected

- by a competent technician every 15,000 miles
- when a change is noticed in the sound of the exhaust system
- if the exhaust system, underbody, or cab is damaged



NOTE: To allow for proper operation of the vehicle ventilation system, keep the inlet grille at the base of the windshield clear of snow, ice, leaves and other obstructions at all times.



NOTE: Do not stay in the vehicle with the engine running or idling for more than 10 minutes with the vehicle's Heater / AC ventilation system in RECIRC or at LOW FAN SPEED. Even with the ventilation system On, running the engine while parked or stopped for prolonged periods of time is not recommended.



NOTE: If you are required to idle your vehicle for long periods of time, install an auxiliary heater or automatic idle control. These auxiliary devices can reduce fuel consumption and save you money.



NOTES: When idling for short periods of time

- *Set the heating or cooling system to Heat or A/C*

- *Set the fan to Medium or High speed*

- *Set the controls to FRESH AIR*



NOTE: If other vehicles are parked next to you idling, move your vehicle or do not stay in your vehicle for prolonged periods of time.

To Set the Heater-Air Conditioning Controls

The cab's control panel may have up to six controls (see illustration below):

- A rotary knob (A) in the upper left portion controlling the blower speed with four settings.
- A rotary knob (B) in the upper center portion controlling the movement of air within the cab. This control is continuously variable through five modes (clockwise from left):
 - Panel
 - Panel/Floor
 - Floor
 - Defrost/Floor
 - Defrost
- A rotary knob (C) in the upper right portion controlling the air temperature.
- A rocker switch (D) in the lower left portion to engage the air conditioner compressor.

- A rocker switch (E) on the lower center portion to send power to the “bunk” or sleeper control panel.
- A rocker switch (F) in the lower right portion to select either fresh or recirculated air mode.

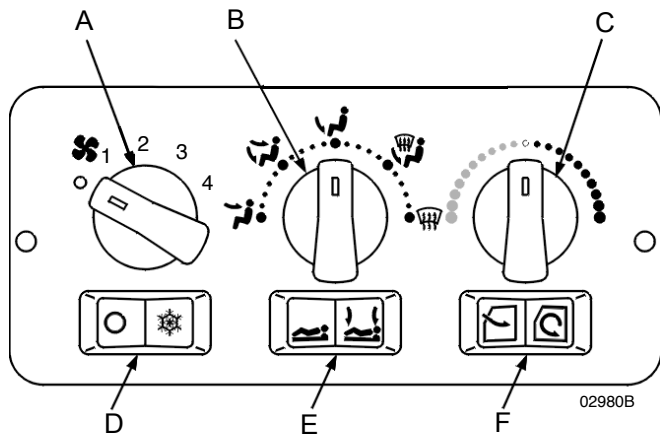

The sleeper control panel will have two controls (see next illustration):

- A rotary knob in the left portion controlling the blower speed with four settings.

- A rotary knob in the right portion controlling the air temperature.

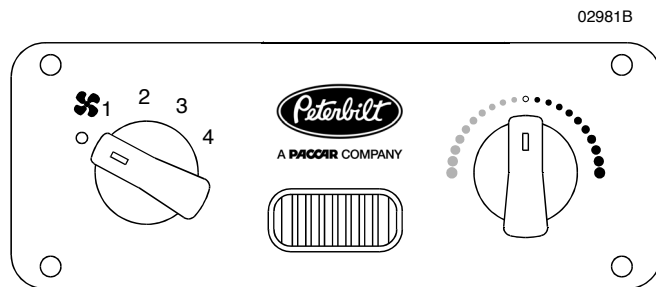

The cab “bunk” control rocker switch must be ON for the sleeper controls to function.

- **To heat the cab**, select the desired air mode and set the temperature knob to hot (the red position on the control) and the blower to whatever speed makes you most comfortable.



WARNING! Do not drive with visibility reduced by fog, condensation, or frost on the windshield. Your view may be obscured, which could result in an accident involving causing death or personal injury. For clear visibility

and safe driving, it is extremely important for you to follow the instructions pertaining to the function and use of the ventilation/heating and defogging/defrosting system. If in doubt, consult your dealer. Maximum heating output and fast defrosting can be obtained only after the engine has reached operating temperature.



CAUTION: During extreme cold weather, do not blow hot defroster air onto cold windshields. This could crack the glass. Turn the air flow control lever to Defrost and adjust the fan speed accordingly while the engine warms. If the engine is already warm, move the temperature selector to Cool, then gradually increase the temperature when you see that the windshield is starting to warm up.

- **To defog the windshield**, select the Defrost mode and turn the blower speed to high. Set the temperature knob to hot (the red position on the control). The air conditioner is automatically activated to remove moisture from the cab. After the windshield is clear, adjust the mode, blower speed, and temperature to your comfort.

- **To cool the cab**, turn on the A/C switch, set the temperature knob to cool (the blue position on the control), and the blower to high until the cab becomes cool. Then you can turn down the blower if you wish.

For Efficient Cooling:

1. Be sure all heater - air conditioner controls are off.
2. Start the engine. Allow time for warm-up.



CAUTION:

- **A cold compressor can cause refrigerant to liquefy and warp the valve plates or cause a hydraulic lock. Warm the engine before starting the air conditioner.**
 - **Turn off all controls when the system is not in use. Doing so will avoid damage to the air conditioning system components.**
3. Set the air control in the RECIRC mode.
 4. Close all windows.
 5. Idle the engine between 1000 and 1500 RPM and turn the blower speed control to high.
 6. After the cab temperature cools to a comfortable level, adjust the blower speed and controls to keep the desired condition.



NOTE: When the air conditioner isn't in regular use, operate it for at least 15 minutes at least once a month or every 5,000 miles (8,000 Km), whichever comes first. This will lubricate the seals in the air conditioning system. The air conditioning system is active when the Defrost mode is selected.

Cigarette Lighter

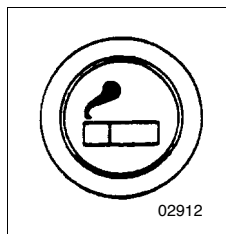

Lighter

To operate your lighter, push the knob in. After a few moments the lighter will automatically pop out, ready to use. After use, insert the knob, but don't push it in. The lighter circuit is protected by a 10-ampere polyswitch to prevent damage should the lighter get stuck in the IN posi-

tion. If this fuse needs replacement, check to ensure that the lighter is not stuck before replacing the fuse.



WARNING! Do not exceed the voltage/ampere capacity of the cigarette lighter. It could result in a fire causing death or personal injury. Follow all warnings and instructions in the operator's manual for the appliance you are using.

The lighter receptacle may be used to power auxiliary equipment that does not draw more than 10 amperes maximum.

Ashtray



WARNING! Paper or other combustible substances in an ashtray could cause a fire resulting in death or personal injury. Keep all burnable materials besides smoking materials out of the ashtray.

Glove Compartment

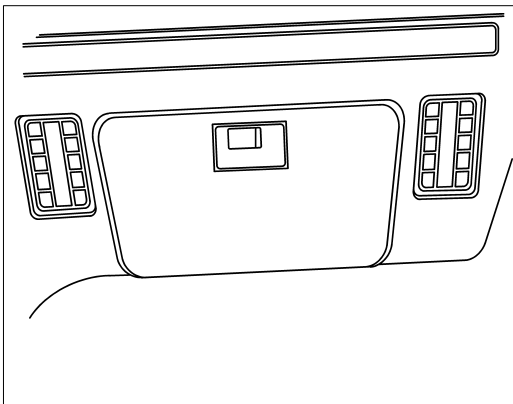

To open your glove compartment, pull the latch. To close it, push the cover up and press to latch it.

The glove compartment can be locked. Turn your glove box key clockwise (right) to lock and counterclockwise (left) to unlock.



WARNING! Do not drive with the glove compartment open, it can be dangerous. In an accident or sudden stop, you or a passenger could be thrown against the cover and be killed or injured. To reduce the risk of death or personal injury during an accident or sudden stop, keep the glove compartment closed when the vehicle is in motion.

Gauges

On the pages that follow you will find descriptions of some of the gauges on your instrument panel. For more information about using them in driving, see [“PART 7: STARTING & OPERATING THE VEHICLE”](#). Also check the Index under the name of the gauge or function you want to know more about.



WARNING! Do not ignore a warning light or audible alarm. These signals tell you something is wrong with your vehicle. It could be a failure in an important system, such as the brakes, which could lead to an accident involving death or personal injury. Have the appropriate system checked immediately.



NOTE: All of the warning lights and alarms for functions monitored by the multiplex instrumentation system instrument system are contained within the individual gauges of the system. The alarms for other controls or systems that you may have will be displayed separately on the instrument panel. They are described further in [“PART 7: STARTING & OPERATING THE VEHICLE”](#) of this manual.

Speedometer

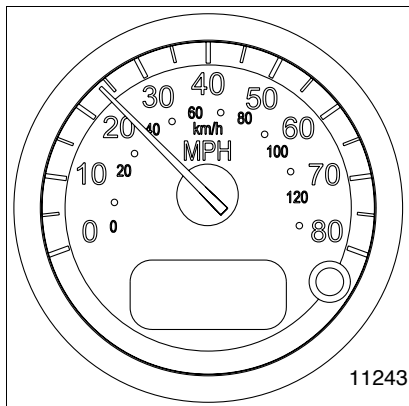

The speedometer indicates the vehicle speed in miles per hour (mph) and in kilometers per hour (km/h). The speed-

ometer also includes an odometer, trip meter, and trip reset button.

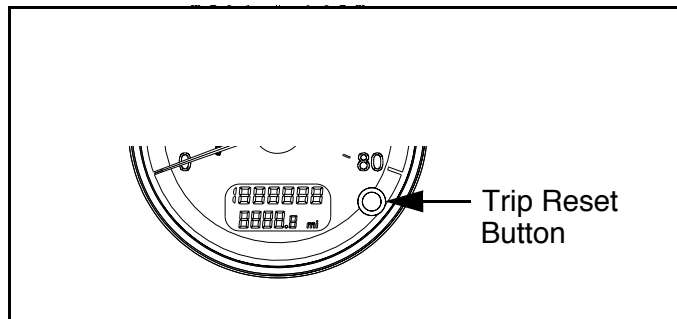

Odometer / Trip Meter

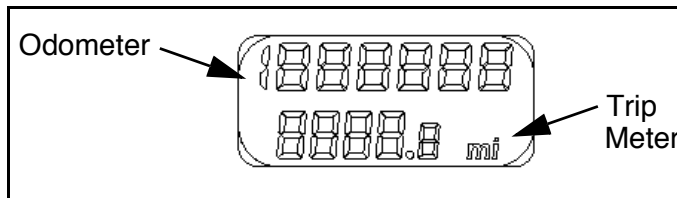

The LCD display in the lower part of the speedometer contains the odometer and trip meter.

The odometer displays the total distance your vehicle has traveled. It will display in miles on an English speedometer

or in kilometers on a metric speedometer. The maximum distance that can be shown on the odometer is “1 999 999” before it rolls over to zero.

The trip odometer displays how far the vehicle has gone on a particular trip. The trip odometer will display in miles on an English speedometer or in kilometers on a metric speedometer, in one tenth divisions. The maximum distance that can be shown on the trip odometer is “9999.9” before it rolls over to zero.

To reset the trip odometer, press and hold the trip reset button on the speedometer. The numbers will reset to 0 and begin to count new miles/km traveled. This also resets the trip values in the Driver Information Display.

The trip reset button also toggles all displays between English and Metric. (See page 62.)



NOTE: The Odometer/Trip Meter comes on when the door is opened or the key is in the accessory or ignition position. The Odometer/Trip Meter will remain on for 3 seconds after the door is closed or the ignition switch is turned off. This allows driver and service personnel to read the odometer without ignition switch being turned on.

Tachometer

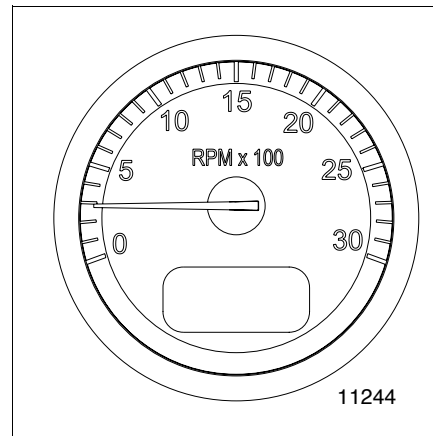

Your tachometer measures the engine speed in revolutions-per-minute (RPM). The tachometer also includes an engine hour meter and outside air temperature display.

Watching your tachometer is important to driving efficiently. It will let you match driving speed and gear selection to the operating range of your engine. If your engine speed gets too high, you can select a higher gear to lower the RPM. If your engine speed drops too low, you can select a lower gear to raise the RPM.

Engine Hours / Outside Air Temperature

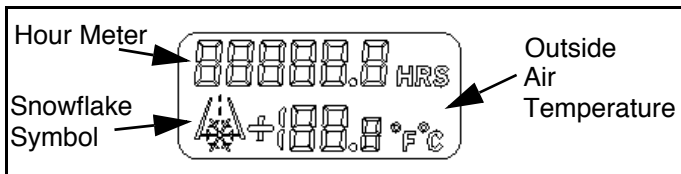

The LCD display in the lower part of the tachometer contains the engine hour meter and the outside air temperature display.

The engine hour meter will display the total number of hours the engine has been running. The maximum hours that can be shown are “99999.9” before the meter rolls over to zero.

The outside air temperature (OAT) will display the temperature outside the vehicle. The temperature can be displayed from -40° to 158° in Fahrenheit or -40° to 70° Celsius. The display will also alert the driver when the outside temperature approaches freezing (32°F or 0°C) by displaying a snowflake symbol. The symbol will turn on when the temperature drops below 34°F or 11°C and flash for the first 3 seconds, then stay on until the temperature goes above 37°F or 28°C.

The temperature can display using Standard or Metric units. Press the trip reset button on the Speedometer 4 times within 4 seconds. This will also change the units shown by the Driver Information Display.

Refer to “To Set Units of Measure:” on page 35 for another method to change units.



NOTE: The OAT will come on when the door is open and the key switch is in the accessory or ignition position. The OAT display will turn off when the ignition switch is turned off.



NOTE: The OAT uses a sensor (located at the bottom of the driver’s side mirror assembly) to measure outside air temperature only. It is not capable of displaying the temperature of the road surface on either the temperature display or the snowflake icon.



NOTE: The effects of direct sunlight, or the use of mirror heat, will increase the outside air temperature displayed while the vehicle is stationary.

Air Application Gauge

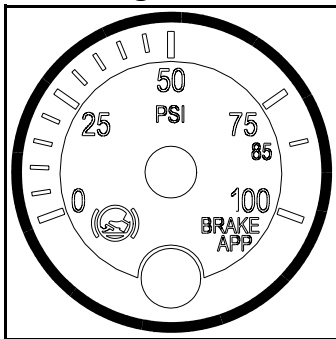

This gauge will show you how much air pressure is being applied from your foot brake valve or trailer brake hand valve.

Primary (Secondary) Air Pressure Gauge (Air Reservoir)

The air pressure gauge indicates the amount of air pressure in the brake system in pounds per square inch (psi).

- The primary gauge shows front reservoir air pressure.
- The secondary gauge shows pressure in the rear reservoir.

Ensure the air pressure registers more than 100 psi in both service systems before you move the vehicle. If the pressure in either circuit is too low for normal brake operation, the warning light will glow and the audible alarm will sound.

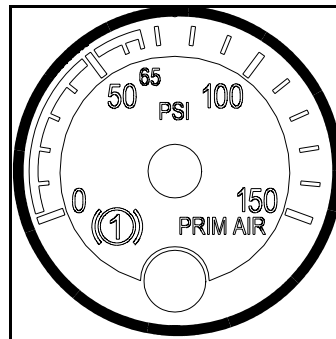

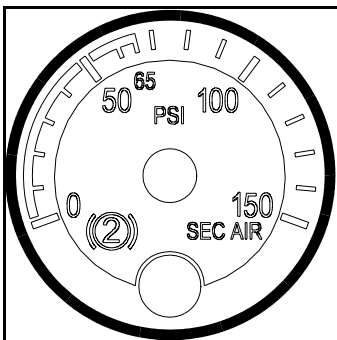

WARNING! *The air pressure warning light and the audible alarm indicate a dangerous situation. There is not enough air pressure in the reservoirs for repeated braking and the brake system has failed. If air pressure falls below 60 psi (414 kPa) the spring brakes could suddenly apply, causing a wheel lockup, loss of control, or your vehicle to be overtaken by following vehicles. You could be in an accident and severely injured or killed. If these alarms come on while you are driving, bring your vehicle to a safe stop right away. If the light and alarm do not turn off at start-up, do not try to drive the vehicle until the problem is found and fixed.*

Engine Oil Pressure Gauge

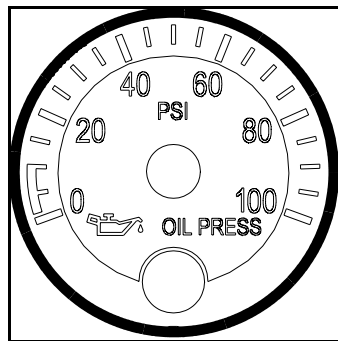

It is important to maintain oil pressure within acceptable limits. Your engine manual will give you normal operating pressures for your particular engine.



CAUTION: *Continuing to operate your vehicle with in-sufficient oil pressure will cause serious engine damage.*

- If your oil pressure fails to rise within 10 seconds after your engine starts, stop the engine and determine the cause.

- If your oil pressure suddenly drops while you are driving, bring the vehicle to a stop as soon as possible in a safe location off the road and turn off the engine. Wait a few minutes to allow oil to drain into the oil pan, and then check the oil level. Add oil if necessary. If the problem persists, contact an authorized service center.

Water Temperature Gauge

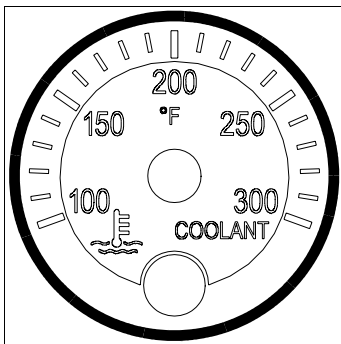

The water temperature gauge shows the temperature of the engine coolant. Under normal operating conditions the water temperature gauge should register between 165° and 205°F (74° and 90°C). Under certain conditions, somewhat higher temperatures may be acceptable. But

the maximum allowable temperature is 210°F (99°C) with the cooling system pressurized, except for certain special engines. Check your engine manual to be sure.

Engine Overheating



WARNING! Do not remove the radiator fill cap while the engine is hot. Scalding steam and fluid under pressure may escape and cause death or personal injuries.

- Wait until the coolant temperature is below 122°F (50°C).
- Protect face, hands, and arms by covering the cap with a large, thick rag to protect against escaping fluid and steam.
- Carefully and slowly turn the cap one-quarter of a turn or until it reaches the first stop (allowing excess pressure to escape) push down and turn for final removal.

Wait until the coolant temperature is below 122° F (50° C). Protect your face, hands, and arms by covering the cap with a large, thick rag to protect you against escaping fluid and steam. Before you completely remove the cap, carefully and slowly turn the cap part way to allow excess

pressure to escape. Then push down and turn for final removal.

The cooling system may overheat if the coolant level is below normal or if there is a sudden loss of coolant (such as a worn hose splitting). It may also temporarily overheat during severe operating conditions such as climbing a long hill on a hot day or stopping after high-speed driving.

If the “Engine Coolant Temperature” warning light comes on, or you have any other reason to suspect the engine may be overheating:

- Stop the vehicle, but **DON'T TURN OFF THE ENGINE** unless a low water warning device indicates a loss of coolant.
- With the transmission in neutral, check to be certain the oil pressure gauge reads normal. Increase the engine speed to about 1100 - 1200 RPM, maximum. Return the idle speed to normal after 2 or 3 minutes. If the warning light doesn't go off or the temperature gauge doesn't begin to drop, then turn the engine off.

If the overheating came from severe operating conditions, the temperature should have cooled by this time. If it has

not, stop the engine and let it cool before checking to see if the coolant is low.

Fuel Gauge

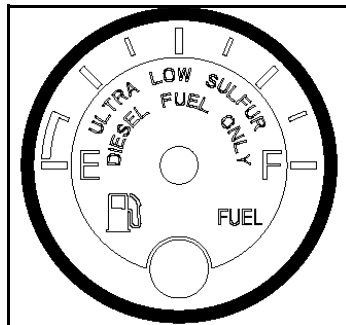

WARNING! Do not remove a fuel tank cap near an open flame. Fuel vapors are combustible and can cause an explosion or fire resulting in injury or death.



WARNING! Do not breathe diesel fumes as exposure to diesel fumes may cause respiratory illness, personal injury or death.



CAUTION: Use Ultra Low Sulfur Diesel fuel only. Failure to do so may damage the engine and components of the Diesel Particulate Filter (DPF).

The fuel gauge shows the approximate amount of fuel in the fuel tanks. Besides empty and full, the gauge also indicates 1/4, 1/2, and 3/4 of total capacity. You will want to keep your fuel tanks at least half full to reduce condensation of moisture in the tanks. This moisture can damage your engine.



WARNING! Carrying additional fuel containers in your vehicle is dangerous. Full or empty, they may leak, explode, or cause a fire which may lead to death or personal injury. Don't carry extra fuel containers - even empty ones.

Diesel Exhaust Fluid (DEF) Gauge

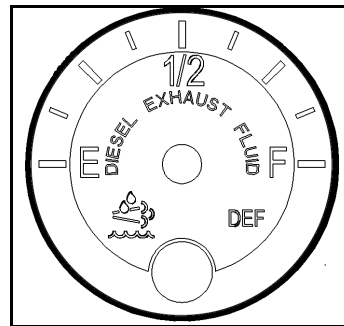

The diesel exhaust fluid gauge shows the approximate amount of DEF fluid in the DEF tank. Besides empty and full, the gauge also indicates 1/4, 1/2, and 3/4 of total capacity. DEF fluid is required to meet certain emission requirements. Do not allow your DEF tank to remain empty. Please refer to your emission supplemental manual for more details about DEF fluid.



Use Diesel Exhaust Fluid only. Failure to do so may damage components of the Diesel Particulate Filter (DPF).

Transmission Temperature Gauge

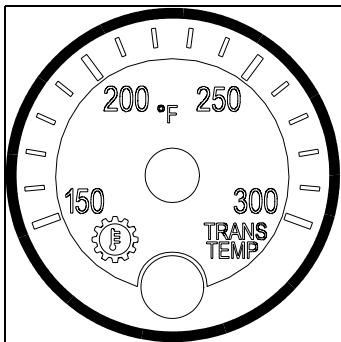

Your Transmission Temperature Gauge indicates the temperature of the oil in your transmission. Watch this gauge to know when your transmission is overheating. If it is, have it checked by an authorized service representative.

Maximum transmission temperature may vary, depending upon the transmission and type of lubricant. Check your transmission's owner's manual.

Front Drive Axle or Rear Drive Axle Temperature Gauge

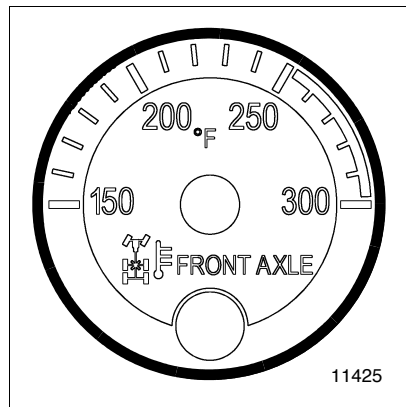

CAUTION: Driving with very hot temperatures in your rear drive axles can cause serious damage to axle bearings and seals. Check axle lubrication if a driver temperature alarm sounds.

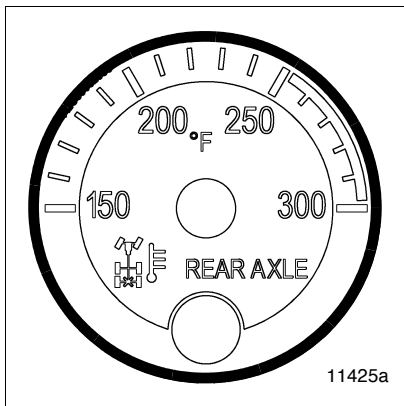

These gauges indicate the temperature of the lubricant in your vehicle's axle(s). These temperatures will vary with the kind of load you are carrying and the driving conditions you encounter. Maximum axle temperature may vary, depending upon the axle and type of lubricant. Very high temperatures signal a need to have your axle(s)' lubrication checked.

Manifold Pressure Gauge

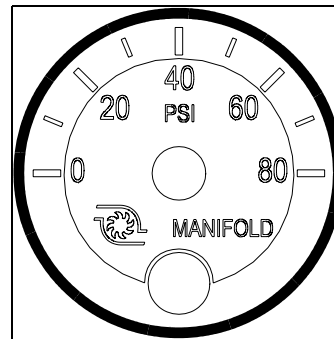

Your manifold pressure gauge indicates the power your engine is putting out by showing the amount of turbo boost. If the pressure indicated by your manifold pressure gauge goes down, there may be something wrong with your engine. Have it checked by a qualified service person.

Voltmeter

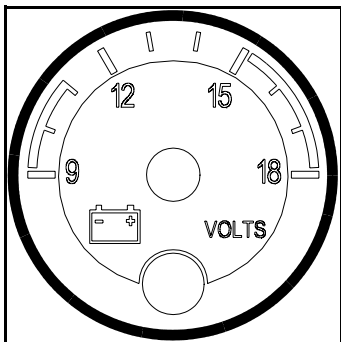

The voltmeter displays the voltage at which your batteries are being charged while the engine is operating.



NOTE: Even with a healthy charge/start system, the voltmeter may fall well below 12V during engine cranking. If voltage drops below 12V and stays there, have the electrical system checked.

Air Filter Restriction Indicator Gauge

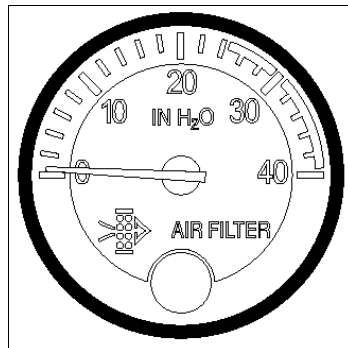

This gauge indicates the condition of the engine air cleaner and is measured by inches of water (H₂O). A clean filter should register 7 in. H₂O (may vary with system design) and a filter whose life is over will register approximately 25 in. H₂O.



CAUTION: *Continued operation with the Air Filter Re-striction Gauge reading 25" H₂O may cause damage to the engine. Inspect the filter and replace if necessary. Holes in the paper element render an air cleaner useless and may cause the Air Filter Restriction Gauge to give a false reading, even if the element is clogged. Replace the element if it is damaged.*

Shift Pattern Display

The correct shift pattern for your vehicle appears on your control panel, windshield or on a medallion in the shift knob. It is important that you know more about your transmission than just the shift pattern. Please read the manufacturer's manual that is included with your vehicle.

Mirrors



WARNING! *Convex mirrors can distort images and make objects appear smaller and farther away than they really are. You could have an accident resulting in death or personal injury if you are too close to another vehicle or other object. Keep plenty of space between your vehicle and others when you turn or change lanes. Remember that other objects are closer than they may appear.*

Your vehicle is equipped with outside mirrors to enable you to see to the sides and behind your vehicle. Be sure they are adjusted properly before you drive off. You will have the best field of view to the side if you adjust each mirror so you can just see the side of your vehicle in the inboard part of the mirror.

Luggage Compartment(s)

An interior luggage compartment is under the bunk in the sleeper. The exterior compartment is beneath the bunk, opening from the driver's side, on the outside of the cab.



WARNING! *Carrying objects loose in your cab or sleeper can be dangerous. In a sudden stop, or even going over a bump, the object could fly forward and strike you or a passenger, possibly causing death or serious injury. Secure loose objects. Carry any heavy objects in the exterior luggage compartment and close it securely.*



WARNING! *Do not store combustible materials in the luggage compartment. They may leak and, if ignited, cause or fuel a fire which may lead to death or personal injury.*

Appliances in the Cab

You may decide to equip your vehicle with a radio, a refrigerator, or other appliances and conveniences. Be sure they are compatible with your truck's electrical system. Secure them in the cab so they can't fly loose in a sudden stop.



WARNING! *In a sudden stop or collision a heavy object in your cab could strike you or anyone with you. You could be injured or killed. Secure any appliance (such as a refrigerator or radio) you add to your cab.*

Refrigerator

Follow the procedure below to operate the refrigerator.



CAUTION: *Leaving your refrigerator on when the vehicle's engine is not running will rapidly run down your vehicle's batteries. This may cause premature battery failure.*



NOTES:

• *For additional information about the refrigerator, refer to the refrigerator owner's manual that came with this appliance.*

• *Refrigerator cooling ability decreases as sleeper temperature increases.*

The main power supply to the refrigerator and cooling fan (located behind the refrigerator) is controlled by a switch labeled "REFRIG/FAN" located on the sleeper control panel.

- To turn the refrigerator and cooling fan on, move the REFRIG/FAN switch to ON, then turn the thermostat dial (located inside the refrigerator) clockwise from the OFF setting.
- To turn the refrigerator and cooling fan off, turn the thermostat dial inside the refrigerator counterclockwise to the OFF setting, then move the REFRIG/FAN switch to OFF.
- To turn only the refrigerator off, turn the thermostat dial counterclockwise to OFF.

Peterbilt Navigation System

Your vehicle may be equipped with a Peterbilt Navigation System. This system is a Global Positioning Satellite (GPS)-linked computer. It receives input from multiple sources to locate your vehicle. Read and understand the Supplemental Navigation System Owner's Manual and observe the Warnings, Cautions, and Notes that follow before using the system.



WARNING! Verify legal weight and height restrictions for the route suggested by the Navigation System. Failure to verify height restrictions could lead to death or personal injury. Failure to verify weight restrictions could also result in a traffic infraction.



WARNING! Only glance at the Navigation System monitor while driving. Prolonged periods of viewing while driving could result in an accident and death or possible personal injury.



WARNING! Do not program the Navigation System while driving. Always stop your vehicle when programming or changing the settings on the Navigation System. Programming the system while driving can cause you to take your eyes off the road, which could result in an accident. Failure to do so could lead to death, serious injury or equipment damage.



CAUTION: Do not rely on the Navigation System to route you to the closest emergency services. Not all emergency services are in the database.



NOTE: Regardless of how and where the navigation system directs you, it is your responsibility to operate the vehicle in a safe and legal manner.



NOTE: Ensure the volume level of all audio devices is set to a level that still allows you to hear outside traffic and emergency vehicles.



NOTE: The map database is the most current available at the time of production. The database is designed to provide you with route suggestions and does not take into account the relative safety of a suggested route or of factors that may affect the time required to reach your destination. See the Supplemental Navigation System Owner's Manual for more information.

PART 5: SEAT AND RESTRAINT SYSTEMS

Seat

For information on the features and adjustment of the seat, see the seat manufacturer's literature included with the vehicle.



WARNING! Do not drive or ride with your seat back in the reclined position. You could be injured or killed by sliding under the seat belts in a collision.



WARNING! Do not adjust the driver's seat while the vehicle is moving. A sudden or unexpected seat movement can cause the driver to lose control of the vehicle causing death or personal injury. Make all adjustments to the seat while the vehicle is stopped.

- ***After adjusting the seat and before driving off, always check to be sure that the seat is firmly latched in position.***

Seat Belts And Their Proper Use

Seat (or safety) belts have proven to be the single most effective means available for reducing the risk of serious injury and death in motor vehicle accidents. It's not just an opinion -- it's a fact: Seat belts save lives.



WARNING! Do not drive vehicle without your seat belt and your riders' belts fastened. Riding without a safety belt which is properly fastened can lead to increased death or injury in an accident. Unbelted riders could be thrown into the windshield or other parts of the cab or could be thrown out of the cab. They could strike another person. Injuries can be much worse when riders are unbelted. Always fasten your seat belt and be sure anyone riding with you does the same.

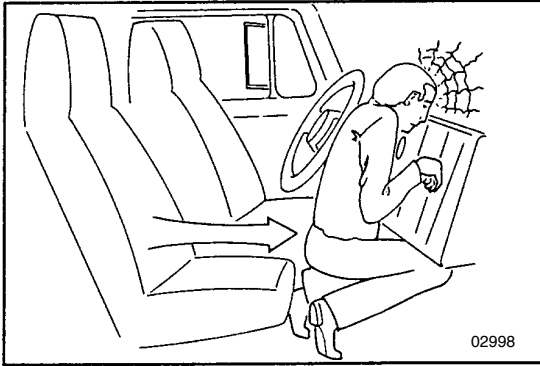

Person In Crash, Unbelted

Shoulder Belt

Your combination shoulder-lap belt needs proper adjustment:

- The lap portion should be worn as low on the hips as possible

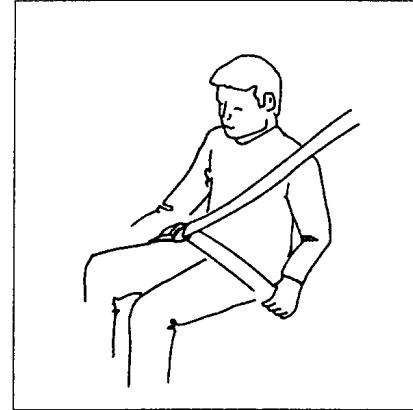

Properly worn belt

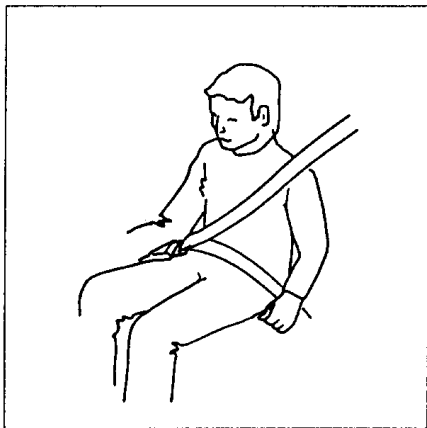

Improperly worn belt

The shoulder portion should fit snugly across your body. It should always be worn over the shoulder next to the door. If you put the belt under your arm, it can't protect you properly



WARNING! Always wear your seat belt low over your pelvic bones.

- You can be killed or seriously injured if your belt is buckled too high. In a crash, it would apply force to your abdomen, not your pelvic bones. This can result in death or serious internal injuries.

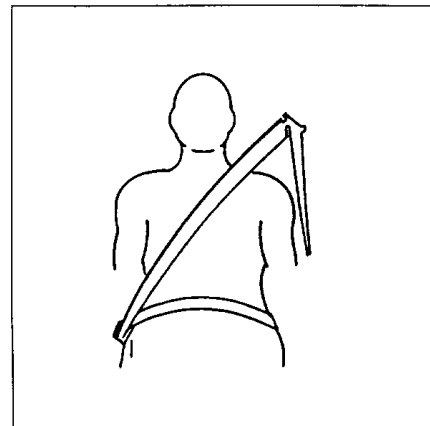

Correct (over arm)

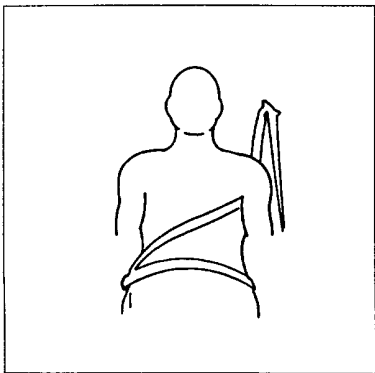

Incorrect (under arm)



WARNING! Do not wear the shoulder belt under your arm or otherwise out of position. In a crash your body would move too far forward, increasing the chance of death or head and neck injury. Also, the belt would apply too much force to the ribs, which are not as strong as your shoulder bones, and could cause you to suffer internal injuries. Wear the shoulder belt over your shoulder.



WARNING! Do not drive with your seat belt loose. A seat belt that is too loose can allow you to fall too far forward, possibly causing head and neck injuries, resulting in death or personal injury. You could strike the wheel or the windshield. Adjust your belt so that there is no more than 1 in. (25mm) of slack.

Watch that you don't twist the belt in the process of putting it on. A twisted belt won't work as well to protect you.

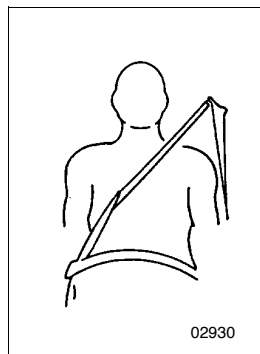

Twisted Belt



WARNING! Do not twist the belt in the process of putting it on. A twisted belt will not work as well to protect you. In a crash, the full width of the belt would not be protecting you. A twisted belt could cut into your body and cause death or serious injuries. Straighten the belt before buckling it. If you are unable to wear it without twisting it, have your dealer or service person repair it as soon as possible

To connect your shoulder-lap belt: Grasp the belt tongue and pull in a smooth, slow motion across your chest and lap. Insert the tongue into the buckle on the inboard side of the seat. Push down until you hear a click. Pull on the belt to make sure it is buckled. Check that it is positioned correctly on your body.

Komfort-Lok® Feature

Your Peterbilt contains a feature designed to eliminate cinching and provide improved safety and comfort. Cinching is the condition where a belt becomes continually tighter around you during a rough, bouncy ride. The need for this feature increases with rough road conditions, particularly over long distances.

To eliminate cinching simply activate the comfort feature at the appropriate time:

1. Fasten your seat belt according to the directions.
2. You are now ready to activate the Komfort-Lok. Lean forward to pull a little slack (about 1 inch) in the belt. Be sure to allow only a small amount of slack. See the Warning on a loose belt, on the previous page.
3. When the slack is right, slide the comfort feature up. When the slack is right, flip the latch cover up, cinching it into place. This locks the Komfort-Lok.
4. To release the Komfort-Lok latch, reach up and pull the latch cover open (down), or simply pull down on the shoulder belt.
5. When you want to get out of the cab, release the latch, then just push the button on the buckle.

Pregnant Women: Sometimes pregnant women worry that in a crash the seat belt could hurt the baby. But if a woman wears her belt properly - low over her pelvis, below her abdomen - the belt won't harm the baby, even in a crash. And remember - the best way to keep an unborn baby safe is to keep the mother safe.

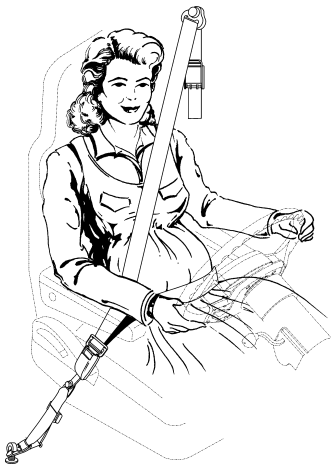

Pregnant Woman With Belt Properly Worn

Sleeper Bunk Restraints

If your cab is equipped with a sleeper, be sure to use the restraint device. You may have belts which either are over the bunk or cover the opening. Of course, you do not need to use a restraint if you sleep in a parked vehicle. But anyone using the sleeper while the truck is in motion should be restrained in a safety device.



CAUTION: To avoid damage when lifting a bunk, remove all items from the top of the bunk mattress, and arrange bedding so that items will not slide down the mattress and fall behind the bunk.

The bunk restraint is attached to the sleeper in six locations (see illustration below):

1. Two buckles at the upper rear wall
2. Two buckles at the side walls
3. Bolts in two places at the lower rear wall

There is also a buckle at the driver's side front of the bunk for easy entry/exit of the sleeper with the bunk restraint in use.

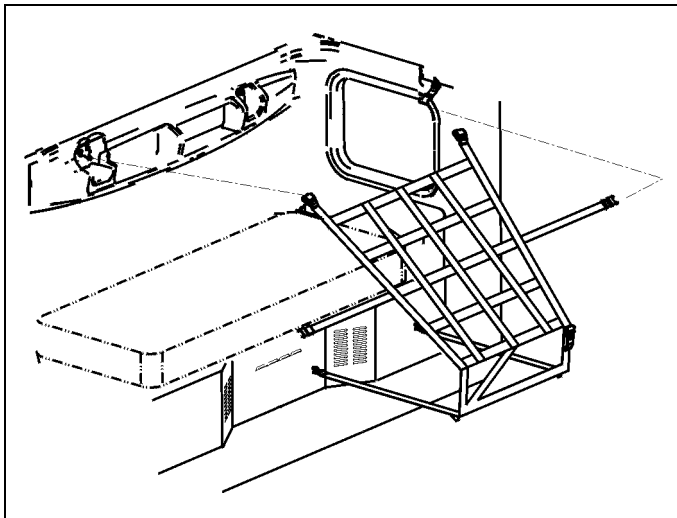

- The upper rear wall: Access to the bunk is easiest when these connections are buckled and the front buckle is detached.
- The side walls: The tenting straps are attached to the side wall sills with easy-to-use buckles.

- The lower rear wall: The restraint is attached to the lower rear wall by bolts that do not require removal for use or stowage of the bunk restraint.

You will notice that if your Peterbilt has an upper bunk, it has no restraint device. This is because no one should ever be in an upper bunk when the vehicle is moving.



WARNING!

- ***In an accident an unrestrained person lying in a sleeper bunk could be killed or seriously injured. He or she could be thrown from the bunk. Be sure anyone occupying the sleeper is restrained while a vehicle is moving.***
- ***Be sure that no one ever rides in the upper bunk while the vehicle is in motion. That person would be thrown out in an accident and could be killed or seriously injured.***

Passengers

Anyone riding in your vehicle should wear a seat belt. The responsible operator sees to it that everyone in the vehicle rides safely - and that means with a seat belt.

Some Other Safety Restraint Tips:

- Don't wear belts over rigid or breakable objects in or on your clothing. Such things might be eyeglasses, pens, keys, etc. These could cause injury in an accident.
- Damaged belts in the cab or sleeper must be replaced. Belts that have been stretched, cut, or worn out may not protect you in an accident.
- Avoid catching belts in the doors or seat hardware. They could be damaged.
- Don't modify or disassemble the seat belts in your vehicle. They won't be available to keep you and your passengers safe.

- Never bleach or dye seat belts; chemicals can weaken them. Do, however, keep them clean by following the care label on the belts. Let them dry completely before allowing them to retract.
- If any seat belt is not working properly, see an authorized Peterbilt dealer for repair or replacement.

Tether Belts

Tether belts are installed on suspension seats. They help secure the seat to the floor to restrain it in case of a sudden stop or an accident.



WARNING! Do not remove, modify, or replace the tether belt system with a different tether system. A failed or missing tether belt could allow the seat base to fully extend in the event of an accident leading to greater injuries or death.

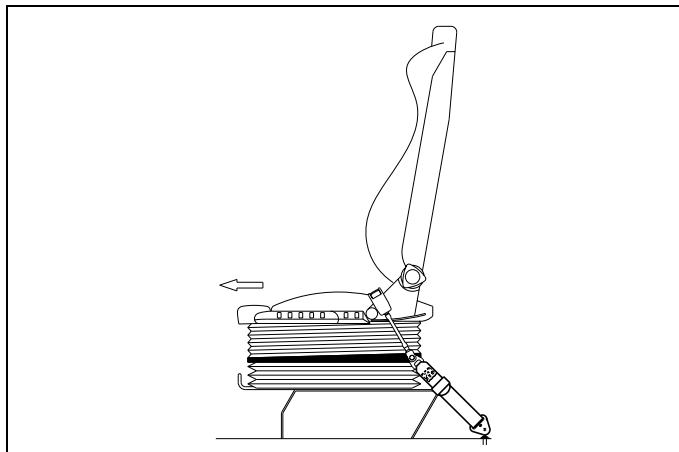

Tether Adjustment



WARNING! Failure to adjust tether belts properly can cause excessive movement of the seat in an accident. This could lead to death or greater injuries to you. Tether belts should be adjusted so that they are taut when the seat is in its most upward and forward position.



WARNING! Before driving or riding in a vehicle, ensure that there is adequate head clearance at maximum upward travel of seat. Shorten the tether belt as necessary to provide adequate head clearance. Death or serious injury may occur if head clearance is not adequate.

Make sure the tether belt is attached to the cab deck and seat frame. It should be routed through the buckle on each side.

To lengthen the tether, turn the buckle to a right angle to the webbing. Then pull the buckle. To shorten the tether, pull on the strap.

Inspection of the Restraint System



WARNING! Failure to properly inspect and maintain restraint systems can lead to serious injury or loss of life. Without periodic inspection and maintenance to detect unsafe conditions, seat restraint components can wear out or not protect you in an accident.

The typical three-point seat systems in passenger cars may seem very similar to the three-point seat belt system in heavy duty vehicles, but there are some key differences that all users of this system should be aware of:

- In typical passenger vehicle automotive seat belt applications, the normal life of the vehicles is usually 8 to 10 years and the total mileage frequently does not exceed 125,000 miles (200,000 km). Heavy duty vehicles often see this type of mileage in a very short period of time, and accumulation of mileage in excess of 500,000 miles (800,000 km) during the vehicle lifetime is not unusual.
- A significant difference in the two systems is the amount of movement of webbing in the system. In an automotive application, there is little movement of the seat belt system, except when the user puts on or takes off the belt. In trucks, however, there is almost constant movement of the belt through hardware due to ride characteristics and seats which are designed to move, in order to enhance driver comfort. There can even be movement of the webbing in the seat belt system when the belt is not being used. Relative

movement between the seat and the cab, which normally occurs whenever the truck is in operation, can cause wear of the seat belt webbing.

- Environmental conditions represent another major difference in the systems in automobiles and heavy duty and specialty vehicles. Unlike the automotive environment, heavy duty and specialty vehicles may be very dirty, and have more exposure to the sun's damaging ultraviolet rays, thus resulting in a reduction of the life of the seat belt system.

The high mileage associated with heavy duty vehicles and possible wear of the 3-point seat belt system, the continual relative movement of the system, the possible contact with the vehicle seat or other parts of the cab structure, and the potential exposure of this system to severe environmental conditions make it crucial to inspect the three-point seat belt systems regularly.

It is recommended that the seat belt system in a vehicle be inspected every 20,000 miles (32,000 km) or more often if the vehicle is exposed to severe environmental conditions. Any seat belt system that shows cuts, fraying, extreme or unusual wear, significant discoloration due to UV exposure, abrasion to the seat belt webbing, or dam-

age to the buckle, latch plate, retractor hardware or any other obvious problem should be replaced immediately, regardless of mileage.



WARNING! *It is important to remember that any time a vehicle is involved in an accident, the entire seat belt system must be replaced. Unexposed damage caused by the stress of an accident could prevent the system from functioning properly the next time it is needed, which could result in severe injury or even death.*

One of the most critical areas to be inspected is the seat belt webbing. Constant movement of the belt actually means the webbing is experiencing wear as it travels in and out of the retractor, through the pillar loop web guide and through the various pieces of hardware associated with the belt. The following guidelines detail how to inspect for cuts, fraying, extreme or unusual wear of the webbing, etc. and damage to the buckle, retractor, hardware, or other factors which indicate that belt replacement is necessary.

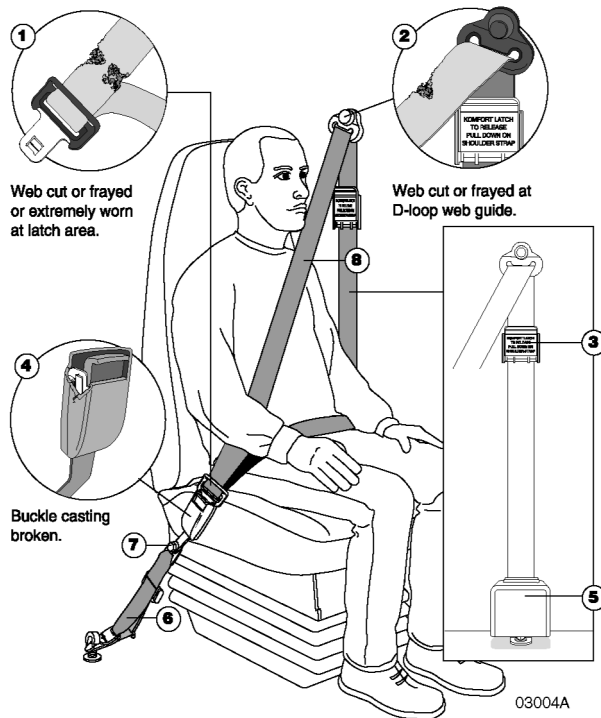

1. Check the web wear in the system. The webbing must be closely examined to determine if it is coming into contact with any sharp or rough surfaces on the seat or other parts of the cab interior. These areas are typical places where the web will experience cutting or abrasion. Cuts, fraying, or excessive wear would indicate the need for replacement of the seat belt system.
2. The D-loop web guide is the area where almost constant movement of the seat belt webbing occurs because of relative movement between the seat and the cab.
3. Check the comfort feature for cracks or possible damage and that it works properly.
4. Check the buckle and latch for proper operation and to determine if the latch plate is worn, deformed, or damaged.
5. Inspect the retractor web storage device, that is mounted on the floor or B-pillar of the vehicle for damage. The retractor is the heart of the occupant restraint system and can often be damaged if abused,

even unintentionally. Check retractor web storage device operation to ensure that it is not locked up and that it spools out and retracts webbing properly.



WARNING! Failure to adjust tether belts properly can cause excessive movement of the seat in an accident. This could lead to death or serious injury. Tether belts should be adjusted so that they are taut when the seat is in its most upward and forward position.

6. If adjustable tethers are being used, be sure they are adjusted in accordance with installation instructions. Tethers must also be inspected for web wear, just as with the seat belt systems.
7. Mounting hardware should be evaluated for corrosion, and for tightness of bolts and nuts.
8. Check web in areas exposed to ultraviolet rays from the sun. If the color of the web in these areas is gray to light brown, the physical strength of this web may have deteriorated due to exposure to the sun's ultraviolet rays; replace the system.



WARNING! Replace the entire belt system (retractor and buckle side) if replacement of any one part is necessary. Unexposed damage to one or more components could prevent the system from functioning properly the next time it is needed, which could result in severe injury or even death.

If the inspection indicates that any part of the seat belt system requires replacement, the entire system must be replaced, both retractor and buckle side. An installation guide is attached to every replacement belt. This set of instructions is entitled “**THREE-POINT SEAT BELT INSTALLATION GUIDE.**” There are separate seat belt instruction guides for suspension and fixed bench seats. Use the proper guide for your type of seat, and follow the

instructions very closely. It is vitally important that all components must be remounted back in the same position as the original components that were removed. This will maintain the design integrity of the mounting points for the seat belt assembly.

Once the need for replacement of the seat belt has been determined, be certain that it is only replaced with the recommended replacement seat belt. The occupant restraint system has been developed and tested specifically for this vehicle. If the vehicle was originally equipped with a lap belt, it cannot be replaced with a three-point shoulder harness system, because the cab mounting points are not structurally designed for a three-point seat belt.

PART 6: DRIVER'S CHECKLIST

Safe Vehicle Operation

To keep your vehicle in top shape, and to maintain its high level of safety for you, your passengers, and your load, make a thorough inspection every day before you drive. You'll save maintenance time later -- and the safety checks could help prevent a serious accident. Please remember, too, that Federal law requires a pre-trip inspection and so do commercial trucking companies.

For more information, you can refer to Federal Motor Carrier Safety Regulation 392.7 which tells you that interstate commercial motor vehicles are not to be driven unless the driver is sure that certain parts and accessories are in working order.

You aren't expected to become a professional mechanic. The purpose of your inspections is to find anything that might interfere with the safe and efficient transportation of

yourself and your load. If you do find something wrong and can't fix it yourself, please have a qualified mechanic fix it right away.

For your safety, as well as those around you, be a responsible driver:

- If you drink, do not drive.
- Do not drive if you are tired, ill, or under emotional stress.

Much has gone into the manufacturing of your Peterbilt, including advanced engineering techniques, rigid quality control, and demanding inspections. These manufacturing processes will be enhanced by you—the safe driver—who observes the following:

- knows & understands how to operate a vehicle and all its controls
- maintains the vehicle properly
- uses driving skills wisely



WARNING! Do not drink and drive. Your reflexes, perceptions, and judgment can be affected by even a small amount of alcohol. You could have a serious—even fatal—accident if you drive after drinking. Please do not drink and drive or ride with a driver who's been drinking.

- ***The use of alcohol, drugs, and certain medications will seriously impair perception, reactions, and driving ability. These circumstances can substantially increase the risk of an accident and death or serious personal injury.***

The daily checks listed below are the foundation of your overall preventive maintenance program. See [“PART 8: MAINTENANCE AND SERVICE”](#) for the complete preventive maintenance schedule for your vehicle.

Approaching the Vehicle

1. Check the overall appearance and condition. Are windows, mirrors, and lights clean and unobstructed?
2. Check beneath the vehicle. Are there signs of fuel, oil, or water leaks?

3. Check for damaged, loose, or missing parts. Are there parts showing signs of excessive wear or lack of lubrication? Have a qualified mechanic examine any questionable items and repair them without delay.

Checking Under the Hood or Cab

With the engine stopped:

1. Check the engine oil level; top up as necessary. Refer to your engine's operating manual for the type of oil to use.
2. Check the engine coolant level while the engine is cold. Top up as necessary with premixed coolant. Refer to the instructions on [page 193](#) for adding coolant to the proper level.
3. Check the engine belts. Refer to the instructions on [page 210](#) to check belt condition and adjust tension.
4. Check brake lines and hoses.
5. Check all other accessories, controls, belts, hoses, and wiring for condition and adjustment.
6. Check the windshield washer fluid level; top up as necessary.

7. Check the power steering fluid reservoir; top up as necessary.
8. Check the steering components (pitman arm, draglink, power steering hoses, etc.)
9. Drain the fuel/water separator.

Checking the Luggage Compartment

1. Check the fire extinguisher charge.
2. Check the road emergency kit. Is it complete?



WARNING! Do not store combustible materials in the luggage compartment. They may leak and, if ignited, cause or fuel a fire which may lead to death or personal injury.

Checking Outside the Vehicle

1. Be sure all wheel studs and cap nuts are secure. Check wheel cap nut torque weekly; refer to the instructions on [page 185](#).
2. Check tires for condition and proper inflation.
3. Check the front wheel bearing lube level.

4. Check parking (spring) brakes as to the condition and tightness of air lines, breathers, clamp rings & bolts, mounting studs, and release bolts.
5. Check turn signal operation.
6. Check emergency flashers and exterior lamps.
7. Check the fuel tanks. Is there enough fuel? Are the tank caps secure?



WARNING!

- **Diesel fuel in the presence of an ignition source (such as a cigarette) could cause an explosion. You could be killed or seriously injured. A mixture of gasoline or alcohol with diesel fuel increases this risk of explosion. Use only the fuel recommended for your engine.**
- **Fuel vapors are combustible and can cause an explosion or fire resulting in injury or death. Do not remove a fuel tank cap near an open flame.**
- **Do not breathe diesel fumes as exposure to diesel fumes may cause respiratory illness, personal injury or death.**

8. Visually inspect the fuel tank mounting hardware. Are the tank straps tight? Is the webbing in place?
9. Check the air cleaner and exhaust system. Are they tight and secure?
10. Check the trailer connections. Are they secure and the lines clear? If they are not being used, are they stored properly?
11. Is the trailer spare wheel secure? Inflated?
12. Is the landing gear up and the handle secured?
13. Check the 5th wheel. Is the kingpin locked?
14. Is the sliding 5th wheel locked?
15. Check for loose or missing suspension fasteners.
16. Check springs or other suspension parts for damage such as cracks, gouges, distortions, bulges, or chafing.
17. Check the air system. Are there leaks?

18. Drain excess moisture from all air supply tanks. Make sure the drain valves are closed. This procedure is also required for air supply tanks equipped with automatic drain valves.

In-Cab Checklist



WARNING! To avoid death or injury while entering or leaving the cab, keep your feet in contact with the steps and your hands on the handhold. Always have three points of contact as you enter or exit a cab. See [“PART 2: GETTING INTO & OUT OF THE CAB AND FRAME ACCESS”](#) of this manual for more information.

1. Adjust the seats.
2. Fasten and adjust safety restraint belts. See [“PART 5: SEAT AND RESTRAINT SYSTEMS”](#), or the Index, under Restraint Systems.
3. Sleeper Restraints: Check and inspect condition. See [“PART 5: SEAT AND RESTRAINT SYSTEMS”](#), or the Index, under Restraint Systems.
4. Adjust the steering column.

5. Check mirror adjustment.
6. Operate air-powered devices to circulate lubricants.



*NOTE: The above items should be checked daily, as a **minimum**. They are **in addition to**, not **in place of** Federal Motor Carrier Safety Regulations. These may be purchased by writing to:*

Superintendent of Documents

U.S. Government Printing Office

Washington, DC 20402

PART 7: STARTING & OPERATING THE VEHICLE

Since each vehicle is custom-equipped, all engine operation instructions in this manual are general. You will want to consult the manual for your engine to find out details about your specific engine's needs. You may need to use a slightly different procedure from the one outlined here. Below are instructions for both normal-temperature starting and cold-weather starting.

Normal Temperature Starting Procedure

When the outside temperature is above 50° F (10° C), you can use the following procedure.

1. Set the parking brake.
2. Put your main transmission in Neutral.
3. Disengage (depress) the clutch (with manual transmission).

4. Turn the key switch to ON.

- The driver information display will proceed through the instrumentation self test (refer to [page 18](#) for a description of the instrumentation self test).



NOTE: Refer to [“Warning Light/Indicator Symbol Descriptions,” Page 23](#) if the Driver Information Display other messages or if other alarms activate after the key is turned ON.

5. Turn the key to start.



CAUTION: Never operate the starter motor while the engine is running. The starter and flywheel gears could clash or jam, severely damaging them.



NOTE: Some starters are equipped with overcrank protection. Check the “Engine Operation and Maintenance Manual” for details.

If the engine does not start within 30 seconds, release the starter button. To avoid overtaxing the starter motor or the batteries, don't use the starter for more than 30 seconds. Let the starter motor cool and the batteries recover for 2

minutes before trying again. If the engine still won't start after a couple of tries, check the manual override shut-down valve and fuel lines for possible fuel starvation or air leaks. Starting failure may mean fuel isn't reaching the injectors.

1. As soon as the engine starts, begin to watch the oil pressure gauge. Check your engine manufacturer's manual for the right pressure for your engine. If the oil pressure doesn't rise within a few seconds, stop the engine. Find out what is wrong before restarting the engine.
2. Slowly engage (release) the clutch after the engine has started.
3. Wait until normal engine oil pressure registers on the gauge before idling or accelerating the engine beyond 1000 RPM.

Cold Temperature Starting Procedure

In cold weather, fast engine starting helps relieve the loads on the electrical system and cranking motor. Using the special cold starting equipment will help starting. If you follow a few simple guidelines, you will extend the service life of your engine.

- Keep the electrical system in top condition.
- Use the best quality fuel of the recommended grade.
- Use recommended engine lubricating oil.



WARNING! Do not use ether or starting fluid in conjunction with flame-start air intake heating systems. Flame-start systems use an open flame inside the manifold to heat the air/fuel mixture for cold weather starting. If ether is also used with flame-start, the air/fuel will ignite inside the manifold, which could cause an explosion, death or severe injury.

Engine Warmup

The purpose of engine warmup is to allow oil film to be established between pistons and liners, shafts and bearings while your engine gradually reaches operating temperature.

Warmup Procedure

1. After you've started your engine, idle it at approximately 600 RPM while you check
 - oil pressure
 - air pressure
 - alternator output



WARNING! Do not start or let the engine run in an enclosed, unventilated area. Exhaust fumes from the engine contain carbon monoxide, a colorless and odorless gas. Carbon monoxide can be fatal or can cause serious respiratory illness if inhaled.

2. After a few minutes of idling at 600 RPM, increase your idle speed to 900 or 1000 RPM. Continue your warmup. This procedure allows oil to warm and flow

freely while pistons, liners, shafts, and bearings expand slowly and evenly. In extremely cold temperatures, you may have to increase idle speed.



NOTE: In colder climates where the temperature is often below freezing, the warmup for turbocharged engines is especially important. Chilled external oil lines leading to the turbocharger will slow the oil flow until the oil warms, reducing oil available for the bearings. Watch the engine oil temperature or pressure gauge for a warming trend before increasing engine idle speed (RPM).

3. Continue the engine warmup until the coolant temperature reaches at least 130° F (54° C). At this temperature, you can use partial throttle. Wait until the coolant temperature is at least 160° F (71° C) before operating at full throttle.



WARNING! Exhaust fumes from the engine contain carbon monoxide, a colorless and odorless gas. Do not breathe the engine exhaust gas. A poorly maintained, damaged or corroded exhaust system can allow carbon monoxide to enter the cab or sleeper. Entry of carbon monoxide into the cab is also possible from other vehicles nearby. Failure to properly maintain your vehicle could cause carbon monoxide to enter the cab/sleeper and causes death or serious illness.



WARNING! Never idle your vehicle for prolonged periods of time if you sense that exhaust fumes are entering the cab or sleeper. Investigate the cause of the fumes and correct it as soon as possible. If the vehicle must be driven under these conditions, drive only with the windows slightly open. Failure to repair the source of the exhaust fumes may lead to death or personal harm.



CAUTION: The use of a winterfront can result in excessive engine coolant, oil, and charge air (intake) temperatures, which can lead to overheating and possible engine damage. If you must use a winterfront:

- Refer to the “Engine Operation and Maintenance Manual” for operating restrictions and recommendations.
- Use only a winterfront available from your Peterbilt dealer that is compatible with a EPA-compliant engine cooling system. These winterfronts are specifically designed for use with new grill snap patterns.

**NOTES:**

- *Keep the engine exhaust system and the vehicle's cab/sleeper ventilation system properly maintained. It is recommended that the vehicle's exhaust system and cab/sleeper be inspected*
 - *By a competent technician every 15,000 miles*
 - *Whenever a change is noticed in the sound of the exhaust system*
 - *Whenever the exhaust system, underbody, cab or sleeper is damaged*
- *Do not stay in the vehicle with the engine running or idling for more than 10 minutes with the vehicle's Heater and A/C ventilation system in RECIRC or at LOW FAN SPEED. Even with the ventilation system On, running the engine while parked or stopped for prolonged periods of time is not recommended.*
- *If other vehicles are parked next to you idling, move your vehicle or do not stay in your vehicle for prolonged periods of time.*

Transmission Warmup

In cold weather you may find shifting sluggish when you first start the engine. Transmission warmup is especially important at this time, but it is always a good idea to warm up your transmission before starting out on the road. To warm up the transmission lubricating oil during engine warmup, with a single transmission:

- Check that the transmission is in Neutral.
- Release the clutch pedal.

If you have a two-transmission combination:

- Put the main transmission in gear.
- Put the auxiliary transmission in Neutral. This will allow the transmission countershaft to turn, agitating the oil and warming it.

Idling the Engine

Under most circumstances, idling your engine for long periods merely wastes fuel. In severe arctic weather conditions, however, you may need longer idling to be sure all parts of your engine are fully lubricated.



WARNING! To reduce the chance of personal injury and/or vehicle damage from overheated engines, which can result in a fire, never leave the engine idling without an alert driver present. If the engine should overheat, as indicated by the engine coolant temperature light, immediate action is required to correct the condition. Continued unattended operation of the engine, even for a short time, may result in serious engine damage or a fire.



CAUTION: Do not allow your engine to idle, at low rpm's (400–600 rpm), longer than five minutes. Long periods of idling after the engine has reached operating temperatures can decrease engine temperature and cause gummed piston rings, clogged injectors, and possible engine damage from lack of lubrication. The normal torsional vibrations generated can also cause transmission wear.

During the time it takes you to drink a cup of coffee, your engine can cool as much as 60° F (33° C) below normal operating temperature. To keep the engine warm during a short break, turn it off. And don't allow your engine to idle longer than five minutes.

Putting The Vehicle In Motion

This section discusses the clutch and transmission operation to get your Peterbilt underway.



WARNING! Do not carry loose objects in your cab, it can be dangerous. In a sudden stop, or even going over a bump in the road, they could fly through the air and strike you or a passenger. You could be injured or even killed. Secure all loose objects in the cab before moving the vehicle.



CAUTION: Do not try to put the vehicle in motion before pressure in the system reaches 100 psi (689 kPa) because the wheels are locked by the spring brake action. Unnecessary stress and possible brake malfunction could occur if the vehicle is forced to move before the air system reaches 100 psi (689 kPa).

Shifting The Transmission

You will find a shift pattern either on a decal in your cab or on a medallion in the shift knob. Check to be sure you know the correct sequence for your particular transmission. Refer to the transmission manual included with your vehicle for complete instructions in the operation of your transmission.

Shifting Gears in a New Vehicle

Shift carefully in a new vehicle. The transmission may be a little stiff at first. So be careful to avoid gear clashing.

When you are operating a new vehicle or one that has been exposed to cold weather, you want the transmission lubricant to circulate and coat the contacting surfaces of the gears. Metal contacting metal in moving parts may seriously damage your transmission. So don't drive in one gear for long until the transmission lubricant has had a chance to coat those contacting surfaces.

Operating the Clutch

“Riding” the Clutch

The clutch pedal is not a footrest. Driving with your foot on the clutch pedal will allow your clutch to slip, causing excessive heat and wear. You can damage your vehicle this way.

Clutch Travel



CAUTION: Always use first gear or a low speed range to start the vehicle in motion. The use of a higher gear or speed range forces undue strain on the engine, clutch, other transmission components, and may cause damage.

To put your vehicle into motion, push down on the clutch pedal until the clutch brake makes contact. This contact will occur at about 1/2 inch to 1 inch from the end of pedal stroke. Select a gear low enough to let your vehicle start forward with the throttle at idle until the clutch is fully engaged.

The total stroke of the clutch pedal is about 10 inches. The first 1 3/4 to 2 inches is free travel. After that is the release stroke, the part that fully releases the clutch. The last 1/2 to 1 inch engages the clutch brake. If your vehicle is new, watch the free travel in your clutch carefully for the first few hundred miles. As your clutch lining wears and high spots get worn smooth, you will get less free travel.

Always start out in a low gear with a ceramic-faced clutch. Starting in higher gears, even with a light load, will cause a very jumpy start and excessive wear.

And don't allow your vehicle to roll in the opposite direction at all during clutch engagement. If you need to start up on an incline, apply your service brakes before you release the parking brake. Then release your service brakes as you engage the clutch and apply throttle.

Release Bearing Wear

When you must idle your engine for any period of time, shift your transmission to neutral and engage the clutch (take your foot off the pedal). This helps prevent unnecessary wear of your clutch release bearing. And it is less tiring for you, too.

Clutch Adjustment

Inspect manual and self-adjusting clutches regularly to maintain correct clutch adjustment. Have your dealer's service department perform any adjustments necessary. Do not adjust your clutch by adjusting the external linkage without first checking (and correcting if necessary) the internal clutch adjustment. Using only the external linkage adjustment could damage the clutch.

Clutch Brake

Your clutch brake is used for stopping gear rotation to let you shift into 1st gear or reverse when your vehicle is at a standstill.

About the last 1/2 to 1 inch of clutch pedal travel activates your clutch brake. So if you are stopped and want to shift directly into 1st or reverse, depress the clutch pedal until contact with the clutch brake is made to stop transmission gear rotation.

If you have a butt-tooth condition and can't shift the transmission, gradually release the clutch. Then the drive gear can roll enough to allow the teeth to line up properly and complete the shift.



CAUTION: *Be careful not to apply the clutch brake while the vehicle is moving. The purpose of the clutch brake is to stop the transmission so that you can shift into a starting gear without grinding. Applying the clutch brake when the vehicle is moving causes a braking effect on the entire vehicle. This wear naturally shortens the service life of your clutch brake.*

Double Clutching

Whether you are upshifting or down shifting, it is best to double clutch. Double clutching is easier on your transmission and on your engine, helping your vehicle match engine speed with driveline speed and achieving clash-free shifts. To double clutch:

1. Push down the clutch pedal to disengage the clutch.
2. Move the gear shift lever to neutral.
3. Release the pedal to engage the clutch. This lets you control the RPM of the mainshaft gears. Thus you can match the RPM of the mainshaft gears to those of the output shaft.

- **Upshifts** - Let the engine and gears slowdown to the RPM required for the next gear. Use the tachometer to determine optimum RPM for gear engagement.
- **Downshifts** - Press accelerator to increase engine and gear speed to the RPM required in the lower gear. Use the tachometer to determine optimum RPM for gear engagement.

4. Now quickly press the pedal to disengage the clutch. Move the gear shift lever to the next gear speed position.
5. Release the pedal to engage the clutch.

Interaxle Differential

On vehicles with tandem rear axles, the interaxle differential allows each axle to turn independently. Differential action between the tandems relieves stress on the rear axles and tires and provides better performance. When operating normally on paved, dry surfaces, keep your truck's interaxle differential in the UNLOCK position.

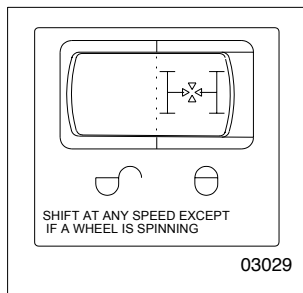

Switch In Unlock Position



WARNING! Do not engage the differential lock while operating on dry pavement; it could lead to an accident involving death or personal injury. You will not be able to safely steer the vehicle while using the differential lock and driving on dry pavement. Only engage the switch for short periods of time to move the vehicle in a straight motion.

To lock the differential, ease up on the throttle. Be sure to stop any spinning wheels. Then push the switch to the LOCK position. It may be necessary to use light throttle to help engage the differential lock.



WARNING! Do not engage the differential lock if the vehicle is moving or if the tires are slipping. Otherwise, the vehicle may move in an unexpected direction, and could cause an accident involving death or personal injury. This may also lead to equipment damage. Bring the vehicle to a complete stop and ensure that all wheels are not spinning before engaging the differential lock switch.

In the LOCK position, continuous operation on a paved, dry surface stresses the tandem axles, possibly causing internal damage to them.

- Shift into the LOCK position to operate on slippery surfaces like
 - Ice or snow - with or without tire chains
 - Dirt roads
 - Loose sand, mud, or other off-road conditions
- Switch into LOCK when checking performance on a chassis dynamometer.



WARNING! Do not use the differential lock at speeds greater than 25 mph (40 kph); it could lead to an accident involving death or personal injury. A vehicle with the differentials locked will be difficult to steer. At higher speeds, you may lose control of the vehicle. Only engage the differentials to maneuver through areas of poor traction. Do not keep driving with the switch in the LOCK position.

Dual Range (Two Speed) Axles

If you have this option, dual range axles provide two rear axle ratios for operating under heavy loads or off-highway as well as for over the road trucking. The Low range provides maximum torque for off-road work. The High range is a faster ratio for highway speeds and conditions. A switch on your instrument panel controls this function. You will notice that it has a guard to protect you from activating it accidentally.

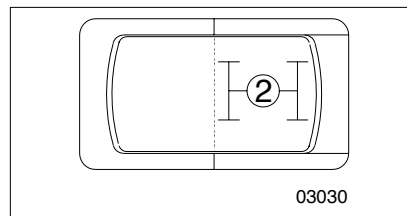

Range Selector

Using Your Dual Range Axle



WARNING! Never shift the axle when moving downhill. Engine driveline disengagement may occur, eliminating engine retardation and allowing the wheels to spin faster than the current speed of the engine. This may require severe braking to slow the vehicle down and can result in an accident involving death or personal injury.

1. Unlock the interaxle differential before starting.
2. Put the Range Selector in the LOW range. Shift the transmission to start the truck moving.

3. Off-Highway: When you are driving on rough terrain and secondary roads, or under a very heavy load, keep the axle in the LOW range. Shift your transmission to maintain the road speed you want.
4. When you go from off-highway to highway driving, shift the axle to the HIGH range this way:
 - a. Be sure the differential is UNLOCKED.
 - b. Keep the accelerator down and move the Range Selector lever to HIGH.
 - c. Keep driving with the accelerator down until you want the axle to shift.
 - d. Then release the accelerator until the axle has shifted.
 - e. You are now in the HIGH axle range on the highway. Shift the transmission normally to reach your desired cruising speed.
5. If you need to downshift the axle for more power
 - a. Keep the accelerator down & move the Range Selector lever to LOW.
 - b. Keep driving with the accelerator down until you want to downshift the axle.
 - c. Then release and depress the accelerator pedal quickly to increase the engine RPM.

- d. The axle will shift to the LOW range.

Important Tips on Operating Your Dual Range Axle



NOTE: If your vehicle has an automatic transmission, it may be necessary to shift it to the Neutral position momentarily to allow the main differential lock splines to fully engage or disengage.

To avoid damaging your vehicle, shift the axle at a slower speed until you are used to driving with the dual range axle.

When driving on a surface with good traction, keep the interaxle differential unlocked. You can drive with the axle in LOW or HIGH range.

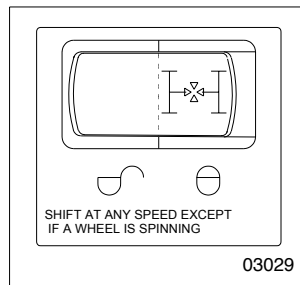

Interaxle In Unlock

When you are driving with poor traction, lock the differential. When you have the differential locked, drive with the axle in LOW range only.

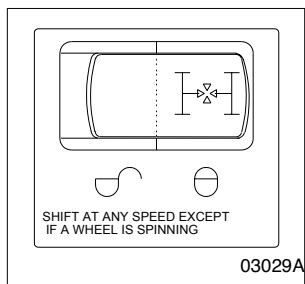

Interaxle In Lock

Always UNLOCK the interaxle differential before shifting the axle speed range.



CAUTION: If you shift the axle range with the interaxle differential in LOCK, you could do serious damage to your axles. Never shift the axle range with the differential locked.

- Park the truck with the Range Selector in LOW.

Automatic and Automated Transmission

An automatic or automated transmission makes shifting much easier. It remains important to completely understand how to operate the transmission to optimize its efficiency. Please read the manual for your automatic or automated transmission included with your vehicle.



WARNING! If your vehicle has a Freedom-line™ transmission, be aware that it can roll backwards when stopped on a hill or grade, or when starting from a stop on a hill or grade. This could cause serious damage, death or personal injury. Observe the following guidelines:

- When stopped on a hill or grade, press the brake pedal.
- When starting from a stop on a hill or grade, quickly remove your foot from the brake pedal and firmly press on the accelerator pedal.

Auxiliary Transmission

If you have an auxiliary transmission, see your transmission manufacturer's manual for its proper operation.

If Your Vehicle Must Be Towed

Follow these directions to ensure your vehicle is not damaged when towing is required.

1. Lift driving wheels off the ground or remove the driveline and axle shafts before towing the vehicle.



CAUTION: *Failure to lift the driving wheels off the ground or remove the driveline and axle shafts before towing the vehicle could seriously damage your vehicle. All lubricating and clutch application oil pressure is provided by an engine-driven pump, which does not work when the engine is stopped. When vehicles are towed either by wrecker or piggy-back, lubricant in the top front of the drive axle will drain to the rear. This will leave the top components dry, resulting in friction that will seriously damage these components.*

2. Cover open hubs when removing drive axle shafts.



CAUTION: *Water, dirt and other material can enter an open hub or axle. This can contaminate the axle fluid and cause possible damage to components. Ensure that the hubs are covered with plastic whenever a drive axle shaft is removed.*

3. For vehicles with driver-controlled main differential lock, install the caging bolt before removing the axle shafts for towing.



CAUTION: *To avoid damaging your vehicle shift the axle at slower travel speeds until you are used to driving with a dual range axle.*

- a. Remove the air line and firmly cap

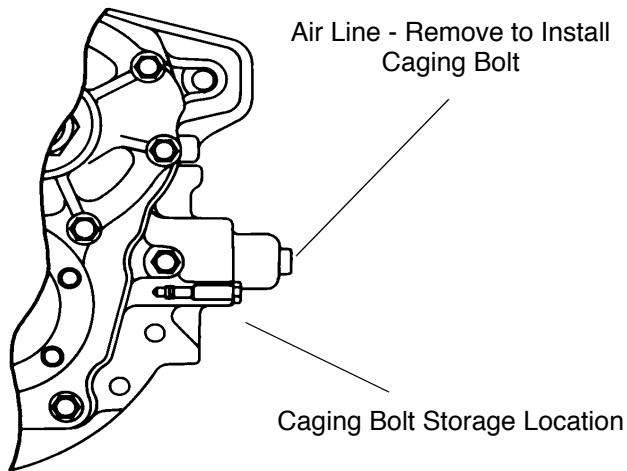

Illustration of Driver-Controlled Main Differential Lock

- b. Remove the caging bolt from its storage hole.
 c. Screw the caging bolt into the air line hole. When fully engaged, a 0.25 - 0.5 in. (6-1/2 mm) space will remain between the air cylinder and the bolt head. This action will lock the differential by pushing a piston into a "lock" position.



CAUTION: Failure to install the caging bolt when towing vehicles with driver-control main differential lock can result in damage by failing to lock internal components in position.



WARNING! Ensure there are no open air lines on the recovered vehicle if the recovery vehicle and recovered vehicle brake systems are connected. An open air line on the recovered vehicle will cause a leak in the air brake system of the recovery vehicle possibly causing an accident and death or personal injury.



CAUTION: A recovered vehicle will have no operational brake system. Additionally, the rear axle spring brakes will probably be applied.

- If you desire to use the recovered vehicle's brakes, ensure that the vehicles air system is connected to that of the recovery vehicle. Also ensure that any air line that has been removed from a driver-controlled main differential lock is firmly capped to prevent loss of air pressure from the recovery vehicle.

- ***If you don't desire to use the recovered vehicle's brakes, ensure that you cage the spring brakes before attempting to move the vehicle.***

4. Install recovery hitches and rigging.



CAUTION: Connect recovery rigging only to hitches intended for that purpose. Do not attach to bumpers or brackets. Connections to other structural parts could damage the vehicle.

5. Follow all state/provincial and local laws that apply to vehicles in tow.
6. Do not tow vehicles at speeds in excess of 55 mph (90 kph).

Returning a Towed Vehicle to Service

You will have to add lubricant to prevent damage after your vehicle has been towed.

1. Into the pinion cage, add 1 pint (.47 liter) of lubricant, OR
Into the inter-axle differential, add 2 pints (.94 liter) of lubricant. See the Index, under Lubricant Specifications, for the lubricant required by each axle.
2. After adding the specified type and amount of lubricant, drive the vehicle. It should be unloaded. Drive 1 to 2 miles (1.5 to 3 km) at a speed lower than 25 mph (40 km/h).

This will thoroughly circulate the lubricant through the assembly.

Anti-Lock Braking System Operating Information

A Model 587 is equipped with an anti-lock braking system (ABS). This ABS reduces the possibility of wheel lock-up. If a wheel is about to lock during braking, the ABS will automatically adjust air pressure to the brake chambers on the appropriate wheel(s) to prevent wheel lock-up. The ABS is automatically turned on when the ignition switch is turned on.

**WARNING!**

- **The brake system is a critical vehicle safety system. For the safety of you and others around you, have the vehicle submitted for periodic preventive maintenance checks as well as having any suspected problems immediately checked by an Authorized Service Center. Failure to properly maintain your brake system can lead to death or personal injury accidents.**
- **Do not drive through water deep enough to wet brake components, as it may cause the brakes to work less efficiently than normal. The vehicle's stopping distance may be longer than expected, and the vehicle may pull to the left or right when brakes are applied, which could contribute to an accident involving death or personal injury.**
- **Do not rely on an anti-lock brake system that is functioning improperly. You could lose control of the vehicle resulting in an accident involving death or personal injury. If any ABS lamp goes on while you are driving or stays on after the self-check, that anti-lock system might not be working. That**

ABS may not function in an emergency. You will still have conventional brakes, but not anti-lock brakes. If any warning lamp indicates a problem, have that ABS checked.

ABS Warning Lamps

Truck/Tractor ABS Warning Lamp

A truck/tractor ABS warning lamp illuminates when the ignition switch is first turned on and will remain on until the system self-test has been completed successfully. Normally, this ABS lamp will remain on until a speed of no more than 9 mph has been reached and the speed sensors have been checked for correct output. The lamp should remain off after this point unless a failure in the system is detected.



CAUTION: If the truck/tractor ABS warning lamp does not illuminate when the ignition is first turned on, there is a problem with the bulb or wiring. The driver should have this checked as soon as possible.

The truck/tractor ABS lamp is located in the warning lamp cluster. (See illustration on [page 17](#).)

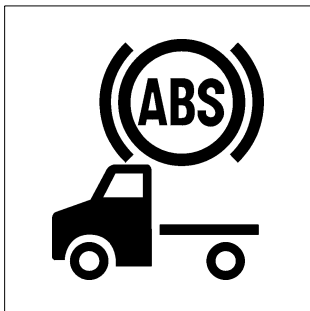

Trailer ABS Warning Lamp

Trucks, tractors, and trailers built on and after March 1, 2001 are equipped with power line communication (PLC) per U.S. FMVSS 121, including a PLC Trailer ABS warning lamp in the cab (see [page 17](#)):

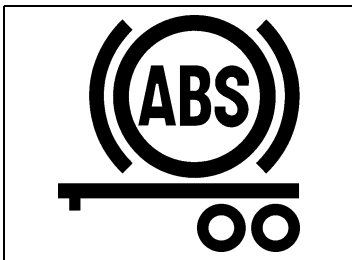

CAUTION: If the trailer ABS warning lamp does not illuminate when the ignition is first turned on, there is a problem with the bulb or wiring. The driver should have this checked as soon as possible.



NOTE: A successful warning lamp illumination and bulb check at ignition on does not indicate that the trailer you may be connected to has trailer ABS. You should personally inspect every trailer to determine its braking system.

A trailer ABS warning lamp will illuminate for a bulb check when the ignition switch is first turned on - whether or not a trailer is connected to the vehicle. If the bulb check is satisfactory, the lamp will next do either of the following:

1. If no trailer is connected, or if a non-ABS-equipped trailer is connected, the trailer ABS lamp will go off after a few seconds.

**CAUTION:**

- **The center pin of the 7-way trailer light line may be constantly powered for ABS. Make sure it will not accidentally turn on trailer equipment.**
- **Do not splice into the non-switchable “Auxiliary” circuit on the primary 7-way trailer light line. Doing so may cause the trailer ABS to malfunction. This circuit is dedicated for trailer ABS power. To add a switchable “auxiliary” circuit, contact a Peterbilt Authorized Dealership.**

**NOTES:**

- A “properly connected” ABS-equipped trailer is
 - a trailer with PLC hooked up to the J560 connector
 - a trailer without PLC that is hooked up to an optional ISO 3731 connector
- For doubles or triples: PLC does not distinguish between trailers. An ABS problem in any trailer will activate the trailer ABS warning lamp.

2. If an ABS-equipped trailer is properly connected, the trailer ABS warning lamp will remain illuminated for a few more seconds while the trailer ABS is tested.
 - If no trailer ABS problems are detected, the lamp will go off.
 - If a trailer ABS problem is detected, the lamp will remain on. The driver should have the trailer’s ABS problem corrected before the vehicle is driven with that trailer attached.

Advanced ABS with Stability Control

This vehicle may be equipped with an optional Electronic Stability Program (ESP). ESP is a feature for ABS-equipped vehicles that reduces the risk of rollovers, jackknifing and other loss of control. ESP features include Roll Stability Program (RSP) and Yaw Control.



WARNING! While ESP may reduce the risk of losing control of the vehicle, it does not prevent an event where the vehicle is not under control. The driver must exercise extreme caution to prevent a rollover or other loss of control events. Failure to do so may result in an accident involving death or personal injury.

During operation, the ECU of the Bendix Advanced ABS system constantly compares performance models to the vehicle's actual movement, using the wheel speed sensors of the ABS system, as well as lateral, yaw, and steering angle sensors. If the vehicle shows a tendency to leave an appropriate travel path, or if critical threshold values are approached, the system will intervene to assist the driver.

Roll Stability Program

Bendix RSP, an element of the overall ESP system, addresses rollover conditions. In the case of a potential roll event, the ECU will override the throttle and quickly apply brake pressure various wheel ends to slow the vehicle combination. The level of braking application during an RSP event will be proportional to roll risk.

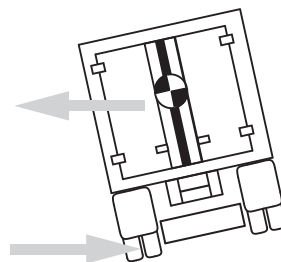

A Real World Example Of How The RSP System Operates:

Excessive speed for road conditions creates forces that exceed the threshold at which a vehicle is likely to rollover on a higher-friction surface.

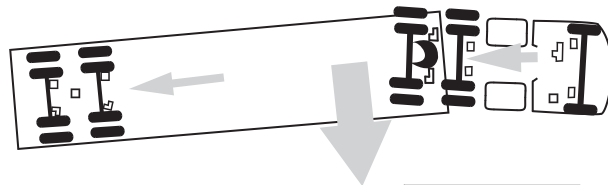

The system automatically reduces engine torque and applies the service brakes (based on the projected rollover risk) to reduce the vehicle speed, thereby reducing the tendency to roll over.

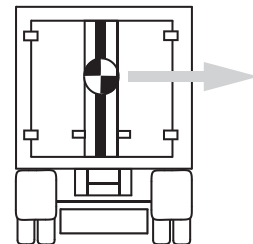

RSP Example

Yaw Stability

Yaw stability counteracts the tendency of a vehicle to spin about its vertical axis. During operation, if the friction between the road surface and the tires is not sufficient to oppose lateral (side) forces, one or more of the tires can slide, causing the truck/tractor to spin.

These yaw events are referred to as either “under-steer” (where there is a lack of vehicle response to steering input due to tire slide on the steer axle) or “over-steer” (where the tractor’s rear end slides out due to tire slide on the rear axle) situation. Generally, shorter wheelbase vehicles (tractors, for instance) have less natural yaw stability, while longer wheelbase vehicles (straight trucks, for instance) have greater natural yaw stability. Factors that influence yaw stability are: wheelbase, suspension, steering geometry, weight distribution front to rear, and vehicle track width.

Yaw Control

Yaw Control responds to a wide range of low- to high-friction surface scenarios including rollover, jackknife and loss of control. In the case of vehicle slide (over-steer or understeer situations), the system will reduce the throttle and then brake one or more of the “four corners” of the

vehicle (in addition to potentially applying the trailer brakes), thus applying a counter-force to better align the vehicle with an appropriate path of travel. For example, in an over-steer situation, the system applies the “outside” front brake; while in an under-steer condition, the “inside” rear brake is applied.

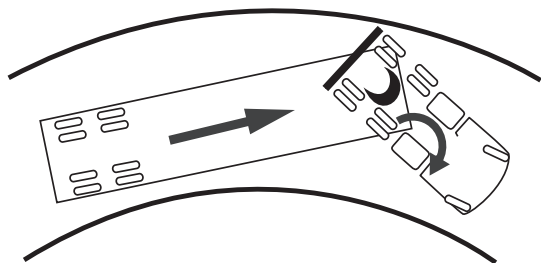

A Real World Example Of How Yaw Control Operates:

Excessive speed exceeds the threshold, creating a situation where a vehicle is likely to spin and jackknife.

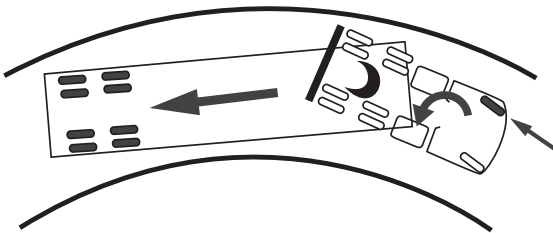

The Bendix® Yaw Control system reduces engine throttle and selectively applies brakes to reduce the vehicle speed, thereby reducing the tendency to jackknife.

Yaw Control Example

IMPORTANT SAFETY INFORMATION ABOUT THE STABILITY SYSTEM

ESP May Reduce The Vehicle Speed Automati- cally

To minimize unexpected deceleration and reduce the risk of a collision the operator must:

- Avoid aggressive driving maneuvers, such as sharp turns or abrupt lane changes at high speeds, which might trigger the stability system.
- Always operate the vehicle safely, drive defensively, anticipate obstacles and pay attention to road, weather and traffic conditions. ABS, ATC and ESP stability systems are no substitute for prudent, careful driving.

Towing Doubles Or Triples May Reduce The Effective- ness Of Stability Systems

ESP is designed and optimized for trucks and for tractors that tow single trailers. If a tractor equipped with ESP is used to power multiple trailer combinations (known as “doubles” or “triples”) the effectiveness of the ESP system may be greatly reduced.



WARNING! Exercise extreme care when towing doubles or triples with a vehicle equipped with Electronic Stability Program. Excessive speed and aggressive maneuvers, such as sharp turns, sudden steering inputs or abrupt lane changes should be avoided because these maneuvers could cause loss of vehicle control possibly resulting death or severe personal injury.

Limitations Of Stability Systems

The ESP stability system's effectiveness may be greatly reduced if:

- The load shifts due to improper retention, accident damage or the inherently mobile nature of some loads (for example, hanging meat, live animals or partially laden tankers),
- The vehicle has an unusually high or off-set center of gravity (CG),
- One side of the vehicle drops off the pavement at an angle that is too large to be counteracted by a reduction in speed,
- The vehicle is used to haul double or triple trailer combinations,

- If very rapidly winding steering inputs are inputted at high speeds,
- There are mechanical problems with suspension leveling of the tractor or trailer resulting in uneven loads,
- The vehicle is maneuvering on a high banked road creating either additional side forces due to the weight (mass) of the vehicle or a deviation between expected & actual yaw rates,
- Gusty winds are strong enough to cause significant side forces on the vehicle and any towed vehicles.

To Maximize The Effectiveness Of ESP:

- Loads must be properly secured and evenly distributed at all times.
- Drivers need to exercise extreme caution at all times, and avoid sharp turns, sudden steering inputs or abrupt lane changes at high speeds, particularly if:
 - the vehicle hauls loads that could shift,
 - the vehicle or load has a high or off-set center of gravity (CG) when loaded, or
 - the vehicle tows doubles or triples.

Truck Chassis Modifications

The ESP system was specifically calibrated and validated only for your vehicle's original factory-built configuration. If your vehicle's chassis components are altered (for example; a wheelbase extension or reduction, tag axle addition or removal, tractor to truck conversion or steering system component change) the ESP system must be disabled immediately by a qualified mechanic.



WARNING! Failure to disable ESP “Electronic Stability Program” when modifying a vehicle could result in a loss of vehicle control possibly resulting in death or severe personal injury.



WARNING! For vehicles equipped with ESP “Electronic Stability Program” do not replace the vehicle's steering wheel. Using a different steering wheel could cause ESP to malfunction causing a loss of vehicle control possibly resulting in death or severe personal injury.

Steering Angle Sensor Re-Calibration

Whenever maintenance or repair work is performed to the steering mechanism, linkage, gear, adjustment of the

wheel track, or if the steering angle sensor is replaced or the steering wheel is changed or re-centered, the Steering Angle Sensor must be re-calibrated.



WARNING! If the Steering Angle Sensor is not re-calibrated, the Yaw Control system will not function properly, which could result in a loss of control of your vehicle, death or personal injury.

Wheel Spin Control Warning Lamp

Your truck/tractor ABS may have an acceleration slip regulation (ASR) or automatic traction control (ATC) feature. This feature is controlled by a switch as shown in the next illustration. Either of these features is monitored by a warning lamp located on the main dash.

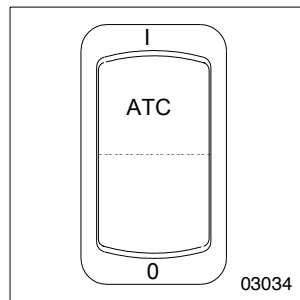

The Wheel Spin Control warning lamp will briefly illuminate and then go out when the ignition switch is first turned on. The Wheel Spin Control warning lamp will illuminate whenever the ASR or ATC system detects drive wheel spin. The lamp will remain illuminated as long as wheel spin is detected and the ASR or ATC system is applying the drive wheel brakes or reducing engine torque. Do not allow the Wheel Spin Control lamp to remain on continuously for an extended length of time. Extended continuous use of the ASR / ATC can cause overheating of the drive wheel brakes. Engine torque or vehicle speed should be reduced to eliminate wheel spin and prevent excessive application of the ASR/ATC system.

Except for checking for proper illumination of the ABS and Wheel Spin Control warning lamps when first starting the vehicle, and for monitoring these lamps while driving, no special operating procedures are required. For detailed system description, see service literature for your specific ABS that was provided with your vehicle.

Brake Safety and Emergency

To stop your vehicle in an emergency, vary the service brake application pressure to provide maximum braking force without locking the wheels. Use engine compression to assist the service brakes; i.e., don't depress the clutch pedal until the engine reaches idle speed.



WARNING!

- ***Do not operate the vehicle in the event of a malfunction in any air circuit. The vehicle should not be operated until the system is repaired and both braking circuits, including all pneumatic and mechanical components, are working properly. Loss of system air can cause the service brakes not to function resulting in the sudden application of the spring brakes causing wheel lock-up, loss of control, or overtake by following vehicles. You could be in an accident, be killed or severely injured.***



WARNING! Unless you have an anti-lock braking system, always avoid completely depressing the service brake pedal, if possible, even during emergency braking. Depressing the brake pedal too aggressively can cause the wheels to lock, which can lead to an uncontrolled skid and could cause an accident involving death or personal injury.

Overheated Brakes

Under normal braking conditions, the energy generated will bring the internal brake drum temperature to about 500° F (260° C). This is well within the safe zone: The maximum safe temperature of linings for drum type brakes is usually about 800° F (427° C).

But if service brakes are used improperly or for prolonged periods, internal brake drum temperatures may commonly exceed 800° F (427° C). Such brake overheating may be detected by a burning smell or smoke coming from a drum. If this occurs, you should immediately stop and check for cracked brake drums or lining fires. If neither exists, get back behind the wheel and resume a slow speed as soon as possible to cool the brakes.

Parking Brakes and Their Use

The yellow diamond-shaped knob on your instrument panel controls your parking brakes. These are spring brakes which you activate by releasing air pressure from their chambers. When they are not in use, air pressure compresses the springs and releases the brakes. But putting the valve in the Park position exhausts air from the chambers and allows the springs to extend and apply the brakes. Also, if your system air drops below the safe operating level, the spring brakes will apply automatically, bringing your vehicle to a stop.



WARNING! On trailers built before March 1975 you may not have parking brakes if the trailer reservoir pressure leaks down. If you depend on them to hold your vehicle, they could release, causing a serious accident involving death or personal injury. These older trailers have emergency brakes not designed for parking. They will apply only if there is enough trailer reservoir pressure. Don't use your trailer emergency brakes for parking. Apply your tractor parking valve too.

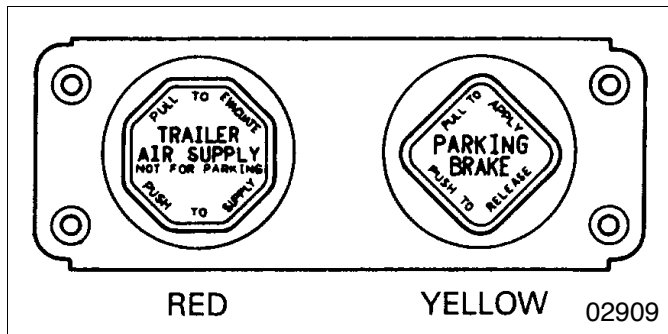

Red / Yellow Controls

**WARNING!**

- **Do not leave the cab without applying the parking brake. The truck could roll and cause an accident involving death or personal injury. Always apply the parking brake before you leave the cab.**
- **Stopping with the parking brake controls can cause a sudden wheel lock-up, loss of control, or can cause you to be overtaken by following vehicles. You could be killed or severely injured. Never pull out the parking brake valve while the vehicle is moving.**
- **Do not use the trailer hand brake or service brakes to park and hold an unattended vehicle—use the parking brakes. Because service brakes work with air pressure, these brakes could slowly release. Your vehicle could roll, causing an accident involving death or personal injury. Someone could be hurt or killed. Never rely on the service brakes to hold a parked vehicle.**
- **Never drive your vehicle with the parking brake applied. Always release the parking brakes prior to moving the vehicle. Failure to disengage the parking brakes prior to moving**

your vehicle could result in excessive heat build-up in the brake system, resulting in a fire.



NOTE: Today's diesel electronic engines have significant torque and startability power at low RPM. Combinations of engine speed and available torque may over-power the vehicle's parking brakes.

To apply all your parking brakes, pull the yellow knob Out. The parking brakes will set. And the trailer air supply valve (red octagon knob) will automatically pop out, releasing air pressure and setting the trailer brakes.



CAUTION: Do not try to put the vehicle in motion before pressure in the system reaches 100 psi (689 kPa) because the wheels are locked by the spring brake action. Unnecessary stress and possible brake malfunction could occur if the vehicle is forced to move before the air system reaches 100 psi (689 kPa).

To release your truck or tractor brakes ONLY, push in the yellow knob. Your trailer will remain parked.

- To release the trailer brakes ONLY, push in the red knob. The truck or tractor will remain parked.

- To release the full combination of brakes, push in BOTH yellow and red knobs.

Trailer Air Supply Valve

The red octagon knob controls the air supply to the trailer. To supply air to the trailer system and release the trailer parking brakes:

- Allow the tractor air system pressure to build up to operating level.
- Push the red knob in.
- Hold the red knob in by hand until the trailer air pressure builds to a pre-set level, about 45 psi. At this point it will remain in.

The yellow knob will remain out; the tractor will remain parked. If you ever have a failure or disconnect of the air supply hose to the trailer, the trailer parking brakes will set. The red knob will automatically pop out and seal off the tractor air reservoirs to protect the tractor air system pressure. When operating the tractor "bobtail": The red knob must remain out to protect the tractor air system pressure.

Manually Releasing Spring Brakes

There may be an occasion when you need to tow the vehicle but the air system does not produce enough operating pressure to release the parking brakes. For these situations, the spring brakes may be manually released to allow the vehicle to be towed. This section details how to release a drum or an air disc brake.



WARNING!

- ***Do not operate a vehicle when the spring brakes have been released manually. Driving a vehicle that has had its spring brakes manually released is extremely dangerous. You would probably have no brakes at all, which could cause death or serious injury.***
- ***Releasing the spring brakes on an unsecured vehicle could lead to an accident. The truck could roll, causing death or severe injury. Always secure the truck with wheel chocks, chains, or other safe means to prevent rolling before manually releasing the spring brakes.***



- ***Disassembling the spring brake chamber is dangerous and could cause death or serious injury. These chambers contain a powerful spring that is compressed. Sudden release of this spring could cause you to be badly injured. Do not disassemble a spring brake chamber.***

NOTE: The primary purpose of the manual release feature is to permit the vehicle to be towed to a repair facility.

To release spring brakes manually

1. Remove the cap from the spring chamber.

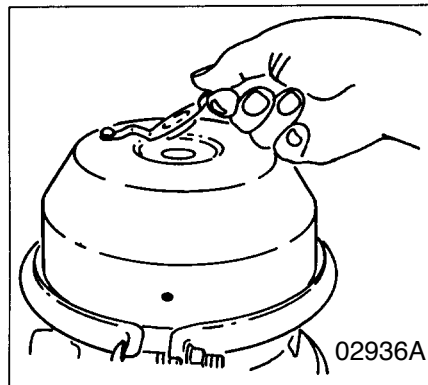

2. Remove the release stud assembly from the side pocket; remove the release nut and washer from the release stud.

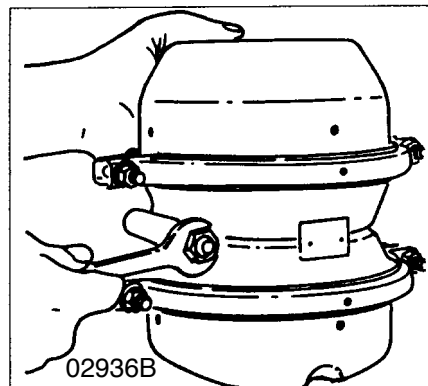

3. Slide out the release stud

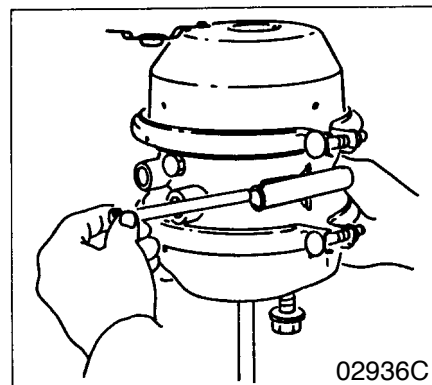

4. Insert the release stud through the opening in the spring chamber where the cap was removed. Insert it into the pressure plate. Turn the release stud 1/4-turn clockwise in the pressure plate. This secures the cross pin into the cross pin area of the pressure plate and locks it into the manual release position.

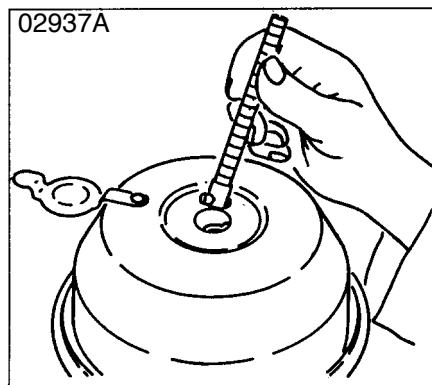

5. Assemble the release stud washer and nut on the release stud.

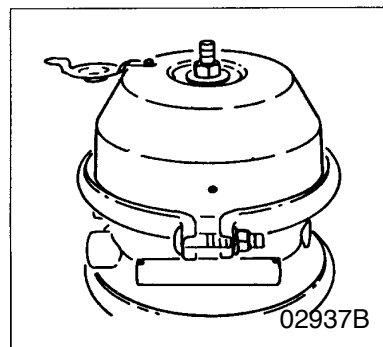

6. With a wrench, turn the release stud assembly nut until the compression spring is 90% - 95% caged. While doing this, check to make sure the push rod (adapter push rod or service push rod) is retracting. Do not overtorque the release stud assembly. (S-Cam type maximum 50 ft.-lb., Wedge type maximum 30 ft.-lb.) The spring brake is now mechanically released.

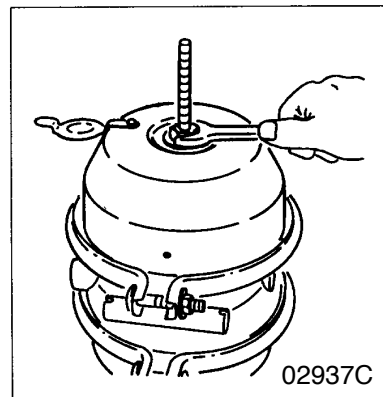

Retarders

Various retarders are available which function against the engine, driveline, or transmission. These are devices that use your engine's power to slow down your vehicle. They save wear and tear on your service brakes and can be a safety feature, too, because they can keep your brakes from overheating.

Ideally, you should always slow your vehicle with your retarder (where permitted by law) and use your service brakes only for stopping completely. Operating this way will greatly prolong the life of your brakes.



WARNING!

- ***In an emergency, the retarder might not stop you fast enough to prevent an accident. You could be killed or severely injured if you relied only on your retarder. Use the service brakes for quick stops. The retarder is not an emergency brake.***

- ***The retarder is NOT intended as the primary brake for the vehicle, nor is it an emergency brake. The retarder only helps the service brakes by using pressure to slow the drivetrain. Use the service brakes for quick stops.***
- ***Do not use the retarder when operating on road surfaces with poor traction (such as wet, icy, or snow covered roads or gravel). Retarders can cause the wheels to skid on a slippery surface. You could lose control of the vehicle if the wheels begin to skid, resulting in an accident involving death or personal injury.***

Driving Bobtail or with an Unloaded Trailer

We recommend that you do not use your engine retarder to slow down when you are bobtailing or pulling an empty trailer.



WARNING! Using an engine retarder can cause a wheel lockup. The trailer is not loading the tires enough to give the traction you may need. When you are bobtail or unloaded, you can have a serious accident if your wheels lock suddenly during braking. You could be killed or injured. Don't use your retarder when you are driving bobtail or with an unloaded trailer.

Exhaust After-Treatment System



NOTE: The emission warning lamps and emission switch functions described below supersede those listed in the Engine manufacturer's Operator and Maintenance manual. For additional Emissions Aftertreatment information specific to your engine, see the Engine manufacturer's Operation and Maintenance Manual supplied in your vehicle. All other lamp and switch functionality described in the manual are still valid.

In order to meet EPA engine emission requirements, vehicles will have an exhaust After-Treatment System (ATS) which includes a Diesel Particulate Filter (DPF), Regeneration Switch and warning lights. The DPF will trap soot from the engine exhaust gases. The ATS will periodically regenerate the DPF.

The Regeneration Switch is mounted on the dash and can override the ATS. Various situations may require the operator to use the functions of this switch. Refer to "Regeneration Switch" on page 51 to view the regeneration switch and its use. In addition, refer to "Parked Regeneration" on page 131 and "Stop an Automatic or Parked Regeneration" on page 133 for more operating information.

ATS specific warning lights and indicator symbols will reside in the driver information display unit.

Functionality / Notification Information



The ATS will regenerate the DPF by using hot exhaust gases normally generated by the engine. This typically occurs during highway operation. This is referred to as a

"Passive" Regeneration and is transparent to the operation of the vehicle.







Occasionally, the exhaust gases are too cool for passive regeneration. When this occurs, the ATS will regenerate the DPF by increasing the exhaust temperature. This is referred to as an "Automatic" Regeneration and is also transparent to the operation of vehicle. An Automatic Regeneration event typically lasts 30 minutes. During and shortly after the event, the exhaust gases from the DPF may reach temperatures in excess of 650 C (1200 F). See the information in the table below on probable causes and recommended actions related to the warning lights and indicator symbols of the ATS.









The ATS may not be able to regenerate the DPF when the vehicle is driven at extended low speeds or with frequent start and stops. In such cases, warning lights and indicator symbols will alert the operator to take action. The operator should be aware of whether the lights are on alone or in combination with others. The following table will describe each warning light(s) and what actions are needed from the operator.

Notification of High Exhaust System Temperature:

Indicator	Information	What to do
 On-Steady	<p>The High Exhaust Temperature (HEST) warning lamp will illuminate, regardless of ATS status, as the vehicle's exhaust outlet temperature becomes extremely hot (at least 450 deg C / 842 deg F) and subsequently the vehicle speed slows to below 5 mph / 8 kph.</p> <p>This will typically occur when:</p> <p>An Automatic or Parked Regeneration is in process</p> <p style="text-align: center;">or</p> <p>During normal vehicle operation when engine is under high or heavy loading</p>	<p>Follow all warnings listed below. Use the STOP function of the Regeneration Switch if the situation requires. Follow the instructions described "Stop an Automatic or Parked Regeneration" on page 133</p> <p> <i>WARNING! Temperatures of the exhaust pipes and at the outlets of the exhaust system during and shortly after a regeneration event will be extremely hot. If the High Exhaust System Temperature (HEST) warning lamp is on:</i></p> <ul style="list-style-type: none"> • <i>Do not park in an area of combustible vapors or materials. You must keep combustibles at least five (5) feet away from the side and top of the vehicle while the HEST light is illuminated. Always park your vehicle outside. Failure to do so could ignite an explosion which could result in serious injury or death.</i> • <i>Do not park in an area where people are close by. You must keep bystanders at least five (5) feet away from the exhaust outlet while the HEST light is illuminated. Failure to do so could result in serious injury or death.</i> • <i>The exhaust piping, diesel particulate filter (DPF) or tail pipe become extremely hot during engine operation or any regeneration event and can cause serious burns to the skin. Allow adequate cooling time before working on or near any part of the exhaust system.</i>

Notification That Regeneration Is Required:

Indicator	Information	What to do
 <p>On Steady</p>	<p>The DPF status indicator symbol will illuminate when the soot level in the DPF is above the desired level and it needs regenerating.</p>	<p>The DPF needs regenerating soon. Follow the instructions described “DPF Regeneration” on page 131</p> <p> NOTE: If you ignore the warning lamp and do not initiate regeneration at the soonest, safest possible time, the DPF will become increasingly clogged with soot and can lead to engine shutdown.</p>
 <p>Blink once every second</p>	<p>The DPF status indicator symbol will blink when the soot level in the DPF continues to stay above the desired level and it needs regenerating.</p>	<p>Regenerate the DPF as soon as safely possible. Follow the instructions described “DPF Regeneration” on page 131</p> <p> CAUTION: If you do not initiate regeneration after the DPF Indicator lamp is blinking, you only have a short time before the check engine light will illuminate and the engine will go into protection mode and de-rate power.</p>
 <p>Blinking</p>  <p>On Steady</p>	<p>The DPF status indicator symbol will blink when the soot level in the DPF continues to stay above the desired level and it MUST be regenerated.</p> <p>The engine will de-rate power.</p>	<p>Regenerate the DPF immediately. Follow the instructions described “DPF Regeneration” on page 131.</p> <p> CAUTION: If you do not initiate regeneration after the DPF Indicator lamp is blinking and the check engine light is illuminated, you only have a short time before the stop engine light will illuminate and the engine will automatically begin to shutdown.</p>

Indicator	Information	What to do
 Blinking  On Steady  On Steady	<p>(Caterpillar Engine)</p> <p>The DPF status indicator symbol will blink when the soot level in the DPF continues to stay above the desired level</p> <p>The soot level in the DPF is now at full capacity.</p>	<p>At this point, you CANNOT regenerate the DPF and the engine will begin a shutdown sequence.</p> <p> WARNING! <i>If the Stop Engine warning lamp illuminates, it means you have a serious engine system problem. This should be considered an emergency. You should stop the vehicle as safely as possible and turn OFF the ignition. The vehicle must be serviced and the problem corrected before driving again. Failure to do so may cause severe engine, DPF damage, death or personal injury.</i></p> <p> NOTE: <i>The engine shutdown sequence is engine specific; therefore to learn how this works on your vehicle, refer to the Engine Manufacturer's Operation and Maintenance Manual supplied with your vehicle.</i></p>
 On Steady	<p>(Cummins and PACCAR Engines)</p> <p>The Stop Engine light is illuminated when the soot level in the DPF continues to stay above the desired level</p> <p>The soot level in the DPF is now at full capacity.</p>	<p>At this point, you CANNOT regenerate the DPF and the engine will begin a shutdown sequence.</p> <p> WARNING! <i>If the Stop Engine warning lamp illuminates, it means you have a serious engine system problem. This should be considered an emergency. You should stop the vehicle as safely as possible and turn OFF the ignition. The vehicle must be serviced and the problem corrected before driving again. Failure to do so may cause severe engine, DPF damage, death or personal injury.</i></p> <p> NOTE: <i>The engine shutdown sequence is engine specific; therefore to learn how this works on your vehicle, refer to the Engine Manufacturer's Operation and Maintenance Manual supplied with your vehicle.</i></p>

DPF Regeneration

Carefully read the following instructions to regenerate the DPF. If you have any problems or difficulties contact your nearest Peterbilt authorized dealer for assistance.

The After-Treatment System (ATS) needs conditions typically found in highway driving to regenerate the DPF. If your DPF Indicator lamp is illuminated, the easiest option is to help the ATS by proceeding to the nearest highway.

- For the three position switch only, make sure the Regeneration Switch is in the CENTER position.
- Select a highway that has a posted legal speed of more than 40 mph.
- Drive your vehicle until the DPF light goes off. This may take 30 - 45 minutes of speeds greater than 20 mph (32 kph) for a Caterpillar engine or 40 mph (64 kph) for a PACCAR or Cummins engine.

If your operation or planned route in the immediate future limits your ability to reach highway speeds, proceed to the next section titled Parked Regeneration.

Parked Regeneration

In very limited applications or operations the DPF must be regenerated by initiating a Parked Regeneration. Follow these six steps to initiate a Parked Regeneration:

1. Pull the vehicle over to a safe location
2. Ensure no one is in the immediate vicinity to the tail pipe
3. Maintain a minimum of 5 feet of clearance to any combustible materials from the edge and top of the vehicle



WARNING! Parking the vehicle too close to any combustible materials or vapors may start a fire, ignite an explosion or burn someone standing close by. Before pushing the Regeneration switch on the dash, walk around your vehicle and ensure you have at least five (5) feet clearance from the sides and top of your vehicle to any combustibles. Ensure no one is in the immediate vicinity to the tailpipe. Failure to do so could cause a fire or lead to death or serious injury to you and/or bystanders.



WARNING! *Never initiate an regeneration in a closed building or enclosure. Always park your vehicle outside and ensure no one is in the immediate vicinity. Failure to do so could ignite an explosion or harm bystanders which could result in death or serious injury.*



NOTES: *Typical operation areas or materials that can contain explosive vapors, flammable materials or people in close proximity of the vehicle are*

- Fuel depots
- Grain elevators
- Dry grass, leaves or trees
- Transfer refuse stations/dumps
- Parking lots
- Load/unload terminals



NOTE: *While the list above may appear comprehensive, it is your responsibility to take the necessary precautions and be aware of your surroundings and ensure that no combustibles (materials or vapors) or bystanders are close by before initiating a regeneration.*

4. Verify that the following conditions are met before proceeding. A Parked Regeneration will not initiate if any of these conditions are not met.
 - Parking brake is applied / set
 - Engine is at low idle
 - No throttle, brake or clutch applied
 - PTO is disengaged
 - Transmission is in neutral
5. Get out and walk all around vehicle to ensure that the vehicle is at least 5 feet away from all combustible materials and no one is in the immediate vicinity.
6. Climb back into the vehicle
7. Push the Regeneration (START) Switch located on the dash for at least 4 -8 seconds and release the button to initiate a Parked Regeneration.

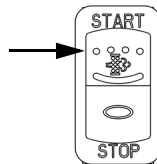



NOTE: Acknowledgment that a Parked Regeneration has initiated will vary by engine. The most predominant acknowledgement to you will be an increase in engine RPM and overall engine noise.



NOTE: The time delay between when the regeneration switch has been pushed and released and when the system starts regenerating may vary by engine. A Parked Regeneration may take 30 or more seconds to initiate as the ATS system conducts various self-checks to verify all the system requirements have been met.



NOTE: A Parked Regeneration will initiate only if the DPF status light is illuminated or blinking.

If you are unable to initiate a Parked regeneration and the DPF status light is illuminated, contact your nearest Peterbilt authorized dealer for assistance.

Stop an Automatic or Parked Regeneration

A three position switch with a START, Center, and STOP position will allow the operator to stop a regeneration. If

the regeneration switch is a two position switch, then the operator will not have the ability to stop a regeneration and this section will not apply.



WARNING! If the vehicle's regeneration switch does not have a STOP position, never allow the vehicle to remain inside a building such as a service bay, shop or building of any kind during an Automatic regeneration. Failure to do so could ignite an explosion which could result in death or serious injury to you and/or bystanders.

Vehicles with a three position switch provides the operator with the ability to STOP an Automatic or Parked Regeneration. Since Automatic Regenerations can occur at any time with this engine, you must depress the STOP portion of the Regeneration Switch ANYTIME you plan to drive your vehicle into a building, enclosure or area where the activation of a regeneration is not allowed. If the regeneration does not stop, turn the vehicle ignition OFF.



WARNING! *Never allow an Automatic regeneration to automatically start while inside a building such as a service bay, shop or building of any kind. Any time you are parking your vehicle inside a building or enclosure, ALWAYS press the Regeneration (STOP) switch prior to entering the building. Failure to do so could ignite an explosion which could result in death or serious injury to you and/or bystanders.*



WARNING! *Never initiate a Parked Regeneration in a closed building or enclosure. Always park your vehicle outside. Failure to do so could ignite an explosion which could result in death or serious injury to you and/or bystanders.*



CAUTION: *Do not leave the switch in the STOP position unless you need to cancel or stop regeneration. Leaving the switch in the STOP position for extended periods of time will result in increased soot levels in the DPF.*

Stopping The Engine Before Stopping The Engine

A hot engine stores a great amount of heat. And it doesn't cool down immediately after you shut it off. Always cool your engine down before shutting it off. You will greatly increase its service life.

Idle the engine at 1000 RPM for five minutes. Then low idle for thirty seconds before shutdown. This will allow circulating coolant and lubricating oil to carry away heat from the cylinder head, valves, pistons, cylinder liners, turbocharger, and bearings. This way you can prevent serious engine damage that may result from uneven cooling.

Turbochargers

This cooling-down practice is especially important on a turbocharged engine. The turbocharger contains bearings and seals that are subjected to hot exhaust gases. While the engine is operating, heat is carried away by circulating oil. If you stop the engine suddenly after a hard run, the temperature of the turbocharger could rise as much as

100°F (55°C) above the temperature reached during operation. A sudden rise in temperature like this could cause the bearings to seize or the oil seals to loosen.

Refuel Before the Final Stop

Air space in your fuel tanks allows water to condense there. To prevent this condensation while you are stopped, fill your tanks to 95% of capacity.



WARNING! Do not carry additional fuel containers in your vehicle. Fuel containers, either full or empty, may leak, explode, and cause or feed a fire. Do not carry extra fuel containers, even empty ones are dangerous.

- ***Diesel fuel in the presence of an ignition source (such as a cigarette) could cause an explosion. You could be killed or seriously injured. A mixture of gasoline or alcohol with diesel fuel increases this risk of explosion.***
- ***Do not remove a fuel tank cap near an open flame.***
- ***Use only the fuel and/or additives recommended for your engine.***

Final Stop

To make sure your vehicle is ready to go after a long stop (such as over night), please follow the suggestions below. Your vehicle will be easier to get going when you are ready, and it will be safer for anyone who might be around it. Please remember, too, that in some states it is illegal to leave the engine running and the vehicle unattended.

Final Stopping Procedures

1. Set the parking brake before leaving the driver's seat. To hold your vehicle while it is parked, don't rely on
 - Air Brakes
 - Hand Control Valve for Trailer Brakes
 - Engine Compression



WARNING! Using the trailer hand brake or air brakes to hold a parked vehicle is dangerous. Because they work with air pressure, these brakes could come loose. Your vehicle could roll, causing an accident involving death or personal injury. Always set the parking brakes. Never rely on the trailer hand brake or truck air brakes to hold a parked vehicle.

- If you are parked on a steep grade, block the wheels

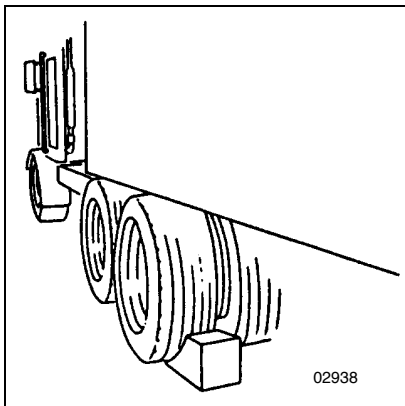

Blocked Wheels

- Drain water from the air reservoirs. While the engine and air supply system are still warm, drain moisture from the air reservoirs. Open the reservoir drains just enough to drain the moisture. Don't deplete the entire air supply. Be sure to close the drains before leaving the vehicle.

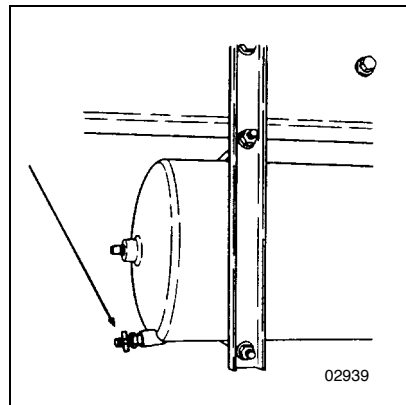

Opening Drains

- Secure the vehicle. Close all the windows and lock all the doors.

Setting Ride Height

Vehicles equipped with rear air suspensions have their ride height and axle (pinion) angle(s) preset at the factory. These are precision settings and should not be altered. Incorrectly adjusted ride height may result in improper interaxle U-joint working angles. This can result in premature driveline wear and driveline vibration. If your vehicle

is equipped with a Peterbilt rear air suspension, and if it becomes necessary to reset the ride height, you may temporarily set it by following the next procedure. Proper ride height measurement and values are shown in the illustration and table below.

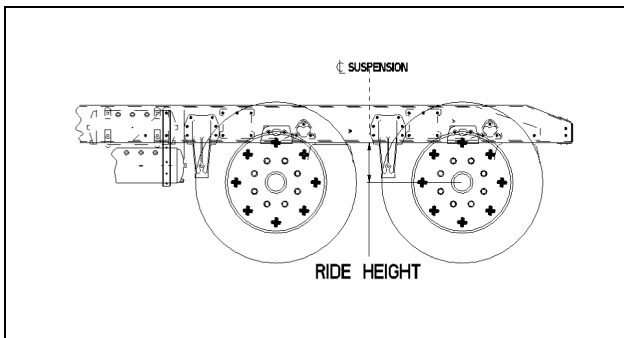

Ride Height Measurement (Tandem Axles Location)

Proprietary Rear Air Suspension	Ride Height [inches (mm)]*	
	Single Drive	Tandem Drive
Air Leaf	N/A	11.70 (297)
Air Trac	11.00 (279)	11.00 (279)
Low Air Leaf	6.50 (165)	8.50 (216)
Low Low Air Leaf	N/A	6.50 (165)
FLEX Air	N/A	8.50 (216)

*These values are for a fully laden vehicle

Follow this procedure to temporarily set ride height.



WARNING! To prevent possible death, injury and damage to property, ensure that a vehicle is parked and the wheels chocked before beginning this procedure.



CAUTION: Completing this procedure will enable you to safely reach the nearest authorized Peterbilt repair facility to have ride height and pinion angle reset using the proper equipment and technique. Do this as soon as possible to avoid potential driveline damage.



NOTE: Suitable wheel chocks are at a minimum an 18-inch (46 cm) long 4x4.

1. Ensure the air supply and delivery plumbing of the height control valve is consistent with the following illustrations:

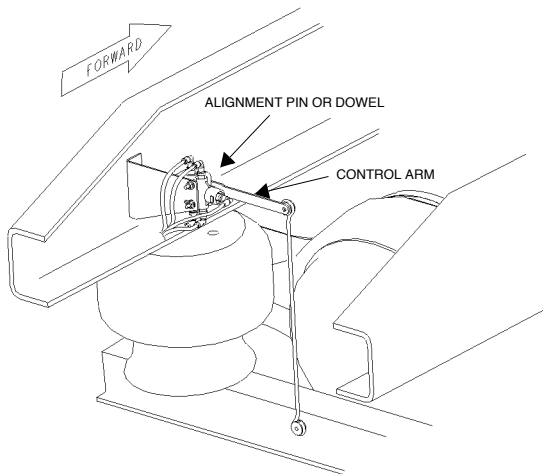

Typical Height Control Valve (Top View)

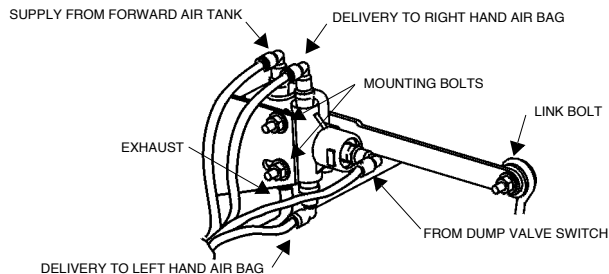

Typical Height Control Valve (Rear View Looking Forward)



NOTES:

- *At least one of the mounting holes in the height control valve bracket will be slotted to permit rotating the valve.*
 - *On dual-valve systems, begin with the LH valve on the next step.*
2. Loosen the fasteners mounting a height control valve to its bracket.



WARNING! *The rear of a vehicle will drop about 3 1/2 inches (88 mm) when the air springs are deflated. Ensure that no persons or objects that could be killed, injured or damaged are under the vehicle before deflating the air springs.*



WARNING! *To minimize risk of damage or death or injury, do not use a dump valve to deflate the air springs. Rotate the height control valve(s) manually to ensure positive control of air spring deflation.*

3. Rotate the valve either clockwise or counterclockwise until air pressure in the air springs provides the ride height specified for that suspension. Measure the ride height from the bottom of the frame rail to the approximate centerline of the rearmost drive axle hub:



WARNING! *Do not allow the air springs to overinflate. Overinflating the air springs may cause them to burst which can lead to death or personal injury from debris or the frame.*

- For tandem axles, make the vertical measurement at the centerline of the suspension (see illustration on [page 137](#)).

- For a single axle, make the measurement in front of the axle, in the area forward of the tires but not past the suspension bracket.

4. When at the correct ride height, ensure that the height control valve lever is in the neutral position, then install either the built-in alignment pin or a 1/8-inch (3 mm) dowel (see [page 138](#)).
5. Torque the mounting fasteners to 55–75 Lb. in. (6.2–8.5 N.m.).
6. Remove the alignment pin or dowel.
7. Repeat Steps 2 through 6 above for the RH valve on vehicles with a dual-valve system.

Driving With Deflated Air Springs

If an air spring is ruptured, there will be enough air pressure to drive the vehicle to a safe stop off the highway to investigate the problem.



WARNING! *Your brakes could fail if you continue driving with deflated air springs. Air escaping from the system will lower the air pressure, which could cause a spring brake to engage. The spring brake may cause your brakes to drag and burn up the linings. If you continue to operate in this condition, a fire may result which will result in equipment damage, death or personal injury.*

You can get to a repair facility if you do the following:

1. Remove the height control link connected to the axle and to the suspension air valve control arm. This will cause the air valve control arm to center in the closed position.
2. The air system can then be pumped up to normal pressure for continued operation.



WARNING! *Low air pressure could make the brakes unsafe for driving which can lead to death or personal injury. Before driving the vehicle, make sure the pressure does pump up to over 100 psi for normal brake operation. If the air pressure does not pump up to at least 100 psi, don't try to move the vehicle.*



CAUTION: *Operating a vehicle with air suspension bags either overinflated or underinflated may cause damage to driveline components. If a vehicle must be operated under such conditions, do not exceed 5 mph.*

Driving Tips And Techniques

This section covers additional driving tips and techniques on how to drive your Peterbilt more efficiently.

Coasting



WARNING! *Do not coast with the transmission in neutral or with the clutch pedal depressed—it is a dangerous practice. Without the use of the retarding power of the drivetrain, your vehicle can reach dangerous speeds. At very high speeds you may not be able to put the transmission in any gear. At high speeds you could seriously damage your vehicle or cause an accident when you put the transmission in gear. The engine speed could exceed the maximum governed speed and*

cause a serious accident due to mechanical failures which could cause death or personal injury.

Coasting with the transmission in neutral is also expensive. It causes premature failure or damage to the clutch and transmission and overloads the brake system.

Coasting with the transmission in neutral also prevents proper transmission component lubrication. During coasting the transmission is driven by the rear wheels, and the countershaft gear (which lubricates the transmission components by oil splash) will only be turning at idle speed.

Descending a Grade



WARNING! Do not hold the brake pedal down too long or too often while going down a steep or long grade. This could cause the brakes to overheat and reduce their effectiveness. As a result, the vehicle will not slow down at the usual rate. To reduce the risk of death or personal injury in an accident, before going down a steep or long grade, reduce speed and shift the transmission into a lower gear to help control your vehicle speed. Failure to follow procedures for proper downhill operation could result in loss of vehicle control.

Engine Overspeed



CAUTION: To avoid engine damage, do not let the engine rpm go beyond the maximum governed rpm—valve damage could result if overspeed conditions occur.



NOTE: Often these recommendations are secondary to maintaining an adequate and safe speed relative to the surrounding traffic and road conditions.

Operate the engine within the optimum engine rpm range and do not allow the rpm's to exceed the maximum governed speed. See your *Engine Operation and Maintenance manual* for information regarding engine rpm. When the engine is used as a brake to control vehicle speed (e.g., while driving down a grade), do not allow the engine rpm to exceed maximum governed speed. Under normal load and road conditions operate the engine in the lower end of the range.

Use of Tachometer

The tachometer is an instrument that aids in obtaining the best performance of the engine and manual transmission, serving as a guide for shifting gears.

Refer to the *Engine Operation and Maintenance manual* for optimum engine rpm.

- If the engine rpm exceeds the maximum governed speed, apply the service brake or shift to a higher gear to lower engine rpm.
- When driving downhill: shift to a lower gear, use the engine brake (if so equipped), and use the service brake, keeping the engine speed below 2,100 rpm.



NOTE: Vehicles with an Eaton Ultrashift® Transmission mated to a Caterpillar or Cummins Engine will automatically shift to a higher gear (even in manual mode) if an engine over-speed condition exists.

When the engine speed reaches its maximum governed speed, the injection pump governor cuts off fuel to the engine. However, the governor has no control over the engine rpm when it is being driven by the vehicle's transmission, for example, on steep downgrades. Apply service brakes or shift to a higher gear.

Fuel economy and engine performance are also directly related to driving habits:

- The best results in trip time and fuel economy are obtained while driving the vehicle at a steady speed.
- Shift into higher or lower gears (or apply the service brake) to keep engine rpm near the lower end of the optimum operating range.
- Avoid rapid acceleration and braking.

PART 8: MAINTENANCE AND SERVICE

Preventive Maintenance Schedule

Your preventive maintenance program begins with the daily checks you perform. See [“PART 6: DRIVER’S CHECKLIST”](#) for these. If you check your Peterbilt vehicle regularly, you can avoid many large, expensive, and time-consuming repairs. Your vehicle will operate better, be safer, and last longer. Neglect of recommended maintenance may in some cases void your vehicle’s warranty. So for your safety and the life of your vehicle, please follow the Maintenance Schedule. Remember - there may be maintenance operations that demand skills and equipment you don’t have. If so, please take your vehicle to an expert mechanic, for your safety and your vehicle’s safety.



WARNING! It can be dangerous to attempt maintenance work without sufficient training, service manuals, and the proper tools. You could be killed, injured or you could make your vehicle unsafe. Do only those tasks you are fully trained and equipped to do.

- ***Before attempting any procedures in the engine compartment, stop the engine and let it cool down. Hot components can burn skin on contact.***
- ***Be alert and cautious around the engine at all times while the engine is running***
- ***If work has to be done with the engine running, always (1) set the parking brake, (2) chock the wheels, and (3) ensure that the shift lever or selector is in Neutral.***
- ***Exercise extreme caution to prevent neckties, jewelry, long hair, or loose clothing from getting caught in the fan blades or any other moving engine parts.***

- **Disconnect the battery ground strap whenever you work on the fuel system or the electrical system. When you work around fuel, do not smoke or work near heaters or other fire hazard. Keep an approved fire extinguisher handy.**
- **Always support the vehicle with appropriate safety stands if it is necessary to work underneath the vehicle. A jack is not adequate for this purpose.**
- **When working underneath the vehicle without appropriate safety stands but with the wheels on the ground (not supported), make sure that (1) the vehicle is on hard level ground, (2) the parking brake is applied, (3) all wheels are chocked (front and rear) and (4) the engine cannot be started. Remove the ignition key.**

- **Never start or let the engine run in an enclosed, unventilated area. Exhaust fumes from the engine contain carbon monoxide, a colorless and odorless gas. Carbon monoxide can be fatal if inhaled.**



NOTE: Suitable wheel chocks are at a minimum an 18-inch (46 cm) long 4x4.

I	A	B	C	D	E
At the first 15,000 mi./ 24,000 km or at the first PM	15,000 mi./ 24,000 km/ Monthly	30,000 mi./48,000 km	60,000 mi./ 96,000 km/6 months	120,000 mi./ 192,000 km/Annu- ally	240,000 mi./ 384,000 km

**NOTES:**

- *Where questions or discrepancies develop between these recommendations and component supplier recommendations, consult the supplier for specific recommendations.*
- *Maintenance requirements of specific vocational configurations will dictate whether the intervals used are determined based on mileage, time in service, hours operating, etc.*
- *These maintenance practices and intervals are intended as additional requirements and are not to replace, in whole or in part, the pretrip inspection requirements of the Commercial Driver's License (CDL) as established in the Federal Commercial Motor Vehicle Safety Act of 1986.*

If you operate your vehicle off-highway or in very heavy-duty applications such as mining, logging, or earth moving, you will need to perform maintenance checks and ser-

vices more frequently. The charts on the following pages show the maintenance intervals for recommended maintenance practices.

**NOTES:**

- *Engine lubricating oil change intervals aren't listed here. Refer to your engine's operating manual for recommendations. For specific information on maintenance procedures, consult your vehicle maintenance manual.*
- *The initial fill of drive axle lubricant must be changed before the end of the first scheduled maintenance interval. Refer to the information on [page 169](#) before you put a new vehicle into service.*
- *The initial fill of lubricant in manual transmissions must be changed before the end of the first maintenance interval. See [page 165](#) for specific information.*

Table 2 Preventative Maintenance Schedule

SYSTEM	COMPONENT	MAINTENANCE TASK	Recommended PM Interval					
			I	A	B	C	D	E
Frame	Fifth Wheel	Check the kingpin lock and plate for wear and function; lubricate (NLGI #2 grease).		X				
	Frame Fasteners	Check for tightness; tighten to the specified torque value as required (see page 208).					X	
	Crossmembers and Mounting Brackets	Inspect for cracks and loose fasteners. Replace or tighten to the specified torque value as required (see page 208).					X	
Front Axle	Steering knuckles, thrust bearings, kingpins, drawkeys, tie rod ends, steering stops, & bushings	Inspect for wear and damage and for endplay. Shim or replace as required (see page 207).					X	
	Kingpin bushings & tie rod ball ends	Lubricate with approved grease.				X		
	Total Vehicle Alignment	Check and adjust as required.	X				X	
	Drawkeys	Tighten nuts	X		X			
Front Suspension	Front Spring	Inspect for cracked leaves, worn bushings, & excessive corrosion.				X		
	Spring Pins & Shackles	Inspect for worn parts and excessive joint clearance. Shim or replace as required.				X		
	Spring Pins	Lubricate.			X			

Table 2 Preventative Maintenance Schedule (Continued)

SYSTEM	COMPONENT	MAINTENANCE TASK	Recommended PM Interval					
			I	A	B	C	D	E
Front Suspension	Shock Absorbers	Inspect for leaking, body damage, and damaged or worn bushings. Replace as required.				X		
	Shock Absorbers	Check for proper function.		X				
	U-bolts (ON HIGHWAY)	Check the general condition and the tightness of the nuts. Tighten the nuts to the specified torque value as required (see page 207).	X			X		
	U-bolts (OFF HIGHWAY)	Check the general condition and the tightness of the nuts. Tighten the nuts to the specified torque value as required (see page 207).		X				
Drive Axle (Dana)	Axle Housing	Visually inspect for damage or leaks.				X		
		Check oil level. Check "cold." Torque the drain plug.				X		
		Drain the lubricant while warm. Flush each unit with clean flushing oil. Change the lubricant.	See information on page 170					
	Air Shift Unit	Check the lubricant level.				X		
		Remove the housing cover and drain the lubricant. Wash the parts thoroughly and dry in air.					X	
	Breather	Clean or replace.					X	
	Lube Pump (ON HIGHWAY)	Remove the magnetic strainer and inspect for wear particles. Wash in solvent and dry in air.					X	
Lube Pump (OFF HIGHWAY)	Remove the magnetic strainer and inspect for wear particles. Wash in solvent and dry in air.				X			

Table 2 Preventative Maintenance Schedule (Continued)

SYSTEM	COMPONENT	MAINTENANCE TASK	Recommended PM Interval					
			I	A	B	C	D	E
Drive Axle (Dana)	Lube Filter (ON HIGHWAY)	Change.					X	
	Lube Filter (OFF HIGHWAY)	Change.				X		
	Magnetic drain plug and breather (ON HIGHWAY)	Clean or replace.					X	
	Magnetic drain plug and breather (OFF HIGHWAY)	Clean or replace.				X		
Drive Axle (Meritor)	Axle Housing	Check the “cold” fill level at the differential carrier plug for a pinion angle of less than 7 degrees, or at the axle bowl plug for a pinion angle of greater than 7 degrees. Tighten the plug to 35 - 50 Lb. ft. (47 - 68 N.m.)				X		
	Axle Housing	Visually inspect for damage or leaks.				X		
	Axle Housing	Drain and replace the lubricant.	See information on page 169					
	Lubricant filter	Change the filter.					X	
	Breather	Check the operation. If the cap doesn’t rotate freely, replace.				X		
	Input shaft & pinion shaft	Check and adjust the endplay.					X	
	Axle shaft	Tighten the rear axle flange nuts to the specified torque value.					X	
	Interaxle differential	Check the operation.					X	

Table 2 Preventative Maintenance Schedule (Continued)

SYSTEM	COMPONENT	MAINTENANCE TASK	Recommended PM Interval					
			I	A	B	C	D	E
Rear Suspension	U-bolts	Check the torque. Tighten to specified torque value as required (see page 207).	X			X		
	Frame & crossmember bolts	Check the torque. Tighten to specified torque value as required (see page 208).					X	
	Mounting brackets and fasteners	Check the condition and the fastener torque. Tighten to the specified torque value as required (see page 208).	X				X	
Drum Brakes (All)	Slack adjusters	Check the push rod travel and check the control arm for cracks. Adjust at reline (see page 173).		X				
		Lubricate (NLGI #2 grease).		X				
	Brake camshaft bearing	Lubricate (NLGI #2 grease).				X		
		Check for excessive cam shaft play in the axial and radial directions. Max allowable play is 0.003".				X		
	Brake treadle valve	Clean the area around the treadle, boot, and mounting plate. Check the pivot and mounting plate for integrity. Check the plunger boot for cracks. Lubricate roller pin, pivot pin, and plunger (NLGI #2 grease).				X		
	Brake air system	Check air lines and fittings for leaks (see page 173). Adjust routing as required to reduce chafing. Check tank mounting and condition.		X				
	Brake air system	Clean or replace the inline filters.				X		
	Brake lining	Inspect; replace as required.			X			

Table 2 Preventative Maintenance Schedule (Continued)

SYSTEM	COMPONENT	MAINTENANCE TASK	Recommended PM Interval					
			I	A	B	C	D	E
Disc Brakes (All)	Brake pads	Inspect; replace as required.				X		
	Brake disc/rotor	Inspect for visible cracks, heat checking, galling, or scoring of surface. Check thickness minimum of 1.46" (37 mm).				X		
	Caliper sliding function	Ensure caliper slides freely with no obstructions or excessive play (see manufacturer's service literature for "Checking Running Clearance").				X		
	Caliper function	Inspect bearings, seals, tappet and boots of the guide pins for damage or cracking.				X		
	Adjuster	Check operation; inspect as per manufacturer's service literature.				X		
Hub, Drum, & Hubcap	Hubs (non-LMS)	Check the bearing endplay and adjust as required (see page 185).			X			
	Hubs (non-LMS) with outrunner seals	Clean the components and check for excessive wear or damage. Change the oil and seal (see page 185).						X
	Hubs (non-LMS) with standard seals	Clean the components and check for excessive wear or damage. Change the oil and seal (see page 185).					X	
	Hub seals (all)	Check for leaks; replace as required.			X			
	LMS Hubs (Dana)	Check the bearing endplay and adjust as required (see page 185).					X	
	LMS Hubs (Dana) with Synthetic Lubricant	Clean the components and check for excessive wear or damage. Change the oil and seal (see page 185).	500,000 miles/ 800,000 km					

Table 2 Preventative Maintenance Schedule (Continued)

SYSTEM	COMPONENT	MAINTENANCE TASK	Recommended PM Interval					
			I	A	B	C	D	E
Hub, Drum, & Hubcap	LMS Hubs (Dana) with Mineral Lubricant	Clean the components and check for excessive wear or damage. Change the oil and seal (see page 185).	360,000 miles/ 576,000 km					
	Brake drums	Inspect for visible cracks, heat checking, galling or scoring of the braking surface, and for severe corrosion on the outside surface. Check for out-of-round or oversize condition [0.080 in. (2 mm) more than the original diameter]. Replace as required.			X			
	Hubcaps	Clean the sight window. Check the center plug, mounting flange, and fill plug for leaks and for proper installation. Replace broken or damaged parts. Check the lubricant level and add as required.		X				
Main & auxiliary transmission	Main & auxiliary transmission and transfer case	Inspect for visible damage, signs of overheating, and leaks.	X	X				
	Main & auxiliary transmission and transfer case	Check the drain plugs for tightness.			X			
	Oil cooler	Clean the fins (air-to-oil type) and body. Check the hose condition and for leaks; replace as required.				X		
Main & auxiliary transmission (Dana)	Main & auxiliary transmission	Check the oil level; refill as required (see page 165 and page 167).			X			
	Main & auxiliary transmission (ON HIGHWAY)	Drain the lubricant while warm. Flush each unit with clean flushing oil.	500,000 miles/ 800,000 km					
	Main & auxiliary transmission (OFF HIGHWAY)	Drain the lubricant while warm. Flush each unit with clean flushing oil.	X			X		

Table 2 Preventative Maintenance Schedule (Continued)

SYSTEM	COMPONENT	MAINTENANCE TASK	Recommended PM Interval					
			I	A	B	C	D	E
Main & auxiliary transmission (Meritor)	Transfer Case	Check the oil level; refill as required (see page 169).	X	X				
		Drain lubricant while warm. Flush each unit with clean flushing oil.			X			
Air Intake	Air intake piping, mounting, and charge air cooler	Check the system for broken pipes, leaks, joint integrity, cleanliness, and proper support (see page 212).				X		
	Engine air intake tubing	Disassemble, clean, check for cracks, leaks, and joint integrity.					X	
	Cold starting aids	Check for leaks and proper operation (see page 94).					X	
	Air cleaner	Replace the element as indicated (see page 212).	When required by the air restriction indicator					
Clutch	Clutch pedal shaft	Check for excessive looseness and lubricate (NLGI #2 grease).		X				
	Clutch pedal	Check for proper pedal free travel (see page 203).		X				
	Clutch release linkage	Check for excessive looseness and lubricate (NLGI #2 grease).		X				
	Clutch release bearing	Lubricate.		X				
	Clutch release shaft	Lubricate.		X				
Cooling	Components	Check the radiator and heater hoses for leaks.	X			X		
	Radiator Pressure Cap	Check radiator pressure cap	X	X	X	X	X	

Table 2 Preventative Maintenance Schedule (Continued)

SYSTEM	COMPONENT	MAINTENANCE TASK	Recommended PM Interval					
			I	A	B	C	D	E
Cooling	System (ELC)	Check the freeze point (see page 191).			X			
		Check for contamination using test strips (see page 192).			X			
		Replace blank water filter if applicable.					X	
		Perform lab analysis of coolant to determine suitability for continued use (see page 192).					X	
		Flush, drain, and refill with new coolant if lab analysis shows coolant is unsuitable for continued use(see page 194).					X	
		Add ELC Extender if lab analysis shows coolant is suitable for continued use (see page 192).					X	
		Flush, drain, and refill with new coolant (see page 194).						X
	Fan clutch	Check for leaks.	X			X		
		Check the fan drive bearings (turn the sheave in both directions to check for worn hub bearings).	X			X		
	Solenoid Valve	Check the fan drive for proper engagement and disengagement.	X			X		
Tires & Wheels	Tires	Check inflation pressure (see page 178).	Weekly "cold" using calibrated gauge					
	Tires	Inspect for cuts, irregular wear, missing lugs, sidewall damage, etc.		X				

Table 2 Preventative Maintenance Schedule (Continued)

SYSTEM	COMPONENT	MAINTENANCE TASK	Recommended PM Interval					
			I	A	B	C	D	E
Tires & Wheels	Disc wheels	Inspect the wheel disc for any cracks or surface irregularities. Inspect the rim edge and bead seat area for damage. Replace any damaged wheels - DO NOT ATTEMPT TO REPAIR.		X				
	Demountable rims	Inspect the mounting ring, rim gutter, side ring, and lock ring for damage; replace as required.		X				
	Wheel nuts and studs	Check the tightness of the fasteners and tighten the fasteners to the specified torque as required (see page 185).		X				
	Wheel nuts and studs	Inspect for damaged hex corners, stripped or damaged threads, and excessive corrosion; clean or replace as required.		X				
Power Steering	Reservoir	Check the fluid level (see page 171).		X				
	Reservoir (ON HIGHWAY)	Drain, replace the filter, and refill (see page 171).	X				X	
	Reservoir (OFF HIGHWAY)	Drain, replace the filter, and refill (see page 171).	X			X		
	Steering gear	Check the lash of the sector shaft; adjust as required.				X		
	Steering gear	Grease the trunion bearing (EP NLGI #2 lithium-based, moly-filled, HD grease).				X		
	Steering gear	Grease the input shaft seal (EP NLGI #2 lithium-based, moly-filled, HD grease).				X		
	Power assist cylinder	Lubricate the ball joints. Inspect for leaking rod seals, damaged ball joint boots, and damage to cylinder rod or barrel.		X				
	Hoses and tubes	Check for leaks and chafing.				X		

Table 2 Preventative Maintenance Schedule (Continued)

SYSTEM	COMPONENT	MAINTENANCE TASK	Recommended PM Interval					
			I	A	B	C	D	E
Power Steering	Steering linkage	Check all joints for excessive lash; replace as required (see page 207).					X	
	Draglink tube clamp and ball socket	Check the torque; tighten to specified torque value as required.	X			X		
	Pitman arm clamp bolt and nut	Check the torque; tighten to specified torque value as required.	X			X		
	Steering intermediate shaft	Check the torque on the pinch bolt and nut.	X			X		
	Steering intermediate shaft U-joints (ON HIGHWAY)	Lubricate [EP NLGI #2 HD grease, +325° F to -10° F (+163° C to -23° C) range].	X			X		
	Steering intermediate shaft U-joints (OFF HIGHWAY or CITY DELIVERY)	Lubricate [EP NLGI #2 HD grease, +325° F to -10° F (+163° C to -23° C) range].	X		X			
	Draglink and tie rod arm ball sockets (ON HIGHWAY)	Lubricate (EP NLGI #2 lithium-based, moly-filled, HD grease).	X		X			
	Steering intermediate shaft U-joints (OFF HIGHWAY or CITY DELIVERY)	Lubricate (EP NLGI #2 lithium-based, moly-filled, HD grease).	X	X				
Fuel & Tanks	Fuel tanks	Inspect tanks, brackets, hoses, and fittings for correct location, tightness, abrasion damage, and leaks; repair or replace as required.				X		
	Fuel tank breathers	Check for proper function; clean the drain hoses.					X	

Table 2 Preventative Maintenance Schedule (Continued)

SYSTEM	COMPONENT	MAINTENANCE TASK	Recommended PM Interval					
			I	A	B	C	D	E
Fuel & Tanks	Fuel tank straps	Tighten to proper torque value of 45 - 70 Lb. ft. (61 - 95 N.m.); *check annually once strap tension reaches a steady state; i.e., after 2 - 3 retorquings, the measured torque is the same as previous reading.	X		X		*	
Driveshafts	Models 1610-1810 & SPL-90	Lubricate slip member & U-joints	X	X				
	Model SPL-100	Lubricate slip member & U-joints				X		
	Models SPL-140/140HD/170/170HD/250/250HD	Lubricate slip member & U-joints				X		
	Models SPL-140XL/170XL/250XL (ON HIGHWAY & LINE HAUL)	Lubricate slip member & U-joints	360,000 miles/ 576,000 km/ every 3 years					
	Models SPL-140XL/170XL/250XL (OFF HIGHWAY & CITY)	Lubricate slip member & U-joints					X	
Battery	Battery cables	Check the condition of the cables, cushion clamps, and routing. Replace a cushion clamp if the rubber has deteriorated. Repair or tighten terminals, and secure cables to prevent chafing. Replace damaged cables (cuts, cracks, or excessive wear) (see page 195).	X			X		
	Batteries	Check for cracks and damage, electrolyte level, condition of terminals, and tightness of holddowns (see page 195).				X		

Table 2 Preventative Maintenance Schedule (Continued)

SYSTEM	COMPONENT	MAINTENANCE TASK	Recommended PM Interval					
			I	A	B	C	D	E
Battery	Battery box and tray	Check the box integrity. Clean the drain tube and check for acid leaks. Check condition of all equipment mounted under the box.				X		
Electrical & lights	Headlamps	Check the aim and adjust as required.				X		
	Warning lights in light bar	Check at the ignition start position to verify bulbs and Driver Information Display function.		X				
	Turn signal	Visual check.		X				
	Stop lights	Visual check.		X				
	Reverse lights	Visual check.		X				
	Alternator	Check operation and output.					X	
		Check tightness of the pulley nut.					X	
		Check the tension of the drive belt (see page 210).					X	
		Check tightness of the terminal hex nuts.					X	
	Starter	Check torque on hex nuts.				X		
	ECM connector	Check the tightness of the ECM connector.				X		
	Wheel sensors	Check for damaged sensors and connectors, and worn or frayed wires.				X		
	Fuel and Diesel Exhaust Fluid tank sending unit	Check the mounting screws and electrical connections for worn or damaged wires and connectors.	X		X			

Table 2 Preventative Maintenance Schedule (Continued)

SYSTEM	COMPONENT	MAINTENANCE TASK	Recommended PM Interval					
			I	A	B	C	D	E
Electrical & lights	Power supply harnesses (engine, transmission, etc.)	Check for worn or damaged insulation, corroded terminals, frayed wires, and oil or fluid leaks on the connectors or wiring.		X				
	Power supply harnesses (engine, transmission, etc.)	Wash to remove excess grease.				X		
Cab structure, doors, & hoods	Hood	Lubricate the lower hood pivot (only if lube fittings are present).				X		
	Hinges and latch	Lubricate with silicone spray.				X		
	Body & cab holddown bolts	Check the condition and tightness.					X	
Heating & Air Conditioning	Air conditioner	Operate the system. (NOTE: The air conditioning system is active when the Defrost/Defog mode is selected.)		X				
	Heater & air conditioner	Perform the checks listed on page 215 .			X			
		Full operational and diagnostic check.					X	
	Cab air filter	Clean; replace after a maximum of three cleanings.				X		
	Condenser	Clear any debris from the front of the condenser.				X		
Aftertreatment System	System	Check for leaks and proper support (see page 213).		X				
	Flexible pipe	Replace the main and ancillary exhaust flexible pipe.						150,000 mi/241,401 Km

Table 2 Preventative Maintenance Schedule (Continued)

SYSTEM	COMPONENT	MAINTENANCE TASK	Recommended PM Interval					
			I	A	B	C	D	E
Aftertreatment System	Diesel Particulate Filter	Clean Filter.	Refer to the engine maintenance manual					
	Diesel Exhaust Fluid Tank	Check fittings for abrasion damage, leaks, tightness and fully engaged connectors				X		
	Diesel Exhaust Fluid Supply Module	Replace Filter (See page page 205)				X		
Air	Air compressor governor	Replace air strainer.			X			
	Air lines	Check condition and routing to prevent chafing.			X			
	System	Lubricate (see page 188).				X		
	Inline filters	Replace elements or clean with solvent.				X		
	Air dryer	Perform the checks listed on page 190 .			X			
	Air dryer (ON HIGHWAY)	Overhaul.	360,000 miles/ 576,000 km					
	Air dryer (OFF HIGHWAY)	Overhaul.					X	

Table 2 Preventative Maintenance Schedule (Continued)

SYSTEM	COMPONENT	MAINTENANCE TASK	Recommended PM Interval					
			I	A	B	C	D	E
Engine	Basic Engine	The maintenance and service interval recommendations for the specific engine are the maintenance requirements specified in the engine manufacturer's Operations and Maintenance Manual included with the vehicle. Strict adherence to these recommendations is required to maintain warranty coverage. The maintenance and service interval recommendations for the engines vary significantly, depending on the manufacturer and the model of the engine. As a <u>minimum</u> , perform the operations listed below:						

Lubricant Specifications



WARNING! Handle lubricants carefully. Vehicle lubricants (oil and grease) can be poisonous and cause death, injury or sickness. They can also damage the paint on the vehicle.

In this section you will find the basic information you need to do the routine lubrication your vehicle requires. Of course you will want to schedule service more frequently if you are operating under severe conditions such as extreme heat or cold, with very heavy loads, off-road, etc. For any special service requirements, consult your service manuals and your lubricant supplier. And please remember: one key to keeping your truck running at top economy and in prolonging its life is proper lubrication servicing. Neglecting this essential aspect of vehicle care can cost time and money in the long run.



CAUTION: Do not mix different types of lubricants. Mixing lubricants (oil and grease) of different brands or types could damage vehicle components; therefore, drain (or remove) old lubricants from the unit before refilling it.

Engine



NOTE: The engine in this vehicle may comply with EPA emission standards. Consult the engine manufacturer's manual for changed lubrication and maintenance requirements.

Proper engine lubrication depends on the outside temperatures where you will be driving. Use the oil recommended for the conditions you are most likely to be facing. You will find a complete engine lubrication service guide in the Engine Operation Manual that came with your vehicle. There, the engine manufacturer explains more fully all the maintenance operations that you and a qualified service mechanic need to perform on your engine.



WARNING! Exhaust fumes from the engine contain carbon monoxide, a colorless and odorless gas. Do not breathe the engine exhaust gas. A poorly maintained, damaged or corroded exhaust system can allow carbon monoxide to enter the cab or sleeper. Entry of carbon monoxide into the cab is also possible from other vehicles nearby. Failure to properly maintain your vehicle could cause carbon monoxide to enter the cab/sleeper and cause death or serious illness.



WARNING! Never idle your vehicle for prolonged periods of time if you sense that exhaust fumes are entering the cab or sleeper. Investigate the cause of the fumes and correct it as soon as possible. If the vehicle must be driven under these conditions, drive only with the windows slightly open. Failure to repair the source of the exhaust fumes may lead to death or personal injury.



NOTES: Keep the engine exhaust system and the vehicle's cab/sleeper ventilation system properly maintained. It is recommended that the vehicle's exhaust system and cab/sleeper be inspected

- By a competent technician every 15,000 miles/24,000 km.
- Whenever a change is noticed in the sound of the exhaust system.
- Whenever the exhaust system, underbody, cab or sleeper is damaged.



NOTE: Use only exact replacement components in exhaust systems. Certain components contain integral catalytic converters essential for compliance with EPA emission standards. Using noncompliant components as a replacement could violate these standards and also void the emission system's warranty.



WARNING! Hot engine oil can be dangerous. You could be seriously burned. Let the engine oil cool down before changing it.

Master Lubrication Index

Table 3 Lubricant Symbol Key	
ATF	Dextron III/Mercon approved Automatic Transmission Fluid
BB	Ball Bearing grease
CB	Engine oil for mild to moderate requirements
CC/CD	Engine oil for severe requirements (MIL-L-2104B /MIL-L-45199B w/ 1.85% max. sulfated ash content)
CD	Engine oil meeting API "Five engine test sequence"
CD50	SAE50W synthetic transmission fluid
CE	Engine oil meeting severe duty service requirements for direct-injection turbocharged engines
CJ-4	Engine oil

Table 3 Lubricant Symbol Key	
CL	Multipurpose chassis grease
C4	Type C4 transmission fluid (torque fluid)
EP	Extreme Pressure Lubricant
GL	Straight mineral gear lubricant
HD	Hypoid Gear Oil, A.P.I. - GL-5, SAE 80W-90
HT	High Temperature grease (Timken Spec. 0-616)
MP	Multipurpose gear lubricant (MIL-L-2105B)
WB	Wheel Bearing grease (Timken Spec. 0-610)



NOTE: The responsibility for meeting these specifications, the quality of the product, and its performance in service rests with the lubricant supplier.

Universal Joints	EP
Drive Shaft Splines	CL
Wheel Bearings (driven hubs)	HD
Wheel Bearings (nondriven hubs)	CD50
Wheel Bearings (all grease-lubricated hubs)	WB
Steering Column	CL
Alternator Bearing	BB*
Fan Hub	BB*
Power Steering Reservoir	ATF
Steering Drag Link	CL
Steering Knuckles	CL
Spring Pins	CL

Clutch Release Bearings	BB
Brake Shoe Anchor Pins	HT
Brake Cam Bearings	HT
Slack Adjusters	CL
Water Pump	BB*
Cab Tilt Hydraulic Reservoir	Hydraulic Jack Oil, MIL-L-5056B
Speedometer Cables	Lubriplate Aero or equivalent
*Consult manufacturer or lubricant supplier for special details	

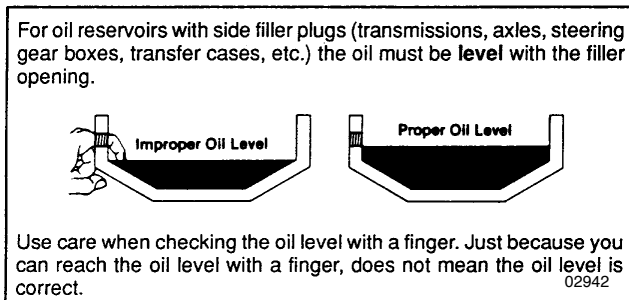

Fuller Transmission Lubrication

Fuller transmissions are designed so that the internal parts operate in a bath of oil circulated by the motion of gears and shafts. Grey iron parts have built-in channels where needed to help lubricate bearings and shafts. All parts will be amply lubricated if these procedures are closely followed:

1. Maintain oil level; check it regularly.

2. Change oil regularly.
3. Use the correct grade and type of oil.
4. Buy oil from a reputable dealer.

Lubrication Change and Inspection

Off-Highway Use

Refer to the Eaton Fuller transmission manual for servicing information.

Highway Use

- Refer to the Eaton Fuller transmission manual for servicing information.
- Refer to the oil change vs. temperature chart that follows for special oil change information. The “intermittent peak temperature” is the maximum temperature observed for a short time in a fully loaded vehicle performing normally.

Oil Change vs Temperature For On-Highway Vehicles

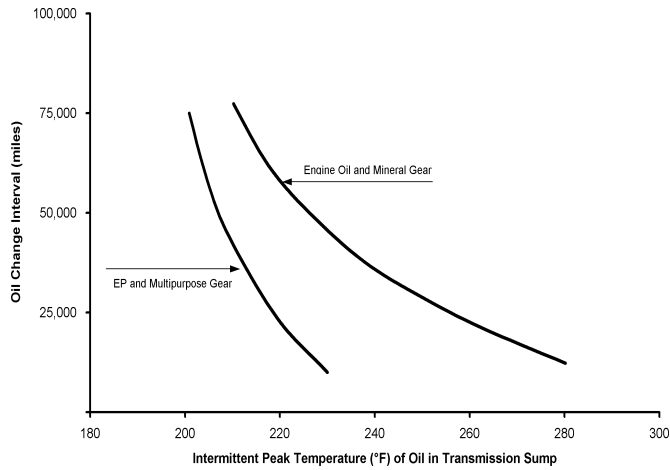

CAUTION: Exceeding the recommended oil change intervals may be harmful to the life of the transmission and the transmission oil cooler.

Recommended Lubricants

Table 5 Recommended Lubricants

Type	Grade (SAE)	Ambient Temperature
Heavy Duty Engine Oil MIL-L-2104B, C, or D; API - SF, or API-CD (Previous API designations are acceptable)	50	Above 10° F (-12° C)
	40	Above 10° F (-12° C)
	30	Below 10° F (-12° C)
Mineral gear oil with rust and oxidation inhibitor API-GL-1	90	Above 10° F (-12° C)
	80W	Below 10° F (-12° C)
Synthetic Lubricant*	50	All
* See your Peterbilt dealer for approved brands.		

Spicer Transmission Lubrication

It is extremely important to use the proper lubricants and maintain the correct oil levels in Spicer units. This will ensure proper lubrication and operating temperatures in these units.

Recommended Lubricants

The lubricants listed below are recommended, in order of preference, for use in all Spicer mechanical transmissions, auxiliaries, and transfer cases. Do not use extreme pressure additives such as those found in multipurpose or rear axle-type lubricants. These additives are not required in Spicer transmissions, and may in some cases create transmission problems. Multipurpose oils, as a group, have relatively poor oxidation stability, a high rate of sludge formation, and a greater tendency to react with or corrode the steel and bronze parts.

Table 6 Recommended Lubricants

Type	Grade (SAE)	Ambient Temperature
Heavy Duty Engine Oil MIL-L-2104D or MIL-L-46152B, API-SF or API-CD (MIL-L-2104B or C or MIL-L-46152 designations are acceptable)	30, 40, or 50	Above 0° F (-18° C)
	30	Below 0° F (-18° C)
Mineral gear oil (R & O type) API-GL-1	90	Above 0° F (-18° C)
	80	Below 0° F (-18° C)
Synthetic Engine Oil meeting MIL-L-2104D or MIL-L-46152B, API-SF or API-CD	CD50 CD30	All
*Synthetic Gear Oil Meeting MIL-2105C or API-GL5	EP75W90 EP75W140	All
*EP Gear Oils are not recommended when lubricant operating temperatures are above 230° F (110° C).		

Oil Changes



CAUTION: When adding oil, types and brands of oil should not be intermixed because of possible incompatibility, which could decrease the effectiveness of the lubrication or cause component failure.

An initial oil change and flush should be performed after the transmission has been placed in actual service. This change should be made any time after 3000 miles (4800 km) but never longer than 5000 miles (8000 km) of over-the-road service. In off-highway use, the change should be made after 24 hours but before 100 hours of service have elapsed.

Refilling

Remove all dirt around filler plug. Refill with new oil of the grade recommended for the existing season and prevailing service. Fill to the bottom of the level testing plug positioned on the side of the transmission. **Do not** overfill the transmission. Overfilling usually results in oil breakdown due to excessive heat and aeration from the churning action of the gears. Early breakdown of the oil will result in heavy varnish and sludge deposits that plug up oil ports and build up on the splines and bearings. Overflow of oil can also escape onto clutch or parking brakes. When adding oil, **do not** mix different types of oil.

Meritor Axle Lubrication



NOTE: Axles utilized in 100% off-highway use are not eligible for Meritor's Advanced Lube Rear Drive Axle program.

Under Meritor's Advanced Lube Rear Drive Axle program, the axles listed below are exempt from an initial lubricant change:

RS-17-145	RS-23-180	RT-40-145	RT-44-145P
RS-19-145	RS-26-180	RT-40-145P	RT-46-160
RS-21-145	RS-30-180	SQ-100A	RT-46-160P
RS-23-160	RT-34-145	SQ-100AP	RT-52-160
RS-23-161	RT-34-145P	RT-44-145	RT-52-160P

Meritor rear axles that do not appear on the list above will continue to require an initial drain at 3000-5000 miles (4800-8000 km).

- Refer to the Meritor Field Maintenance Manual for a particular axle for lubricant specifications.
- See your Peterbilt dealer for Meritor-approved lubricant brands.

- Refer to the following chart for lubricant change intervals:

Table 8 Lubricant Change Intervals

Application	Type Of Lubricant	Mileage Interval
Linehaul	Synthetic	240,000 mi. (384,000 km)
	Synthetic with Pump and Filter	500,000 mi. (800,000 km)
	Mineral Base	120,000 mi. (192,000 km)
City Delivery	Synthetic	120,000 mi. (192,000 km)
	Synthetic with Pump and Filter	240,000 mi. (384,000 km)
	Mineral Base	120,000 mi. (192,000 km)
Vocational	Synthetic	120,000 mi. (192,000 km)
	Synthetic with Pump and Filter	120,000 mi. (192,000 km)
	Mineral Base	120,000 mi. (192,000 km)

- Change the lubricant filter every 120,000 miles (192,000 km). Top off the lubricant level with a similar lubricant.

Eaton/Dana Axle Lubrication

- The original mineral-based lubricant must be drained within 3000-5000 miles (4800-8000 km) on all Eaton axles. This initial change is very important because it flushes out break-in contaminants that might otherwise cause premature wear.
- No initial drain is required on Eaton axles that are factory filled with an Eaton-approved synthetic lubricant.
- Mineral-based lubes must be drained within the first 5000 miles (8000 km) if converting to an Eaton-approved synthetic lube.
- Change the lubricant within the first 5000 miles (8000 km) of operation after a carrier head replacement, regardless of the lubricant type.
- Refer to the Eaton Field Maintenance Manual for a particular axle for lubricant specifications.
- See your Peterbilt dealer for Eaton-approved lubricant brands.
- Refer to the chart below for lubricant change interval.

Table 9 Eaton/Dana Axle Lubricant Change Intervals

Type of Lubricant	On-Highway Mi.(km)	Maximum Change Interval	On/Off Highway Severe Service Mi.(km)	Maximum Change Interval
Mineral-Based	120,000 (192,000)	Yearly	60,000 (96,000)	Yearly
Eaton-Approved Synthetic	240,000 (384,000)	2 Years	120,000 (192,000)	Yearly
Eaton-Approved Synthetic in axle with extended drain interval option	360,000 (576,000)			

Wheel Bearing Lubrication

Oil-lubricated Driven Hubs

Use hypoid oil, A.P.I.-GL-5 SAE 80W-90 or equivalent. A minimum of 1 quart (921 ml) of oil is required for proper lubrication of each drive hub. Add oil through the filler hole in the hub; if none, add oil through the differential filler hole. (Note: Remember to replace vent plug or threaded filler plug when done.) Allow time for the oil to seep

through the bearings when initially filling a hub. Maintain the differential oil level by adding oil until its surface is even with the bottom of the filler hole (see [page 165](#)).

Oil-lubricated Nondriven Hubs

Use CD50 synthetic transmission fluid SAE 50W or equivalent. A minimum of 9 oz. (270 ml) of lubricant is required for proper lubrication of an LMS™ hub; 10 - 13 oz. (295 - 400 ml) is required for a non-LMS hub, depending on wheel design. Allow time for the fluid to seep through the bearings when initially filling a hub. When properly filled, the fluid level will lie between the fluid level line and 1/4" above the line. (Note: Remember to replace vent plug when done.)

Grease-Lubricated Hubs

Repack the hub bearing with clean wheel bearing grease after disassembling, cleaning, and inspecting.

Universal Joint Lubrication

Refer to the Spicer Universal Joints and Driveshafts service manual and lubrication specifications.

Steering Gear Lubrication



CAUTION: *When adding fluid, be sure to use fluid of the same type. While many fluids have the same description and intended purpose, they should not be mixed due to incompatible additives. If incompatible (insoluble) fluids are mixed in a power steering system, air bubbles can be produced at the interface of the two fluids. This can cause cavitation, which reduces the lubrication between moving parts in the gear. This could result in worn components. The mixture of two different fluids, although harmless to individual internal components, may initiate a chemical reaction that produces a new compound that will attack seals and other internal components. Do not mix different fluids.*

Replacement

1. Replace fluid per the chart below.
2. Bleed the system if necessary

Table 10 Fluid and Filter Replacement Schedule

Steering Gear	Fluid * @	Inspect [mi.(km)]	Replace [mi. (km)/ months]
TRW	ATF	Every 15,000 (24,000)	Every 240,000 (384,000)/24
Sheppard	ATF	Every 15,000 (24,000)	Every 240,000 (384,000)/24
*Extremely low temperatures may require lower viscosity fluids; consult your Peterbilt dealer for recommendations			
@See TRW or Sheppard Service Manuals for additional fluid listings			

Inspection

NOTE: Before removing reservoir cover, wipe outside of cover so that no dirt can fall into the reservoir.

1. Check the fluid level; add fluid if required.
2. Check fluid for contamination, discoloration, or burnt smell; correct source of such problems before replacing fluid & filter.

Servicing Specific Systems And Units

This section will help you keep your Peterbilt vehicle in good running condition. There are a number of checks you can do, and you may be able to do some of the service work yourself. But please: let your dealer's service department do any work you don't have the tools or skill to perform. Authorized service mechanics are trained in the proper technical and safety procedures to fix your Peterbilt vehicle right.



WARNING! *It is dangerous to work on a vehicle without the right know-how and proper tools. You could be killed or badly injured, and you could damage the vehicle. Do only work you know you are fully capable of doing, and for which you have the right tools.*

Brake Adjustment



WARNING! *To prevent uncontrolled vehicle movement and reduce risk of death or personal injury, park the vehicle on a hard level surface, apply the parking brake, and chock all wheels securely.*

To operate your vehicle safely and profitably, you need some understanding of its brake systems. For more on brakes, see the Index, under Brakes.

Brake adjustment and brake balance must be set carefully to (1) make the most efficient use of the forces available for braking and (2) allow equal stopping forces at all wheels.



CAUTION: *The air brake system of this vehicle was configured for ONE of the following operations: tractor or truck, and complies with the respective portions of FMVSS 121. A tractor shall not be operated or configured as a truck, nor shall a truck be operated or configured as a tractor, without significant modifications to the air brake system in order to retain compliance with FMVSS 121. Contact your Peterbilt dealer for instructions.*

Once a brake system is set to specifications, changing any one of its components or any combination of components may cause the system to not work as well. All parts have to work together to perform as they should. Any replacement components in your brake system should be exactly equal to the original components. Any changes from the original specifications can affect the whole sys-

tem. All of the following areas are interrelated and must conform to original specifications:

- Tire Size
- Drum brakes
 - A. Cam Radius
 - B. Wedge Angle
 - C. Drum Radius
 - D. Brake Linings
 - E. Brake Chambers
 - F. Slack Adjusters
- Disc Brakes
 - A. Disc Rotors



WARNING! A nonconforming part in your brake system could cause an accident involving death or personal injury. Sizes and types are so related to one another that a seemingly unimportant change in one may result in a change in how well your brakes work for you on the road. If parts don't work together properly, you could lose control of your vehicle. Be sure any replacement parts in your brake system conform exactly to original specifications.

All vehicle operators should check their brakes regularly. Always adjust your brakes when they are cool.



WARNING! Do not use brake linings with a thickness below the specified minimum. Such linings will have lining rivets exposed that can damage the brake drum and reduce brake efficiency, which could cause death, personal injury or system failure

Air System

- Build up air pressure in the system to the governor cut-out point.
- Stop the engine.
- Release the parking brakes (push in the yellow knob).
- Watch the rate of air pressure drop. The rate of drop should not be more than 2 psi (14 kPa) per minute.
- Now start the engine and build up the air pressure again.
- Stop the engine. Ensure that the parking brakes are still released (i.e., the yellow knob is pushed in).
- Fully apply the service brakes.

- Watch the rate of air pressure drop registered by the air gauge. The rate of drop should not be more than 3 psi (21 kPa) per minute.
- If you find excessive leakage, a leakage test should be made at the air line connections and at all air brake control units. To perform a leakage test, refer to the detailed instructions in the Peterbilt Maintenance Manual, or take your vehicle to an authorized Peterbilt dealer.

Air Disc Brakes

Have brake pads inspected by a qualified mechanic for wear at regular intervals according to the [“Preventive Maintenance Schedule” on page 143](#). In severe service or off-highway applications inspect the linings more frequently.

Regularly inspect for pad/rotor wear:

- Park on level ground and chock the wheels.
- Temporarily release the parking brakes.
- Compare the relative position of two notches; one located on the caliper and the other on the carrier. See the illustration below to determine if the brakes require a detailed inspection by a qualified mechanic.

- Have a qualified mechanic perform a detailed inspection if the notches are not found. The pads and rotors should be measured and compared against the manufacturer's specifications located in the brake manufacturer's service manual.

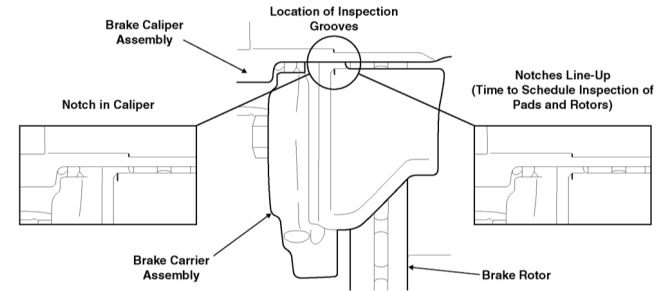

Regularly inspect caliper for Running Clearance:

- Stop the vehicle on level ground and let the brakes cool down. Hot brake calipers can burn skin on contact.
- Chock the wheels.
- Temporarily release the parking brakes.
- Grab the caliper and move it. This movement is Running Clearance.

- Proper Running Clearance is 0.08" (2 mm) of movement of the brake caliper (approximately the thickness of a nickel) in the inboard/outboard direction.
- Have a qualified mechanic provide further inspection if the caliper does not move or appears to move more than the specified clearance.

Drum Brakes

Have brake drum linings and disc brake pads inspected by a qualified mechanic for wear at regular intervals according to the maintenance schedule. In severe service or off-highway applications inspect the linings more frequently.

Automatic Slack Adjusters

Periodically check the Brake Chamber Stroke. Replace the slack adjuster if proper stroke cannot be maintained.

Operational checks of automatic slack adjusters

- Measure brake chamber stroke with the spring brake released and the air pressure no less than 100 psi (690 kPa).
- Brake Chamber Stroke is the difference between the applied and the retracted position of the air chamber pushrod.

- A correctly installed and functioning auto slack adjuster will produce the following strokes:

Chamber Type	Stroke
36 (rear brakes)	1 ¹ / ₂ " - 2 ¹ / ₄ " (38 - 57 mm)
30 (rear brakes)	1 ¹ / ₂ " - 2" (38 - 51 mm)
16, 20, & 24 (front brakes)	1" - 1 ³ / ₄ " (25.4 - 44.4 mm)

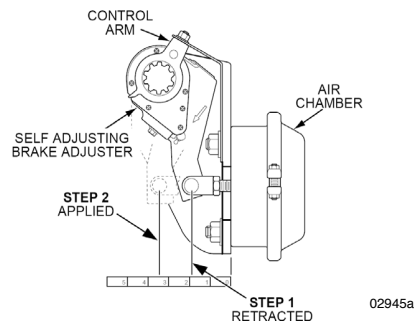

Brake Chamber Stroke



WARNING! *Manual adjustment of automatic slack adjusters is a dangerous practice that could result in an accident involving death or injury. It gives the operator a false sense of security about the effectiveness of the brakes. Contact the Service Department at your dealership if the stroke exceeds the above specifications. A stroke exceeding these values may indicate a problem with the slack adjuster or the brake foundation.*

Tires, Wheels, And Rims

Tires



WARNING! *Use only original equipment manufactured (OEM) components. Use of non-original equipment could cause wheel breakage and wheel separation from vehicle, which could result in an accident causing death or personal injury. Each mounting system is engineered only for use with its correct mating part. Be sure that properly matched components are used for each type of mounting. The comparison chart on [Page 184](#) illustrates the differences between*

parts used in hub-piloted mount and ball seat mount applications. Only OEM supplied hub-piloted or ball-seat mounted wheels may be used on this vehicle.

- *If you are not fully qualified and not equipped with the proper tools and equipment, do not attempt to raise the vehicle or remove or install the damaged tire and wheel assembly. Obtain expert help. A person can be killed or seriously injured and/or damage can result from using the wrong service methods. Truck tires and wheels should be serviced only by trained personnel using proper equipment. Do not reinflate a tire that has been run flat or is seriously low on air without first removing the tire from the rim and inspecting for damage.*
- *Follow OSHA regulations per section 1910.177.*
- *Follow all warnings and cautions contained within the tire and wheel manufacturers literature.*
- *Only properly trained personnel should service tire and rim assemblies.*

Your tires are a very important part of your vehicle's whole braking system. How fast you can stop depends on how much friction you get between the road and your tires. In

addition, keeping your tires in good condition is essential to the safe, efficient operation of your vehicle. Regular, frequent inspection and the right care will give you the assurance of safe and reliable tire operation. Here are some tips on maintaining your tires.

Checking Inflation Pressure

Give your tires a visual test every day, and check inflation with a gauge every week:

- When checking tire pressure, inspect each tire for damage to sidewalls, cuts, cracks, uneven wear, rocks between duals, etc. If a tire appears underinflated, check for damage to the wheel assembly. Don't forget to check between dual wheels. If you find wheel damage, have an expert tire service repair it.
- Maximum tire pressure will be indicated on the sidewall of a tire.
- Check pressure only when the tires are cool. Warm or hot tires cause pressure buildup and will give you an inaccurate reading. So never deflate a warm tire to the specified pressure.

- Lower tire pressure does not give you more traction on ice or snow. This is an old myth that refuses to die. Underinflation actually reduces traction, steering control and tire load capacity.

Underinflated Tires

Low pressure is a tire's worst enemy. Underinflation allows tires to flex improperly, causing high temperatures to build up. Heat causes early tire damage such as flex break, radial cracks, and ply separation. Low pressure may affect control of your vehicle, especially at the front wheels. Most tire wear problems are caused by underinflation as the result of slow leaks, so you'll want to check tire pressure regularly.



WARNING! Do not operate vehicle with underinflated tires. The extra heat caused by underinflation can cause sudden tire failure such as a tire fire or blow out which can cause an accident resulting in death or personal injury. Low pressure may affect control at the front wheels, which could result in an accident and serious injury. Keep your tires inflated to the manufacturer's recommended air pressure.

Overloaded tires

Overloading your truck is as damaging to your tires as underinflation. The following chart shows how neglect or deliberate abuse can affect the life of your tires.



WARNING! Do not exceed the load rating of your tires (molded on the side wall of your tire) or the maximum vehicle load rating, whichever is less. Overloading could result in premature tire failure causing you to lose control of your vehicle and result in an accident causing death or personal injury. The maximum vehicle load rating (GVWR) is found on the Tire and Rim Data label on the driver's door.

Vehicle Load	Normal	20% Over	40% Over	60% Over	80% Over	100% Over
Tire Pressure	Normal	20% Low	30% Low	35% Low	45% Low	55% Low
Expected Total Tire Mileage	Normal	70%	50%	40%	30%	25%

Overinflated tires

Too much air pressure reduces the tire tread contact area and results in rapid wear in the center of the tread.



WARNING! Overinflated tires can cause accidents. They wear more quickly than properly inflated tires and are more subject to punctures, cracks, and other damage. They could fail and cause you to lose control of your vehicle resulting in an accident causing death or personal injury. Be sure all tires are inflated correctly according to the manufacturer's recommendations.

The chart on [page 182](#) gives you the right load and inflation rates for different tire sizes. Please follow it for the safest and most economical use of your tires. (Consult the tire manufacturer for proper pressure settings with tires not listed in this table.)

Matching tires

Be sure to buy matched tires for your vehicle, especially on the rear axles. Mismatched tires can cause stress between axles and cause the temperature of your axle lubricant to get too hot. Matched tires will help your drive-line last longer and will give you better tire mileage.



WARNING! Do not mismatch wheel components. Equipment that does not exactly match original specifications or that is mismatched could cause the wheels to break and separate from the vehicle causing death or personal injury. Each mounting system is engineered for use only with its correct mating part. Be sure properly matched components are used for each type of mounting.

Replacing Tires



WARNING! Do not install regrooved or reinforcement-repaired tires on steering axles. They could fail unexpectedly and cause you to lose control of your vehicle resulting in an accident causing death or personal injury.

Front: Replace front tires when less than 4/32 in. of tread remains. Check at three places equally spaced around the tire.

Drive Axles or Trailers: Replace tires on drive axles or trailers when less than 2/32 in. of tread depth remains in any major groove. Check at three places equally spaced around the tire. See the next illustration for recommended measuring points for tread depth.



WARNING! Do not replace original equipment tires with load ratings less than the original tires. Doing so could lead to unintentional overloading of the tire, which could cause a failure resulting in loss of vehicle control and an accident causing death or personal injury.

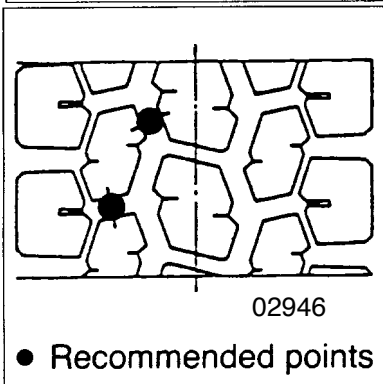
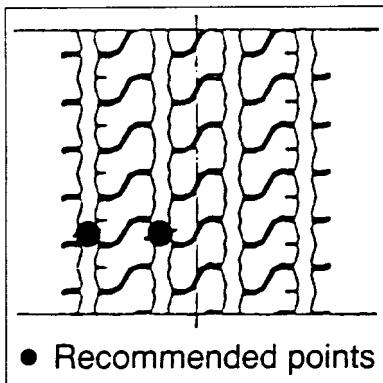

Steer Tire Points in Upper View, Drive Tire in Lower View



NOTE: To prolong your tires' life and make them safer, have their radial and lateral run-out checked at your dealer. And of course you should have your tires balanced any time you change a tire.

Tire chains

If you need tire chains, install them on both sides of each driving axle.



CAUTION: Chains on the tires of only one tandem axle can damage the driveline U-joints and the interaxle differential. Your repairs could be costly & time-consuming.

Speed Restricted Tires



WARNING! This vehicle may be equipped with speed restricted tires. Check each tire's sidewall for maximum rated speed. Vehicle should not be operated at sustained speed in excess of maximum rated speed. Failure to comply with these speed restrictions could cause sudden tire failure which can result in death, personal injury or property damage.

Tire Load and Inflation Tables

Table 12 Load Range Letters and Corresponding Ply Rating

(G = 14 ply; H = 16 ply)

SINGLE RADIAL TIRES FOR VEHICLES IN HIGHWAY SERVICE

Tire Size	Load Range	Tire Load Limits At Various Cold Inflation Pressures (psi)										
		70	75	80	85	90	95	100	105	110	115	120
11R22.5	G	4530	4770	4990	5220	5510	5730	5950	6175			
11R22.5	H	4530	4770	4990	5220	5510	5730	5950	6175	6320	6465	6610
11R24.5	G	4820	5070	5310	5550	5840	6095	6350	6610			
11R24.5	H	4820	5070	5310	5550	5840	6095	6350	6610	6790	6970	7160
275 / 70R22.5	H		4850	5050	5250	5480	5705	5945	6195	6450	6720	7000
295 / 75R22.5	G	4500	4725	4940	5155	5370	5510	5780	5980	6175		
285 / 75R24.5	G	4545	4770	4940	5210	5420	5675	5835	6040	6175		

DUAL RADIAL TIRES FOR VEHICLES IN HIGHWAY SERVICE

11R22.5	G	4380	4580	4760	4950	5205	5415	5625	5840			
11R22.5	H	4380	4580	4760	4950	5205	5415	5625	5840	5895	5950	6005
11R24.5	G	4660	4870	5070	5260	5510	5675	5840	6005			
11R24.5	H	4660	4870	5070	5260	5510	5675	5840	6005	6205	6405	6610
275 / 70R22.5	H		4430	4610	4795	5005	5210	5430	5660	5890	6135	6395
295 / 75R22.5	G	4095	4300	4540	4690	4885	5070	5260	5440	5675		
285 / 75R24.5	G	4135	4340	4540	4740	4930	5205	5310	5495	5675		



NOTES:

- Pressure listed is the minimum for the load.
- All tire load figures are in pounds.
- Figures in **Bold face** indicate maximum recommended load.

Source: Bridgestone Tire 2/02

Vehicle Loading



WARNING! Do not exceed the specified load rating. Overloading can result in loss of vehicle control, death or personal injury, either by causing component failures or by affecting vehicle handling. Exceeding load ratings can also shorten the service life of the vehicle.

- **The components of your vehicle are designed to provide satisfactory service if the vehicle is not loaded in excess of either the gross vehicle weight rating (GVWR) or the maximum front and rear gross axle weight ratings (GAWRs). Axle weight ratings are listed on the driver's door edge. Supervise all loading to ensure that (1) the Gross Vehicle Weight Rating (GVWR) is not exceeded and (2) the load is distributed correctly so that the weight distribution is within the limits of the front and rear axle load ratings. Severe damage to your vehicle, difficult handling, or an accident could occur if your vehicle is not loaded properly.**

- **An unevenly distributed load or a load too heavy over one axle can affect the braking and handling of your vehicle and cause an accident. Even if your load is under the legal limits, be sure it is distributed evenly.**

GVW: GVW is the Gross Vehicle Weight. This is the TOTAL WEIGHT your vehicle is designed to carry. Never carry so heavy a load that you exceed the GVW rating of your Peterbilt vehicle.

Axle Weight: Your front and rear axles are rated according to the load they are designed to carry. You will find this number listed on the driver's door frame.

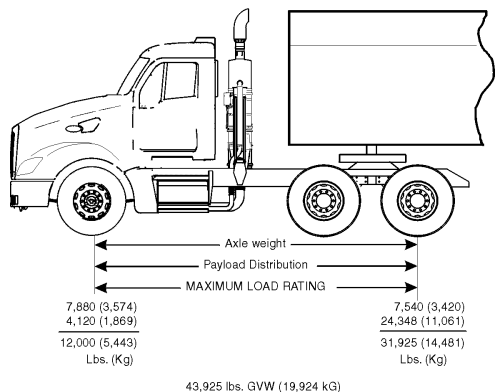

Load Distribution: Be sure any load you carry is distributed so that no axle has to support more than its load limit.

Wheels And Rims

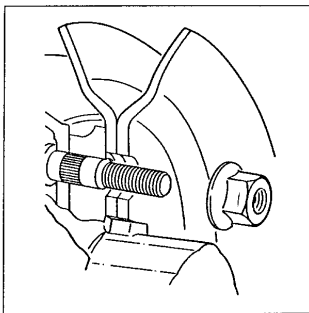

Hub Pilot Mount System

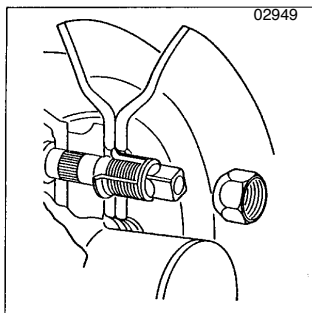

Ball Seat Mount System

Hub, Drum, and Stud Assembly

- **The hub pilot mounting system** uses M22x1.5 metric threads (about 7/8 in. dia.). The stud stands out at least 1.9 in. beyond the brake drum. All studs are right hand threads. Pilot bosses machined on the hub fit tightly to the wheel center bore.
- **The ball seat mounting system** uses 3/4 x 16 or 1-1/8 x 16 threads. The dual mounting studs provide 1.3 - 1.44 in. standout. Right hand and left hand threads are required. Inner and outer cap nuts center the wheels by seating against wheel ball seats.

Wheels

- **Pilot mount wheels** have stud holes that are reamed straight through (no ball seats). Center bore diameter is 8-21/32 in. Budd Uni-Mount - 10 wheels have UNI-MOUNT stamped on the disc.
- **Ball seat wheels** have spherical chamfers machined on each stud hole. Center bore diameter is 8-23/32 in.

Wheel Nuts

- **Hub pilot nut** has a hex body and a flange for clamping against wheel face. Hex size is 33 mm (same as 1-5/16 in.).
- **Inner and outer cap nuts** mate with spherical chamfers on wheels. Inner nut has 13/16 in. square end. Outer nut has 1-1/2 in. hex.



WARNING! Do not mismatch wheel components. Equipment that does not exactly match original specifications or that is mismatched could cause the wheels to break and separate from the vehicle causing death or personal injury. Each mounting system is engineered for use only with its correct mating part. Be sure properly matched components are used for each type of mounting.

Wheel Cap Nut Torque

At the first 100 miles, have all wheel cap nuts torqued to their specified value. After that, check wheel cap nuts at least once a week. Contact the Service Department at your dealership for information on the proper installation

procedure for the wheels on your truck. This is a job you may not be able to do yourself. You need the right torquing equipment to do it.



WARNING!

- **Never use oil or grease on studs or nuts; improper torque readings will result, which could cause improper wheel clamping and could lead to a wheel failure resulting in an accident causing death or personal injury.**
- **Tighten wheel cap nuts properly. If they are not tightened properly, wheel nuts could eventually cause the wheel to become loose, to fail, and/or to come off while the vehicle is moving, possibly causing loss of control if the vehicle and death, serious personal injury or damage to the vehicle.**

Wheel Bearing Adjustment

For safe, reliable operation and adequate service life, your wheel bearings must be checked and adjusted properly. The person best equipped to do this is your authorized dealer's service mechanic.

Disc Wheels

To check the torque on disc wheels, follow the crisscross sequence shown. See the Specifications chart for proper torque specification.



WARNING! Use the correct components and tools when working on wheels. Grooves in the wheel disc or other damage to the disc can weaken the wheel and cause it to eventually come off. This could cause you to lose control of your vehicle, and may result in an accident causing death or personal injury.

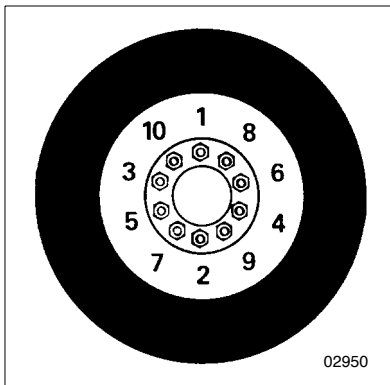

Crisscross Sequence For Disc Wheels

Demountable Rims

To check the torque on demountable rims, follow the crisscross sequence shown. See the Specifications chart for proper torque specification.



WARNING! Improperly mounting and demounting tire and rim assemblies is dangerous. Failure to observe proper precautions could cause the tire-rim assembly to burst explosively, causing serious injury or death. See the wheel manufacturer's literature for the proper way to mount and demount your tires and rims. Follow their precautions exactly.

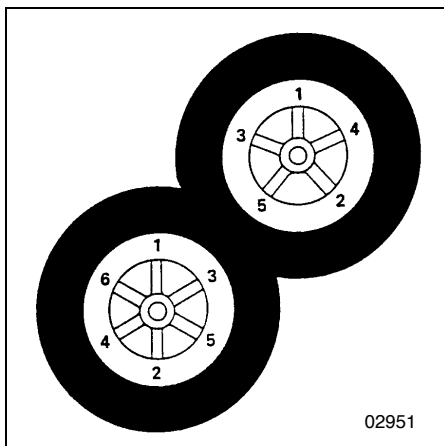

Crisscross Sequence For Demountable Rims

WHEEL AND NUT CONFIGURATION	STUD SIZE	TORQUES FOR INNER & OUTER CAP NUTS	
		Lb. Ft.	N.m
Stud-Piloted Disc Wheels	3/4"-16 Inner 1 1/8"-16 Outer	450-500	610-680
Heavy Duty Stud-Piloted Disc Wheels	15/16"-12 Inner 1 5/16"-12 Outer	750-900	1025-1225
PHP-10; Budd Uni-Mount-10; WHD-8	M22 x 1.5-6H	450-500	610-680
Cast Spoke Wheel Assembly	1/2" Dia. 5/8" Dia. 3/4" Dia.	Rim Clamp Nut Torque	
		80-90	110-120
		160-185	220-250
		225-245	305-335

Your Vehicle's Air System



WARNING! Prior to the removal of any air system component, always block and hold the vehicle by a secure means other than the vehicle's own brakes. Depleting air system pressure may cause vehicle to roll which may result in an accident involving death or personal injury. Keep hands away from chamber push rods and slack adjusters, they may apply as system pressure drops.

- After completing any repairs to the air system, always test for air leaks, and check the brakes for safe operation before putting the vehicle in service.
- Never connect or disconnect a hose or line containing air pressure. It may whip as air escapes. Never remove a component or pipe plug unless you are certain all system pressure has been depleted.
- Never exceed recommended air pressure and always wear safety glasses when working with air pressure. Never look into air jets or direct them at anyone.

- Never attempt to disassemble a component until you have read and understood recommended procedures. Some components contain powerful springs and injury can result if not properly disassembled. Use only proper tools and observe all precautions pertaining to use of those tools.
- Completely bypassing a Bendix AD-IS air dryer will bypass the system's pressure protection valves. This could lead to loss of air pressure or damage to the vehicle's air system, which could cause an accident or personal injury. Always adhere to the manufacturer's procedure if it is necessary in an emergency to temporarily bypass an AD-IS-series air dryer.

The operation of the vehicle's braking system and many vehicle accessories depends upon the storage and application of a high-pressure air supply.

Your vehicle's compressor takes outside air and compresses it, usually to 100-120 psi. The compressed air then goes to the reservoirs to be stored until needed. When you operate your air brakes, the stored compressed air flows into the chambers where it is used to apply your

truck and trailer brakes. That is why, when you push down on your brake pedal, you don't feel the same amount of pressure on the pedal that you do when you apply the brakes on your car. All you are doing on your truck is opening an air valve to allow air to flow into the brake chambers.

Air Supply System



WARNING! Do not operate the vehicle if leakage in the air system is detected. Conduct the following procedure and contact an authorized Peterbilt Dealer (or any other properly equipped service center) if a leak is detected. Failure to check the brakes or follow these procedures could cause a system failure, increasing the risk of an accident involving death or personal injury.

Contamination of the air supply system is the major cause of problems in air-operated components such as brake valves, wiper motors, and suspension height control valves. To keep contaminants to the lowest possible level, follow these maintenance procedures.



WARNING! If the supply and service tanks are not drained at the recommended frequency, water could be sent to all air lines and valves. This could cause corrosion, which could compromise the brake system safety and potentially cause an accident involving death or personal injury.

Daily

- Drain moisture from the supply and service air tanks.
- Operate air devices to circulate lubricants within the unit.

Periodically

- Clean filter screens ahead of the valves by removing the screens and soaking them in solvent. Blow them dry with pressurized air before reinstalling them.

Twice a Year

- Add approximately 1/4 oz. (7.5 ml) of light viscosity lubricant to the air line leading to the wiper motor. Acceptable lubricants are Dow Corning 200 fluid, 200 CS viscosity, and Sprague Wiper Lube. If you have alcohol dryers installed in the air system, the alcohol can wash away lubricants from the wiper motors.



CAUTION: *Don't use penetrating oil, brake fluid, or wax-based oils in the air system. These fluids may cause severe damage to air system components.*

- Maintain the air compressor to prevent excessive oil by-pass. See your shop manual for maintenance details.
- Replace worn seals in valves and air motors as they are needed.

Air Dryer



WARNING! *Use of incorrect air dryer could cause air system failure, leading to loss of vehicle control and serious personal injury or death. If your vehicle is equipped with a Bendix AD-IS air dryer, it is important that future replacements be identical or similar in design.*

Any deviation from the Bendix AD-IS type air dryer would require changes to the vehicle air system. Some vehicles use a dual air system consisting of a wet tank, forward dry tank, and rear dry tank. The dry tanks have a single-check valve in the tank inlet. The check valves prevent a complete loss of air in the event of an air system failure (tank or hose failure). This ensures a con-

trolled stop (with reduced braking capability). Other vehicles use a Bendix AD-IS air dryer which eliminates the need for a wet tank and check valves in the dry tanks.



NOTE: *A small amount of oil in the system may be normal and should not, by itself, be considered reason to replace a desiccant cartridge; oil-stained desiccant can function adequately.*

Every 900 operating hours or 30,000 miles/48,000 km or 3 months, check for moisture in the air brake system by opening reservoirs, drain valves, or valves and checking for the presence of water. A tablespoon of water in a reservoir would point to the need for a desiccant cartridge change. However, the following should be considered first:

- Air usage is exceptionally high/abnormal for a high-way vehicle. This may be due to accessory air demands or some other unusual air requirement that doesn't allow the compressor to load/unload in a normal fashion or it may be due to excessive leaks in the air system.
- When more than a 30-degree F (17-degree C) range of temperature occurs in one day, small amounts of water can accumulate in the air brake system due to condensation. Under these conditions, the presence

of small amounts of moisture is normal and should not be considered as an indication that the dryer is not performing properly.

- An outside air source may have been used to charge the air system, in which case this air did not pass through the drying bed.

Engine Cooling System

Your engine's cooling system is standard with Extended Life Coolant (ELC). ELC consists of a mixture of ethylene glycol, water, and organic acid technology chemical inhibitors. ELC prevents corrosion and scale formation as well as provides freezing and boiling point protection.



CAUTION: *The engine cooling system has very specific maintenance and inspection requirements. Failure to follow requirements can damage the engine. Engine damage can include but is not limited to:*

- Freezing
- Boiling
- Corrosion
- Pitted cylinder liners



This information is found in the engine manufacturers owner's manual. It is the owner's responsibility to follow all requirements listed in the engine manufacturers owner's manual.

What To Check In An ELC-filled Cooling System

ELC Concentration

Check the level of freeze/boilover protection, which is determined by the ELC concentration. Use a glycol refractometer to determine glycol level. Add ELC to obtain the ELC to water ratio required to provide the protection you need. Use the chart below to help determine how much ELC you need to add. In an ELC-filled cooling system, the freeze point should be maintained between -30° F and -45° F (-34° C and -43° C)



NOTE: *Maximum recommended ELC concentration is 60% ELC and 40% water by volume (a 60/40 coolant mixture). The minimum recommended concentration is 40%.*

Desired ELC/ Water ratio:	0%	10%	15%	20%	25%	30%	35%	40%	45%	50%	55%	60%	65%	70%	75%	80%	85%	90%	100%
Freeze point °F (°C)	+32 (0)	+25 (-4)	+20 (-7)	+15 (-9)	+10 (-12)	+5 (-15)	-5 (-21)	-12 (-24)	-23 (-31)	-34 (-37)	-50 (-46)	-65 (-54)	-75 (-59)	-84 (-64)	-70 (-57)	-55 (-48)	-43 (-42)	-30 (-34)	-5 (-21)

ELC Condition (Contamination and Inhibitor Concentration)

Perform a visual inspection of the ELC. It should have no cloudiness or floating debris. Determine the chemical inhibitor concentration level by using an ELC-specific test kit or test strips. Inhibitor concentration level determines corrosion protection. If you are concerned about possible coolant quality, contamination, or mechanical problems, submit a coolant sample for analysis. Improper maintenance may cause coolant degradation and could result in damage to the cooling system and engine components.

Consult your dealer or the ELC manufacturer's representative for recommended ELC test kits, test strips, and laboratory sample procedures.

ELC Extender

Add ELC extender if necessary at the maintenance interval under [“Cooling” on page 152](#).

Coolant Filter

If your vehicle came with a non-chemical filter (“blank filter”), replace it only with a blank filter at the interval specified in the [“Preventive Maintenance Schedule” on page 143](#). Never use filters that contain SCAs in an ELC-filled system.

Topping Off



WARNING! Removing the fill cap on a hot engine can cause scalding coolant to spray out and burn you badly. If the engine has been in operation within the previous 30 minutes, be very careful in removing the fill cap. Protect face, hands, and arms against escaping fluid and steam by covering the cap with a large, thick rag. Do not try to remove it until the surge tank cools down if you see any steam or coolant escaping. In any situation, remove the cap very slowly and carefully. Be ready to back off if any steam or coolant begins to escape.



NOTE: If frequent topping off is necessary and there are no visible signs of coolant leaks when the engine is cold, check for leaks with the engine operating at normal temperature.



WARNING! Handle coolant and antifreeze carefully. Ethylene glycol antifreeze is poisonous and can cause death or personal injury. Store in original fluid container only and always keep out of reach of children.

Check the coolant level after each trip. Add coolant as necessary. You may find your coolant level is not up to the correct level soon after you have filled the radiator. This may be because all the trapped air in the system has not yet been purged. It takes a little time for all the air to leave the system after you fill your radiator.

With the engine cold, top up with premixed coolant of the desired freeze protection concentration. Add coolant through the pressure cap neck of the surge tank.

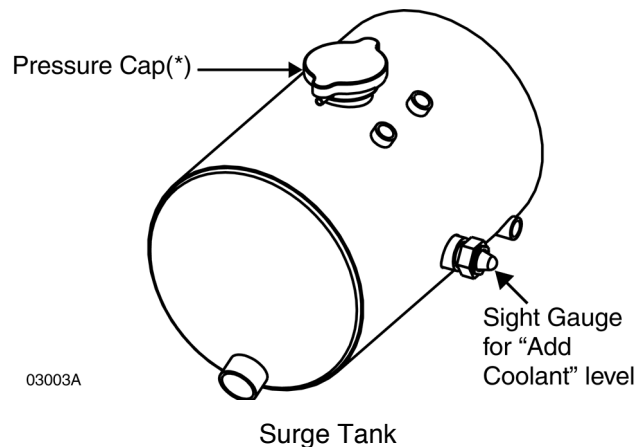

*Pressure Cap = 15 psi

Proper Coolant Level



NOTE: Do not overfill a cooling system. Excess coolant may result in overflow, loss of antifreeze, and reduced corrosion protection.

- The proper coolant level for a cold engine is at the base of the filler neck extension tube.
- The proper coolant level for an engine at normal operating temperature is even with the pressure cap seal.

Refilling Your Radiator

1. If your cooling system is built with petcocks in the upper engine coolant pipe, open them before filling the surge tank.
2. Be sure the radiator and engine block drains are closed.
3. Remove the surge tank pressure cap
4. Through the surge tank, fill the system with premixed coolant. Pour it in a steady flow until the surge tank is full. It may be necessary to pause for 1 minute and then re-fill if the fluid level dropped.



WARNING! Do not ingest ethylene glycol based antifreeze, it is poisonous. It can be harmful or fatal, especially to children. Store in its original container only and keep it out of reach of children.

5. If the system has petcocks, close them.
6. Start the engine and idle at a low RPM.
7. During low rpm idle, air will purge from the cooling system which will lower the coolant level in the surge tank. Continue to fill the surge tank until the level remains at the base of the fill neck. This may take up to 2 minutes.
8. Operate the engine throttle until the operating temperature stabilizes (when the thermostat opens).
9. Fill the surge tank as necessary to raise the coolant level to the proper reading.
10. Operate the engine at high idle for another 10 minutes and add coolant to raise the level back up to the base of the fill neck.
11. Replace the surge tank pressure cap.

Check the coolant level after each trip when the engine has cooled. Add coolant as necessary. You may find your coolant level is not up to the correct level soon after you have filled the radiator. This may be because all the trapped air in the system has not yet been purged. It takes a little time for all the air to leave the system after you fill your radiator.

Electrical



CAUTION: Do not modify or improperly repair the vehicle's electrical system or power distribution box. All electrical repairs should be performed by a qualified service technician. Improper repair or modifications will void your warranty and/or cause serious damage to your vehicle.

Battery Care

Regular attention to the charging system will help prolong the service life of your batteries. Here are some common causes of battery failure:

- **Overcharge:** This condition may result from improper voltage regulator adjustment. It results in overheating of the battery, warped plates, and evaporation of electrolyte.
- **Undercharge:** Your voltage regulator may be malfunctioning or is improperly adjusted, the drive belt is slipping, or your vehicle has undergone long periods of standing idle or short distance driving. These conditions result in battery plates becoming covered with a hard coating.
- **Vibration:** Loose battery hold-downs may cause battery plate failure.
- **Short Circuits:** These discharge a battery by draining electricity.
- **Dirty or Loose Connections:** Bad connections may stop the flow of electrical power to and from the battery.

Recharging Batteries

Except for using small trickle chargers to maintain battery condition, you should have your vehicle's batteries charged by a qualified service facility. To help reduce the risk of personal injuries, follow these guidelines carefully when recharging a battery:



WARNING! Batteries can kill or injure you severely. They contain acid, produce poisonous and explosive gases, and supply levels of electric current high enough to cause burns. A spark or flame near a battery on charge may cause it to explode with great force.

- Allow no sparks or open flame anywhere near the charging area.
- Charge a battery only in a well-ventilated area, such as outdoors or in a fully open garage which contains no pilot lights or other flames.
- Always make sure the battery charger is OFF before connecting or disconnecting the cable clamps.



WARNING! Always shield your eyes, your skin and painted surfaces to from contact with battery fluid. Batteries contain a corrosive fluid which can cause death or severe personal injury.

- Use protective eyewear.



CAUTION: Never use a metallic funnel to add distilled water. It could come in contact with a terminal, creating a short circuit, resulting in severe injury or damage to your vehicle.

- Maintain the full level of electrolyte in the batteries. This reduces the volume of gas in the cells. The electrolyte level should always be between 0.4–0.6 in. (10–15mm) above plates. **Fill with distilled water only.** After distilled water has been added, wait at least a half hour to measure solution density (specific gravity). The specific gravity should be between 1.258–1.265 or the electrolyte level within “MIN” and “MAX” marks.

- Before attempting any work on the batteries or electrical system, remove all jewelry. If metal jewelry or other metal comes in contact with electrical circuits, a short circuit may occur causing you to be injured—plus electrical system failure and damage.
- To avoid short circuits and damage to yourself or the vehicle, never place metal tools or jumper cables on the battery or nearby. Metal that accidentally comes in contact with the positive battery terminal or any other metal on the vehicle (that is in contact with the positive terminal), could cause a short circuit or an explosion.
- Keep all batteries away from children.



WARNING! Charger cables must be connected positive to positive (+ to +) and negative to negative (- to -). If connected improperly, batteries could explode causing death or serious personal injury.

- **Always make sure the battery charger is OFF before connecting or disconnecting the cable clamps. To reduce the danger of explosions and resulting death or serious**

personal injury, do not connect or disconnect charger cables while the charger is operating.

- Never reverse battery polarity.
- Battery terminals should not be coated with improper grease. Use petroleum jelly or commercially available, noncorrosive, nonconducting terminal coatings.
- Keep the battery clean and dry.
- Look for any signs of damage.



WARNING! Examine the battery and alternator cables for signs of damage or chaffing. A chaffed or damaged cable, in which wiring is exposed, can arch against metal components and cause a fire which can lead to death, personal injury or damage to equipment.

- Battery acid that may spill during charging should be washed off with a solution of warm water and baking soda to neutralize the acid. If you accidentally get acid in your eyes or on your skin, immediately rinse with cold water for several minutes and call a doctor.

- Do not charge a frozen battery; allow it to thaw out first. And always allow the battery to thaw gradually—do not apply direct heat. Gas trapped in the ice may cause an explosion.
- Never attempt to place the vehicle in motion, or run the engine with batteries disconnected.
- When fast charging, remove the battery caps so pressure doesn't accumulate.
- Never use a fast charger as a booster to start the engine. This can seriously damage sensitive electronic components such as relays, radio, etc., as well as the battery charger. Fast charging a battery is dangerous and should only be attempted by a competent mechanic with the proper equipment.

Slow Battery Charging



NOTE: Follow the instructions that come with your battery charger. It is not necessary to remove the battery from the compartment.

1. Make sure the electrolyte level in each cell is between the “MIN” and “MAX” marks. If the fluid level is below the “MIN” mark, correct the condition.

2. Disconnect the battery cables.
3. Connect charger cables.
4. Start charging the battery at a rate not over 6 amperes. Normally, a battery should be charged at no more than 10 percent of its rated capacity.
5. After charging, turn OFF charger and disconnect charger cables.

Jump Starting Batteries

If your battery is discharged (dead), you may be able to start it by using energy from a good battery in another vehicle. This is termed “jump starting.” Because of the various battery installations in optional electrical systems, Peterbilt does not recommend that you attempt to jump start your vehicle. If you have a battery problem, contact a Peterbilt Dealer or a reputable towing service. But if you are unable to do this, and must jump-start your vehicle, then ensure that you follow the precautions and instructions below.



WARNING! Batteries contain acid that can burn and gasses that can explode. Ignoring safety procedures can possibly cause death or severe personal injury.

- **Never jump start a battery near fire, flames, or electrical sparks. Batteries generate explosive gases. Keep sparks, flame, and lighted cigarettes away from batteries.**
- **Do not allow battery fluid to contact eyes, skin, fabrics, or painted surfaces. Always wear eye protection. Battery acid that may spill during charging should be washed off with a solution of warm water and baking soda to neutralize the acid. If you accidentally get acid in your eyes or on your skin, immediately rinse with cold water for several minutes and call a doctor.**
- **Be careful that metal tools or any metal in contact with the positive terminal do not contact the positive battery terminal and any other metal on the vehicle at the same time. Remove metal jewelry; avoid leaning over a battery. If metal jewelry or other metal comes in contact with electrical cir-**

cuits, a short circuit may occur causing you to be killed or injured—plus electrical system failure and damage to the vehicle.

- **Do not try to jump start or charge a frozen battery. (Even a battery with ice particles on the electrolyte surface is dangerous.) Allow it to thaw out first. And always allow battery to thaw gradually—do not apply direct heat. Gas trapped in the ice may cause an explosion.**
- **Do not try to jump start a vehicle if the electrolyte level in the battery of either vehicle is low. Maintain the full level of electrolyte in the batteries. This reduces the volume of gas in the cells.**
- **The voltage of the booster battery must have a 12-volt rating. And the capacity of the booster battery should not be lower than that of the discharged battery. Use of batteries of different voltage or substantially different capacity rating may cause an explosion. To avoid serious personal injury and damage to the vehicle, heed all warnings and instructions of the jumper cable**

manufacturer. The jumper cables must be long enough so that the vehicles do not touch.

- ***Applying a higher voltage booster battery will cause expensive damage to sensitive electronic components, such as relays, and the radio. Improper hook-up of jumper cables or not following these procedures can cause death, personal injury or damage to equipment.***
- ***Battery posts, terminals, and related accessories contain lead and lead compounds, chemicals known to the State of California to cause cancer and reproductive harm. Wash hands after handling.***
- ***To avoid serious personal injury and damage to the vehicle, heed all warnings and instructions of the jumper cable manufacturer.***



CAUTION: Departures from these procedures could also cause serious damage to both vehicles. Improper use of a booster battery to start a vehicle may cause an explosion.

To Jump Start Your Vehicle:

1. Wear eye protection and remove rings, metal watch bands, and any other metal jewelry.
2. Set the parking brakes. Place the transmissions of both vehicles in Neutral. Do not let the vehicles touch one another. Turn the ignition key to Off in the vehicle with the discharged battery. Also turn off lights, heater, and any other unnecessary electrical load.
3. If either battery has vent caps, remove them and check the fluid level. If it is OK, replace the caps before going further. If the level is low, add distilled water, and replace the caps before proceeding. If no water is available, remove the caps and cover the filler openings with a cloth before proceeding. After jump starting the vehicle, dispose of the cloth.



WARNING! If you do not cover the filler openings on the battery, electrolyte could boil out of the openings and cause death, serious injury or equipment damage. Replace caps securely if there is enough fluid in the battery, or cover with a cloth if no water is available and your fluid is low.

4. Attach one end of a jumper cable to the dead battery's positive terminal. This will have a large red "+" or "P" on the battery case, post, or clamp. Attach the other end of the same cable to the positive terminal of the good battery.
5. Attach the remaining jumper cable FIRST to the negative battery terminal (black "-" or "N") of the good battery, and then to the chassis or ground of the vehicle being jump started.
6. Start the engine in the vehicle with the good battery. Let it run a few minutes. Then start the engine in the vehicle with the dead battery. If the engine fails to start, do not continue to crank the starter but contact the nearest Authorized Service Center.



WARNING! When disconnecting jumper cables, make sure they do not get caught in any moving parts in the engine compartment. Failure to comply may result in death or personal injury.

7. Reverse the above sequence exactly when removing the jumper cables. Take care that your first step is to remove the cable from the chassis or ground of the vehicle that was jump-started.

Removing and Installing Batteries



WARNING! Always reinstall the battery compartment cover (step) before entering the cab. Without the battery cover you could slip and fall, resulting in death or personal injury.

Whenever you have to install a battery or remove one, follow these guidelines for the safety of yourself and the battery.

- Ensure all switches on the vehicle are turned Off.
- Disconnect the ground cable first when removing a battery.
- Connect the ground cable last when installing a battery.

Headlamp Adjustment

Follow the procedure below to adjust a headlamp. Vertical adjustment is controlled via an access hole on the backside of the headlamp assembly and a 10mm socket. Access to this adjuster knob is gained from inside the fender well. The headlights have vertical adjustment only.

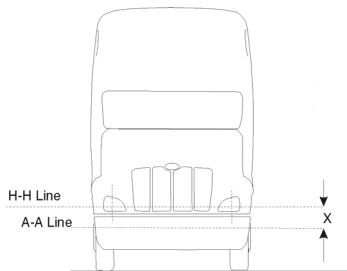
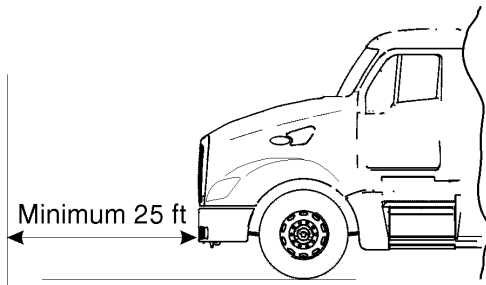

ADJUST AIM ZONE

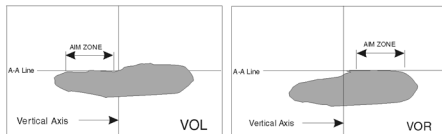

Beam pattern and aim zone
(from inside of cab looking at flat wall)

1. Ensure that the hood is properly adjusted.
2. Ensure that the hood is closed and completely latched.
3. Ensure that the tires are inflated to an on-highway setting.
4. Ensure that the headlamp surfaces are clean and dry.
5. Park the vehicle on a flat, level surface at least 25 ft from a suitable aiming surface.
6. Establish a horizontal line, no more than 1 in. (2.5 cm) wide, on a suitable aiming surface at the same height above a level surface as the optical center of the headlamp. The optical center is identified on the cover lens by a small dot. If a dot is not present, the optical center is the center of the beam that is being aimed.
7. Determine the headlamp identifier from the cover lens of the headlamp. Look for either the letters 'VOL' or 'VOR'.
8. Determine the H-H line value from the table below.

H-H Line	X	X
Distance from floor (mm)	VOR (mm)	VOL(mm)
560-900	0	53
900-1200	50	103
1200-1372	64	117

9. Establish a second horizontal line, no more than 1 in. (2.5 cm) wide, below the H-H line. This is the A-A line.
10. Using a 10 mm socket, turn the headlamp's adjuster until the aim zone visible in the beam pattern is level with the A-A line on the aiming surface; the lamp is now properly adjusted.
11. Repeat for opposite headlamp.

Low beams and high beams are integrated; only low beams need adjustment. The high beams should be level with the H-H line once the low beams are adjusted the the A-A line.

Transmission And Drive Train

Clutch Adjustment

Clutch pedal free travel is usually 1 3/4 in. to 2 in. (34 to 51 mm). This should be your guide for determining whether your truck needs clutch adjustment. Some vehicles have automatic clutch adjustment. If yours doesn't have this feature, adjustment will have to be done by a trained certified mechanic. Have the adjustment done before clutch pedal free travel is reduced to the minimum allowable 1/2 in. (13 mm).

Fuel System

Location of Fuel Shut-off Valves

Fuel shut-off valves for the fuel crossover line are on the bottom of the secondary fuel tank, at the crossover line connection. They are optional on the primary fuel tank.

Specification

Use only diesel fuel as recommended by engine manufacturers.



WARNING! A mixture of gasoline or alcohol with diesel fuel in the presence of an ignition source (such as a cigarette) could cause an explosion. You could be killed or seriously injured. Use only the recommended diesel fuel.



CAUTION: If anyone ever pours gasoline into your fuel tank, drain the entire system. Otherwise, the pump and engine will be damaged. Don't try to dilute the gasoline by adding diesel fuel (See Warning above).



CAUTION: Use Ultra Low Sulfur Diesel fuel only. Failure to do so may damage the engine and components of the Diesel Particulate Filter (DPF).

Fuel Filters

Please follow these recommendations when you are changing your fuel filters or strainer elements. Your engine will run better and last longer if you do. See the engine manufacturer's recommendations for proper water and micron requirements.



CAUTION: When removing filters, cover any electrical equipment and wiring that might get soaked with fuel. Diesel fuel may permanently damage electrical insulation.

- When installing spin-on (throwaway) filters, hand tighten them only to 1/2 to 2/3 turn after gasket contact. Mechanical tightening of these filters may distort or crack the filter head.



NOTE: To expel air from density-type strainer elements, soak them in clean fuel before installing them.

- When replacing a fuel filter element, don't use a substitute. Install only filter elements designed for fuel filtration. First clean and inspect the shell. Then insert the new element and fill the container at least 2/3 full of clean fuel before installing the shell.
- Throw away old gaskets. Replace them with new ones to ensure a positive seal.
- Position the shell and gasket properly. Then tighten the cover nut or bolt just enough to prevent fuel leakage.



CAUTION: Do not overtighten the valve. Overtightening can damage the threads.

- After starting the engine, check for leaks around the filter.

Emission Components

Deisel Exhaust Fluid Tank

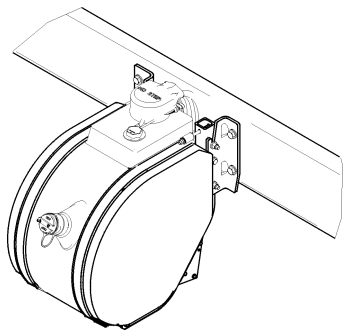

Vehicles that comply with 2010 EPA emission requirements will have a Deisel Exhaust Fluid (DEF) tank mounted to the vehicle frame. During normal operating situations, your vehicle may consume DEF at a rate of 3% per gallon of diesel consumed. The DEF tank has been designed to hold a minimum of 6% of the diesel fuel your vehicle is designed to carry.

DEF filter

The DEF system has a supply pump filter and this filter should be serviced according to the preventive maintenance schedule. Follow these steps to replace the DEF supply pump filter:

1. Turn off the vehicle and allow the vehicle to cool down. Take special precaution with hot exhaust piping.



WARNING! The exhaust piping can become extremely hot during engine operation and can cause personal injury including serious burns to the skin. Allow adequate cooling time before working near any part of the exhaust system.

2. Remove the pump protective plate mounted on the bottom of the DEF tank.

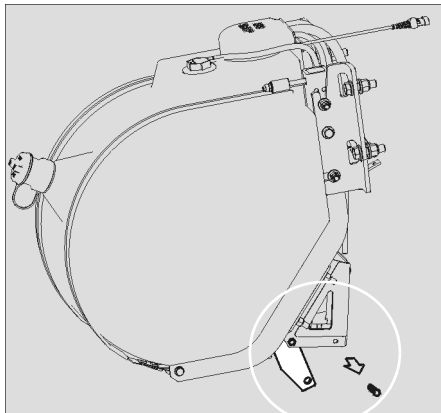

3. Using a 27 mm socket wrench (DIN3124), remove the filter cap that is screwed to the DEF Supply pump.

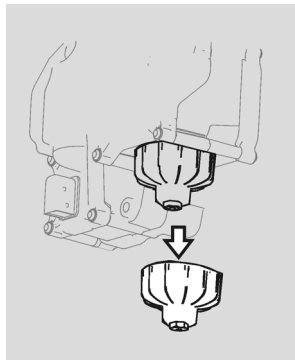

4. Replace filter and reassemble the cap. Tighten the cap to 11.4 - 18.5 lb-ft (15 - 25 Nm).
5. Replace the pump protective plate.

Steering

Guidelines For Checking A Steering System



WARNING! A steering system that is not working properly can cause an accident involving death or personal injury. You could lose control of your vehicle if the steering is not in good order. For driving safety, give your steering gear and components the following visual checks frequently. Check them especially after trips over rough roads.

- Check tie rod for straightness
- Check draglink clamp for looseness or interference
- Check ball joints and steering U-joints for looseness
- Check steering wheel for excessive freeplay. Check the simplest probable causes first:
 - Unequal tire pressures
 - Loose cap nuts
 - Bent tie rod
 - Loose wheel bearing

If these checks do not reveal the problem, or if you correct them and still have a steering problem, take your vehicle to an authorized dealer for evaluation.

Front End Alignment

For driving safety and comfort, and to prolong the life of your vehicle, it is important to have proper front end alignment. Check tire wear frequently. Uneven tire wear is a sign that your front end or rear axles may be misaligned.

If you see uneven wear, take your vehicle to a service center familiar with aligning front ends on Peterbilt vehicles.

Rear Axle Alignment

Continual road shock and load stresses may force your rear axles out of alignment. If you detect rapid tire wear on the rear axles, you may have misaligned axles. If you suspect you do, have your rear axle alignment checked and adjusted by an authorized dealership.

U-Bolt Tension for Front and Rear Axles

It is important that U-bolts remain tight. Off-highway use of your vehicle will cause them to loosen faster. But all vehicles need to have their U-bolts checked and tightened

regularly. Be sure someone with the proper training and the right tools checks and tightens the U-bolts on your Peterbilt. The proper torque requirements are specified in the Peterbilt Maintenance Manual for your vehicle.



WARNING! Do not operate the vehicle if the U-bolts are not properly tightened. Loose U-bolts do not properly secure the axle to the suspension. This could cause loss of vehicle control and an accident resulting in death or injury. Loose U-bolts can also cause uneven tire wear and poor alignment.



WARNING! Failure to maintain the specified torque values or to replace worn parts can cause component system failure, possibly resulting in an accident causing death or injury. Improperly tightened (loose) suspension U-bolts can lead to unsafe vehicle conditions, including: hard steering, axle misalignment, spring breakage or abnormal tire wear. See the Fastener Torque Tables for proper torque specifications.



WARNING! Do not replace U-bolts and nuts with common U-bolts or standard nuts. These parts are critical to vehicle safety. If the wrong U-bolts or nuts are used, the axle could loosen or separate from the vehicle and cause an accident involving death or personal injury. Use only U-bolts and nuts of SAE Grade 8 specification or better.

Fasteners

Frame Fastener Torque Specifications

Table 14 Frame Fastener Torque Specifications

Fastener Type	Fastener Size	Torque	
		Lb. ft.	N.m.
Bolt / Locknut / Hardened Washer	1/2 Inch	86 - 108	117 - 147
	5/8 Inch	130 - 163	176 - 221
	M12	65 - 85	89 - 115
	M16	155 - 195	210 - 264
	M20	315 - 385	427 - 523



CAUTION: When installing bolts on the frame, use only metric grade 10.9 bolts of the proper length.

Standard Capscrew Torque Specifications

Table 15 Capscrew Torque Specifications

SAE Grade Number	5		8	
	Torque		Torque	
	Lb. ft.	N.m.	Lb. ft.	N.m.
1/4-20	6 - 9	8 - 12	9 - 12	12 - 16
-28	7 - 10	9.5 - 14	10 - 14	14 - 19
5/16-18	13 - 18	18 - 24	18 - 25	24 - 34
-24	14 - 20	19 - 27	20 - 28	27 - 38
3/8-16	22 - 32	30 - 43	31 - 44	42 - 60
-24	25 - 40	34 - 54	35 - 50	47 - 68
7/16-14	35 - 50	47 - 68	50 - 71	68 - 96
-20	39 - 56	53 - 76	56 - 80	76 - 108
1/2-13	54 - 77	73 - 104	76 - 109	103 - 149

Table 15 Capscrew Torque Specifications (Continued)

SAE Grade Number	5		8	
-20	58 - 87	79 - 118	86 - 123	117 - 167
9/16-12	78 - 111	105 - 151	110 - 158	149 - 214
-18	87 - 124	118 - 168	123 - 176	167 - 239
5/8-11	108 - 154	147 - 209	153 - 218	208 - 296
-18	122 - 174	166 - 236	173 - 247	235 - 335
3/4-10	192 - 273	260 - 370	271 - 386	367 - 523
-16	214 - 305	290 - 414	303 - 431	411 - 583
7/8-9	309 - 441	419 - 598	437 - 624	593 - 846
-14	341 - 486	462 - 659	482 - 589	654 - 799
1 - 8	464 - 662	629 - 898	656 - 935	889 - 1268
1-12	508 - 724	689 - 982	718 - 1023	973 - 1386

The torque values in the previous tables are based on the use of clean and dry threads.

Frame Fasteners

- Go around your vehicle as per the [Preventive Maintenance Schedule](#) and tighten all frame fasteners with a torque wrench.
- Always use the torque values listed in frame fastener table.
- Always torque fasteners from the nut end.

For standard capscrews

- Always use the torque values listed the capscrew table.
- Reduce torque by 10% when engine oil is used as a lubricant.
- Reduce torque by 20% if new plated capscrews are used.

Engine Accessories

Accessory Drive Belts

You can extend the reliability and service life of your vehicle's drive belts with proper attention to installation, adjustment, and maintenance. Neglect could cause belt

failure. The result could be the loss of the electrical or air system as well as possible engine damage from overheating. So it's a very good idea to check your belts frequently and replace them as soon as you detect trouble.

Follow this procedure to install an accessory drive belt:

1. Route the new belt around the pulleys, and then rotate the automatic tensioner so that the idler pulley swings toward the belt routing. Refer to figure below an example of the rotation direction to release the tensioner.

Belt route for PACCAR MX Engine

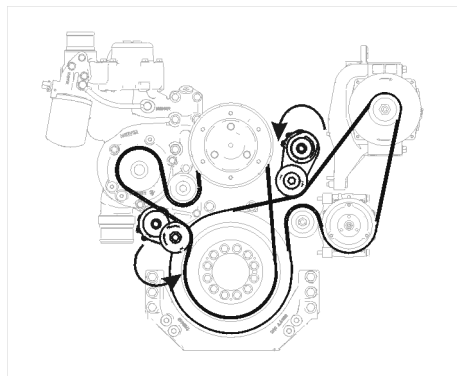

Belt route for Caterpillar Engine

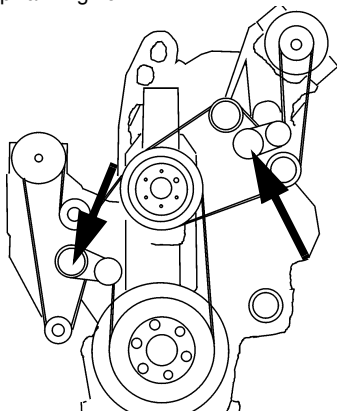

2. Slip the belt around the idler pulley attached to the automatic tensioner.
3. Release the automatic tensioner.
4. Check the belt alignment on each pulley. The belt must fall between the flanges of each pulley.

Fan Clutch / Fan



WARNING! Do not work on the fan with the engine running. The engine fan can engage at any time without warning. Anyone near the fan when it turns on could be killed or seriously injured. Before turning on the ignition, be sure that no one is near the fan.

Your truck may be equipped with an On/Off or Viscous Fan Drive. Follow these guidelines to check your engine fan:

- Check the fan assembly mounting bolts for tightness. Inspect the fan blades for damage.

On/Off Fan Drives - Check the clutch operation by starting the engine when it is cold. Idle the engine at about 800 RPM. Listen for air leaks. Check that the fan is not working while the engine is warming up. When the clutch engages, note the reading on the vehicle's panel-mounted coolant temperature gauge. If the fan clutch engages at low engine temperature or cycles on and off more frequently than it should (receives "false signals"), have the problem corrected at your dealership.

Air Intake System

Engine heat, vibration, and age combine to loosen air intake connections and cause cracks in the tubing and elbows. Leaks in the intake system allow abrasive dust to enter the engine and quickly cause expensive damage. During your daily walk-around inspection, carefully check all tubing, elbows, clamps, supports, and fasteners for condition and tightness.



CAUTION: Improper maintenance of the air intake system will allow abrasive dust to enter the engine which can cause equipment damage.

Under normal operating conditions, we recommend complete disassembly and cleaning of the air intake system annually.

Under severe operating conditions, such as heavy off-highway use, the disassembly and cleaning should be more frequent. Replace any defective parts. With the possible exception of mounting brackets, don't repair defective parts.

Air Cleaners

The following service information is basic to all air cleaner makes and models.

Service the air cleaner filter elements as specified in the Preventive Maintenance Schedule. If your vehicle is equipped with an optional air inlet restriction indicator, service the filter elements when the air inlet restriction indicator locks in the extreme Up position. Paper elements require care and proper handling because they are critical to engine service life.

Turbocharger

When servicing the air intake and exhaust systems on a turbocharged engine, check the items that follow. If you detect any deficiencies, take the vehicle to an authorized dealer for servicing. Delay could lead to severe and expensive damage to your vehicle.



WARNING! The exhaust piping and Diesel Particulate Filter can become extremely hot during engine operation and can cause death or personal injury. Allow adequate cooling time before working on or near any part of the exhaust system.



WARNING! *If your vehicle becomes disabled, the hot exhaust system could ignite dry grass, brush, spilled fuel, or other material that can cause fires which can lead to death, personal injury and property damage. Do not park or operate your vehicle in areas where the hot exhaust system could cause a fire.*



CAUTION: *This truck is equipped with a diesel particulate filter in order to meet both noise and exhaust emissions requirements. Removal or tampering with the unit will not improve engine performance. Also tampering is against the rules that are established by the U.S. Code of Federal Regulations. The unit may only be replaced with an approved part.*



WARNING! *Do not operate engine with the turbocharger intake piping disconnected. A suction is created when the engine is running. This suction could draw your hand or anything else near it into the impeller fan. You could be killed or seriously injured. Always keep the intake piping connected when you will be running the engine.*



CAUTION: *Operating the engine with the turbocharger intake piping disconnected will allow abrasive dust to enter the engine which can cause equipment damage.*

- Lubricating System: Check the oil lines, housing, and connections. Look for leaks, damage, or deterioration. Leaks could mean you have damaged oil lines or oil seals.
- Manifold: With the engine operating, check for leaking manifold or flange gaskets.
- High Frequency Vibration: Vibration may indicate turbo rotor imbalance. Have your dealer investigate this immediately.

Exhaust System

Details of inspection and maintenance of your exhaust system are covered under “Noise Control System” on page 222.

Anti-lock Braking System (ABS)

For details of use and maintenance of your anti-lock system, see the anti-lock braking system service literature that came with your truck.

Below are some general notes on repairing your anti-lock braking system:

- The foundation brake system must be in proper working order to ensure the best ABS performance.
- Before welding anywhere on the vehicle, detach the ABS ECU connector and all other electronic control units.
- Never detach the ECU connector with the ignition turned on.
- Do not attempt to repair ABS/ASR/ATC electrical cables that are outside the vehicle. Replace faulty cables as an assembly.
- When servicing brakes, hubs, or axle, recoat the ABS sensors with anti-seize compound. Make sure the sensor is pushed against the pulse wheel after the hub is reinstalled. On rear axles, the sensor should be pushed fully into the mounting block before reinstalling the hub.
- Check ABS wiring harnesses and piping periodically for chafing or other problems. No regular maintenance is required on the ABS components.

- During wheel balancing, dyno testing, or any time the ignition is on with part of the ABS disconnected, a failure code will be recorded. After servicing or testing of the vehicle is completed, clear the failure codes.

If, due to operating conditions, a brake application causes either wheel on the same axle to begin skidding, wheel speed sensors immediately signal the anti-lock controller in the modulator assembly. The controller responds instantly by signaling the solenoids in the modulator which activate the air valves, reducing application pressure as needed to prevent the wheels from locking up. If this overriding correction is effective, application pressure is allowed to build up to the original input.

Any malfunction of the anti-lock system on one or more axles will cause the system to fail-safe, and the panel-mounted amber warning light will come on, indicating both a malfunction, and automatic shut-down of the system. If the air system is intact (indicated by the pressure gauges), the service brakes will continue to function normally, but without benefit of the anti-lock feature.



WARNING! *Although the brakes will continue to operate with a malfunction in either circuit, the vehicle should not be operated until the system is repaired, and both braking circuits, including all pneumatic and mechanical components, are working properly. Failure to do so may result in death or personal injury.*



CAUTION: *Do not attempt to recycle the anti-lock system until the vehicle has been brought to a full stop.*



NOTE: *If one wheel on any driven axle continues to slip or spin for approximately 4 seconds, this will cause the anti-lock controller for that axle to go into the fail-safe mode, and the warning light will give a shutdown signal. In this case, the anti-lock system can be turned back on, and the warning light extinguished, by turning the key switch OFF and ON, after the vehicle has been brought to a full stop. When the key switch is turned back on, the warning light will illuminate and remain on for 3 to 5 seconds. This is a built-in function test of the warning light.*

Cab Heater-Air Conditioner

The combination heater-air conditioner provides comfort for those in the cab through accurate control of the cab environment in all weather conditions. Regular attention will help you keep your unit running well.



NOTES: *Keep the engine exhaust system and the vehicle's cab/sleeper ventilation system properly maintained. It is recommended that the vehicle's exhaust system and cab/sleeper be inspected*

- *by a competent technician every 15,000 miles*
- *whenever a change is noticed in the sound of the exhaust system*
- *whenever the exhaust system, underbody, cab or sleeper is damaged*



NOTES: Allow for the proper operation of the vehicle ventilation system:

- *Keep the inlet grille at the base of the windshield clear of snow, ice, leaves, and other obstructions at all times.*
- *Keep the exhaust pipe area clear to help reduce the buildup of exhaust gases under the vehicle.*

Perform the following checks every 3 months or 30,000 miles / 48,000 km, whichever occurs first:

Heater

- Check all heater controls for full-range operation.
- Check hoses, connections, and heater core for condition and leaks.
- Check the drain pan of the fresh air vent for trapped water before assuming that there is a leak in the heating system.
- If the heater core is leaking, take the vehicle to a Peterbilt dealer for proper heater service or repair.

- Check the heater core for debris blocking the air flow. If the blower is functioning properly, yet the heater is not operating properly, the heater core may be clogged. Clean the heater core if necessary. If the condition persists, take the vehicle to a Peterbilt dealer for proper heater service or repair.

Air Conditioner



WARNING! The air conditioning system is under pressure. If not handled properly, it could explode, causing death or injury to you and can damage your vehicle. Any servicing that requires depressurizing and recharging the air conditioning system must be conducted by a qualified technician with the right facilities to do the job.

- Check the compressor belt condition and proper tension. Adjust 105 - 125 pounds.
- Check the compressor and drive clutch for noise and vibration. If you find problems, have the system checked thoroughly. A malfunctioning clutch usually indicates trouble elsewhere in the system.

- Check the evaporator core and condenser core for debris restricting air flow. Clean if necessary. Small particles may be removed with compressed air blown through the core in the opposite direction of normal air flow.



WARNING! *Wear eye protection any time you blow compressed air. Small particles blown by compressed air could injure your eyes.*

- Check all hoses for kinks, deterioration, chafing, and leaks. Adjust kinked or chafing hoses to eliminate restrictions and prevent further wear.
- Check all components and connections for refrigerant leaks. If you discover a leak, don't try to tighten a connection. Tightening a connection may cause a worse leak. Have a qualified technician correct the problem.



NOTE: *A leaking evaporator or condenser core cannot be repaired; it must be replaced.*

- Have the air conditioning system fully inspected annually by your dealer.

Special Precautions



WARNING! *Excessive heat may cause your air conditioning system to explode which may result in death or personal injury. Never weld, solder, steam clean, or use a blow torch near any part of the air conditioning system. If a refrigerant leak develops in the presence of excessive heat or an open flame, hazardous gases may be generated. These gases may cause illness or death. If the system is leaking refrigerant*

- *Stay away from the hot engine until the exhaust manifold has cooled.*
- *Don't permit any open flame in the area. Even a match or a cigarette lighter may generate a hazardous quantity of phosgene gas.*
- *Don't smoke in the area. Inhaling gaseous refrigerant through a cigarette may cause illness.*

Appearance

Painted Surfaces



CAUTION: Do not aim the water jet directly at door locks or hatch. Tape the key holes to prevent water from seeping into the lock cylinders. Water in lock cylinders should be removed with compressed air. To prevent locks from freezing in the winter, squirt glycerin or lock deicer into the lock cylinders.

- Wash frequently to remove grime and caustic deposits that may stain the finish. Apply cool or lukewarm water. You may want to use a mild soap.
- Avoid washing your vehicle in bright sunlight.



WARNING! Handle cleaning agents carefully. Cleaning agents may be poisonous and cause death or personal injury if swallowed or inhaled. Keep them out of the reach of children.

- Road tar may be removed with a special commercial tar remover or mineral spirits.

- Waxing offers added protection against staining and oxidation. But to allow enough time for your truck's finish to cure, wait about ninety days after the date of manufacture before waxing. Don't wax in the hot sun. Don't friction burn the paint with a buffing machine.

Aluminum and Chrome Surfaces

- Clean aluminum wheels and bumpers with warm water.
- Tar remover will get rid of heavy deposits of road grime.
- To prevent spotting, wipe aluminum surfaces dry after washing.
- Under corrosive conditions, such as driving on salted roads, clean aluminum parts with steam or high pressure water from a hose. A mild soap solution will help. Rinse thoroughly.
- Chrome surfaces are best cleaned with fresh water. Wipe dry to preserve their luster. A commercial chrome cleaner will remove light rust. After cleaning, wax flat surfaces and apply a thin coat of rust preventive lubricant around bolts or other fasteners.

Stainless Steel

Follow this procedure to clean and restore the finish of stainless steel components:

1. In a plastic pail mix 4 tsp of alum (a powder found in grocery stores or drugstores), with 32 oz. of water (warm water will dissolve alum faster, but cool will work).
2. Apply the alum/water solution with a pad of steel wool (0000 grade or finer). GENTLY wipe the component lengthwise; no pressure is necessary.
3. It is the chemical reaction between the carbon steel of the wool and the alum solution that cleans the stainless, not the scrubbing or abrasive action of application.
4. You may also use any stainless cleaner recommended for cleaning boat parts.

Interior

Cleaning Cab Interiors

Peterbilt cab and sleeper interiors are built using a variety of different materials including fabrics, carpet, polyure-

thane, and painted plastic surfaces. These cleaning procedures will ensure that interior components remain in good condition for the life of the vehicle.

General Cleaning Guidelines



WARNING!

- ***Cleaning agents may contain hazardous agents. Thoroughly read, understand and follow the manufacturer's instructions when using a cleaning agent to avoid possible death, personal injury and property damage.***
- ***Handle cleaning agents carefully. Keep them out of the reach of children. Commercial cleaning agents may be poisonous.***



CAUTION: To avoid possible property damage

- ***Do not spray any kind of liquid directly at instruments or controls. Apply cleaner to a rag first and then clean instruments and gauges. Excess fluid may damage the use and function of instruments and gauges.***

- ***Always test a commercial cleaning agent on an inconspicuous area of the surface to be cleaned before using it.***
- ***Never clean interior components with chemicals or solvents such as***
 - Gasoline
 - Naphtha
 - Acetone
 - Turpentine
 - Benzene
 - Carbon Tetrachloride
 - Lacquer Thinner
 - Nail Polish Remover
 - Ammonia-based Products
 - Diesel Exhaust Fluid
- ***Clean difficult stains such as oil, grease, and mustard as soon as possible. The longer a stain goes untreated, the more difficult it is to remove.***
- ***Avoid application of conditioning products containing silicones or waxes to the top surface of the dash panel. This may cause glare that can be a driver distraction.***

Interior Trim, Dash Shell, and Instrument Panels



CAUTION: To avoid possible damage to these components, do not use abrasive cleaners, brushes, chemical solvents or strong detergents.

- Use a clean, lint-free cloth.
- Clean with the cloth dampened with a mild soap-and-water solution.
- Remove soap with a clean, damp rag.
- For difficult stains on painted plastic surfaces, such as the dash shell, use Dupont™ Sontara® cleaner, part number PS-3909S. The product is available from Dupont as a presaturated wipe.

Carpet



CAUTION: Do not apply water directly to carpet. Excess water may damage the carpet. Keep carpet as dry as possible.

- Use a clean, lint-free cloth or clean, soft-fiber brush.
- Clean with the cloth or brush dampened with a mild soap-and-water solution.

- Remove soap with a clean, damp rag.
- If a stronger cleaning solution is required, use a foam-type carpet shampoo.

Vinyl and Fabric Upholstery



CAUTION: To avoid possible damage to the upholstery, do not use chemical solvents or strong detergents on these components.

- Use a clean, lint-free cloth.
- Clean with the cloth dampened with a mild soap-and-water solution.
- Remove soap with a clean, damp rag.
- For difficult stains, use a commercial fabric or vinyl cleaner.

Leather Upholstery



CAUTION: To avoid possible damage to the upholstery, do not use oils, varnishes, solvents, abrasive cleaners or shoe polish on these components.

- Use a clean, lint-free cloth.

- Clean with the cloth dampened with lukewarm water.
- Dry with a clean cloth.
- For difficult stains, use a commercial leather cleaner.

Weatherstripping

Occasionally spray weatherstripping on doors and windows with silicone compound to help preserve resiliency. This is especially useful in freezing weather to prevent doors and windows from sticking shut with ice.

Chassis

Hose dirt and grime from the entire chassis. Then if an oil leak develops, you will be able to detect it easier.



CAUTION: Do not spray the suspension with chemical products or mineral oil; it can cause damage to the bushings.

Storing and Reintroducing Vehicles Into Service

To help maintain a vehicle in storage as well as ease its reintroduction into service, perform the following actions at least monthly:

- Wash and protect painted and metal surfaces, and also weatherstripping, as outlined in the preceding “Appearance” information.
- Operate the vehicle to circulate fluids and lubricants that have settled to the lowest part of a component. This will provide protection against corrosion on gears and bearings and keep seals resilient.

Before starting the engine, do the following:

- Check the engine oil level and fill as required.
- Check and maintain batteries as outlined on [page 195](#).
- Drain any condensation from the fuel/water separator, if so equipped.
- Start the engine and bring to normal operating temperature:
- Operate the air conditioning system at least 10 minutes.
- Drive the vehicle a short distance to allow lubricants to circulate in the transmission and axles.

Noise Control System Noise Emission Warranty

Peterbilt Motors Company warrants to the first person who purchases this vehicle for purposes other than resale and to each subsequent purchaser that this vehicle, as manufactured by Peterbilt Motors Company, was designed, built and equipped to conform at the time it left Peterbilt’s control with all applicable U.S. EPA Noise Control Regulations.

This warranty covers this vehicle as designed, built and equipped by Peterbilt, and is not limited to any particular part, component or system of the vehicle manufactured by Peterbilt. Defects in design, assembly or in any part, component or system of the vehicle as manufactured by Peterbilt, which at the time it left Peterbilt’s control caused noise emissions to exceed Federal standards, are covered by this warranty for the life of the vehicle.

Tampering with Noise Control System Prohibited

Federal law prohibits the following acts or the causing thereof:

(1) The removal or rendering inoperative by any person other than for maintenance, repair, or replacement, of any device or element of design incorporated into any new vehicle for the purpose of noise control prior to its sale or delivery to the ultimate purchaser or while it is in use, or (2) the operation of the vehicle after such device or element of design has been removed or rendered inoperative by any person.

Among those acts presumed to constitute tampering are

Engine Cooling System

- Removing or rendering inoperative the fan clutch.
- Removing the fan shroud.

Air Intake System

Removing or rendering inoperative the air cleaner / silencers or intake piping.

Exhaust System

- Removing or rendering inoperative the exhaust system components.
- Inner Fender Shields and Cab Skirts

- Removing shields or skirts.
- Cutting away parts of shields, skirts or damaged or loose portions of shields or skirts.

Fuel System

- Removing or rendering engine speed governor inoperative, allowing engine speed to exceed manufacturer's specifications.
- Removing air signal attenuator on engines equipped with this device.

Noise Insulating Blankets

- Removing noise insulators from engine block or from around the oil pan.
- Cutting holes in, or cutting away part of, noise insulators.
- Removing hood-mounted noise insulation.

Engine Electronic Control Unit (ECU)

Modifying ECU parameters.

Inspection & Maintenance Instructions for Noise Control System

The following instructions are based on regular inspection of the noise control system. If, during regular inspection or maintenance of other systems or components, you find something wrong with parts of the noise control system, inspect those parts more frequently to be sure they are performing up to specification. At the end of this section you will find the Maintenance Log. This is a schedule of inspection and maintenance intervals for each component.



WARNING! The exhaust piping and Diesel Particulate Filter can become extremely hot during engine operation and can cause death or personal injury. Allow adequate cooling time before working on or near any part of the exhaust system.

Exhaust System



WARNING! If your vehicle becomes disabled, the hot exhaust system could ignite dry grass, brush, spilled fuel, or other material that can cause fires which can lead to death, personal injury and property damage. Do not park or operate your vehicle in areas where the hot exhaust system could cause a fire.

Manifold

Check for exhaust leaks and condition of gaskets. Replace any blown gaskets. Use a torque wrench to check all cap-screws, including those at the flanges. Refer to the engine manufacturer's service manual for proper tightening sequence and torque values.

Joints and Clamps

Check for leaks, and tighten as necessary. Check for deterioration or dents in pipes and clamps which could allow exhaust to escape.

Piping

Check for rust, corrosion, and damage. If piping is performed at any point, temporary patching or lagging is acceptable until you can have permanent repairs made. On turbocharged engines check joints at the flanges and mounting brackets for tightness.

Diesel Particulate Filter (DPF)



NOTE: Use only exact replacement components in exhaust systems. Certain components contain integral catalytic converters essential for compliance with EPA emission standards. Using a non-compliant component as a replacement could violate these standards and also void the emission system's warranty.

Check clamps and mounting brackets for security. Check internal baffling for security. You can do this by listening for rattling sounds while tapping the unit with a rubber mallet or revving the engine up and down through its normal operating range. Check the DPF for rust and corrosion.

Exhaust Tail Pipe(s)

Check the mounting security. Tighten as necessary. The miter cut at the tip of the pipe must be facing the rear of the truck. Do not modify the end of the pipe in any way.

Fan Shroud



WARNING! Do not work on the fan with the engine running. The engine fan can engage at any time without warning. Anyone near the fan when it turns on could be killed or seriously injured. Before turning on the ignition, be sure that no one is near the fan.

Check all fasteners for tightness. Check for stress cracks in the shroud. Make sure the shroud is adjusted so that it does not touch the fan blades.

Hood Insulation Blanket

Fasteners

Check all fasteners for condition and security. Repair or replace any broken or defective fasteners.

Blanket

Check for chafing, tears, etc. Patch it if necessary. Find the cause of the damage. If any component or accessory is causing wear or damage and can't be relocated, put reinforcing pads on the blanket at the site of wear.

Engine Mounted Noise Insulators**Fasteners**

Check for condition and security. How you do this will depend on the method of attaching the noise insulators on the engine and around the oil pan (bolts, snap fasteners, or straps). Tighten loose fasteners; repair or replace any worn or damaged fasteners.

Insulators

Check insulators around fasteners and stress points, especially where they may be affected by engine vibration. Repair any cracked or damaged mounting points. Use suitable reinforcing plates to ensure that the insulators will remain in position.

Inner Fender Shields and Cab Skirts**Fasteners**

Check all fasteners for security, especially the self-tapping hex head screws. Remove and replace any loose rivets.

Shields and Skirts

- Check shields and skirts for cracks at mounting and stress points. Check fender shields for tire marks, worn spots, or damage from objects thrown from tire treads. You can repair cracked or damaged fiberglass fender shields with fiberglass and resin.
- If you find damage at a fastening point, you can gain additional strength by installing a suitable reinforcing plate. This plate should be drilled to accept a rivet and laminated to the shield with fiberglass and resin.
- Check cab skirts, sills, and brackets for overall condition and repair them as necessary. Damaged rubber fender shields or cab skirting cannot be repaired. You will need to replace it.

Your authorized dealership can perform all of these checks and repairs or replacements.

Air Intake System

- Do all checks and maintenance chores listed in this manual under Engine Air Intake System and Air Cleaner (See Index).
- Check the induction tubing, elbow connections, clamps, brackets, and fasteners for deterioration, cracks, and security. If you find an air leak anywhere between the air cleaner and the engine, repair that leak immediately.



CAUTION: Air leaks cause excessive noise and may result in serious damage to the engine. If you do not repair them the engine damage won't be covered by your warranty. Repair all air leaks as soon as you find them.

Table 16 Noise Control System Maintenance Logs

COMPONENT	RECOMMENDED INTERVAL (MILES)	DATE & R.O. NUMBER	REPAIR FACILITY & LOCATION	WORK PERFORMED	DATE & R.O. NUMBER	REPAIR FACILITY & LOCATION	WORK PERFORMED
Exhaust System Routing Integrity	25,000						
Shutters Shrouds	25,000						
Hood Insulation Blanket	10,000						
Engine-Mounted Hose Insulators Fasteners	10,000						
Inner Fender Shields	50,000						
Cab Skirt Fasteners	50,000						
Air Intake System Integrity Element	5,000						
Clutch-Type FanDrive	10,000						

PART 9: VEHICLE IDENTIFICATION NUMBERS

Each vehicle completed by Peterbilt Motors Company uses a Vehicle Identification Number (VIN) that contains the model year designation of your Peterbilt. The practice is in compliance with 49 CFR 565, Code of Federal Regulations.

All Peterbilt vehicles are identified by a 17-digit Vehicle Identification Number (VIN). This unique numeral and letter combination identifies the manufacturer, the model year it was built, and other vehicle attributes. The VIN is in compliance with 49CFR565, Code of Federal Regulations. As an example, the model year and assembly plant are designated by a letter in the tenth and eleventh character positions (see 4 and 5 below).

EXAMPLE VIN: 1XP9D2X96XD345678

1XP	9D2X9	6	X	D	345678
1	2	3	4	5	6

VIN characteristics

- 1 Manufacturer Identifier
- 2 Vehicle Attributes
- 3 Check Digit
- 4 Model Year
- 5 Assembly Plant
- 6 Serial/Chassis number

Model Year Codes

9	2009
A	2010
B	2011
C	2012
D	2013
0 (ZERO)	Glider Kit

PART 10: CONSUMER INFORMATION

Federal Safety Standard Certification Label

The National Highway Traffic Safety Administration regulations require a label certifying compliance with Federal Safety Standards, for United States and U.S. Territories, be affixed to each motor vehicle and prescribe where such label may be located.

This certification label, which indicates the date of manufacture and other pertinent information, is located on the left hand cab door post.

MANUFACTURED BY PETERBILT MOTORS CO. P.R. GVWR		SUITABLE TIRE-RIM CHOICE		THIS VEHICLE CONFORMS TO ALL APPLICABLE FEDERAL MOTOR VEHICLE SAFETY STANDARDS IN EFFECT ON THE DATE OF MANUFACTURE SHOWN ABOVE	
DIVISION OF PACCAR Inc. 2ND GVWR	TIRE SIZE	RIM SIZE	PSI COLD	VIN	
DATE MFD				TYPE, USE, TIRE SIZE OR LOADING INSTRUCTIONS	
GVWR	4TH GVWR				

02955

How To Order Parts

When you need replacement parts for your Peterbilt vehicles, contact your nearest authorized Peterbilt dealer, who may be located from the "Peterbilt Authorized U.S. and Canadian Dealers" listing (Cat. No. 5212).

When you order, it is IMPORTANT that you have the following information ready:

- Your name and address.
- Serial number of the truck.
- The name of the part you need.
- The name and number of the component for which the part is required.
- The quantity of parts you need.
- How you want your order shipped.



NHTSA Consumer Information

If you believe that your vehicle has a defect which could cause a crash or could cause injury or death, you should immediately inform the National Highway Traffic Safety Administration (NHTSA) in addition to notifying Peterbilt Motors Company.

If NHTSA receives similar complaints, it may open an investigation, and if it finds that a safety defect exists in a group of vehicles, it may order a recall and remedy cam-

paign. However, NHTSA cannot get involved in individual problems between you, your dealer, and Peterbilt Motors Company.

Contacting NHTSA is possible through telephone, written mail and email. NHTSA also has a website where you can input your comments directly to them on the web. Please use any of the four ways to contact NHTSA:

	Toll Free 888-327-4236 (800-4249153 TTY) 8:00 am to 10:00 pm ET Monday-Friday
	Office of Defects Investigations/CRD NVS-216 1200 New Jersey Ave SE. Washington, D.C. 20590
www	www.safercar.gov
@	nhtsa.webmaster@dot.gov

Canadian Consumer Information

Canadian customers, who wish to report a safety-related defect to Transport Canada, Defect Investigations and Recalls, may telephone the toll free hotline 1-800-333-0510, or contact Transport Canada by mail at:

Transport Canada, ASFAD
Place de Ville Tower C
330 Sparks Street
Ottawa ON K1A 0N5

For additional road safety information, please visit the Road Safety website at
<http://www.tc.gc.ca/roadsafety/menu.htm>

Environmental Protection



WARNING! Diesel engine exhaust and some of its constituents are known to the State of California to cause cancer, birth defects, and other reproductive harm. Other chemicals in this vehicle are also known to the State of California to cause cancer, birth defects or other reproductive harm. This warning requirement is mandated by California law (Proposition 65) and does not result from any change in the manner in which Peterbilt trucks are manufactured.

Some of the ingredients in engine oil, hydraulic oil, transmission and axle oil, engine coolant, diesel fuel, air conditioning refrigerant (R12, R134a, and PAG oil), batteries,

etc., may contaminate the environment if spilled or not disposed of properly. Contact your local government agency for information concerning proper disposal.

State of California

California Proposition 65 Warning

Diesel engine exhaust and some of its constituents are known to the State of California to cause cancer, birth defects, and other reproductive harm.

Other chemicals in this vehicle are also known to the State of California to cause cancer, birth defects or other reproductive harm.

Battery posts, terminals, and related accessories contain lead and lead compounds, chemicals known to the State of California to cause cancer and reproductive harm. Wash hands after handling.

California Vehicle Code, Section 9951 - Disclosure of Recording Device

Your vehicle may be equipped with one or more recording devices commonly referred to as “event data recorders (EDR)” or “sensing and diagnostic modules (SDM)”. If you are involved in an accident, the device(s) may have the ability to record vehicle data that occurred just prior to and/or during the accident.

For additional information on your rights associated with the use of this data, contact

the California Department of Motor Vehicles - Licensing Operations Division

or

http://www.dmv.ca.gov/pubs/vctop/d03_6/vc9951.htm

PART 11: SUBJECT INDEX

A

- Anti-lock brakes [109](#), [213](#)
- Appearance [218](#)
- Appliances in the Cab [72](#)

B

- Battery
 - compartment cover [201](#)
 - electrolyte [196](#)
 - recharging [196](#)
 - slow battery charging [198](#)
- Belts, seat [77](#)
- Brake
 - operation [109](#)
- Brake system
 - Electronic Stability Control [111](#)
 - truck & tractor [109](#)

C

- Cap Nut Torque Specifications [187](#)
- Cleaning the vehicle [218](#)
- Consumer Information [230](#)
- Controls
 - Air Horn [41](#)
 - Air Suspension Deflate Switch (Dump Valve) [45](#)
 - Brakesaver [49](#)
 - Cigarette Lighter [58](#)

- Cruise Control Switch [48](#)
- Dome Light Switch [44](#)
- Electric Horn [40](#)
- Engine Brake [49](#)
- Engine Fan Switch [46](#)
- Fifth Wheel Lock (Slider Adjustment) Switch [52](#)
- Fog Lights Switch [44](#)
- Hazard Flasher [39](#)
- Headlamps [42](#)
- Headlights [42](#)
- Heater-Air Conditioning Controls [54](#)
- Interaxle Differential Lock Switch [50](#)
- Manual Override [42](#)
- Mirror Heat Switch [47](#)
- Panel Light Knob [43](#)
- Parking Brake Valve and Trailer Air Supply Valve [53](#)
- Power Mirror Switch [47](#)
- Tilt- Telescoping Steering Column [41](#)
- Trailer Brake Hand Valve [40](#)
- Turn Signal and Indicator Lights [35](#)
- Windshield Wipers and Washers [37](#)
- Cooling system
 - coolant level [194](#)
 - extended life coolant [191](#), [193](#)
 - temperature [65](#)
 - topping up [193](#)

D

- Dash [14](#)
- DEF [67](#), [205](#)
- Defogging/defrosting system [57](#)
- Deisel Exhaust Fluid [205](#)
- Deisel Exhaust Fluid Tank [205](#)
- Door lock [218](#)
- Driver Information Display [30](#)
- Driver's Checklist [88](#)
- Driving
 - vehicle inspection [88](#)

E

- Electrical system
 - batteries [197](#)
 - battery charging [198](#)
 - jumper cables [199](#)
- Electrolyte [196](#)
- Emission, Diesel Exhaust Fluid Lamp [26](#)
- Emissions, Diesel Particulate Filter (DPF) [25](#)
- Emissions, Malfunction Indicator Lamp [26](#)
- Engine
 - overspeed [141](#)
- Engine Warmup [95](#)
- Environmental Protection [231](#)
- Exhaust fumes [144](#)

F

- Federal motor vehicle safety standards [5](#)
- Federal Safety Standard Certification Label [230](#)

- Frame Fastener Torque Specifications [208](#)

G

- Gauges and Displays [59](#)
 - Air Application Gauge [63](#)
 - Air Filter Restriction Indicator or Gauge [70](#)
 - Engine Oil Pressure Gauge [64](#)
 - Fuel Gauge [66](#)
 - Manifold Pressure Gauge [69](#)
 - Primary And Secondary Air Pressure Gauges [63](#)
 - Pyrometer [70](#)
 - Speedometer / Odometer [30](#)
 - Speedometer-Message Center [60](#)
 - Tachometer [61](#)
 - Voltmeter [70](#)
 - Warning Lights and Buzzers [17](#)
 - Water Temperature Gauge [65](#)
- Glove Compartment [59](#)
- GVWR - gross vehicle weight rating [179](#), [183](#)

H

- Headlamp
 - adjustment [201](#)
- Heater and air conditioner [57](#)
- HEST warning lamp [128](#)
- High beam [36](#)
- High Exhaust System Temperature (HEST) warning lamp [127](#)
- hood anti-blowdown device [12](#)
- Hood Tilting [11](#)

JJumper cables [199](#)**K**Keys [7](#)

Keys and Locks

Ignition Switch [41](#)**L**

Lubrication

Axle [169–170](#)coasting [141](#)Steering Gear [171](#)Transmission [165–??](#)types and brands [161](#)Universal Joint [171](#)Wheel Bearing [170](#)Lubrication Index [163](#)Luggage Compartment(s) [71](#)**M**Maintenance Schedule [143](#)Menu Control Switch (MCS) [15](#), [17](#)Mirrors [71](#)**N**Navigation System [73](#)Noise Control System [222](#)**P**Parked Regeneration [131](#)parked regeneration [51](#)

Parking brake

brake system, operation [53](#), [119](#)use [143](#)**R**

Rear suspension

fasteners (standard) [208](#)Refrigerator [72](#)Regeneration Switch [16](#), [51](#)Restraint Systems [75](#)Inspection [83](#)Komfort-Lok® Feature [79](#)Shoulder Belt [76](#)Sleeper Bunk Restraints [80](#)Tether Belts [82](#)**S**Safe vehicle operation [88](#)Safety stands [144](#)Seat [75](#)Seat adjustment [75](#)Seats [75](#)

Servicing Specific Systems

Air Intake System [212](#)Air System [188](#)Anti-lock Braking System (ABS) [213](#)Brake Adjustment [173](#)Cab Heater-Air Conditioner [215](#)Electrical [195](#)Engine Accessories [210](#)

Engine Cooling System [191](#)
 Fasteners [208](#)
 Steering [207](#)
 Tires, Wheels, And Rims [177](#)
 Transmission And Drive Train [203](#)
 Shifting gears [141](#), [142](#)
 Standard Capscrew Torque Specifications [209](#)
 Starting and Operating [93](#)
 Anti-Lock Braking System [108](#)
 Automated Transmission [105](#)
 Auxiliary Transmission [105](#)
 Bobtail Brake Proportioning System [117](#)
 Brake Safety and Emergency [117](#)
 Digital Message Center [117](#)
 Driving Bobtail or with an Unloaded Trailer [126](#)
 Driving With Deflated Air Springs [139](#)
 Dual Range (Two Speed) Axles [103](#)
 Idling the Engine [97](#)
 If Your Vehicle Must Be Towed [105](#)
 Interaxle Differential [101](#)
 Manually Releasing Spring Brakes [121](#)
 Operating the Clutch [99](#)
 Overheated Brakes [118](#)
 Parking Brakes and Their Use [118](#)
 Retarders [125](#)
 Setting Ride Height [136](#)
 Shifting The Transmission [99](#)
 Starting Procedure
 Cold Temperature [94](#)

 Normal Temperature [93](#)
 Stopping The Engine [134](#)
 Trailer Air Supply Valve [120](#)
 Suspension
 fasteners, torque [208](#)

T

Tachometer [142](#)
 Tire Load and Inflation Tables [182](#)
 towing [106](#)
 Transmission
 lubrication [165](#)
 warmup [97](#)

U

Units of Measure [35](#)

V

Vehicle
 driving [88](#)
 Vehicle inspections [88](#)
 Vehicle weight rating [183](#)

W

Warning Light / Indicator Symbols [20](#)
 Warning Light Symbols table [20](#)
 Warning Light/Indicator Symbol Descriptions [23](#)
 Wheels and tires
 load rating [179](#)
 replacement [177](#)
 Windshield washer reservoir [38](#)

Numerics

49 CFR 565, Code of Federal Regulations [229](#)