

TATA XENON

Owner's Manual & Service Book

This owner's manual should be considered as a permanent part of the vehicle and must remain with the vehicle.

TATA MOTORS

● Mumbai ● Pune ●

Edition :

^{2/21} **This Owner's Manual should be kept in the vehicle at all times.**

^{2/21} **This book will help you to understand the vehicle better, maximise uptime of the vehicle & obtain better performance at optimum cost.**

^{2/21} The recommended routine maintenance servicing along with any running repairs that may be required, should be entrusted to a **TATA MOTORS** Authorised Workshop to ensure that only latest methods and genuine **TATA MOTORS** replacement parts are used for the continued reliability, safety and performance of the vehicle.

^{2/21} Some of the items / accessories / features shown / given in this book may not be fitted on your vehicle, but they are applicable for other versions of **XENON**.

^{2/21} **(C) Copyright 2004 TATA MOTORS**

^{2/21} All rights reserved. The material in this manual may not be reproduced or copied, in whole or in part, in any form without written permission from **TATA MOTORS**.

^{2/21} The information and specifications given in this book are valid as on the date of printing. **TATA MOTORS** Limited reserves the right to make changes in design and specifications and/or to make additions to or improvements in this product without obligation to install them on products previously sold.

^{2/21} In the event of the Vehicle being sold, please ensure that this manual is left in the vehicle for the reference of the new owner.

DEAR CUSTOMER,

We are pleased to hand over to you a **TATA XENON** vehicle manufactured by **TATA MOTORS** where **quality** is the watchword and major attention is paid even to minor details at all stages of manufacture.

Please carefully read this book, it helps you to know your vehicle better, to ensure your vehicle is ready for operation at all times and to obtain better performance at optimum operating costs.

All service and maintenance tasks should be carried out at the specified service intervals.

Some of the items / accessories / features shown / given in this book may not be applicable for your vehicle, but may apply to other versions of this model.

For any further assistance, kindly contact the nearest **TATA MOTORS** authorised workshop dealership or our offices.

We wish you good luck and prosperity.

TATA MOTORS LIMITED

Know your Xenon 6

Warranty - Terms & Condition	8
Environmental Care	10

Xenon At A Glance

Driving Controls	12
Instrument Cluster	13
Steering Lock and Ignition Switch	20
Combi Switch	21
Head Lamp Levelling	24
Transfer Case Switch	25
Music System, Analog Clock & Antenna	26
Heating, Ventilation & Air Conditioning	27
Grab Handle & Cigarette Lighter	32
Lamps	33
Sun Visor & Mirrors	36
Rear View Mirror	37
Glove Box, Cup Holder & Utility Pockets	38
Window Glass Operations	39
Fuel Flap Opening	40
Gear Shift Lever & Parking Brake	41
Anti Theft / Immobiliser System	42

Getting Started

Key & Door Lock	50
Child Lock	51
Seats, Seat Adjustments & Seat Belts	52
Steering Wheel Adjustment	56

Driving

Checks Before Driving	57
Safety Checks	58
Fuel Saving Tips	59
Starting & Stopping The Engine	61
Gear Shifting	62
Braking	66
Driving In Adverse Conditions	67

Incase Of Emergency

Jack Location / Warning Triangle	69
Flat Tyres Replacement	69
Spare Wheel	71
Limp Home Mode	72
Starting The Engine With Jump Leads	73

Towing The Vehicle 72

Routine Service 73

Preliminary Trouble Shooting 74

Electrical Maintenance

Fuses & Relays 82

Bulb Specification 84

Bulb Replacement 85

Vehicle Care

Washing & Cleaning 87

General Precautions 89

Maintenance

Opening & Closing The Bonnet 90

Engine Compartment 91

Air Filter, Engine, & Engine Oil Level 92

Engine Coolant & Brake Fluid Level 93

Power Steering Fluid Level 94

Load Conscious Pressure Reducing Valve 95

Clutch Fluid & Sedimenter 96

Fuel Filter & Priming Pump 97

Windshield Washer & Tyre 98

Repair of Tyre / Tube 99

Tyre Rotation 100

Wheel Alignment, Balancing & Catalytic Converter Maintenance 101

Battery 102

Important Technical Information

Fuel, Lubricants & Coolants 103

Oil Filling & Drain Points 106

Technical Specification 107

Information At a Glance (Dimensions) 110

Vehicle Identification

Location of Aggregate Number 111

PDI Service 113

Service Schedule 117

Service Maintenance Schedule 119

Record of Services Performed 124

Record of Repairs Carried Out 126



TATA XENON is a versatile vehicle. It incorporates well known and proven features of Tata Motors precision and advanced technology. Easy maneuverability and economic life cycle cost make this vehicle ideal for urban and rural areas for operation as pick-up truck, delivery van, service van, etc.

TATA XENON comes equipped with a TATA DICOR engine with BS-III compliant norms and having a 5 speed full synchromesh gearbox with overdrive 5th for excellent fuel efficiency and tough road gripping tyres for added traction.

The DICOR Engine has a sophisticated common rail fuel system. It consists of ECU, sensors and actuators. The electronic control unit (ECU) is a 32 bit microprocessor which controls engine fuel injection parameters and other vehicle related parameters. The ECU receives input from various sensors fitted to the engine and on the vehicle to decide fuel injection quantity, fuel timing and number of injections best suited for the engine to work with maximum fuel efficiency and safety.



Other features like vacuum assisted independent hydraulic brakes on front and rear wheels through tandem master cylinder and tandem booster. Also ventilated front brake discs with twin port calipers provides better braking efficiency and greater safety. Telescopic shock absorbers and an antiroll bar make up the front independent suspension set-up. Parabolic springs coupled at the rear ensure good road holding and stability.



An ergonomically designed cabin with added features such as adjustable steering column, central locking, headlamp leveling, power windows, rotary HVAC controls, electronic cluster, internally adjusted ORVM for good all-round visibility. Easy access to areas of daily maintenance are some of the other user-friendly features.

WARRANTY - TERMS & CONDITIONS

WE WARRANT each **TATA XENON** vehicles & parts thereof manufactured by us to be free from defect in material and workmanship, subject to the following terms & conditions :

1. This warranty shall be for 24 months OR 75000 kms, whichever is earlier from the date of sale of the vehicle. However, for the vehicles used for commercial applications (including those used for hire or reward viz those operating with a yellow number plate), the warranty shall be limited to 24 months or 50,000 kms, whichever occurs earlier.
2. Our obligation under this warranty shall be limited to repairing or replacing, free of charge, such parts of the vehicle which, in our opinion, are defective, on the vehicle being brought to us or to our dealers within the warranty period. The parts so repaired or replaced shall also be warranted for quality and workmanship but such warranty

shall be co-terminus with this original warranty.

3. Any part which is found to be defective and is replaced by us under the warranty shall be our property.
4. As for such parts as tyres, batteries, transfer case, rubber parts, electrical equipment and fuel injection equipment, power steering equipment, A.C. equipment not manufactured by us but supplied by other parties, this warranty shall not apply, but buyers of the vehicle shall be entitled to, so far as permissible by law, all such rights as we may have against such parties under their warranties in respect of such parts. Our Dealers/TASC's will assist the purchaser in taking up the complaint with the respective manufacturers and their decision on the warranty will be final.
5. This warranty shall not apply if the vehicle or any part thereof is repaired or altered otherwise than

in accordance with our standard repair procedure, or by any person other than our sales or service establishments, our authorised dealers or service centres or service points in any way so as, in our judgement which shall be final and binding, to effect its reliability, nor shall it apply if, in our opinion which shall be final and binding the vehicle is subjected to misuse, negligence, improper or inadequate maintenance or accident or loading in excess of such carrying capacity as certified by us, or such services as prescribed in our Owner's Manual and Service Book are not carried out by the buyer through our sales or service establishments, our authorised dealers or service centres or service points.

6. This warranty shall not cover normal wear and tear or any inherent normal deterioration of the vehicle or any of its parts arising from the actual use of the vehicle or any damage due to negligent or improper operation or

storage of the vehicle. This warranty shall not apply to normal maintenance services viz. oils & fluid changes, head lamps focussing, fastener retightening, wheel balancing, tyre rotation, adjustment of valve clearance, fuel timing, ignition timing and consumables like bulbs, fuel filters and oil filters etc. This warranty shall not apply to any damage or deterioration caused by environmental pollution or bird droppings. This warranty shall not apply to V-belts, hoses and gas leaks in case of air conditioned vehicle. Slight irregularities not recognised as affecting the function or quality of the vehicle or parts such as slight noise or vibration and defects appearing only under particular or irregular operations or items considered characteristic of the vehicle.

7. This warranty shall be null and void if the vehicle is subjected to abnormal use such as rallying,

racing or participation in any other competitive sports. This warranty shall not apply to any repairs or replacement as a result of accident or collision.

8. This warranty is expressly in lieu of all warranties, whether by law or otherwise, expressed or implied, and all other obligations or liabilities on our part and we neither assume nor authorise any person to assume on our behalf, any other liability arising from the sale of the vehicle or any agreement in relation thereto.
9. The buyer shall have no other rights except those set out above and have, particular, no right to repudiate the sale, or any agreement or to claim any reduction in the purchase price of the vehicle, or to demand any damages or compensation for losses, incidental or indirect, or inconvenience or consequential damages, loss of vehicle, or loss of time, otherwise, incurred or accrued.

10. Any claim arising from this warranty shall be recognised only if it is notified in writing to us or to our concerned dealer without any delay soon after such defect as covered and ascertained under this warranty.

11. This warranty shall stand terminated if the vehicle is transferred or otherwise alienated by the buyer without our prior written consent.

12. We reserve our rights to make any change or modification in the design of the vehicle or its parts or to introduce any improvement therein or to incorporate in the vehicle any additional part or accessory at any time without incurring any obligation to incorporate the same in the vehicles previously sold.

ENVIRONMENTAL CARE

TATA MOTORS is committed to producing vehicles using environmentally sustainable technologies. A number of features have been incorporated in **TATA Vehicles** which have been designed to ensure environmental compatibility throughout their life cycle. We would like to inform you that your vehicle meets appropriate environmental norms and this is being regularly validated at all stages of manufacturing.

As a user, you too can protect the environment by operating your vehicle in a proactive manner. A lot depends on your driving style and the way you maintain your vehicle. The following points are provided for your guidance.

Driving

- Avoid frequent and rapid acceleration.
- Do not carry any unnecessary weight on your vehicle as it overloads the engine.
- Avoid using devices requiring high power consumption during slow traffic condition.
- It is not advisable to warm up the engine during first start of the day by idling, as cold temperatures within engine could cause rise in the emissions such as CO & HC particulate.
- Monitor fuel consumption regularly and if it shows a rising trend, get the vehicle immediately attended by an authorised Tata dealer.
- Switch off engine during long stops at traffic jams or signals. If situation demands that engine be kept running, avoid frequent

revving of the engine. Also avoid frequent stopping and restarting, if uncalled for.

- It is not necessary to rev the engine before turning it off.
- Shift to higher gears as soon as possible. Use each gear up to 2/3rd of its maximum engine speed. Recommended gear shift speed are furnished in this manual.

Maintenance

- Ensure that periodical services are carried out regularly by an authorised Tata dealer.
- As soon as you see any leakages of oil, fuel, air or coolant, get it attended to immediately.
- Use only recommended brands and grades of lubricants and clean/uncontaminated fuels.
- Get your vehicle checked for emission periodically by an authorised Tata dealer.

- Ensure that fuel filters, oil filter etc. are replaced at recommended intervals.
- Do not pour used oils or coolants into sewage drains, garden soil or open streams. Dispose used filters and batteries in compliance with local laws.
- It is not recommended that unauthorised workshops tamper with the engine settings or to carry out modifications on the vehicle.
- Avoid running the vehicle out of fuel, as it can result in engine misfire.
- Please adhere to recommended fuel specifications while filling up top.

While carrying out servicing or repairs, you should pay keen attention to components given below which affect emission.

- 1. Fuel injection pump, injectors.**
- 2. Air intake and Exhaust system.**
- 3. Cylinder head for valve leakage.**
- 4. All filters such as air, oil and fuel filters.**
- 5. Turbocharger and intercooler (if fitted.)**
- 6. EGR system components & Electrical connections.**
- 7. Glow plug timer.**
- 8. Catalytic convertor.**

DRIVING CONTROLS

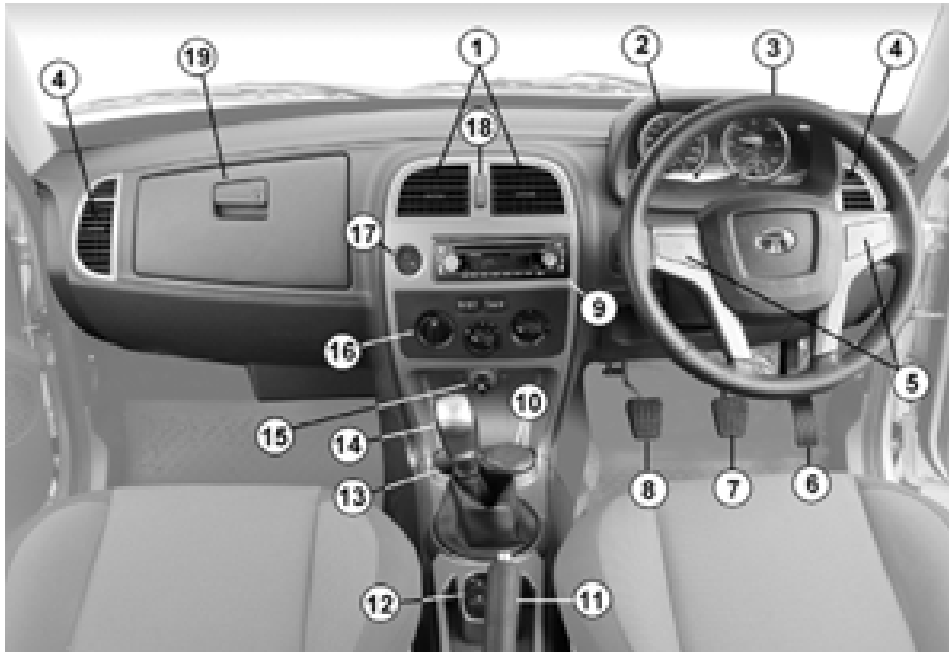

1. *Air Vents*
2. *Instrument Cluster*
3. *Steering Wheel*
4. *Side Air Vents*
5. *Horn Pad*
6. *Accelerator Pedal*
7. *Brake Pedal*
8. *Clutch Pedal*
9. *Music System*
10. *Ash Tray*
11. *Parking Brake*
12. *Power Window Switches*
13. *Cup Holder*
14. *Gear Shift Lever*
15. *Cigarette Lighter*
16. *A.C. Controls*
17. *Analog Clock*
18. *Hazard Warning Switch*
19. *Glove Box*

INSTRUMENT CLUSTER



Xenon At a Glance

INSTRUMENT CLUSTER

1. Front Fog Lamp Indicator (Green)
2. 'Check Engine' Indicator (Red)
3. Door Open Indicator (Red)
4. High Water Level Indicator in Sedimentor (Amber)
5. 4WD Low (For 4x4 Vehicles Only) (Green)
6. 4WD High (For 4x4 Vehicles Only) (Green)
7. Rear Fog Lamp Indicator (Amber)
8. MIL Indicator (Amber) If fitted
9. Anti - Theft Indicator (Red)
10. Glow Plug "ON" Indicator (Amber) - If fitted
11. Direction Indicator (Green)
12. Head Lamp Main Beam Indicator (Blue)
13. Engine Low Oil Pressure Indicator (Red)
14. Battery Charging Indicator (Red)
15. Brake Fluid Level Check/Parking Brake Indicator (Red)
16. Seat Belt Indicator (Red)
17. Trip Odometer
18. Cumulative Odometer
19. Mode Selector Knob (Odometer)
20. Set Knob (Odometer)
21. High Temperature Warning
22. Low Fuel warning
23. Over Speed Indicator
24. Speedo Meter
25. RPM Meter
26. Fuel Gauge
27. Temperature Gauge

Front Fog Lamp Indicator (Provision):



This symbol (Green coloured) lights up when the front fog lamps are switched 'ON'

Check Engine Indicator:



This indicates engine condition, when a malfunctioning occurs in the Engine or EMS (Engine Management System). It Remains "OFF" in "IGN" position OR Remains "ON" in running position.

CAUTION

When Engine Check Indicator comes ON, get the problem attended immediately, at the earliest, at an Authorised service outlet.

Door Open Warning:



Prior to driving ensure that all the doors are properly closed. If any one of the doors is partially open, the door open indicator will come on. In addition to this, if driver's side door is not properly closed an audio beep will sound for a few seconds, when the key is inserted.

Water in fuel sedimenter indicator:



This light comes on when there is excess water in the fuel sedimenter. In this case it is recommended to take your vehicle to nearest service outlet or drain the water from the sedimenter yourself. Please refer to fuel filter and fuel system in maintenance section.

4H, 4L Indicator:

(* For 4WD model only)



With ignition 'ON' and transfer case

switch in 2H mode both 4H and 4L indicator light on instrument panel should glow for a few seconds only and go 'OFF'. Continuous illumination indicates an electrical fault. Do not run the vehicle if both 4H and 4L indicator are ON. The 4H or 4L indicator light will glow only when the transfer case is either in 4H or 4L mode.

Rear Fog Lamp Indicator (Provision):



This symbol (Amber coloured) lights up when the rear fog lamps are switched 'ON'.

Turn Signal:



Turn signal lamps can be operated only when the ignition supply is 'ON' and by using the turn indicator switch on the combi switch. The direction indicator arrow ◀ (LHS) and ▶ (RHS) on the instrument

INSTRUMENT CLUSTER

cluster flashes along with external indicator lights as selected.

High Beam Indicator:



Symbol lights up when the headlamp high beam is 'ON'.

Low Oil Pressure Indicator:



When the ignition key is turned to the 'IGN' position, symbol lights up and goes off as soon as the required engine oil pressure is reached after starting the engine.

If the low oil pressure indicator does not glow or remains 'ON' with the 'IGN' on and engine is running, it indicates a fault in the electrical circuit/lubrication system. Check & get the problem attended to at an Authorised Service outlet.

Battery Indicator:



Symbol lights up when the 'IGN' is turned 'ON' and should go 'OFF' after the engine starts.

CAUTION

If it remains 'ON' while the engine is running. It indicates that the alternator is not functioning. Switch off all unnecessary electrical equipment and get the problem attended to at an Authorised Service outlet.

Parking Brake Indicator and Low Brake Fluid Warning Light:



This indicator has multiple functions as follows -

²²¹ It lights up when the parking brake is applied and goes off when parking brake is released.

²²¹ It also lights up when brake fluid level is low.

²²¹ When ignition key is turned to "IGN" position, this indicator lights up and goes off when engine starts.

Seat Belt Indicator:



This indicator comes ON with ignition and goes OFF whenever the drivers seat belt is fastened.

Odometer and Trip meter (on LCD):

The odometer records the total distance the car has been driven. The trip meter can be used to measure the distance traveled on each trip or between fuel fillings. Keep track of the odometer reading & follow the maintenance schedule regularly for meeting service requirements.

Odometer, Trip meter and Illumination intensity control on instrument panel (LCD):

The instrument panel has an LCD to display the following :

Main Odometer (Non- resettable)
- Counts up to 999999 kms

221 Trip meter A (Resettable) -
Counts up to 1999.9 kms

221 Trip meter B (Resettable) -
Counts up to 1999.9 kms

221 Intensity level of instrument panel illumination – selection among preset levels.

LCD has two line display. The first line displays the Odometer count.

The second line displays either of Trip meter A, Trip meter B, Intensity level of panel illumination. The selection and control of functions are done through 'MODE' and 'SET' push buttons (knobs) provided on either side of the LCD.

The 'MODE' knob is used to select one of the Trip meter A, Trip meter B OR Intensity level of panel illumination. Switching among the above three functions can be done by pressing the knob.

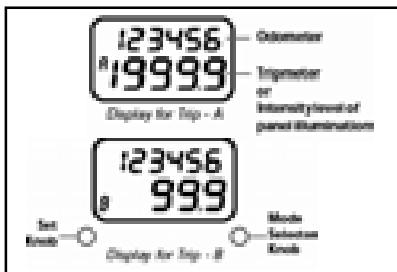

The 'SET' knob is used to control the chosen function. Pressing the knob for a few seconds resets the chosen trip meter and varies the intensity level of instrument panel illumination.

The panel illumination intensity varies among preset levels as follows:

= Min

= = = Max

This display returns to Trip meter A after a few seconds of intensity level selection, if left in this mode.



Intensity Level Indicator

NOTICE

Main Odometer and Trip Meter - A indication will remain on display even if the ignition key is removed.

Xenon At a Glance

INSTRUMENT CLUSTER

Hazard Warning:



This can be operated without ignition 'ON'. Press the hazard warning switch (red knob) on the centre of the dash board, all turn indicator lights will flash simultaneously to warn the other road users about any hazardous condition of the car. Press the knob again to switch 'OFF' the hazard function.

NOTICE

If lights do not blink or blink rapidly, it is an indication of problem in the blinker electrical system or the indicator bulb at front or rear has fused. Get it rectified immediately.

Lock Indicator Warning Light:



If it blinks on the dashboard, vehicle cannot be driven without pressing UNLOCK button on the User remote.

Over Speed Indicator:

It will Indicates when the vehicle speed exceeds 120 km/hrs.

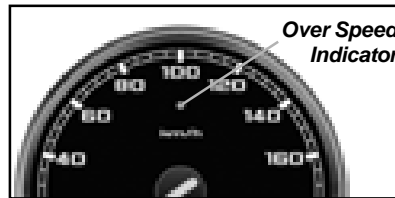

Low Fuel Indicator: (Amber/Orange) :

It comes on when fuel level reaches 10 liters (approx) in tank alerting the user to fill fuel.

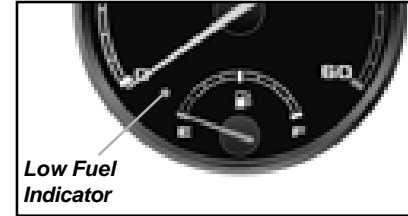

Temperature Gauge:

The gauge indicates the temperature of the engine coolant. The red zone at 'H' indicates temperature higher than the normal. Avoid driving, when the pointer is in the red zone. It indicates engine overheating, which may be due to insufficient coolant in the radiator or due to any other defect. At this stage take the car to the nearest Tata Authorised Service outlet for necessary attention.

Never remove the cap from the coolant reservoir when the engine is hot. Do not restart the engine until the problem has been duly attended.

The speedometer: The speedometer indicates the car speed in km/hr.

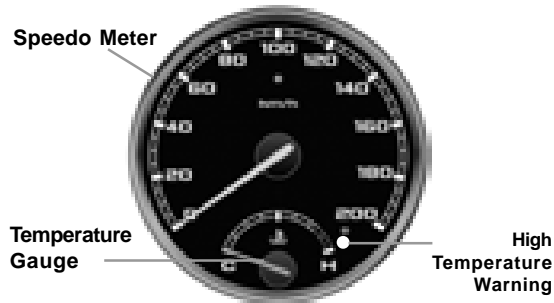

RPM Meter:

The meter indicates engine speed in revolutions per minute (rpm) Change gears at appropriate engine rpm and vehicle speed to get optimum fuel economy. The permitted engine rpm upper limit is the start of Red Zone on the dial.

Fuel Gauge:

The fuel gauge indicates the approximate fuel level in the tank. Refill the fuel tank at the earliest, before the needle touches the red band on the gauge. At this point, approx.10 liters of fuel is remaining in tank and it is advised to get fuel filled immediately



Xenon At a Glance

STEERING LOCK AND IGNITION SWITCH

Steering Lock and Ignition Switch:

Key of ignition switch is common for the door lock, steering lock and glove box lock.

The ignition switch is on the right side of the steering column. It has four positions. Turn the key clockwise for further functions.



- LOCK - Steering Locked
- ACC - Accessories 'ON'
- ON - All electricals 'ON'
- START - Engine crank

LOCK:

You can insert or remove the key only in this position. The steering column is locked when the key is removed.

WARNING

Do not remove the key while driving. It will lock the steering and can cause loss of control. Remove the key only when the vehicle is parked.

ACC:

By turning key to ACC position power supply to accessories is switched ON.

START:

Turn the key further clockwise to the START position (spring loaded) to start the engine. As soon as the engine starts release the ignition key to ON position.

NOTICE

Do not crank the engine more than 10 secs. continuously. If the engine does not start wait for 30 secs. before cranking it again. Release the key immediately after starting the engine otherwise starter motor/flywheel ring may get damaged.

STOP:

By turning the ignition key from ON position to ACC or LOCK position, engine can be stopped.

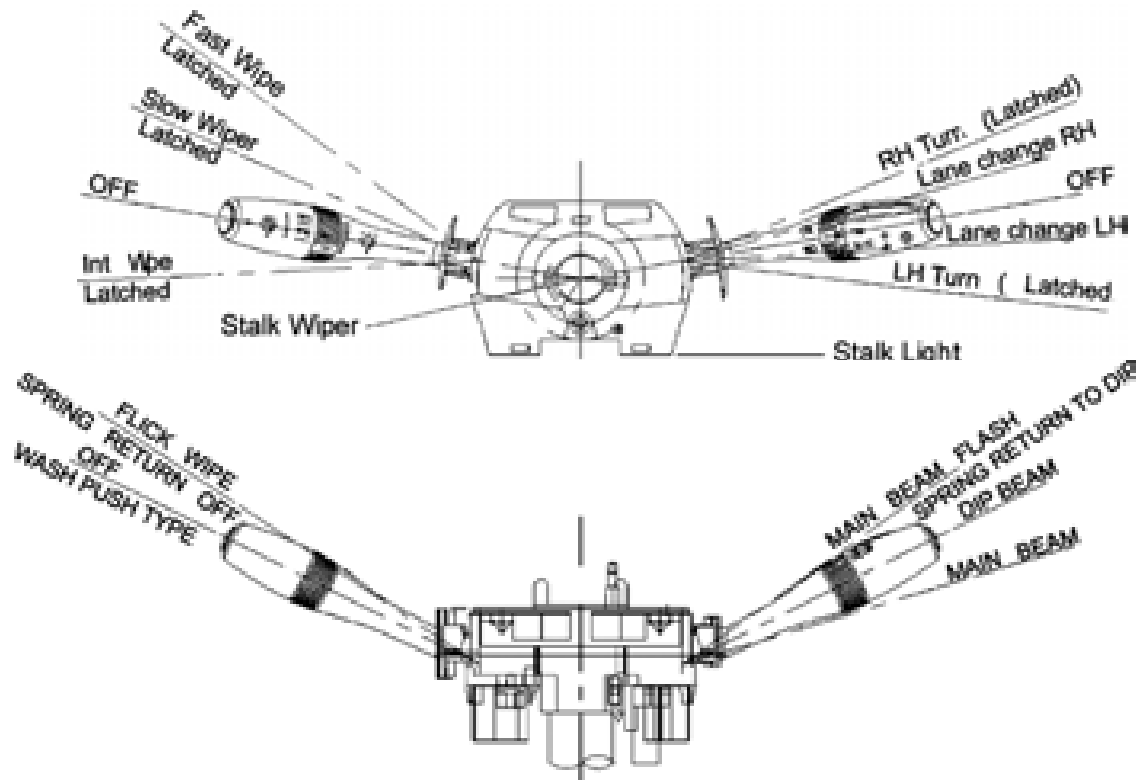

COMBI SWITCH

WIPER CONTROL SWITCH LEVER - LEFT



The selector Knob is used for the Operation of Front & Rear Fog Lamp.

LIGHTS CONTROL SWITCH LEVER - RIGHT

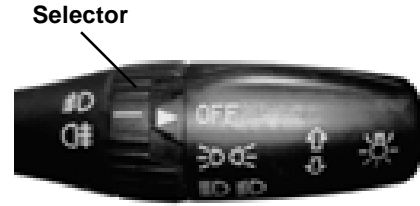

Rotate selector knob to set delay timing for intermittent wipe

After wash function is activated then there will be three wipes of wiper. There will be one more wipe after 5 sec. to clean traces of water on wind screen.

FRONT FOG LAMP SELECTOR SWITCH:

Rotate the Selector switch clock wise to switch on the front for lamp. Front fog lamps are operative only when the head lights are switched ON. Rotate the Selector switch to same direction to switch OFF the front fog lamp.

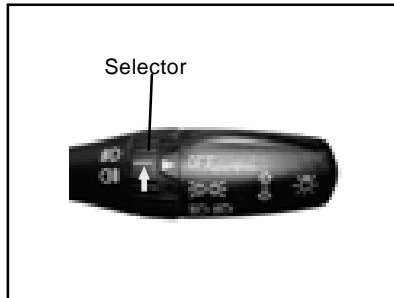
**REAR FOG LAMP SELECTOR SWITCH:**

Rotate the switch anti-clock wise to switch on the rear fog lamp. Rear fog lamps are operative only when the head lights or front fog lamps are switched ON. Rotate the switch to same direction to switch OFF the rear fog lamp.

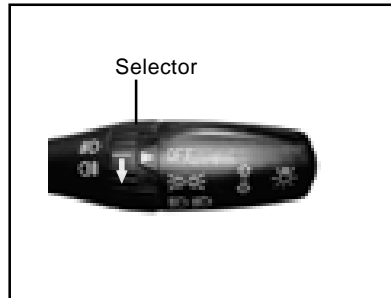
**CAUTION**

If the lights do not blink or blink rapidly, it is an indication of a problem in the blinker electrical system or the indicator bulb at the front or rear has fused. Get it rectified immediately.

Xenon At a Glance

HEAD LAMP LEVELING SWITCH

Head Lamp Leveling Switch:

A motorized head lamp leveling arrangement with the setting knob at the dash board is provided on the centre console. As and when required, head lamp leveling. Setting is done by rotating the knob to select one of the 3 levels marked on the knob depending upon the loading of the vehicle.

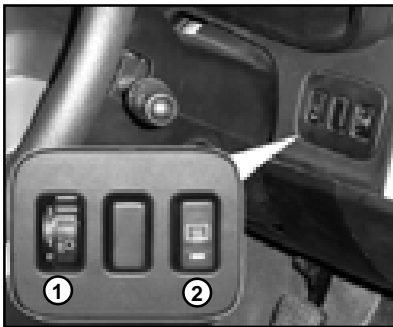

1. Head Lamp Leveling Switch
2. Electrical Demisting Switch

NOTICE

Since the leveling switch takes care of headlamp focus pattern under different load conditions; it is advisable to select the correct position before starting a trip (depending on load).

Loading Condition	Switch position
Unladen / Driver / Driver + Co-driver	0
Driver + Co-driver + All seats occupied	1
Laden + All seats occupied	2
Laden + All seats occupied + permissible luggage load	3



Head Lamp Leveling Switch

TRANSFER CASE SWITCH

Electrical Demisting Switch (If fitted) :

Rear window & Outer Rear view Mirrors are provided with electrical demisting switch for better vision.

Transfer Case Electric Shift Switch (for 4x4 vehicle only) :

It is electrically operated and mounted on dashboard below the instrument cluster. It is a gear selector switch. It has 3 different gear positions 2H, 4H and 4L. They indicate- 2H - 4 x 2

4H - 4 x 4 High

4L - 4 x 4 Low



Location Transfer Case Electric Shift Switch



Transfer Case Electric Shift Switch

Shifting from 2H to 4H or 4H to 2H:

Shifting can be done up to speeds 65 kmph (40mph).

Shifting from 4H to 4L or 4L to 4H :

Shifting to be done only when vehicle is stationary.

Important:

Do not march the vehicle till 4H/4L indicator light stops blinking.

Xenon At a Glance

MUSIC SYSTEM, CLOCK & ANTENNA

Music System (If fitted) :

A provision has been made on all models for fitment of a music system on the facia & for the installation of speakers is made on all doors.

Analog Clock:

The vehicle is fitted with analog clock on the centre console. It has a knob at the bottom of the dial for resetting the time.

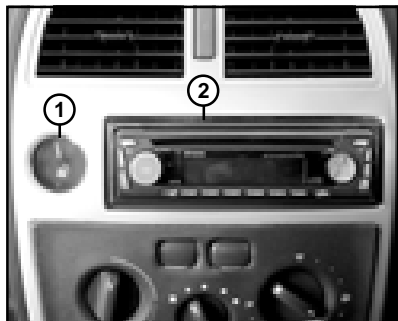

1. Analog Clock
2. Provision for Music System

Analog Clock:

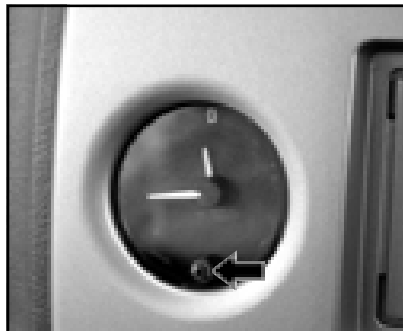

Setting Knob



Speaker Location on Front Door



Speaker Location on Rear Door

Antenna: The antenna is located over the roof.

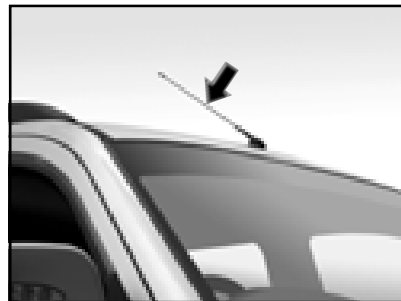

AIR FLOW PATTERN

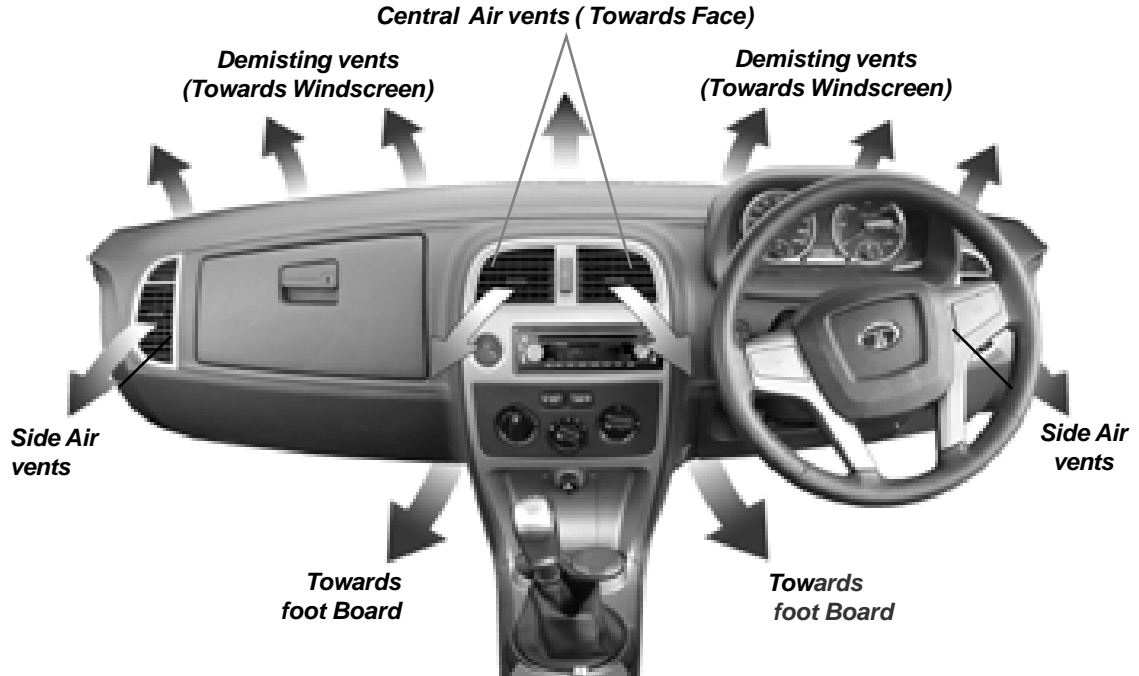

Xenon At a Glance

HEATING, VENTILATION & AIR CONDITIONING (HVAC)

A. Temperature-Control Knob :

The air temperature in the vehicle can be controlled by operating the temperature control knob (A) at the left-hand side of the control panel. The temperature can be increased by rotating the knob towards the red segment and decreased by rotating it towards the blue segment.

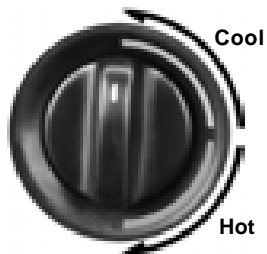

B. Blower Speed Regulation Knob :

The HVAC system has a four speed blower. The blower speeds can be



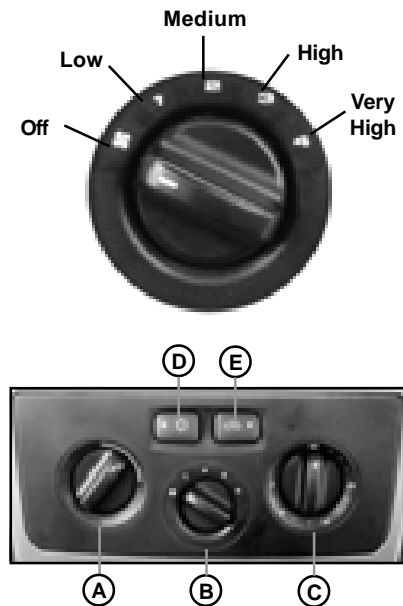

regulated to any one of the following speeds by operating the blower knob (B) centre of the control panel.

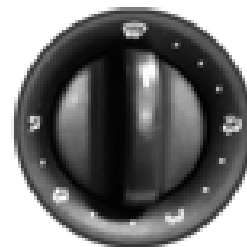

C. Air Direction Control Knob :

The air flow can be changed by turning the knob (C) to the desired direction.



-  Towards face
-  Towards face and feet
-  Towards feet
-  Towards feet and windshield
(Recommended for clearing mist on windshield)
-  Air demist/defrost windshield
(Recommended for clearing heavy fog or snow)

HEATING, VENTILATION & AIR CONDITIONING (HVAC)

D. A. C. ON / OFF Switch :

The A.C. can be switched 'ON' by pressing the switch (D) on the A.C. control panel provided the blower is 'ON' and the engine is running. The indicator lamp will show that the A.C. is 'ON'.

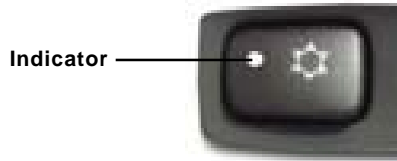
**E. Recirculation / Fresh Air Switch :**

- In HVAC version to put air circulation mode in recirculation, press switch 'E'. The indicator lamp will show air circulation is in recirculation.
- To put vehicle in Fresh mode release switch 'E'. Indicator lamp will be 'OFF'.

- In A.C. version, air circulation mode can be selected by pressing knob 'E'.
- In recirculation mode, air inside the vehicle is circulated again and again. In Fresh mode, air is taken from atmosphere and circulated in the vehicle.

Recirculation mode can be used

- While driving in dusty condition
- To avoid traffic pollution
- To get quick cooling/heating as required.

Whenever discomfort is felt switch air circulation mode to fresh.

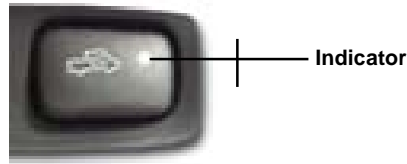
**NOTICE**

- The A.C. can be switched 'ON' only if the blower is 'ON' and engine is running. When A.C. is switched 'ON' engine idling RPM increases marginally, to adjust to the A.C. compressor load. When desired temperature is achieved A.C. trips 'OFF' automatically.
- The A. C. compressor will switch 'OFF' automatically when engine overheats. The A. C. is automatically switched 'ON' when the engine cools down.

HEATING, VENTILATION & AIR CONDITIONING (HVAC)

Normal Heating :

(For vehicles fitted with HVAC & Heating system only)

Knob 'A' - Suitable temperature position

Knob 'B' - Suitable blower speed

Knob 'C' - Towards face & feet

A.C. - OFF

Air Circulation Switch - Fresh

Quick Heating :

All settings as explained before except air circulation switch to recirculation.

Once vehicle is heated, switch back to fresh mode.

Normal Cooling :

A.C. - ON

Knob 'B' - desired speed position

Knob 'C' - towards face

Switch 'E' - suitably as explained

Quick Cooling :

Switch 'ON' the A.C. and keep the blower at maximum speed. Keep air direction in face mode. All vents should be opened completely. Keep the air circulation switch in the recirculation mode and temperature control switch in the maximum cooling (Blue) position. At maximum cooling, A.C. trips off automatically when the desired temperature is achieved.

- In case you find reduction in air flow or foul smell in the passenger compartment clean the evaporator

Demisting :

In rainy season or in areas of high humidity, mist formation inside windshield glass is observed. To clear mist dehumidified air is

passed on the windshield glass.

The position of control knobs should be adjusted as follows :

A.C. - ON

Knob 'B' - Desired speed position

Knob 'C' -

Towards windshield

Knob 'A' (for vehicles fitted with HVAC) - at suitable temperature

Air circulation - at suitable position

NOTICE

When mist clears switch the knob 'C' position to Face mode.

In high humidity areas, if cold air continues to flow over windshield, it may cause sudden fogging on outside surface of windshield.

Defrosting :

(For vehicles fitted with HVAC unit & HD)

In low temperature areas, to clear frost formation outside the windshield glass, this setting is used.

First start the engine and accelerate to warm up.

Knob 'A' - Maximum hot position

Knob 'B' - Very High

Knob 'C' -

Towards windshield



Switch 'E' - Fresh air mode condition

Once the windscreen has become clear, move the fan switch to desired speed.

Ventilator :

The air flow can be adjusted continuously with the rotary control knob at the vents on the dash board. The air vents can be adjusted upward and downward.

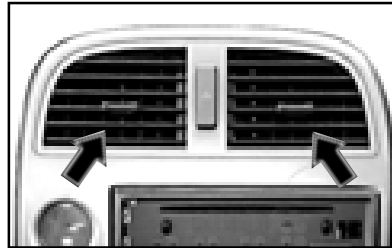

Front Ventilators

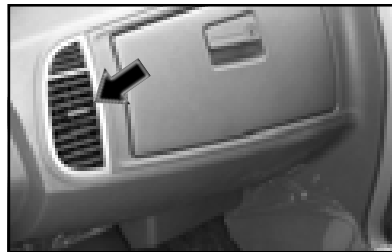

Side Ventilators

NOTICE

- Refrigerant charged in the air conditioning circuit has been identified on the label over front body member. Use only refrigerant as given in the label for topping up or recharge, i.e. do not charge R12 (CFC) in the vehicle earlier charged with R134a (Non CFC) or vice versa.
- Fresh air is taken from the grill opening provided at base of windshield glass outside the vehicle. Keep these openings clear and free from fallen leaves etc.

NOTICE

- AC Gas charging Quantity should be 500 ± 20 gms. (R 134a-Non CFC)

Xenon At a Glance

GRAB HANDLE & CIGARETTE LIGHTER

Roof Grab Handle :

These are provided on all seats except driver seat. This helps in comfortable positioning of passengers during journey.

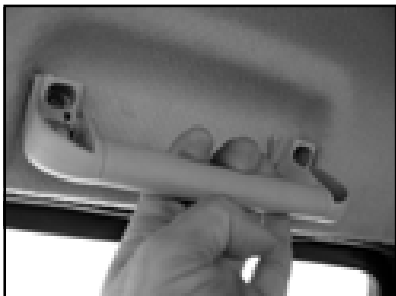

Cigarette Lighter:

With ignition switch in 'ACC' position, press the cigarette lighter fully in. When heated to specified temperature it pops out. Take the lighter out and light your cigarette. After use place the lighter in its position.



NOTICE

- Do not insert any other part or accessory in cigarette lighter slot. It may damage cigarette lighter.
- Do not attempt to touch the hot coil of lighter. It may cause scalding.

Head Lamp:

Head lamps are clear lens type having multi focal reflector and are provided with H4 halogen bulbs with double filament for providing straight ahead illumination of the road for the long distance or dip beam which illuminates the road immediately ahead for short distance visibility. It also contains side indicator lamp and a parking lamp.



- 1 *Main/Dip Beam*
- 2 *Direction Indicator*
- 3 *Position/Parking Lamp*

Tail Lamp:

The tail lamp assembly incorporates the following

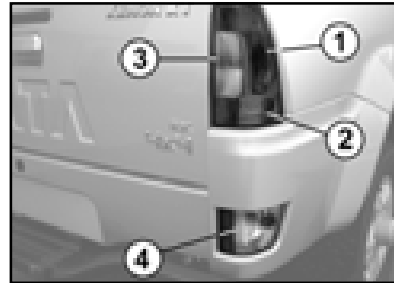

1. *Parking Lamp* 2. *Brake Light*
3. *Direction Indicator* 4. *Fog Lamp*

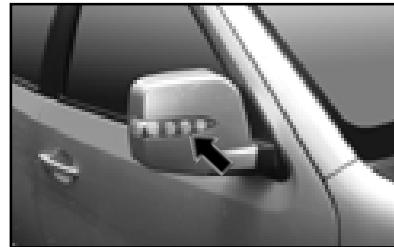
Side Repeater Indicator Lamp**Fog Lamp :**

Front and rear fog lamps are provided for your convenience and they can be operated by rotating the Selector on Combi switch.

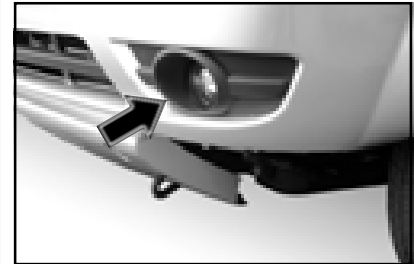
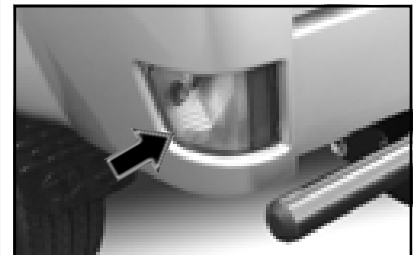
*Front Fog Lamp**4. Rear Fog Lamp*

Xenon At a Glance

LAMPS

High Mounted Stop Lamp:

High mounted stop lamp is provided on the tail gate, and it glows whenever foot brake is applied.

Registration Plate Lamps:

Two concealed lamps are provided for illumination of the rear registration number plate.

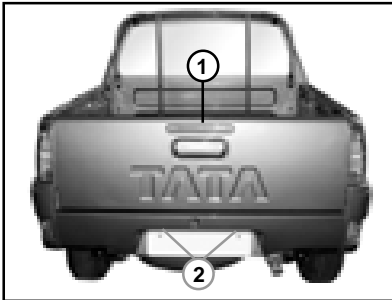

1. High Mounted Stop Lamp
2. Registration Plate Lamps

Door Lamp :

These are provided on the inner side of the front and rear doors to warn the traffic coming from the rear that the door is open.

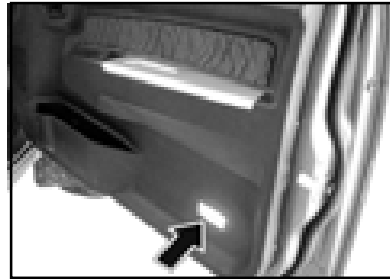

Door Lamp

Door Puddle Lamp :

This is provided on the bottom side of the doors to assist the user for easy entry and exit during night.



Door Puddle Lamp

Engine Compartment Lamp :

This lamp is provided for your convenience in case of engine inspection/service.



Engine Compartment Lamp

Front interior light with reading lamps:

Interior roof lighting and reading lamps with inbuilt switches are provided on the roof near the rear view mirror.



The central rectangular switch has three positions:

ON - The lamp will come 'ON' as long as switch is in this position.

DOOR - In this position the lamp comes on when either of the doors

are opened. When the door is closed, the lamp will not go 'OFF' immediately, but remain 'ON' for 5-8 sec. This helps settling in the seat and inserting the key in the ignition switch. When the key is turned to the 'IGN' position, the lamp goes 'OFF' immediately.

OFF - In this position the lamp will not come 'ON' at all. Two rectangular shaped push type 'ON / OFF' switches are provided separately for the right and left reading lamps.

Rear Reading Lamps (Dual Cab Model Only):

A roof mounted lamp with two reading lamps is provided above the rear seat. One rectangular shaped 'ON / OFF' switch is provided for operating right and left reading lamps.



Turn indicator lamps on outer mirror:

A Stylish turn indicator lamp is provided on outer mirror for better signaling at night driving.



SUN VISOR & MIRRORS

Sun visors:

Two adjustable sun visors are provided inside the cab above the windshield to prevent sun glare. Lower the lower the sun visors to protect the eyes from bright sunlight. The sun visors can also be moved sideways towards the door.

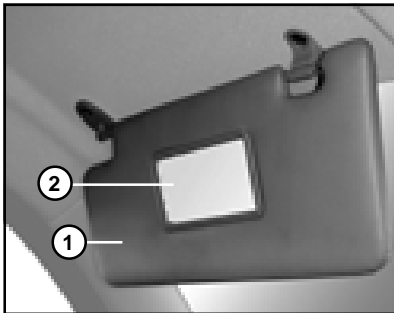

1. Sunvisor 2. Vanity Mirror

A Vanity Mirror has been provided on the back of the Co-driver's sunvisor.

NOTICE

When not in use keep the sunvisors in their original position otherwise they may block the driver's vision.

Inner Rear View Mirror:

Antiglare Mirror - The antiglare mirror is fitted inside the cab. Provision has been made for two positions:

1. Normal position
2. Antiglare position

Use antiglare position only when necessary, as it reduces rear view clarity.

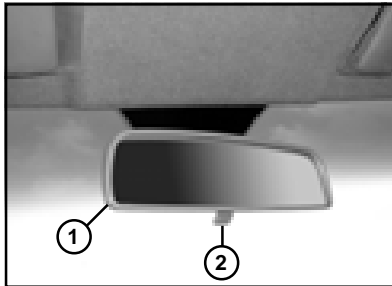

1. *Anti-glare Rear View Mirror*
2. *Operating Knob*

Outer Rear View Mirror:

Motorised Rear View Mirrors are fitted on both front doors and can be adjusted to the desired position with the help of a switch provided on the driver side door. The switch facilitates the driver to adjust the mirrors without lowering the window glasses and without moving from his/her position.

1. Move the main switch to L (for left side) and R (for right side).
2. Use the 4 positions of the knob to adjust the rear view mirrors to correct angles.

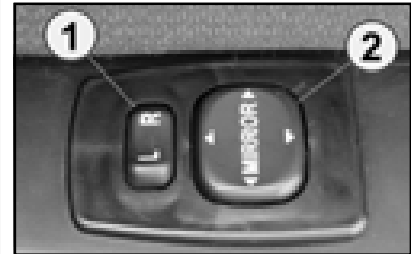

Xenon At a Glance

GLOVE BOX, CUP HOLDER & UTILITY POCKET

Glove Box:

The glove box is located on the dash board in front of the co-driver's seat. The glove box can be locked with the ignition key.



Glove Box

Cup holder , Coin holder and Ash Tray :

These are provided for your convenience.

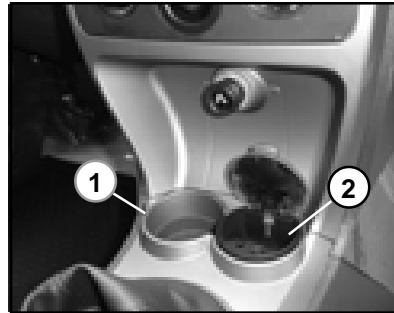

1. Coin holder 2. Ash Tray(Portable)

Utility pocket/box: Utility pocket is provided to the door to keep magazines/books etc.

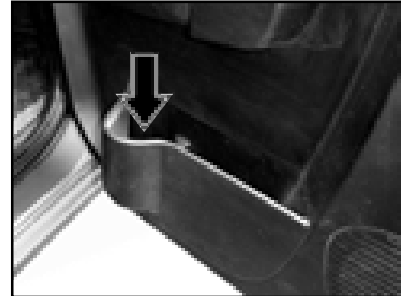

Rear Bottle Holder & utility pocket / box

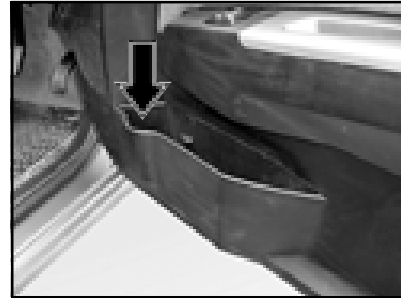

Front Bottle Holder & utility pocket / box

Power Windows :

The windows glasses are electrically operated. Each door has a switch that controls its window. Turn the ignition key to 'ACC' and operate the switch to raise or lower the window.

To open the windows: Driver and co-driver windows are provided with single touch express down feature. Once you push the knob down window will open fully. For rear windows, release the switch when you want the window to stop.

To close the window: Pull the front portion of the switch and hold it. Release the switch when you want the window to stop. Vehicles center console has a main power window control panel by which any of the passenger windows can be operated. When the lock switch is in 'UNLOCK' position, then only the rear windows switches can be operated.

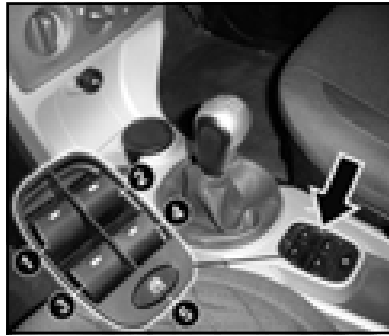

1. Front Left
2. Front Right
3. Rear Left
4. Rear Right
5. Push Type Lock / Unlock Button

WARNING

Ensure that the driver controlled switch is in "LOCK" position when children are in the vehicle to prevent them from injuring by their hands / fingers getting pinched by inadvertent operation / It is the responsibility of the

driver other occupants of the vehicle to ensure that the key is removed from the ignition lock before leaving the vehicle. Keep hands or any part of the body away from the windows while the windows are being wound up/ closed.

Power window switch (On dual cab Rear Doors): Individual window dual cab switches have been provided only on the rear doors.

To close the door window glass pull the knob up and to open, push the knob down

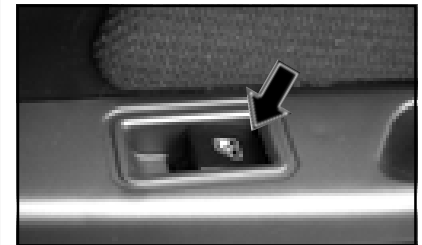

Xenon At a Glance

FUEL FLAP OPENING

Fuel Tank Flap Opening:

The fuel flap is located on the left rear side of the vehicle. The fuel flap can be opened by pulling the opening lever located at the right hand side of the driver seat.

WARNING

Fuel vapour is extremely hazardous. Always stop the engine before refueling and never refuel near sparks or open flames.

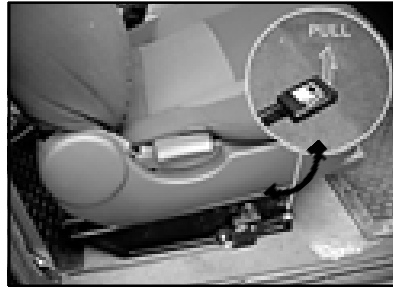

Fuel flap opening lever

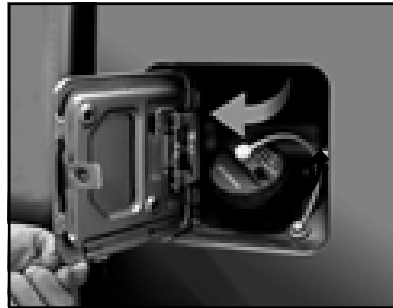

Fuel flap

GEAR SHIFT LEVER & PARKING BRAKE

Gearshift Lever & Shifting Pattern:

The gearshift lever is mounted on the centre console between the two front seats. The gearshift pattern is shown on the gear lever knob.

**NOTICE**

The reverse gear should be engaged only when the vehicle is stationary. Wait for 5 seconds after declutching to ensure smooth engagement of the reverse gear.

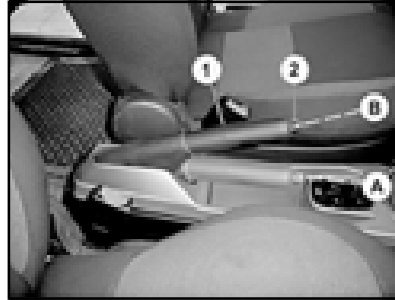
Parking Brake :

1. Parking brake lever

2. Release Button

A. Parking brake Released Condition

B. Parking brake Applied Condition

The mechanical parking brake which acts only on the rear wheels is provided on your vehicle. The parking brake lever is located behind the gearshift lever. To apply the parking brake, pull the lever up fully. The indicator light on the instrument panel will go 'ON'. To release it, pull the lever up slightly, press the release button and push the lever down. The

parking brake indicator on the instrument panel will go 'OFF' when the parking brake lever is fully released.

NOTICE

- Apply the parking brake properly before leaving the vehicle & release it before moving.
- Use the parking brake for holding the vehicle on a down gradient and put vehicle in reverse gear.
- Use the parking brake for holding the vehicle on a up gradient and put vehicle in 1st gear.

ANTI THEFT/ IMMOBILISER AND KEYLESS ENTRY SYSTEM

Anti Theft/ Immobiliser and Keyless Entry System :

This system is essentially an anti-theft security system, which has a keyless operation for door unlock/ lock. It immobilizes the vehicle by disabling starter motor, ignition and fuel supply in case of unauthorised entry.

The system consists of following :

1. One User "Remote" with **LOCK** and **UNLOCK** button for normal use.
2. Body Control Module.
3. "**Lock Indicator Warning**" on dashboard for indication of "mode" of the system.

Features :

- Locking/ unlocking the vehicle from distant place. (Refer arm mode)

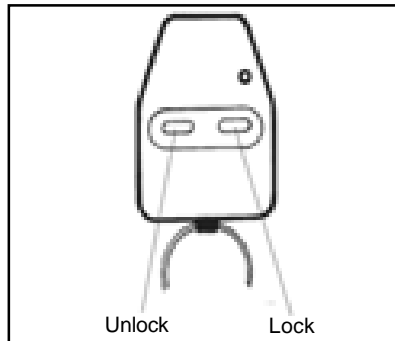

- Immobilisation of vehicle & continuous flashing of turn indicators, if theft is detected (Refer Armed Panic).
- Protection when user forgets to lock using remote.(Refer Auto Arm Mode).
- Immobilisation of vehicle if theft is detected in Auto Arm mode. (Refer Auto Arm immobilised)
- Finding the vehicle. (Refer vehicle seek).
- Manual central door locking/ unlocking (Refer central door locking feature).
- Continuous flashing of turn indicators in case of emergency. (Refer Forced Panic).
- Auto lock and unlock (Refer Auto lock and unlock).

ANTI THEFT/ IMMOBILISER AND KEYLESS ENTRY SYSTEM (IF FITTED)

- Additional/ new remote can be added. Stolen remote can be disabled. (Refer Learning Additional Remote/Unlearning Lost Remote).

DESCRIPTION OF MODES AND USAGE OF "REMOTE" ARM MODE:

Used to lock the vehicle from Distant place (Do not use Mech. Key). Press "LOCK" on User Remote.

- Gives single flash. Locks all doors. Gives delayed flash through turn indicators after locking.
- Lock Indicator on dashboard starts blinking (typically once in 1.5 sec.)
The vehicle arms (i.e. Vehicle cannot be driven. If attempted, the system goes to Armed Panic Mode). Press UNLOCK to disarm the vehicle.
- If any of the doors, bonnet or hatchback is not properly closed before locking, system goes to Armed Panic mode. Press UNLOCK to disarm the vehicle.

Modes of the system :

State of Immobiliser	Meaning / Function of the state
Disarmed	Vehicle can be driven
Armed	Vehicle cannot be driven. Immobiliser is sensing for unauthorised entry.
Armed Panic/ Immobilised	Vehicle cannot be driven. Fuel, ignition, starter supply is cut.
Auto Armed	Vehicle cannot be driven.
Immobilised Auto Armed	Fuel, ignition, starter supply is cut. (Immobiliser is sensing for unauthorised entry.)

ANTI THEFT / IMMOBILISER AND KEYLESS ENTRY SYSTEM (IF FITTED)

UNLOCK/ DISARM MODE :

Used to UNLOCK the vehicle from Distant Place. (Do not use Mechanical Key)

Press 'UNLOCK' on User Remote.

- Gives one flash on turn indicators.
- Unlocks drivers door (Press 'UNLOCK' again to unlock other doors.
- Lock Indicator on dashboard stops blinking.
- The vehicle disarms (User can drive the vehicle).

When Lock Indicator on dashboard is blinking the vehicle cannot be driven. Press UNLOCK to disarm the vehicle.

ARMED PANIC MODE :

In Armed Mode, if Theft is detected (door opened/Key inserted in ignition switch/cranking attempted) vehicle immobilises, hoofing and flashes of turn indicators for about 25 to 30 seconds (To stop the flashing press any button on the user Remote). To mobilise the vehicle press UNLOCK once again.

AUTO ARM MODE :

Protection when user forgets to lock the vehicle using remote.

- In Unlock mode, after the key is taken out of the Ignition switch and leaving the vehicle (door is opened and closed), vehicle arms automatically in 55 sec. (i.e. Vehicle cannot be driven without pressing UNLOCK button on the User remote. If attempted, vehicle goes to auto armed immobilised mode)

- As an additional security measure, the system has a backup facility. In Unlock mode after taking the key out of Ignition switch, the vehicle arms automatically in 55 sec., even if no door activity is detected.
- The Lock Indicator on the dashboard starts blinking once in 1.5 seconds.

When Lock Indicator on dashboard is blinking, the vehicle cannot be driven. Press UNLOCK to disarm the vehicle.

AUTO ARMED IMMOBILISED MODE :

In Auto Armed Mode if Theft is detected (Key inserted in ignition switch/or attempt to crank)

Lock Indicator on the dashboard starts blinking at faster rate and the vehicle immobilises. When Lock Indicator on dashboard is blinking

ANTI THEFT / IMMOBILISER AND KEYLESS ENTRY SYSTEM (IF FITTED)

the vehicle cannot be driven. Press unlock to disarm the vehicle.

CAR SEEK :

It is used to find the vehicle. Press 'LOCK' on User Remote when the vehicle is locked. (Operating Range 7.5 meters)

- Gives three flashes on turn indicators and remains armed.

CENTRAL DOOR LOCKING FEATURE :

All doors can be locked/unlocked by manually locking/ unlocking the driver's door (using mechanical key/knob)

FORCED PANIC MODE :

- Press 'LOCK' and 'UNLOCK' on User Remote simultaneously.
- Turn indicator lamps start flashing continuously.

Press any button on the remote to stop flashing.

AUTO LOCK AND UNLOCK :

(If fitted)

(When driving the vehicle)

1. Whenever vehicle is cranked and engine is fired, all doors will lock automatically after 5 sec., if all doors are closed. If any one of the doors is open, then locking will not take place.
2. After the key is taken out from the Ignition switch, the system automatically unlocks the driver's door.

ANTI THEFT / IMMOBILISER AND KEYLESS ENTRY SYSTEM (IF FITTED)

EMERGENCY DISARMING PROCEDURE :

This procedure is applicable in case of lost remote & system in armed / Auto armed / immobilised state i.e. cluster led is blinking

1. Enter the vehicle by opening the door through physical key & close the door.

In case the vehicle is in armed condition, the system will enter armed panic in immobilised state-will hoot (if provided) and flash for 30 seconds.

2. Open driver door or turn on hazard switch.
3. Turn ignition 'ON' and 'OFF' 3 times within 5 seconds.
4. If step 3 is not completed within 5 seconds the system will remain in immobilised state and the cluster LED will continue flashing.

5. On successful completion of step 3, the system will come out of the immobilised state to enter emergency disarming state. (This state is similar to the immobilised state without the hooting and side indicator flashing).

The cluster LED will stop flashing and remain 'OFF' for 5 seconds.

6. After step 5 the LED starts flashing (0.5 second ON, 0.5 second OFF) for maximum 9 counts the user.

Must count the number of LED flashes and turn ignition 'ON' as soon as this count matches the first digit of secret code (default secret code 3333). The LED will stop flashing.

7. Switch 'OFF' the ignition.

8. The user must enter the 2nd, 3rd and 4th digit of the secret code in a similar fashion as described in step 6 & 7 above.

9. After successful entry of all the four digits of secret codes the cluster LED stops flashing. The system will dis-armed and vehicle will get mobilised.

10. Close driver door or turn 'OFF' hazard switch.

11. In case of any error in entering the secret code digits the LED continuous to flash and the system remains in immobilised state to re-enter secret code (default secret code 3333). Perform step 10 and start the procedure from step 2 onwards.

12. All previously learned remotes will get unlearnt.

13. Vehicle engine is released for 5 cranks (configurable) only.

ANTI THEFT / IMMOBILISER AND KEYLESS ENTRY SYSTEM (IF FITTED)

14. The vehicle can be cranked and driven.

LEARNING OF NEW REMOTE :

This procedure is applicable in case of lost remote and system in armed / auto armed / immobilised state i.e. cluster LED is blinking.

Step 1-12 mentioned above, should be completed successfully and then follow steps 1,2 below, within 30 sec. (Configurable)

1. Open driver door (OR turn 'ON' hazard switch).
2. Turn ignition 'ON' & 'OFF' 5 times within 10 sec.
3. The system enters the learn mode. The LED on instrument cluster will remain ON for 5 sec. (Configurable)
4. Press any key on the remote once within 5 sec.

5. On successful learning of the remote, system gives single hoot with flash.
6. Repeat step 4 & 5 above for learning other remote (Maximum 4 remotes)
7. Learning mode will be exited in 5 seconds, if any of the remotes is not learnt during this time. The learning process has to be repeated.

CHANGING OF SECRET CODE:

This procedure is applicable in case when the user wants to change the secret code

Changing of the code will be possible when the cluster LED is blinking

1. Enter the vehicle by opening the door through physical key, close the door.

In case the vehicle is in armed condition, the system will enter

armed panic - will hoot (if provided) & flash for 30 seconds.

2. Switch 'ON' the parking lights.
3. Turn ignition 'ON' and 'OFF' 3 times within 5 sec.
4. If step 3 is not completed within 5 sec. the system will remain in immobilised state and the cluster LED will continue flashing.
5. On successful completion of step 3, the system will come out of the immobilised state and the procedure for entering new secret number can be started (This state is similar to the immobilised state without the hooting and side indicators flashing)
6. The LED starts flashing (0.5 sec. ON / 0.5 sec. OFF) for max. 9 counts.

ANTI THEFT / IMMOBILISER AND KEYLESS ENTRY SYSTEM (IF FITTED)

7. The user has to enter the existing secret number. The user must count number of LED flashes and turn the ignition switch ON as soon as the count matches the "1st" digit of the existing secret code. The LED will now stop flashing.
8. Switch OFF the ignition.
9. The user must enter the 2nd, 3rd and 4th digit of secret code in similar fashion as described in step 6,7 and 8 above.
10. After successful entry of all the 4 digits of existing secret code, the cluster LED stops flashing for 10 sec.
11. If a wrong secret code is entered, the LED continues to flash and the system remains in immobilised state. To reenter secret code, switch OFF the parking lights and start procedure from step 2 onwards.
12. Repeat steps 7, 8 and 9 but with the new 4 digit number. The digits to be entered can be from 1 to 9. After successful entry of all 4 digits of new secret codes the cluster LED stops flashing for 10 sec.
13. Again repeat the steps 7, 8 and 9 with the same new 4 digit number. After successful entry of all the 4 digits of new secret code, the cluster LED stops flashing for 10 sec.
14. If the new secret code entered twice is not matching then the flashing of side indicators will start for 5 sec. To restart the procedure of entering new code, steps from 12 onwards to be performed. Cluster LED starts flashing after 10 sec.
15. If secret code entered twice is matching then the system gives information of newly entered code with the equivalent number of LED flashes for each digit, with a 5 sec. gap between 2 digits.
16. Switch OFF the parking lights.
17. The newly entered secret number to be used here after emergency dis-arming and remote learning.

NOTICE

No remote will get unlearnt with this procedure. During this procedure any key pressed from the remote will be ignored.

ANTI THEFT / IMMOBILISER AND KEYLESS ENTRY SYSTEM (IF FITTED)

Remote - Battery Replacement

(replace every year for normal use)

1. Place the remote button-side facing down and remove screws.
2. Change the battery with GOLDEN POWER Battery GP 23A or equivalent (eg:- Duracell MS21/MN21).
3. Put back the screws.
4. Press any button and check that the LED on the remote glows.
5. Change the default PIN number using above procedure.

GUIDELINES FOR USER :

- **The vehicle does not start (Engine does not crank/fire)**

Check the Lock Indicator on the dashboard. If it is blinking then the vehicle is not supposed to start (Arm Mode/Auto Arm

Mode). Press UNLOCK button on the User Remote and then start the vehicle.

If the turn indicators are blinking, pressing the UNLOCK button of the User Remote will stop the blinking of the lamps. The next pressing of the UNLOCK button of the User Remote will unlock/disarm the vehicle and then the vehicle can be driven. Contact the dealer if the vehicle still could not be started.

- **Pressing UNLOCK/LOCK does not UNLOCK/LOCK the vehicle.**

If the turn indicators are blinking, pressing UNLOCK/ LOCK will stop the blinking of lamps. The next UNLOCK/ LOCK press will actually unlock/disarm the vehicle and the vehicle can be driven.

- **Battery Low Indication :**

1. Operating Distance has come down
 2. LED on user remote flashes whenever UNLOCK/ LOCK button is pressed on the remote (under normal battery conditions, the LED on the user remote lights continuously whenever UNLOCK / LOCK button is pressed).
 3. Replace the battery to get increased range.
- Press any of keys on remote, if LED of the remote is continuously 'ON', means battery is OK. If it is blinking, then remote battery is to be replaced.

NOTICE

Remote may not be operative in near transmission vicinity of high power antenna (like TV).

Getting Started

KEYS & DOOR LOCK

Keys:

The key operates all locks and Ignition switch.

A code number is stamped on the plate attached to the key set. Detach this plate and store at safe place (Not in the vehicle). This reference number is necessary while getting duplicate keys from your Authorised Dealer. It advisable to keep another key at safe place for use in case of emergency.

NOTICE

Do not use locally made keys, get a duplicate key through your authorized dealer.

Front Doors (Driver & Co-driver)

Locking / unlocking doors with key from outside :

Both front doors (drivers & co-driver) have separate locking facility. Front doors can be locked or unlocked from outside with key.

Insert the key and turn it anti-clockwise (A) to open or clockwise (B) to lock the door. Pull the Door handle to open an unlocked door.

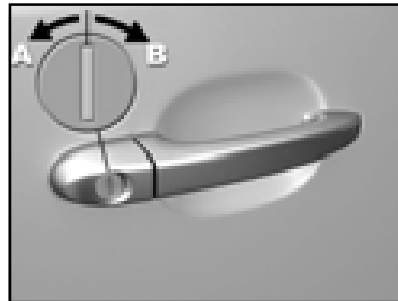

Locking without a key from inside:

All the doors can also be locked or unlocked independently from inside by pressing or pulling the knob.

WARNING

When locking doors this way, do not leave the key inside the vehicle.

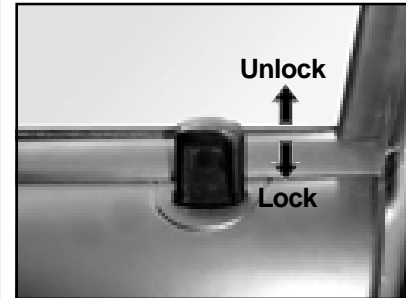

DOOR LOCK & CHILD LOCK

Opening The Doors From Inside :

All doors can be opened from inside. To open pull the door opening lever / latch.

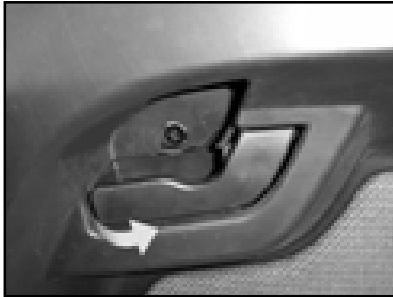

Location of door opening lever / latch

Childproof Lock :

Both the rear doors on dual cab model are provided with child proof lock. Push the lock lever located on vertical face near the lock upward before closing the door. The door which has been locked cannot be opened from inside, it can be opened only from the outside.

⚠ CAUTION

Deactivate the childproof lock when not required.

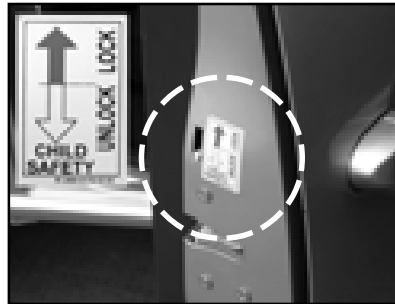
**Tail Gate Locking / Unlocking:**

To open the tail gate pull the swing handle outwards, and just by closing the tail gate to its original position, it gets self locks.



Tail Gate Swing Handle

SEAT, SEAT ADJUSTMENTS & SEAT BELTS

Seats :

Bucket type seats are provided with a position lever, lumbar support and recliner handle knob.



1. **Lever for Seat Movement (Forward & backward)**
2. **Seat Back Recliner and seat position lever.**
3. **Lumbar Support Adjustment Lever**

1. Seat Back Recliner and seat position lever : To change the seat back angle, lean forward slightly and raise the lever (1). Then lean back to the position you want and release it.

2. Moving the Seat Forward & Backward:

To adjust the seat position, lift the lever (2) then slide the seat to the desired position and release the lever. Make sure the seat is locked in position.

3. Lumbar Support Adjustment:

Use the lumbar operating handle (3) to increase or decrease support to the lumbar region of the back to give a fatigue free seating position, especially on long journey.

Head Restraint :

Adjustable head restraints are provided for bucket seats in front. Neck rest for rear bench seat (Dual Cab) cannot be adjusted. To increase the height lift up and leave at desired click position. To reduce the height, press the unlock button & push the head restraint downwards.

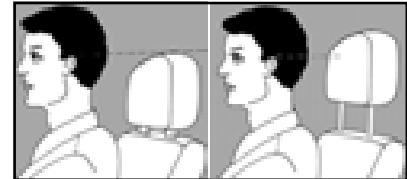

Poor Adjustment

Good Adjustment

Seat belt

It is a mandatory requirement that seat belts be used and correctly adjusted. It is strongly advised that driver and all passengers wear seat belts, while traveling. Belts are designed to afford a substantial measure of restraint to the wearer in certain common accident and other driving situations. Your vehicle is equipped with inertia reel, lap/sash seat belts for all occupants. It is recommended that you carefully follow instructions given below :

CAUTION

When using seat belts, observe the following :

- Use belt for only one person at a time. Do not use a single belt for two or more people - even children.

- It is dangerous to put a belt around a child being carried on occupants lap.
- After inserting the tab, make sure that the connection is secure and belt strap is not twisted.
- Be careful not to damage belt webbing or hardware, and take care that they do not get caught or pinched in the seat or doors.
- Inspect belt system periodically. Check for cuts, frays, and loose parts. Damaged parts should be replaced.
- Keep belts clean and dry. If they need cleaning, use a mild soap solution or lukewarm water. Never use bleach, dye, or abrasive cleaners — they may severely weaken belts.

- Replace belt assembly if it has been used in a severe impact. It should be replaced even if damage is not visible.

Seat belts fastening

To put seat belt on, grasp the tongue and move it across your body until it can be engaged with the buckle. Push the tongue into the buckle until a positive “click” is heard.



Fastening of Seat belts

SEAT BELTS

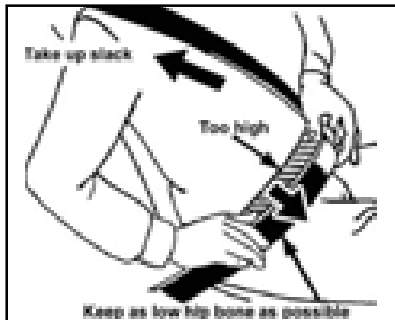

Adjustment of Seat Belts - Lap /

Sash Belts :

After fastening seat belt, remove slackness from lap portion of belt so that it fits snugly, by grasping sash part of the belt and pulling it gently towards your shoulder. Inertia reel will then take up the slack, allowing sash section to fit correctly against your upper body. Inertia reel allows freedom of normal movement to reach forward or across the vehicle but will lock

when webbing is tugged very quickly, or with any rapid change in vehicle motion, such as moderately hard braking.

Unfastening Seat Belts :

To unfasten belt, press release button marked "PRESS" located on the buckle, and tongue will be released.



Unfastening of Seat belts

Seat-belt Adjusting Knob : To adjust the Seat belt pull the knob and slide it vertically.

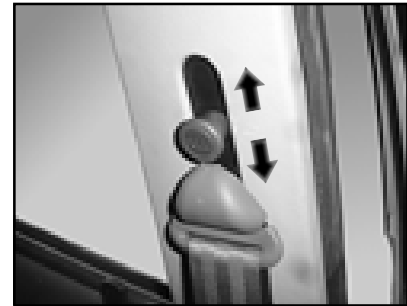

Seat-belt Precautions for Baby, Small Child & Pregnant Woman :

TATA MOTORS strongly urges that the driver and passengers in the vehicle be properly restrained at all times with the seat-belts. Failure to do so could increase the chance of injury and / or the severity of injury in accidents.

Baby or Small Child :

Use child restraint system appropriate for the child until the child becomes large enough to properly wear the vehicle's seat-belts.

If a child is too large for a child restraint system, the child should sit in the seat and must be restrained using the vehicle's seat-belt.

Also use the seat-belt while the child is in the middle seat. According to accident statistics, the child is safer when properly restrained in the rear seat than in the front seat. Child restraint systems are available. **TATA MOTORS** recommend the use of a type which fits to your vehicle. Before installation, always read the manufacturer's instructions.

Do Not install a rearward facing child seat in the front passenger seat if a front passenger airbag is fitted. An inflating airbag could impact with the seat causing serious injury, or even death for the child.

Pregnant Woman :

TATA MOTORS recommends the use of a seat-belt. Ask your doctor for specific recommendations. The lap belt should be worn securely and as low as possible over the hips and not to waist.

WARNING

- Seat belts are designed to bear upon bony structure of the body, and should be worn low across the front of pelvis or the pelvis, chest and shoulders, as applicable; wearing the lap section of the belt across the abdominal area must be avoided.

WARNING

- Seat belts should be adjusted as firmly as possible, consistent with comfort, to provide protection for which they have been designed. A slack belt will greatly reduce the protection afforded to the wearer.
- Care should be taken to avoid contamination of the webbing with polishes, oils and chemicals and particularly battery acid. Cleaning may safely be carried out using mild soap and water. The belt should be replaced if webbing becomes frayed, contaminated or damaged.
- It is essential to replace the entire assembly after it has been worn in a severe impact even if damage to the assembly is not obvious.

STEERING WHEEL ADJUSTMENT

WARNING

- Belts should not be worn with straps twisted.
- Each belt assembly must only be used by one occupant; it is dangerous to put a belt around a child being carried on the occupant's lap.

WARNING

- No modifications or additions should be made by the user which will either prevent the seat belt adjusting devices from operating to remove slack, or prevent the seat belt assembly from being adjusted to remove slack.

Steering Wheel Position Adjustment :

You can adjust the steering wheel to suit your driving position. Adjust the steering wheel position as follows before you start driving.



- Adjust the seat to a comfortable position.
- The lever to tilt the steering wheel is located under steering column. Pull the lever down and hold in that position.

- Move the steering wheel up or down to the desired position. Position the wheel in such a way that all the instrument panel gauges and warning lights are visible.
- Release the lever & keep the lever in up position. Make sure that steering wheel is securely locked by moving up and down.

CHECKS BEFORE DRIVING

Before Driving, please ensure to Check : (Refer maintenance Section)

1. Tyre pressure
2. Coolant level
3. Engine oil level
4. Brake fluid level
5. Clutch fluid level
6. Water in windshield washer reservoir
7. Power steering oil level
8. Battery electrolyte level
9. Fuel level

Adjust

1. Front seat
2. Rear view mirrors

Ensure

1. Bonnet is properly closed.
2. All doors are properly closed.
3. Seat belts are fastened.

4. All switches & lamps are working.
5. Gear shift lever is in neutral position.
6. Parking brake is released.

Preparing to Drive

The following checks and adjustments should be done before you start driving the vehicle.

- Ensure all mirrors, windows and outside lights are clean and unobstructed. Remove dust, frost, snow or ice if any, on these.
- Check that any items you may be carrying inside with you are stored properly or fastened down securely.
- Check adjustment of steering wheel. (Refer getting started section)

- If the doors are not properly closed you will get a audio warning/indicator light as soon as you insert the ignition key in the switch. Make sure all doors are properly closed and locked.
- If the seat belts of driver & co-driver are not fastened you will get an audio warning / Indicator light as soon as you turn the key to ignition position. Fasten your seat belt ensure co-driver and passenger seats have also fastened the seat belt.
- Check and ensure that all the gauges and indicator lights in the instrument panel are working.

SAFETY CHECKS

Windshield Washer :

Always keep windshield glass clean to avoid any distraction in visibility. Ensure proper working of wipers and condition of wiper blade. Ensure that windshield washer reservoir is full. Do not operate wiper alone when the windshield glass is dry this would damage the windshield.

Headlights :

Keep headlight lenses clean. Check for operation of headlamps in both high/low beam condition. Check for correct focusing of headlamps. Use only recommended type bulbs. Use with care the high beam as its glare may dazzle the driver of the oncoming vehicle, the condition could cause an accident.

Side Indicators / Hazard

Warning :

Ensure that all side indicators/hazard warning lights are always in working condition and they are used when required.

Horn :

Ensure the horn is working properly. Horn provides safety to other road users by alerting your presence.

Brakes :

Ensure brakes are working properly. Check brake fluid level in reservoir. Do not drive the car when brake warning lamp is 'ON'.

Tyres :

Check the condition of tyres for any abnormalities. Maintain correct tyre pressure, it is very important particularly when subjected to extreme condition, such as high speed, high load and high outside temperature. Do not use worn or bald tyres on the front wheels.

First Aid Kit :

First aid kit is provided in your vehicle. This is for use in case of minor injuries. It is to be regularly checked for any disintegration and should be updated regularly.

Seat Belt :

Seat-belts are life saving equipment, use of seat-belts reduces the chance of injury and severity of injury in case of an accident. It is strongly recommended that all vehicle occupants should always wear seat-belts, while vehicle is in motion.

Influence of Vehicle Alcohol :

Avoid driving under the influences of alcohol or drugs. Alcohol and drugs will severely impair your control of the vehicle and increase the risk of injury to yourself and others.

Mobile Phones :

Avoid using mobile phones while driving your vehicle. This could divert your attention from the road and result in an accident.

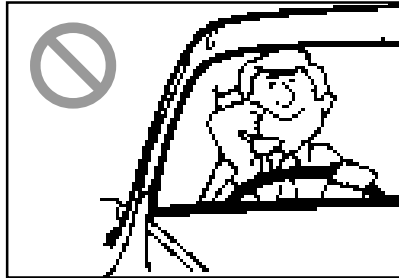
**Fatigue 'Rest Revive Survive' :**

Do not attempt driving when you feel tired. Long distance driving can tire you and fatigue can dull your reflexes and judgment. This can be avoided by taking breaks at regular two hourly intervals.

FUEL SAVING TIPS

INSTRUCTIONS TO IMPROVE FUEL ECONOMY :

Your vehicle's fuel economy is mainly dependent on your style of driving.

To operate your vehicle as economically as possible, use the following driving suggestions.

Avoid Excessive Idling :

Stop the engine and start it again, if you have to wait for more than a minute while you are stopped.

Avoid Fast Starts and Unnecessary Stops :

Start off slowly from traffic lights or stop signs to prevent increased fuel consumption and shortening of engine life. Avoid unnecessary deceleration (stopping or slowing down) and then accelerating which uses more fuel.

Always Maintain a Clean Engine Air-Filter :

The amount of air supplied will reduce due to clogged air-filter, resulting in wastage of fuel due to incomplete combustion.

Avoid Incorrect Tyre Pressures :

Under-inflated tyres result in increased running resistance of the tyres, leading to wastage of fuel. (Refer tyre maintenance section)

Proper Driving Practices :

Keep a safe distance from other vehicles to avoid braking suddenly.

Fuel Economy Speeds :

Gear	Speed (kmph)
1st	15
2nd	30
3rd	45
4th	60
5th	80

NOTICE

Do not rest your foot on the clutch pedal. It does not allow full engine power to be transmitted to the vehicle and reduces clutch life.

STARTING, STOPPING THE ENGINE

Starting The Engine :

Before starting

1. Apply parking brake.
2. Ensure gear lever is in neutral.
- A. Insert the key in steering and ignition lock and turn it to 'ON' position.
- B. Press the clutch pedal fully.
- C. Now crank the engine.
- D. If the engine does not start turn the key to off position and try after 30 seconds.

NOTICE

After starting run the engine in idle speed for at least 30 seconds. Do not press accelerator pedal while starting the engine to avoid damage to turbocharger.

Stopping The Engine :

Before switching off the engine, run the engine in idle condition for atleast 30 seconds and then switch off. This will allow the engine oil to lubricate the turbocharger, till its speed is fully reduced and also allow the unit to cool down.

Above precautions will ensure a longer life and performance from the turbocharger.

Running-in Period :

Avoid rapid acceleration and prolonged high speed running of the engine while using the new vehicle for the first 1500-1800 km of operation.

Do not exceed the following vehicle speed during running in period.

Gear Box :

Gear	2H/4H	4L
	km/hr	km/hr
1st	20	8
2nd	40	16
3rd	65	26
4th	95(90)*	38(36)*
5th	110	44

Gear box has all synchromesh gears including reverse. The 5th gear is an over drive.

When shifting the gear up or down make sure you press the clutch pedal fully and shift to the next gear and then release the clutch pedal gradually.

STARTING, STOPPING THE ENGINE

Before shifting in to reverse gear bring your vehicle to a complete stop and depress the clutch pedal fully.

Do not shift into reverse gear with vehicle moving forward.

While changing gear it is recommended to shift at the speeds given in the table.

You can get extra braking from the engine when slowing down by changing to a lower gear.

This can help you to maintain a safe speed and prevent your brakes from overheating while going down a steep hill.

 **CAUTION**

Avoid excessive revving up of engine rpm.

 **CAUTION**

Running Engine under idle condition for long duration and also in high idle (fly-up rpm) should be avoided

Gear Shifting :

Gear Change Speeds During Upshift :

Gear	Vehicle Speed during up shift	
	2H/4H	4L
	km/hr	km/hr
1-2	25	10
2-3	45	18
3-4	75	30
4-5	100	40

Gear Change Speeds During Downshift :

Gear	Vehicle Speed during down shift	
	2H/4H	4L
	km/hr	km/hr
2-1	15	6
3-2	25	10
4-3	45	18
5-4	65 (60)*	26 (24)*

2H - Rear wheel drive

4H - Four wheel drive (High)

4L - Four wheel drive (Low)

Transfer Case (for 4 x 4 vehicles)

Transfer case allows driver to select 2 or 4 wheel drive operation.

Your vehicle is fitted with 2 speed, part time electric transfer case.

Transfer Case Selector Switch :

This switch is electrically operated & mounted on dash board, and is provided with 3 selector positions.

2H- Only rear wheels are driven and transfer case operates at 1:1 ratio.

4H- All four wheels are driven and transfer case operates at 1:1 ratio.

4L- All four wheels are driven and transfer case operates at 2.48:1 speed reduction ratio.



Automatic Hub Lock :

When 4 wheel drive is selected, automatic hub locks axle shaft to wheel hub. This occurs when the vehicle driven in either forward or reverse direction.

Limited Slip Differential :

(4x4 version only)

A standard differential delivers torque equally to each wheel. In case one wheel loses traction and begins to spin, the differential distributes rotary speed unequally

but with same torque. This can cause wheel with good traction to slow down or stop while the wheel which lost traction rotates with increased speed. Such a situation can prevent the vehicle from moving. Limited slip differential provided in the rear axle takes care of such situations. However during normal driving, differential action takes place in the same manner as in a standard differential.

1. Four Wheel Drive Operation

In 2-H mode, only the rear two wheels of the vehicle are powered by the engine and the front wheels are merely pushed. By shifting to four wheel drive mode (4H or 4L) the rear as well as the front axles are driven by the engine through the transfer case and transmitting engine power to all four wheels. This gives the vehicle increased traction. In 4H mode, the

GEAR SHIFTING (4X4)

transmitted engine torque and vehicle speed remain the same as in 2H. However, when you shift to 4L mode, engine torque is multiplied and vehicle moves at low speed in the same gears with increased traction. 4L mode is provided for negotiating sharp gradients or driving through loose soil/sand.

2. Shifting from 2H to 4H :

Shift selector switch mode from 2H to 4H. 4WD HI indicator will turn ON.

Shifting is possible during driving.

3. Shifting from 4H to 2H :

Shift selector switch mode from 4H to 2H. 4WD HI indicator light will turn OFF.

Shifting is possible during driving.

Free Wheeling of Front Hub :

After shifting from 4H to 2H, for effecting free wheeling of front wheels, direction of vehicle motion needs to be changed. If in 4H mode the vehicle was moving forward then stop it, wait and then engage reverse gear. (If it was moving reverse in 4H mode then stop it, wait and then engage forward gear of main gear box.) After stopping and changing the gear the vehicle must travel in opposite direction for a minimum of three meters, for free wheeling.

4. Shifting from 4H to 4L

- Stop the vehicle in safe area.
- Press clutch pedal.
- Shift selector switch mode from 4H to 4L. 4WD LO indicator light will turn ON.

5. Shifting from 4L to 4H

- Stop the vehicle
- Press clutch pedal
- Shift selector switch mode from 4L to 4H. 4WD HI indicator light will turn ON.

CAUTION

Do not exceed the following speeds :

4H (4WD High Range) 100 km/ h.

4L (4WD Low Range) 40 Km/ h.

CAUTION

In case of malfunctioning in shifting from 4H to 4L or 4L to 4H, respectively 4L or 4H light will flash continuously. Do not march the vehicle in such cases.

NOTICE

Four wheel drive facility is a powerful tool which enables the vehicle to traverse terrain which is otherwise inaccessible to two wheel drive vehicles. However, it must be used judiciously and carefully. Do not take unnecessary risks and attempt the impossible. Familiarise yourself thoroughly with the vehicle and its abilities before attempting serious off road driving.

WARNING

- Do not use 4H or 4L modes continuously on dry and hard surfaced road except for checking operation. It can cause extensive damage to transmission & tyres.
- With ignition 'ON' 4H & 4L indicator lamp on panel should glow for a few seconds only and then go off. Continuous illumination of 4L & 4H lamps indicates a fault in transfer case or in its electrical circuit.

BRAKING

Brakes :

The brake system on this vehicle is an advanced vacuum assisted hydraulic brake system, equipped with:

- Brake booster : This assists the driver in braking with an ergonomic pedal force on brake pedal;
- Tandem Master Cylinder, for fail safe braking.
- Twin pot calipers, for efficient energy absorption.
- LCRV - Load Conscious Reducing Valve, to avoid rear wheel locking in extreme load condition.
- Auto adjusted rear brakes which are designed for trouble free performance.

The system is designed with an H circuit, this has an advantage of providing minimum braking even if one circuit fails, however the pedal

will be harder to press and stopping distance will increase. At the same time brake indication light would glow on dash board.

If you observe any abnormality with the in brake system contact your nearest TATA Motors authorized workshop.

In case of failure of vacuum supply to the brake booster the vehicle can still be stopped with a higher pedal effort. In case of vacuum failure or brake circuit failure, slow down the vehicle by shifting to a lower gear and lifting your foot from the accelerator pedal. Pull to the side of the road as soon as it is safe.

CAUTION

Brake system failure is very hazardous. It is best to have your vehicle towed, but if you drive the vehicle in this condition, be extremely cautious.

Have your vehicle attended to immediately.

Put your foot on brake pedal to apply brake. But do not ride the brakes as they may overheat and reduce efficiency and performance may be impaired. The brake lights may confuse the other road users behind you.

Use the engine to assist the brakes by shifting to a lower gear and lifting your foot from accelerator pedal.

Constant application of brakes while going down hill builds heat and reduces braking efficiency.

Check your brakes after driving through deep water. Apply the brakes moderately to feel if they are normal. If not, apply them gently and frequently until they do. With wet brakes you should be extra cautious and alert in your driving.

DRIVING IN ADVERSE CONDITIONS

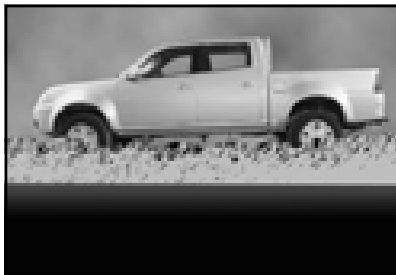
Driving Through Water :

Never venture to drive through water when it flows over guard rails. The engine may be seriously damaged, if attempting a deep water crossing.

If the situation demands that you have to drive through water then;

- Keep engine in fast idling and crawl the vehicle in low gear.
- After driving through water apply brakes several times to dry liners and to regain original braking.

Do not attempt to start the engine if vehicle gets flooded due to water increase.

Tow the vehicle to a safe place.

Take the vehicle to nearest **AUTHORISED** Workshop to check for the entry of water into the cylinders.

It will also be necessary to replace the lubricants of engine, gearbox, transfer case, front axle and rear axle if water has entered.

Get the starter and alternator checked.

Driving on a Rainy Day :

Check brakes, steering and windows.

Check tyres for wear and tyre pressure.

Check wiper blades for proper functioning.

Avoid harsh braking and sharp turns. It may cause loss of control and lead to skidding.

For slowing down, change to a lower gear and brake gently.

Keep lights **ON** if visibility is poor.

Night Driving :

Dip the head lamps for oncoming traffic during night driving.

Maintain a speed such that you can stop within illuminated distance of head lamps.

DRIVING IN ADVERSE CONDITIONS

Use side indicators for lane change or turning.

- Put on the hazard warning switch in cases of hazardous parking or if your vehicle is disabled to warn the passing traffic.

Climbing Sharp Gradients on Loose Surfaces :

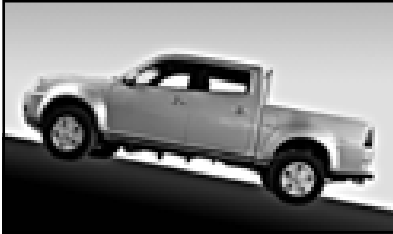

Select gear to suit gradient gear. Apply power smoothly so that there is no loss of traction by over-revving of the engine.

Choose the smoothest as possible part of the slope and select the appropriate gear so that gear

changing in the middle of the climb is not required.

Changing gears in the middle of the climb can cause loss of momentum and engine stalling. Shifting to lower gear has to be done cautiously to avoid loss of traction.

Under no conditions should the vehicle be moved diagonally across a hill. The danger is in loss of traction and sideways slippage, possibly resulting in tipping over. If unavoidable, choose as mild an angle as possible and keep the vehicle moving.

If the wheels start to slip within few feet of the end of the climb, motion can be maintained by swinging the steered wheels left and right, thereby providing increased grip.

If the vehicle stalls or losses headway while climbing a steep hill, make a quick shift to reverse

and allow the vehicle to move back with the control of engine compression.

Descending Sharp Gradients :

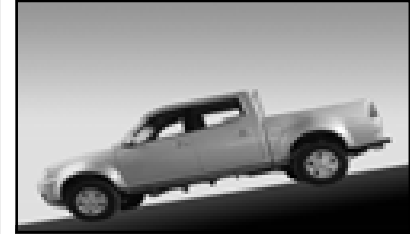

Depending on the severity of the gradient, shift into appropriate gear. Use engine braking judiciously without over-revving the engine.

Brake application under such situations should be done very smoothly to avoid loss of control. Select appropriate gear so that gear changing or clutch disengagement is not involved while descending the gradient.

JACK LOCATION, WARNING TRIANGLE & FLAT TYRE REPLACEMENT

Advance Warning Triangle :

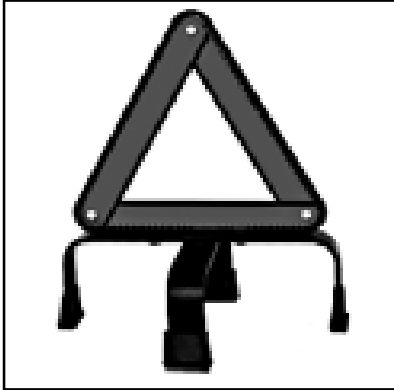

There is an advanced warning triangle provided with your vehicle. In case there is a breakdown and the vehicle is parked at the side of the road, then the triangle is to be used as per instructions given below:

- 1) Remove advance warning triangle from case and assemble.

- 2) Place the triangle on the road behind the vehicle.
- 3) The triangle must be at least 50 meters behind the vehicle in the same lane of traffic.
- 4) Increase the distance to 150 meters on a highway or if on the crest of a hill where it obscures the view. A bad / hill top obscures the view.

If you have Flat Tyres :

- 1) Reduce vehicle speed gradually keeping it in a straight line. Move cautiously off the road to safe place away from traffic. Park the vehicle on a level and firm ground. Apply parking brake & engage 1st gear.
- 2) Turn on Hazard warning switch. Keep advance-warning triangle at least 50 meters behind the vehicle as an indication of breakdown.



Tool and Jack - Single Cab

1. Jack handle 2. Jack

Incase of Emergency

JACKING POINTS, FLAT TYRES REPLACEMENT

- 3) Take out 'Tool kit & Jack' from vehicle which is kept at the rear of the cab below the rear passenger seat (For crew cab).
- 4) Rotate jack lever and take out jack.

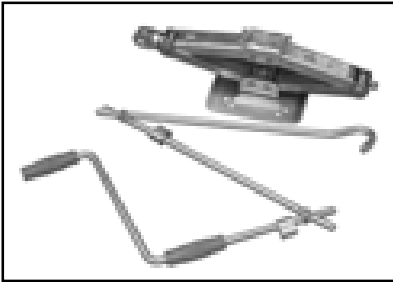

- 5) Spare wheel is located at the rear of the vehicle under the load body.
- 6) Remove the spare wheel-mounting nut. Remove the spare wheel.
- 7) Chock the wheel, which is diagonally opposite to the flat tyre.

- 8) Remove wheel cover (if fitted) and loosen the wheel nuts of flat tyre (Do not remove the nuts at this stage).
- 9) Set the jack properly at correct jacking point as shown and slowly lifting the vehicle with the help of jack handle by turning it clockwise.

CAUTION

- a) Do not lift the vehicle with someone inside or with a load.
- b) Raise the vehicle only high enough to remove and change tyre.
- c) Do not work under the vehicle when only supported by a jack as personnel injury may occur. Use vehicle support stands.
- d) Do not start or run the vehicle while supported by jack.
- e) The jack must be used on firm level ground where possible.

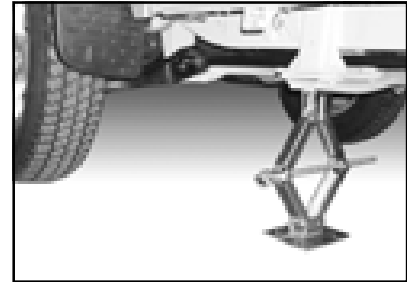

Jack Location at Front

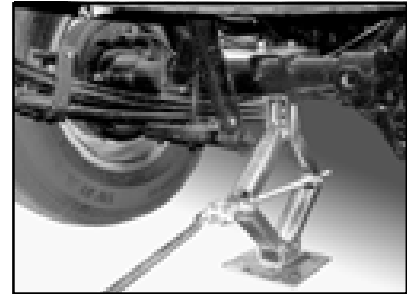

Jack Location at Rear

- 10) Remove wheel-mounting nuts and take out flat tyre.
- 11) Roll the spare wheel into position and align the holes in the wheel with studs. Then reinstall the wheel nuts (taper end inward) and tighten them as much as you can by hand.
- 12) Lower the jack completely then tighten the wheel nuts one by one. Put the wheel cover back.
- 13) Restore all the tools and jack at their respective location.
- 14) Place the flat tyre at spare wheel location and tighten the mounting nuts properly.

⚠ CAUTION

Check tyre pressure and nut tightness of changed wheel at nearest Service station. Also, get the punctured tyre repaired.

Spare Wheel Carrier Removal and Fitment Procedure Removal of Wheel :

- a. Remove the nut which is on the long bolt beneath the wheel rim of the spare wheel.
- b. Insert the spare wheel carrier spanner through the spare wheel access hole on the load body at the rear and locate the shaft of the spare wheel assembly.
- c. Rotate the spare wheel carrier spanner with the help of the wheel spanner in the counter clockwise direction so that the rope unwinds and spare wheel starts coming down.
- d. After the spare wheel touches the ground, rotate further to release the tension in rope and pull the wheel from beneath the

vehicle. e. Remove the holder bracket from the wheel rim, by lowering it and taking it out.

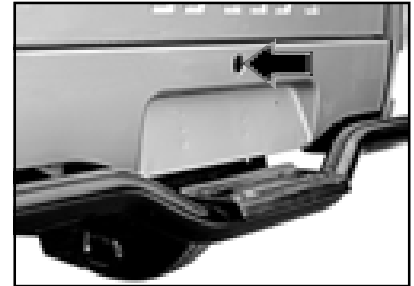

Spare Wheel Access Hole

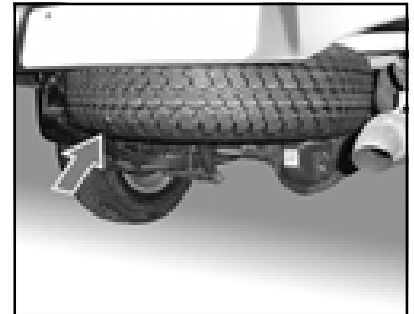

Spare Wheel Location

SPARE WHEEL & LIMP HOME MODE

Fitment of Wheel :

- a. Place the spare wheel beneath the vehicle in such a way that the wheel disc is facing upwards.
- b. Put the holder bracket inside the wheel rim. First locate one lug on the edge of the centre hole of the wheel rim and then locate the other lug in any one of the bolt holes.
- c. Insert the spare wheel carrier spanner through the access hole at the rear of the vehicle and locate the shaft on the winch assembly.
- d. Start rotating the spare wheel carrier spanner, using the wheel spanner in clockwise direction so that the wheel starts moving up.
- e. Adjust the wheel by rotating it by hand slightly so that the

locating bolt goes into one of the holes on the wheel rim.

- f. Tighten the wheel properly, so that it is not moving when pushed by hand.
- g. Put the nut on the long bolt from beneath the wheel rim and tighten it. It is a good practice to tighten the assembly occasionally to remove any loosening of rope which may occur while running the vehicle.

Limp Home Mode :



When water gets accumulated in water sedimenter “water in fuel indicator lamp” on instrument cluster remains ON continuously.

This causes the vehicle to run on “Limp Home Mode”; there is a drastic reduction in performance of the vehicle in Limp Home Mode.

NOTICE

At initial “Key-ON” the water in fuel lamp indication on the dashboard glows for 2 seconds and goes ‘OFF’ automatically. If this lamp does not glow, vehicle has to be taken to the service station for verification and necessary attention.

STARTING THE ENGINE WITH JUMP LEADS

Starting The Engine With Jump Leads :

The engine with a discharged battery may be started by transferring electrical power from a battery in another vehicle.

Due care must be taken as any deviation from the following instructions could lead to personal injury resulting from any battery explosion, as well as damage to the electrical systems in both vehicles.

CAUTION

Do not allow battery electrolyte to come in contact with eyes, skin, fabrics or painted surfaces. The fluid contains sulphuric acid which can cause injury and severe damage. Wear rubber gloves, to avoid risk of contact.

To lessen the risk of injury, wear eye protection when working near any battery.

- Make sure that the battery providing the jump start has the same voltage as the battery in your vehicle (12 V). Its capacity must be approximately the same as the original battery capacity. The voltage and capacity are given on the batteries.
- Do not disconnect the discharged battery from the vehicle.
- Switch off all unnecessary electrical loads.
- Do not lean over the battery during jump starting.
- Do not allow the terminals of one lead to touch those of the other lead.
- Apply the hand brake. Keep the gearshift lever in neutral.
- Do not connect the lead to the negative terminal of the discharged battery.
- The connection of the positive lead should be as far away from the discharged battery as

possible and as close to the starter motor.

- Route the leads so they cannot get caught up with rotating parts in the engine compartment.
- The engine of the vehicle providing the jump start can be allowed to run during starting.

Attempts to start the engine of the vehicle with the discharged battery should be made at intervals of one minute and should not last more than 15 seconds. After starting, allow both engines to idle for approximately 3 minutes with the leads still connected.

Connect Leads In The Order As Shown In The Sketch :

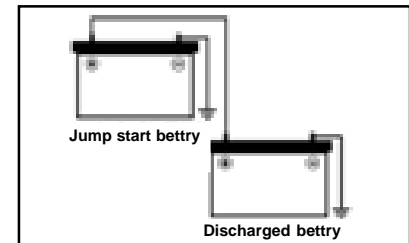

Incase of Emergency

TOWING THE VEHICLE

Towing the Vehicle :

- For towing a vehicle, the best way is to use a towing operator.
- Alternatively use a rigid tow bar.
- Avoid using a flexible cable or rope as your vehicle may crash into the vehicle towing your car when it stops suddenly.
- Switch 'ON' the hazard warning signals of both vehicles to warn other road users.
- Where possible, keep the engine idling so that power steering assistance and brake vacuum are available.
- Limit the speed to 20-30 kmph.
- In case of brake failure, use the parking brake to control the vehicle.

Front and Rear Tow Hook Location :

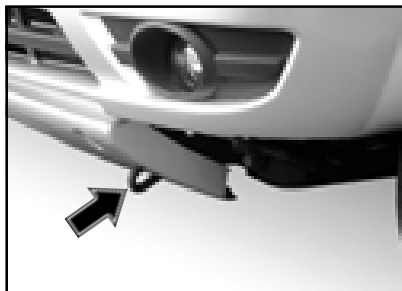

Two Hook Location at Front

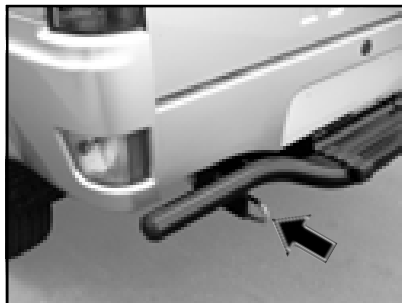

Two Hook Location at Rear

Be extremely careful to prevent injury to yourself and others and damage to your vehicle when using this manual for inspection and maintenance.

The ignition and fuel systems are highly important in view of emission control and for efficient engine operation. Similarly the brake system for safety. Don't tamper with them.

All inspections and adjustments must be made by a qualified technician. We strongly recommend that all servicing related to these systems be done by an authorized Tata dealer.

Owner Maintenance :

Routine Service :

We highly recommend that these items be inspected at least every week.

Engine Oil Level, Engine coolant Level, Brake Fluid Level, Washer Fluid Level, Battery, Tyre inflation pressure.

Do it Yourself :

Improper or incomplete service may result in problems.

Several maintenance procedures can be done only by a qualified service technician with special tools. Improper do it ourself maintenance during the warranty period may affect warranty coverage. If you're unsure about any servicing or maintenance procedure, have it done by an authorized Tata dealer.

WARNING

Maintenance Procedures :

Performing maintenance work on a vehicle can be dangerous. You can be seriously injured while performing some maintenance procedures. If you lack sufficient knowledge and experience or the proper tools and equipment to do the work, have it done by qualified technician.

Preliminary Trouble Shooting

ENGINE

These tips are given for your guidance. Such preliminary jobs are to be carried out in an emergency. In normal cases the problems should be attended to in an authorised Tata workshop by following the repair procedures given in the Workshop Manual.

PROBLEM OBSERVED	PROBABLE CAUSE	ACTION TO BE TAKEN
ENGINE		
1. Engine not cranking	Dead battery, loose or improper battery / electrical connections	<ul style="list-style-type: none">● Get battery checked and / or changed● Jump start using another battery● Clean & tighten connections
2. Engine cranks but does not start	Air in the fuel system	<ul style="list-style-type: none">● Get the air removed by squeezing the primer (pear) pump.● Check leakages
3. Check Engine lamp continue to glow, even after start	Some faults are detected by the ECU.	<ul style="list-style-type: none">● Get the vehicle checked and rectified at Authorised workshop
4. Engine overheats	Coolant level low, coolant leakages Hose collapsed/torn Low engine oil level Cap not sealing properly Engine cooling fans not working Brakes binding	<ul style="list-style-type: none">● Check and correct leakages Top up coolant● Get the hose replaced● Add oil● Fit the auxiliary water tank cap correctly● Get it rectified● Get it rectified

PROBLEM OBSERVED	PROBABLE CAUSE	ACTION TO BE TAKEN
	Electric fan not working	● Get defect rectified
	High delivery pressure in A.C. refrigerant circuit	● Get defect rectified
	Radiator fins clogged	● Clean it
	Radiator water passage clogged	● Get it rectified
	Thermostat defective	● Get it rectified
5. Charging indicator continuously remains ON	Battery not getting charged due to loose belt	● Get the belt tension adjusted Replace if broken
6. Poor pickup	Air in the fuel system	● Remove the air
	Clogged fuel filter	● Clean / Replace the element
	Clogged air filter	● Clean / Replace the element
	Clutch slipping/out of adjustment	● Get it rectified
	Brakes grabbing	● Get it rectified
7. Belt squeal	Loose belt	● Get belt tension adjusted
	Belt glazed	● Get belt replaced
8. Low engine oil pressure indicator 'ON' when engine is running even though engine oil level is within maximum/minimum marking	Pressure transducer faulty, and/or oil pump faulty	● Do not run the engine extensively. Take the car to the nearest Authorised Service outlet & get the fault rectified

Preliminary Trouble Shooting

CLUTCH & BRAKE

PROBLEM OBSERVED

PROBABLE CAUSE

ACTION TO BE TAKEN

CLUTCH

- | | | |
|-------------------------|--|---|
| 1. Clutch slipping | Improper pedal travel
Oil on clutch disc | <ul style="list-style-type: none">● Adjust pedal travel● Clean or replace disc |
| 2. Noisy clutch | Pressure plate & diaphragm spring rattling | <ul style="list-style-type: none">● Contact Authorised Service outlet |
| 3. Clutch hard shifting | Release bearing broken/worn out
Check push rod of the slave cylinder for any stickiness | <ul style="list-style-type: none">● Replace● Replace slave cylinder if necessary |

BRAKES

- | | | |
|----------------|---|---|
| 1. Poor brakes | Insufficient brake fluid
Air in the system
Pedal travel excessive due to excessive shoe gap
Vacuum leakage
Brake oil (line) leaking
Oil on the drum/liners

Worn brake lining / pads
Defective / worn parts | <ul style="list-style-type: none">● Get the brake fluid filled● Get the air removed● Rectify automatic adjuster
● Rectify the leakage● Replace the leaking line● Get the liners cleaned/replace seals if leaking● Get the liners replaced● Get them replaced |
|----------------|---|---|

PROBLEM OBSERVED	PROBABLE CAUSE	ACTION TO BE TAKEN
2. Brake pulling to one side	Oil on the brake lining One side shoe/pad worn Loose brake anchor plate One side brake pipe clogged Defective tandem master cylinder	<ul style="list-style-type: none"> ● Clean the brake lining ● Get the shoe/pad replaced ● Tighten the bolts ● Get the brake line cleaned ● Rectify/Replace tandem master cylinder
3. Brake Squeal	Defective brake lining Glazed lining Loose rivets. Wrong lining Shoe return spring broken Front pads rubbing on the disc	<ul style="list-style-type: none"> ● Replace ● Clean or replace lining ● Install rivets properly ● Install correct lining ● Replace ● Get it corrected
STEERING SYSTEM		
1. Hard steering	Less fluid in the power (For power steering) Air in the system Loose pump belt Low tyre pressure	<ul style="list-style-type: none"> ● Get the fluid topped up to the steering tank correct level ● Get the air removed by bleeding the system ● Get the belt correctly adjusted ● Adjust to correct value
2. Poor Returnability	Grabbing of linkages Steering gear disturbed	<ul style="list-style-type: none"> ● Check & rectify ● Check & adjust

PROBLEM OBSERVED	PROBABLE CAUSE	ACTION TO BE TAKEN
ELECTRICAL		
1. Battery charge & engine oil pressure lamp in cluster not operating when key is in 'IGN' position	Battery terminal loose or disconnected Battery completely dead Bulb fused Fuse blown Loose/open connections	<ul style="list-style-type: none"> ● Check connections ● Get the battery properly connected ● Get the battery charged ● Get the alternator & charging circuit checked ● Get the bulb checked
2. Non functioning Electrical accessories such as power windows, head lamps, fuel & temperature gauge, RPM meter, wiper & washer unit and all lamps etc.	Fuse blown in the circuit Loose connectors. Circuit relay/controllers loose in the base Defective components	<ul style="list-style-type: none"> ● Replace the fuse if blown ● Get the connection properly tightened/fixd ● Fix the relay firmly ● Get the defective components replaced at an Authorised Service outlet
SUSPENSION		
1. Abnormal or excessive tyre wear	Tyre out of balance Steering geometry disturbed Tyres not adequately inflated	<ul style="list-style-type: none"> ● Check balance and/or adjust if required ● Adjust steering geometry ● Adjust tyre pressure

PROBLEM OBSERVED	PROBABLE CAUSE	ACTION TO BE TAKEN
	Wobbly wheel or tyre Defective tyre Hub play not proper Brake grabbing Excessive braking	<ul style="list-style-type: none"> ● Replace wheel or tyre ● Replace tyre ● Adjust hub play ● Check and rectify ● Modify driving habit
2. Abnormal noise from front end	Worn, sticky or loose tie rod ends, lower ball joints OR tie rod in side ball joints. Warning noise for pad wear or mounting Worn suspension arm bushings Loose wheel nuts Loose suspension bolts or nuts Broken or damaged wheel bearing Excessive hub play Loose caliper housing bolts	<ul style="list-style-type: none"> ● Replace tie rod end, suspension arm, tie rod or drive shaft joints ● Replace pad ● Repair mounting ● Replace ● Tighten wheel nuts ● Tighten suspension bolts or nuts ● Replace ● Adjust ● Check & tighten
3. Suspension bottoms	Over loaded	<ul style="list-style-type: none"> ● Check loading

FUSES & RELAYS

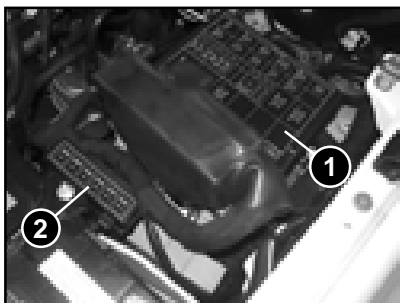

1. Fuse & Relay Box
2. Maxifuse Box

BLOWER 30 A	A/C CLUTCH 10 A		ECU BATT. 20 A	ECU IGN 5 A	SCM SUPPLY 1 20 A
SCM SUPPLY 2 20 A	ACC 10 A	CIGAR 10 A	REAR DIMIST 15 A	FRONT FOG 20 A	REV STOP 10 A
ENGINE GAUGE 10 A	ST. SOL. RELAY 10 A		CENT LOCKING 30 A	A/C SW. 5 A	W/W RLY. COIL 5 A
CO-DRIVER DOOR 30 A	DRIVER DOOR 30 A	RR DOOR (RH) 30 A	RR DOOR (LH) 30 A	PADDAL/DOOR AJAR LAMP 10A	ELECT. TAPING 10 A
COMBI SW. DIAGNOSTIC 10 A					

Cabin Fuse Box

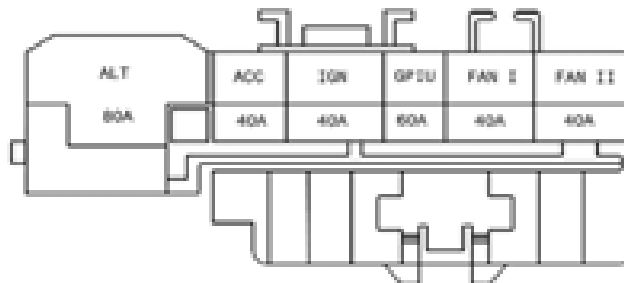

Maxifuse Box

FUSES & RELAY BOX

DUMMY	REAR MIST RELAY 12V, 30A NO	FRONT FOG RELAY 12V, 30A NO	RAD FAN-2 RELAY 12V, 40A	HORN RELAY 12V, 30A NO	SERIES FAN RELAY 12V, 30A NO					
	BEARING RELAY 12V, 30A NO	INTERNAL WIPER RELAY 12V, 30A NO/NO				STATER RELAY 70 A	AUXILIARY RELAY 70 A	DUMMY	DUMMY	DUMMY
CONDENSER FAN RELAY 12V, 30A NO/NO	A/C OUT OFF RELAY 12V, 30A NO/NO	MAIN RELAY 5 A	ECU MAIN RELAY 12V, 30A BOSCH	MAIN RELAY 5 A	MAIN RELAY 30 A	MAIN RELAY 10 A	MAIN RELAY 10 A	MAIN RELAY 15 A	MAIN RELAY 15 A	MAIN RELAY 15 A
HEAD LAMP HIGH BEAM RELAY 12V, 30A NO	HEAD LAMP LOW BEAM RELAY 12V, 30A NO	PARK LAMP RIGHT 5 A		PARK LAMP LEFT 5 A						
RAD FAN-1 RELAY 12V, 40A		HORN, BUZZ, 1 50 LAMP A		PARKING CONTACT 10 A		HEAD LAMP HIGH 30 A		HEAD LAMP LOW 30 A		

Electrical Maintenance

BULB SPECIFICATION

Bulb Specification :

DESCRIPTION	LOCATION	CAP TYPE	SPECIFICATION	QTY
Headlights (Halogen II4)	Head lamp	P43t	12V 60/55W	2
Front direction indicator	Front	BAU 15s	12V 21W	2
Side repeater indicator	Side	W2.1x9.5d	12V 21W	2
Tail lamp rear direction indicator	Rear	BA15s	12V 21W	2
Stop Light	Tail Lamp	BA 15s	12V 21W	2
Parking Light	Head lamp	BA9s	12V 4W	2
	Tail Lamp	BA 15s	12V 10W	2
Registration no. plate light	Registration plate light	BA 15s	12V 10W	2
Reverse Indicator lights	Tail Lamp	BA 15s	12V 21W	2
Warning and illumination lamps	Instrument Cluster			
Head light (main beam)		1.4 W wedge type	12V 1.4W	1
Turn Indicator		1.4W wedge type	12V 1.4W	2
Battery charging indicator		1.4W wedge type	12V 1.4W	1
Glow plug Indicator		1.4W wedge type	12V 1.4W	1
Low oil pressure indicator		1.4W wedge type	12V 1.4W	1
Malfunction indicator lamp (MIL)		1.4W wedge type	12V 1.4W	1
Check Engine indicator		1.4W wedge type	12V 1.4W	1
Over speed indicator		1.4W wedge type	12V 1.4W	1
Water in fuel sedimenter indicator		1.4W wedge type	12V 1.4W	1
Brake fall + Parking brake indicator		1.4W wedge type	12V 1.4W	1
Rear fog lamp		1.4W wedge type	12V 1.4W	1
Gauge illumination light		1.4W wedge type	12V 1.4W	6
Driver compartment light	Cab roof	SV 8.5	12V 10W	1 (For Pick-up Cab)
Driver compartment light	Cab roof	SV 8.5	12V 10W	2 (For Crew Cab)
Engine compartment light	Engine compartment	BA 15s	12V 21W	1
A/C Back Light	A/C Control Hsg.	W2 x 4.6d	12V 1.2W	6

The headlamps are provided with Halogen lamp and leveling device with single fitment for providing straight ahead illumination of the road for long distance or a dip beam which illuminates the road immediately ahead for short distance visibility. Use dip beam to avoid inconvenience /blinding the drivers of oncoming vehicles.

Head lamps adjustment should be always carried out at the authorized service outlet with the help of the screen.

Headlamp Bulb Replacement:

- Switch OFF the headlamps & ensure that the bulb is not hot.
- Open the engine hood and remove the headlamp protective cover of the main / dip beam lamp.

- Remove the locking clip to remove the main beam lamp with connector.
- Disconnect the lamp from the connector and Replace with new one with same rating and with right orientation.
- Connect and place the bulb right position, lock with clip and screw the protective cover.
- Remove other bulbs by twisting the bulb holder, after replacement fix holder.
- Switch On the headlamp and check lightning.

CAUTION

Don't touch or clean the headlamps it will damage the mirror finish of the surface.



1. *Rear Protective cover*
2. *Main beam lamp*
3. *Parking lamp*
4. *Direction lamp*
5. *Head lamp leveling motor*

The horizontal and vertical adjustments of the headlamp beam can be done by setting the knob of leveling motor.

BULB REPLACEMENT

When replacing the headlamps bulb, handle it by gripping the cap. Protect the glass from contacts with your skin or hard object. If you touch the glass, clean it with spirit & clean cloth. After replacement of the bulb in any emergency get the head lamp adjustment done at an authorized service outlet at the earliest.

CAUTION

Halogen head lamp bulbs get very hot when illuminated. Oil, perspiration or a scratch on the glass can cause the bulb to break due to the heat

Tail Lamp :

Bulbs Replacement :

Remove all bulbs by twisting the bulb holder after replacement fix the holder.

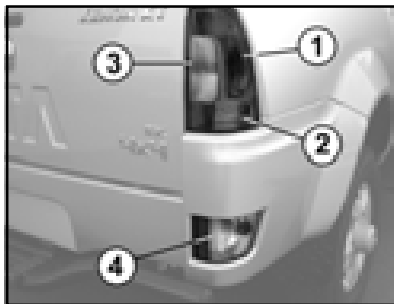

1. Parking Lamp
2. Direction indicator Lamp
3. Parking & Stop Light
4. Rear fog lamp & Reflector

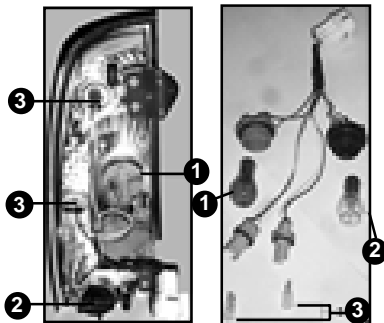

Fog Lamps :

Front and Rear fog lamps can be removed by twisting the bulb holder. After replacement fix the holder with the bulb.

Registration Plate Lamps :

Two concealed lamps are provided for illumination of the rear registration number plate

High Mounted Stop Lamp :

High mounted stop lamp is incorporated in the rear tail gate at the rear and it glows whenever service brake is applied.

Vehicle Care :

The Vehicle is subjected to many external influences such as climate, road conditions, industrial pollution and proximity to the sea. These conditions demand regular care of the Vehicle body. Dirt, insects, bird droppings, oil, grease, fuel and stone chippings should be removed as soon as possible.

Washing :

Do not wash the Vehicle in direct sunlight, wash in shade. Spray the Vehicle thoroughly with a cold water jet (Vehicle on a washing pit or hoist). Mix Vehicle shampoo in the wash water. No solvent (fuel, thinner) need be used.

NOTICE

Avoid wiping of painted surface in dry condition as it may leave scratches on the painted surface.

Use a soft bristle brush, sponge or soft cloth and rinse it frequently while washing. When you have washed the whole exterior, dry it with a chamois or soft cloth. After drying the Vehicle, inspect it for chips and scratches that could allow corrosion to start. Apply touch up paint where necessary.

NOTICE

Interiors of the Engine compartment cleaning with high pressure water should be avoided.

For Vehicles With Rear View Camera :

Use cover for camera during washing.

Polishes :

Polishes and cleaners can restore shine to the painted surface that has oxidised and become dull. They normally contain mild abrasives and

solvents that remove the top layer of the finish coat. Polish your Vehicle, if the finish does not regain its original shine after using wax.

Cleaning of Carpets :

Vacuum clean the carpet regularly to remove dirt. Dirt will make the carpet wear out faster. Periodically shampoo the carpet to keep it looking new.

Use carpet cleaners (preferably foam type). Follow the instructions that come with the cleaner, applying it with a sponge or soft brush. Keep the carpeting as dry as possible by not adding water to the foam.

Cleaning of Windows, Front & Rear Glasses :

Clean the windows inside and outside with commercially available glass cleaners.

WASHING & CLEANING

This will remove the haze that builds up on the inside of windows. Use a soft cloth or paper towels to clean all glass and plastic surfaces.

Maintaining The Vehicle When Not In Extended Use :

Park the Vehicle in covered, dry and if possible well-ventilated premises. Engage a gear.

Remove the cables from the battery terminals (first remove the cable from the negative terminal).

Make sure the handbrake is not engaged.

Clean and protect the painted parts using protective wax.

Clean and protect the shiny metal parts using commercially available special compounds.

Sprinkle talcum powder on the rubber windscreen wiper and rear

window wiper blades and lift them off the glass.

Slightly open the windows.

Cover the Vehicle with a cloth or perforated plastic sheet. Do not use sheets of imperforated plastic as they do not allow moisture on the Vehicle body to evaporate.

Inflate the tyres as per the specification and check it at regular intervals.

Check the battery charge every six weeks.

Do not drain the engine cooling system.

Proper Cleaning :

In order to protect your vehicle from corrosion it is recommended that you wash your vehicle thoroughly and frequently in case :

1. There is a heavy accumulation of dirt and mud especially on the underbody.
2. It is driven in areas having high atmosphere pollution due to smoke, soot, dust, iron dust & other chemical pollutants.
3. It is driven in coastal areas.
4. The underbody must be thoroughly pressure washed after every three months.

In addition to regularly washing your vehicle, the following precautions need to be taken.

Please Take The Following Precautions :

1. Always wash your vehicle in shade, avoiding direct exposure to sunlight during washing.
2. Dry wiping your vehicle may lead to the formation of

scratches and hence always use a soft cloth and clean water while wiping your vehicle.

3. Always keep your vehicle parked in a well ventilated shade. Exposure to heat with entrapped moisture promotes corrosion.
4. Avoid driving on gravel roads, as the possibility of paint chip off due to the impact of stones is high. If you are driving on freshly tarred road, check immediately afterwards for any stains & clean them.
5. External contamination in the form of sap or industrial fall-out may mar or develop spots on a new finish. Hence avoid parking your vehicle near trees, which are known to drop sap, or near factories, which give out heavy smoke.

6. The acid content in bird droppings may damage the newly painted finish and hence any bird dropping must be immediately washed off.

It is suggested to wash the vehicle by hand with cool and clean water using a soft cloth or sponge. Please do not use soap but a car shampoo recommended by your dealer.

OPENING & CLOSING THE BONNET

Opening & Closing the Bonnet

Opening :

1. Ensure that the vehicle is in neutral gear with the parking brake applied.
2. Pull the bonnet release lever located under the right hand corner of the dash board. The bonnet will pop up slightly.
3. Raise the bonnet slightly and with your finger lift the secondary lock lever located under the bonnet centre.
4. Lift the bonnet up. Pull the bonnet stay rod from its clip and insert the free end into the slot in the bonnet, slide stay rod outward to secure.

Closing :

1. To close the bonnet disengage the stay rod & clamp it properly.
2. Lower the bonnet and drop it from a short height to shut.

CAUTION

Ensure that the bonnet is properly locked before driving. Do not press the bonnet onto the bonnet lock.

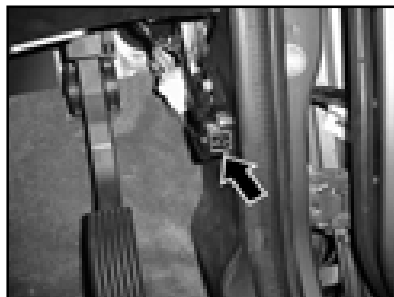

Location of Bonnet Release Lever



Bonnet Release Lever



Bonnet Opening Secondary Lock Lever

ENGINE COMPARTMENT (2.2L DICOR)

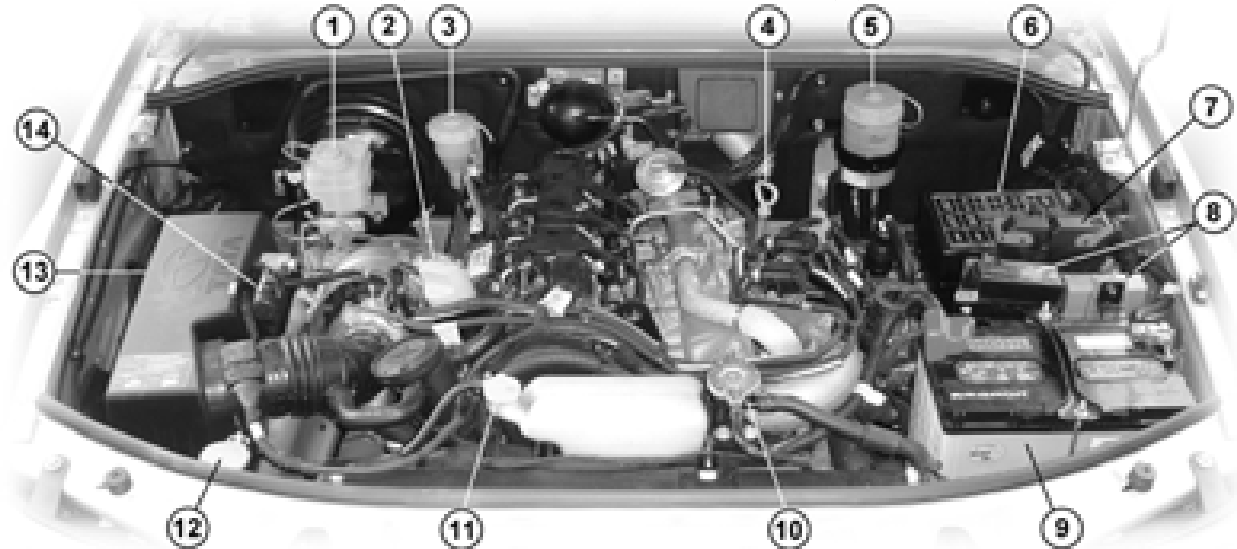

- 1. Brake fluid reservoir
- 4. Engine Oil Dipstick
- 7. E.C.U.
- 10. Radiator Cap
- 13. Air Filter

- 2. Engine Oil Filling Cap
- 5. Power steering reservoir
- 8. Fuse box / Relay
- 11. Auxiliary tank
- 14. Service Indicator

- 3. Clutch fluid reservoir
- 6. Fuse Box
- 9. Battery
- 12. Wind shield washer container

AIR FILTER & ENGINE OIL

Air Filter :

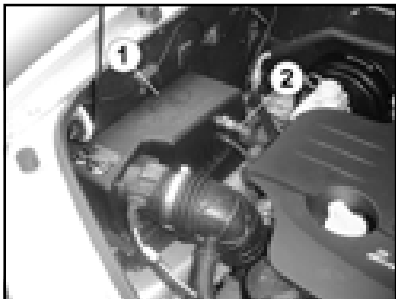

1. Air Filter 2. Service Indicator

The air filter element should be periodically cleaned. Replace the air filter element with a new one, when air cleaner service indicator shows red band, even after cleaning.

Always use a genuine air filter element.

The air filter is located on the LH side of the engine compartment.

a) When a vehicle is driven under dusty conditions, frequent

cleaning and replacement of the air-cleaner element is necessary.

b) Clogged air-cleaners lead to greater intake resistance and result in increased fuel consumption. Using low pressure compressed air, blow off dust on the air cleaner element. If the air cleaner element appears to be choked, replace it with a new one.

Engine Oil Level Checking :

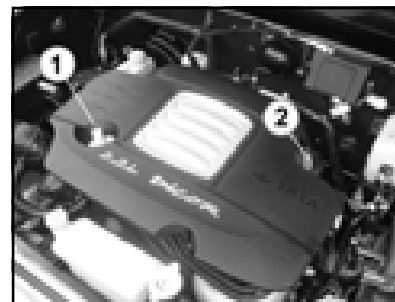

1. Engine Oil Filling Cap 2. Dip Stick

Warm up the engine to normal operating temperature.

Turn it off and wait 5 minutes for the oil to return to the oil pan

Be sure the Vehicle is on a level surface.

Pull out the dipstick, wipe it clean, and reinsert if fully.

Pull it out again and examine the oil level. It should be between 'Min' & 'Max' level. If not, top up with recommended engine oil.

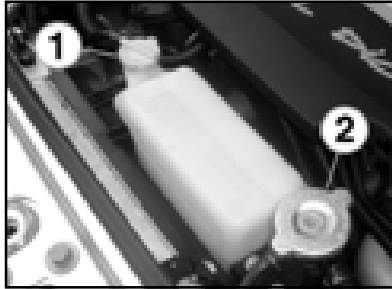
Engine Coolant Level :

1. Engine Coolant Filling Cap
2. Radiator Cap

The coolant level is visible through the translucent reservoir. It should be between max. & min. marks. If it seems less, add premixed coolant into the auxiliary tank upto the max. mark. Put the cap back properly.

 **CAUTION**

Never remove the filler cap when the engine is hot. Use only branded premixed ready to use coolant.

WARNING

Do not remove radiator cap when engine is hot. It may cause serious injury.

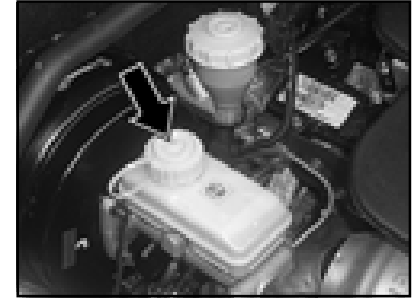
Brake Fluid Level :

Brake Fluid Container

The level of the brake fluid must be between the min. & max. marks on the side of the brake fluid container. If the level falls below the min. mark, add recommended brake fluid. (Refer chapter - Fuels, coolants & lubricants)

In case of spongy or hard pedal or low brake efficiency, please contact the nearest Authorised Service outlet.

POPWER STEERING FLUID

⚠ CAUTION

1. Do not allow brake fluid to make contact with the skin or eyes.
2. Do not allow brake fluid to splash or spill on the paint surface as it will damage the paint. In case of spillage, wipe it off immediately.

Power Steering Reservoir :



Power Steering Fluid Container

The level of the power steering fluid must be between the min. & max. marks on the side of the power steering fluid container. If the level falls below the min. mark, add recommended fluid. (Refer chapter - Fuels, coolants & lubricants)

In case of leakage or hard steering, please contact the nearest Authorised Service outlet.

⚠ CAUTION

Do not start the engine without oil in the power steering system.

LOAD CONSCIOUS PRESSURE REDUCING VALVE

Load Conscious Pressure Reducing Valve (LCRV) :

A LCRV is required in the brake system during severe braking. That time, most of the car weight is transferred to the front, and the front brakes do most of the braking. The rear wheels are left with but little traction and in this condition, under high pressure, they have a tendency to skid.

The valve is installed in the line to the rear brake drum. During heavy braking the valves limits the pressure to the rear wheels & this allows rear wheels to keep turning instead of locking up and skidding.

If any alteration is done in Rear suspension the performance of this valve will be impaired.

The valve stem gap should be adjusted whenever rear spring is changed.

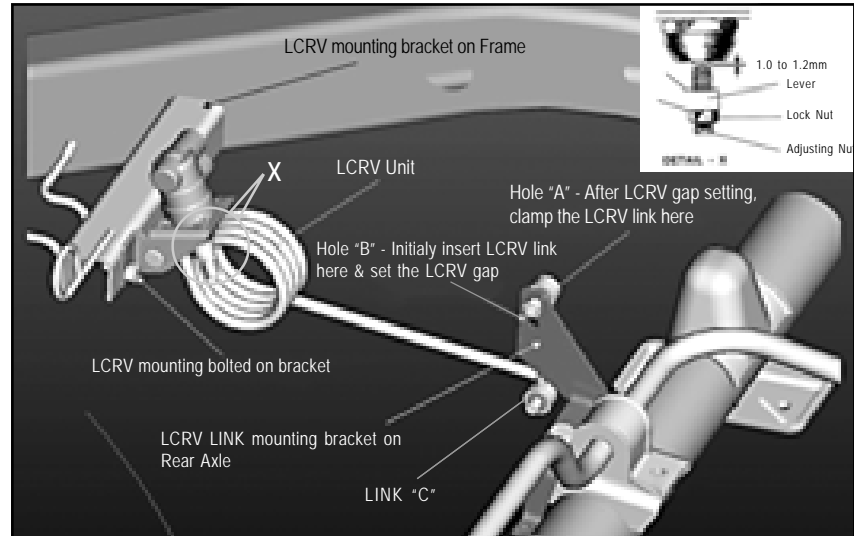
**Adjustment :****Valve Setting Method :**

With link 'C' in hole 'B' and vehicle in unladen condition, set the gap between valve piston stem & adjusting screw to 1.0 -1.2 mm

(as shown in figure) with the help of adjusting screw and locknut. Tighten locknut of adjusting screw. Then engage the link 'C' in hole 'A' i.e. upper hole of the bracket.

CLUTCH FLUID & FUEL SEDIMENTER

Clutch Fluid Level :



Clutch Fluid Container

The level of the clutch fluid must be between the min. & max. marks on the side of the clutch fluid container. If the level falls below the min. mark, add recommended clutch fluid. (Refer chapter - Fuels, Coolants & Lubricants)

Water Draining Procedure from Sedimenter :



Water Draining from Sedimenter

The water sedimenter is part of the fuel filtration system, fitted to the chassis frame, near fuel tank below the vehicle. It is used in the fuel supplying system in order to reduce the water content in the fuel provided to the DICOR system.

A water sensor is fitted to the water sedimenter in order to indicate to the driver that the sedimenter has to be drained. Whenever water in fuel sedimenter indicator glows in instrument cluster, the water need

to be drained from the sedimenter. Water drain operation to be done on sedimenter.

Procedure :

- 1 Stop the engine, and wait until pressure stabilizes.
- 2 Unclip one of the hydraulic connections (either inlet or outlet) and the electric connector of the water sensor.
- 3 Place a container underneath the water sedimenter.
- 4 Unscrew the water sensor about 2-3 turns.
- 5 Wait until all the water has drained out of the water sedimenter.
- 6 As soon as the flow is free of water, screw the water sensor to the required torque.
- 7 Clip the hydraulic connector and the electric connector to the water sensor.
8. Use hand primer / Pear pump to refill the line before restarting.

FUEL FILTERS & PRIMING / PEAR PUMP

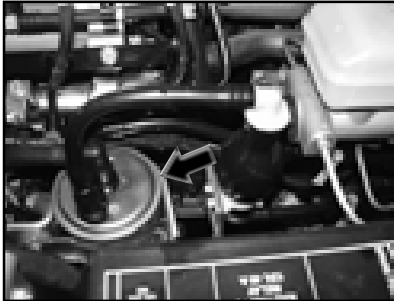
Fuel Filters :***Fuel Filter***

Fuel filter separates dust particles from the fuel & allows clean fuel in to the common rail system. It also separates & stores water.

Priming Pump / Pear Pump :***Priming / Pear Pump***

This is used for priming the fuel manually after overhauling of the engine or after refitment of fuel lines or after changing either fuel filter or sedimenter Pump, by means of priming pump / pear pump until all air in the fuel line removed. Before cranking the engine ensure that there is no air in the fuel system.

NOTICE

Do not loosen the HP lines of DICOR system for bleeding the air from fuel system.

WINDSHIELD WASHER & TYRES

Windshield Washer :



Windshield washer fluid container is located behind the front right hand side panel and its filler neck is provided near auxiliary tank in the engine compartment.

NOTICE

Do not add detergent or any solvent in the windshield washing water.

Tyres :

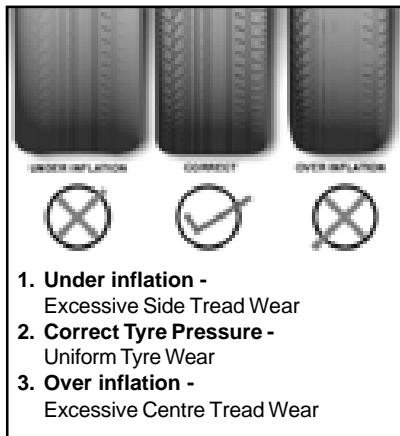

Check for inflation and condition of your car tyres periodically.

Inflation :

Check the pressure in the tyres when they are cold.

You should have your own tyre pressure gauge and use it at all times. This makes it easier for you

to tell if pressure loss is caused by a tyre problem and not by variation between gauges.

Keeping the tyres properly inflated gives you the best combination of riding comfort, handling, tyre life and better fuel efficiency.

Over inflation of tyres makes the car ride bumpy and harsh. Tyres are more prone to uneven wear and damage from road hazards.

Under inflated tyres reduce your comfort in car handling and are prone to failures due to high temperature. They also cause uneven wear and more fuel consumption.

Recommended Tyre Pressures : For 4x2 Vehicle

Veh. condition	Wheels	Tyre 205 R16
		PSI
Unladen	F	29
	R	29
Laden	F	29
	R	44

For 4x4 Vehicle

Veh. condition	Wheels	Tyre 215/75 R16
		PSI
Unladen	F	44
	R	44
Laden	F	44
	R	50



CAUTION

Every time you check inflation pressure, you should also examine tyres for damage, foreign objects & wear.

CAUTION

- Bumps or bulges in the tread or the side of the tyre. Replace the tyre if you find either of these conditions.
- Cuts, splits or cracks in the side of the tyre. Replace the tyre if you notice this on the fabric or cord.
- Excessive tread wear or non uniform tyre wear.

Repairing a Tyre/Tube :

Mark the tyre position suitably (if original colour dot mark is not visible) with respect to valve stem hole to ensure that the tyre is refitted in the original location on the wheel rim.

Ensure that balancing weights are not disturbed during removal of tyres.

Check the balance weight prior to the removal of the tyre. If found

loose, mark its location on the rim & refit properly.

Balance the wheel after every dismantling and assembly of tyre on the wheel rim.

While fitting wheels on the vehicle ensure that wheel pins are free from dust, scratches, dirt, dents, etc.

Ensure the tube being replaced has the correct valve.

NOTICE

Do not apply any oil on the wheel pins. Wipe off the oil if present.

CARE FOR TUBELESS TYRES & TYRE ROTATION

Special Care for Tubeless Tyres : (if fitted)

1. While removing tyre from wheel rim and mounting it back on wheel rim, take precautions not to damage tyre bead. Use tyre removal and assembly machines. Damage or cut on tyre bead may cause gradual loss of air and deflation of tyre.
2. Do not scratch inside of tubeless tyre with metallic or sharp object. Tubeless tyres are coated with impermeable layer of rubber from inside which holds the air inside the tyre. Removal of this layer due to scratching may cause gradual loss of air and deflation.
3. If wheel rim gets damaged in service, get the wheel rim repaired/replaced immediately. Running the vehicle with damaged rim may cause deflation of tyre and subsequent dislodging of tyre from rim.
4. Maintain recommended inflation pressure. Over-inflation, in particular, may cause puncture or bursting of tyre.

NOTICE

Life and wear pattern of tyres depends on various parameters like tyre pressure, wheel alignment, wheel balancing, tyre rotation, etc. It also largely depends on vehicle speed, load carried, usage, driving habits, road conditions, tyre quality, etc. In case fault is suspected to be due to poor quality of tyres, the same may be taken up with concerned tyre manufacturer.

Tyre Rotation :

To help increase tyre life and distribute wear more evenly you should have tyres rotated at specified intervals or earlier depending on the operation of vehicle. The illustrations shows how to rotate tyres when normal spare wheel is included in tyre rotation.

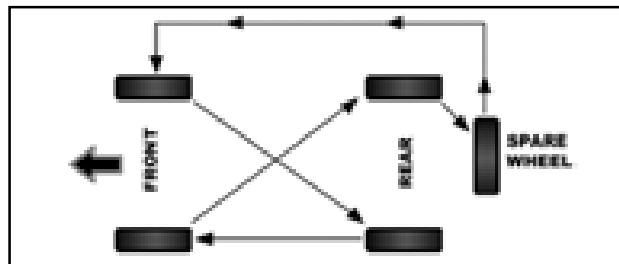

WHEEL ALIGNMENT, BALANCING, CATALYTIC CONVERTER MAINTENANCE

Wheel Alignment :

Incorrect wheel alignment causes excessive and uneven tyre wear. Check wheel alignment at specified intervals. Wheel alignment values are given below :

Caster : $3^{\circ} \pm 30'$

Camber : $0^{\circ} \pm 30'$

Toe in : 2 to 5 mm

On vehicles with torsion bar suspension, wheel alignment needs to be checked only after adjusting chassis height as per procedure. Chassis height for 16 inch tyre is 510 ± 3 mm. Check and maintain tyre pressure periodically to obtain longer tyre life.

Wheel Balancing :

Wheels of your vehicle are balanced for better ride comfort and longer tyre life. Balancing needs to be done whenever tyre is removed from rim.

1. Permissible imbalance for tyre with rim = 250 gm-cm max.
2. Total balance weight should be within 140 gms on each side.
3. Relocate the tyre if the weight required to balance is more than 140 gms.
4. Balance weights are available from 10 gms to 140 gms in steps of every 10 gms and from 15 gms to 135 gms in steps of every 10 gms.
5. Do not use more than one balance weight on one side.

Care for the Catalytic Converter

The catalytic Converter does not require any special maintenance however, following precaution should be taken for the effective functioning of the converter and to avoid damage to the Converter.

- It is mandatory to use Diesel fuel with sulphur content less than 0.035 %. Use of any other diesel fuel can increase the pollutants.

 **CAUTION**

Avoid parking the vehicle over inflammable materials, such as dry leaves, grass etc., as the exhaust system is hot enough to initiate 'FIRE'.

BATTERY

Battery :



Check the battery for proper electrolyte level and corrosion on the terminals.

1. Check the battery for electrolyte level against the marking on the battery outer case.
2. Check the battery terminals for corrosion (a white or yellowish powder). To remove it, cover the terminals with a solution of baking soda. It will bubble up and turn brown.

3. When this stops wash it off with plain water. Dry off the battery with a cloth or paper towel.
4. Coat the terminal with petroleum jelly to prevent future corrosion.

Use a proper spanner to loosen and remove cables from the terminals.

Always disconnect the negative (-ve) cable first and reconnect it last.

Clean the battery terminals with a terminal cleaning tool or wire brush.

Reconnect and tighten the cables, coat the terminals with petroleum jelly.

Ensure that battery is securely mounted.

If you need to connect the battery to a charger, disconnect both cables to prevent damage to the vehicle's electrical system.

NOTICE

During normal operation, the battery generates gas which is explosive in nature, a spark or open flame can cause the battery to explode causing very serious injuries.

Keep all sparks & open flames and smoking materials away from the battery.

Getting electrolyte in your eyes or on the skin can cause severe burns. Wear protective clothing and a face shield or have a skilled technician to do the battery maintenance.

The battery contains sulphuric acid (electrolyte) which is poisonous and highly corrosive in nature.

ITEM	SPECIFICATION	COMPANY & BRAND	QTY
ENGINE OIL	15W40 API CH4 +MB 228.3	CASTROL - Castrol GTX (Diesel) HPCL - HP Dieselino (T)CH4 EXXON MOBIL - Mobil Super 1000 TM 15W/40	7.5 Litres
COOLANT (Antifreeze agent + Soft water)	Class-II/JIS K2234	SUNSTAR - Golden Cruiser Premium 1400M HPCL - HP Thanda Raja P CASTROL - Radicool	Approx. 8 - 8.5 Litres
GEARBOX OIL	Synthetic 75W90 GL4	CASTROL - Castrol Syntro 75W90.GL4 HPCL - Gear Oil HP Gear EP 75W90(T) EXXON MOBIL - Mobilube 1 SHC 75W90	1.6 Litres
REAR AXLE OIL & FRONT LIVE AXLE OIL	85W140 WITH Anglamol 6043 (7%)	CASTROL - Castrol extra long life Rear axle oil 85W-140 HPCL - HP Gear Oil XP 85W140 T2 EXXON MOBIL - Mobilube HD 85W140	2.2 Ltrs (Rear) 1.2 Ltrs (Front)
POWER STEERING OIL	Power Steering Oil Dexron IID	CASTROL - TQD HPCL - HP -ATF Dex II EXXON MOBIL - Mobil ATF 220	1.4 Litres

FUEL, LUBRICANTS & COOLANTS

Fuel : High Speed diesel conforming to IS1460 or EN 590 or equivalent is recommended to be used as fuel.

At very low temperatures fluidity of diesel may slow due to paraffin separation. It is therefore necessary to mix supplementary fuel with summer or winter grade diesel. The supplementary fuel to be used is kerosene or aviation turbine fuel.

Ratio for mixing of supplementary fuel and diesel are shown in the table.

Ambient temperature upto Deg. C	Percentage	
	Summer grade diesel	Supplementary fuel
Upto 0	100	0
0 to -10	70	30
-10 to -15	50	50

Care should be taken that diesel and supplementary fuel are thoroughly mixed before filling.

Ambient temperature upto Deg. C	Percentage	
	Winter grade diesel	Supplementary fuel
Upto -15	100	0
-15 to -20	70	30
-20 and below	50	50

WARNING

Do not mix gasoline or alcohol with diesel. This mixture can cause an explosion.

NOTICE

Where an oxidation catalytic converter is fitted, it is mandatory to use Diesel fuel with sulphur contents as under. Use of any other diesel fuel can increase the pollutants.

Sulphur Content : (0.005% BS-III)

CAUTION

Due to the precise tolerance of diesel injection systems, it is extremely important that the fuel be kept clean and free from dirt or water. Dirt or water in the system can cause severe damage to Dicor system.

Do not add fuel additives with diesel.

Use low sulphur content fuel having a cloud point that is at least 10 degrees below the lowest expected fuel temperature. Cloud point is the temperature at which wax crystals begin to form in diesel.

Viscosity of the fuel **must** be kept above 1.0 centistoke to provide adequate fuel system lubrication at 40°C.

Engine Oil : Recommended grade of engine oil confirming to multi grade oil 15W40 API CH4 and MB 228.3 specifications & range of ambient temperature at which these can be used are as follows :

Ambient temperature upto Deg. C	Engine oil grade
-10 & above	SAE 15W40
-20 to 0	SAE 10W30
-10 & below	SAE 5W20

OIL FILLING & DRAIN POINTS

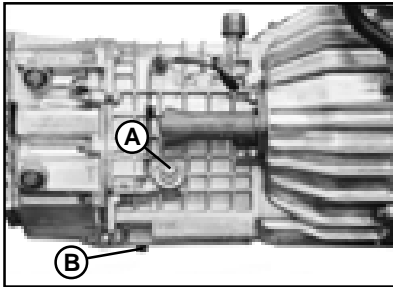

Gear box (G-76)
A. Oil Level Plug, B. Drain Plug

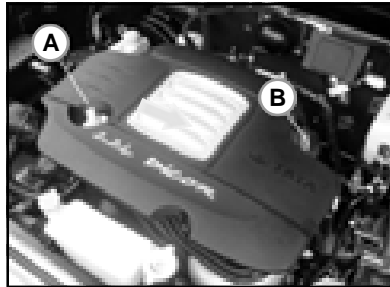

Engine (2.2 L Dicor)
A. Oil Filling Cap B. Dip Stick

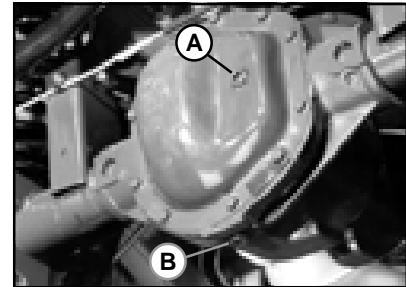

Rear Axle (Spicer)
A. Oil Level Plug B. Drain Plug

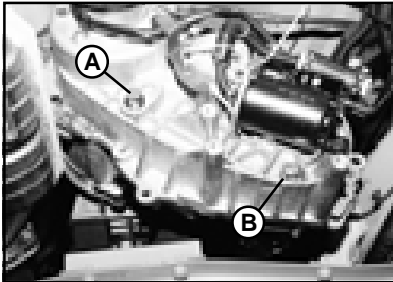

Transfer Case (4x4 vehicles)
A. Oil Level Plug, B. Drain Plug



Engine Oil Drain Plug

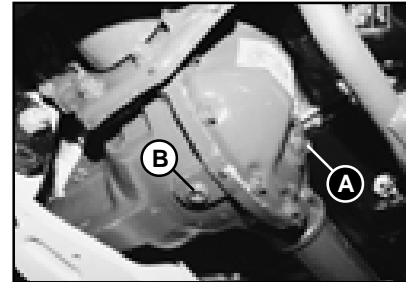

Front Live Axle (4x4) (Spicer)
A. Oil Level Plug, B. Drain Plug

TECHNICAL SPECIFICATION

1. ENGINE :		3. GEAR BOX :	
Model	: TATA 2.2L DICOR BS-III	Model	: GBS-76-5/4.1 with overdrive
Type	: Direct Injection Common Rail Turbo Charged Intercooled Diesel Engine	Type	: Synchromesh on all gears.
No. Of Cylinders	: 4 Inline	No. of gears	: 5 forward, 1 reverse.
Bore / Stroke	: 85 mm x 96 mm	Gear Ratios	: 1st - 4.10 2nd - 2.22 3rd - 1.37 4th - 1.00 5th - 0.77 Rev. - 3.75
Capacity	: 2179 cc	4. TRANSFER CASE (4X4) :	
Max. Engine Output	: 103 kw (140 ps) at 4000 rpm as per 80/1269/EEC	Type	: With electrical shift arrangement mounted on gear box with electronic controller unit.
Max. Torque	: 320 Nm (32 mkg) at 1700-2700 rpm as per 80/1269/EEC	Drive Option	: 4x2 - Ratio - 1:1 4x4 High - Ratio 1:1 4x4 Low - Ratio 1:2.48
Compression Ratio	: 17.2 : 1	5. REAR AXLE :	
Firing Order	: 1 - 3 - 4 - 2	Type	: Single Reduction, Salisbury Type Rear Axle with Hypoid Gears and Semi-Floating Axle Shafts & With limited slip differential.
2. CLUTCH :		Ratio	: 3.73 (41/11)
Type	: Single plate dry friction diaphragm type.		
Outside diameter of clutch lining	: 240 mm		
Friction area	: 503 sq. cm. (Approximately)		

TECHNICAL SPECIFICATION

6. FRONT AXLE		Load conscious pressure reducing valve : Provided for rear brakes
Type	: Independently suspended	
7. LIVE FRONT AXLE		Parking brake : Cable Operated Mechanical Linkages Acting on Rear Wheels.
Type	: Independently suspended with automatic hub locks	
Ratio	: 3.73 (41/11)	
8. STEERING		10. FRAME
Type	: Power Steering	Type : Ladder Type Cranked Frame with Boxed Section Long Members & Welded Cross Members. Depth : 110 mm (max.) Width : 60 mm. Tow Hooks at Front & Rear.
Ratio	: 18.2:1, 18.9:1 (Alternate)	11. SUSPENSION
Steering Wheel	: 400 mm dia. 4 Spoke Steering Wheel	
Steering column	: Provided with Tilt Mechanism for Height Adjustment.	Front : Double Wishbone Type with Torsion Bar.
9. BRAKES		Rear : Parabolic Leaf Springs.
Service brakes	: Vacuum Assisted Independent Hydraulic Brakes on Front and Rear wheels through Tandem Master Cylinder & Tandem Booster.	Shock Absorber : Hydraulic Double Acting Telescopic Type at Both Front & Rear.
Front brake	: 296 dia. Ventilated Disc Brakes with Twin Pot Calliper.	Antiroll Bar : At Front.
Rear brake	: 295 dia. Drum Brake with Auto Adjuster.	12. WHEELS & TYRES :
		Tyres & Tyre Pressure: 205 R 16 Tubeless tyre (For 4X2)
		Unladen: Front 29 PSI (200kPa) Rear 29 PSI (200kPa)
		Laden: Front 29 PSI (200kPa) Rear 44 PSI (300 kPa)

TECHNICAL SPECIFICATION

<p>215/75 R 16 Tubeless tyre (For 4X4) Unladen: Front 44 PSI (300kPa) Rear 44 PSI (300 kPa) Laden: Front 44 PSI (300 kPa) Rear 50 PSI (350 kPa)</p> <p>Wheel rims : 5.5 J x 16 (Premium versions - Alloy wheel rim ; Economy versions- Steel wheel rim).</p> <p>Wheel rim covers : Standard with Steel Wheel Rim (Economy Versions).</p> <p>No. of wheels : Front - 2, rear - 2, spare - 1</p>	<p>15. PERFORMANCE :</p> <p>Max. speed : 160 kmph</p> <p>Max. gradeability at rated GVW : 41 % (4x2 vehicle) 41 % (4x4 vehicle 4x2 mode) 90 % (4x4 vehicle 4x4 mode)</p>
<p>13. FUEL TANK :</p>	<p>16. WEIGHTS (kg) :</p> <p>Complete vehicle kerb weight as per ISO:1176 (with sparewheel and tools): 1860 (FAW-1070) (RAW-790)</p> <p>Gross Vehicle Weight : 2950 (FAW-1240) (RAW-1110)</p> <p>Max. Permissible FAW : 1400</p> <p>Max. Permissible RAW : 1800</p>
<p>Type : Made Out of Steel Sheet.</p> <p>Capacity : 65 litres</p>	<p>17. LOAD BODY - Crew Cab :</p> <p>Type : Pick-up type all Steel, Non - Integral Load Body, 90 deg Hinged Rear Tail Gate with Latch and Handle at Centre.</p>
<p>14. ELECTRICAL SYSTEMS</p> <p>System Voltage : 12 volts (-ve earth)</p> <p>Alternator Capacity : 125 Amperes.</p> <p>Battery : 12 V, 80 Ah MF</p>	<p>18. NET LOADING SPACE IN METERS :</p> <p>(Len. x Wid. x Ht.) : 1.43 x 1.41 x 0.40 - Crew Cab</p>

INFORMATION AT A GLANCE - DIMENSIONS

DIMENSIONS - TATA XENON CREW CAB

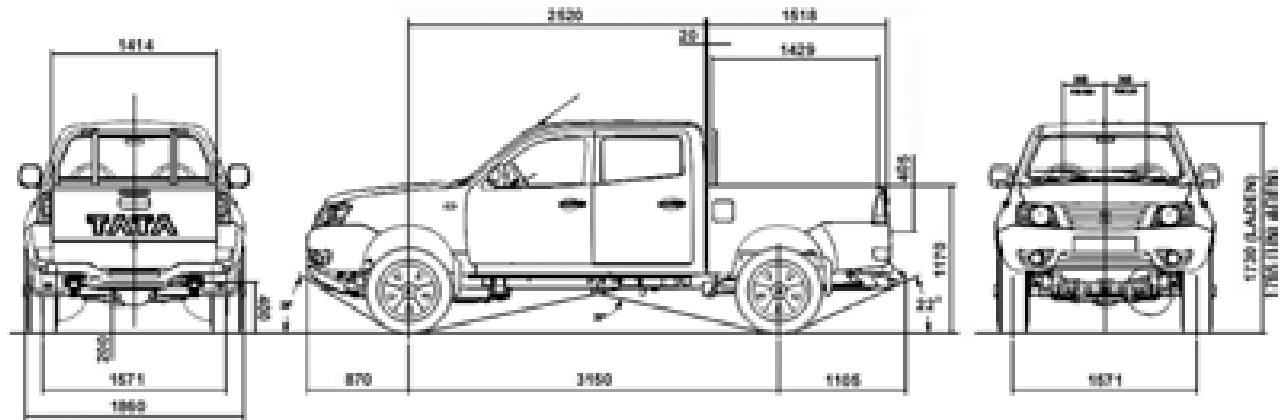

19. MAIN CHASSIS DIMENSIONS AS PER ISO:612 IN MM NOMINAL)

Wheel Base	: 3150	Rear Overhang	: 1105
Track Front	: 1571	Overall Height (Unladen / laden)	: 1765 / 1730
Track Rear	: 1571	Minimum Turning Circle Dia.	: 12.0 m
Overall Length	: 5125	Minimum Turning Clearance Circle Dia.	: 12.9 m
Max. Width	: 1860	Ground Clearance	: 200 mm
Front Overhang	: 870		

LOCATION OF AGGREGATE NUMBER



Chassis Number plate on Tie Member



Vehicle identification Number



Vehicle identification Number (VIN) on Frame

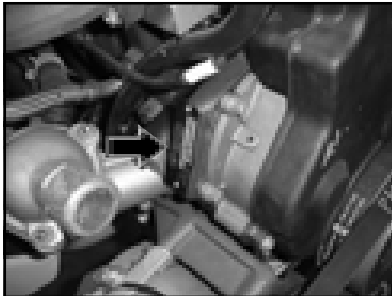

Engine Number Punch Location

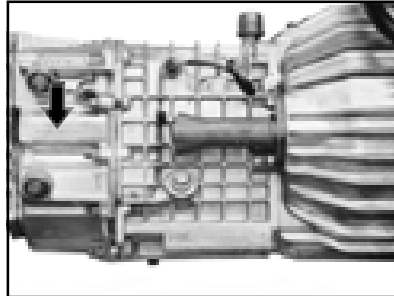

Gearbox Number (G-76)



Transference Number Plate (4x4)

LOCATION OF AGGREGATE NUMBER



Front Live Axle Number (4x4)

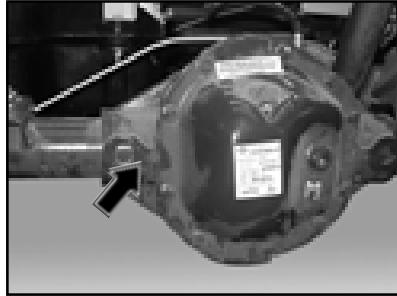

Rear Axle Number (Spicer)

SERVICE RECOMMENDATIONS

PRE- DELIVERY INSPECTION :**Following jobs are to be performed at PDI :**

1. Wash & Clean the vehicle thoroughly.
2. Road test the vehicle. Check for proper functioning of Engine, Clutch, Transmission aggregates, steering, Brakes etc.
3. Check vehicle behaviour : Pulling to LH/RH, Wobbling, Self centering, Acceleration etc.
4. Static test : Start engine & check for idling rpm & Maximum rpm (look for any abnormal noise), Water temperature etc.
5. Check Engine oil level. Level is acceptable if found between mid and max mark.
6. Check for any leakages of engine oil.
7. Check for any leakages in the fuel system.
8. Check Coolant level in transparent auxiliary tank. Acceptable if level found between mid and max.
9. Check for any Leakages of coolant.
10. Drain water from fuel water separator.
11. Check hose, clamps & pipes at all locations in cooling system.
12. Check hose, clamps & pipes at all locations in air intake system.
13. Check for leakages of gear box oil.
14. Check for Proper fitment of gear shift level rubber boot.
15. Check level of Clutch and brake fluid. Acceptable if found between mid and max.
16. Check for oil leakages in clutch/brake circuit.
17. Check clutch/brake pedal free play.
18. Check for fitment of split pins at Tie rod ball joints, Stub axles.
19. Check for fitment of grease nipples at all locations.
20. Check for leakages of front live axle oil (if applicable).
21. Check for leakages of rear axle oil.
22. Check tightness of propeller shaft Centre bearing bracket mounting nut & bolt (8 mkg).
23. Check Power steering oil level in reservoir. Acceptable if found between min & max marks.

SERVICE RECOMMENDATIONS

24. Check for oil leakages in power steering circuit.
25. Check for Steering wheel free play.
26. Check functioning of all bulbs.
27. Check for proper functioning of blinkers, horn, head lamp, parking light, reverse light, wiper system, washer system etc.
28. Check headlamp alignment and adjust if necessary.
29. Check tightness of electrical connection at battery, Starter Motor, Alternator & Starter relay.
30. Check all fuses.
31. Check all the earth points for looseness.
32. Check for functioning of all gauges/meters/warning lamps.
33. Check connectors in all electrical circuits.
34. Check for proper opening and closing of doors.
35. Check functioning of door locks, latches and windows.
36. Check for any complaints on cab fittings, instrument panel, glove box etc.
37. Check and tighten hand loose fasteners.
38. Check for any breakages, bends, failure of any component/assembly/unit.
39. Check for any fouling between two components which may lead to leakages or other complaints. Check for fouling of fuel lines, brake pipes, clutch pipes, air intake pipe, power steering hydraulic pipe, clutch/brake linkages, accelerator rod etc.
40. Grease with grease gun :
All locations appearing in lubrication chart.

NOTICE

While delivering a long storage vehicle (more than 6 months from production month), service/maintenance operations as prescribed by us for long storage, also needs, to be carried out before delivery.

NOTICE

Do not wash DICOR system components with forced water.

SERVICE OPERATIONS TO BE PERFORMED BY CUSTOMER

1. **THE VEHICLE HAS BEEN BUILT TO GIVE YOU THOUSANDS OF KILOMETERS OF ECONOMICAL AND TROUBLE-FREE PERFORMANCE. THIS IS HOWEVER, POSSIBLE ONLY IF THIS VEHICLE IS SYSTEMATICALLY MAINTAINED AND OPERATED STRICTLY ACCORDING TO THE INSTRUCTIONS CONTAINED IN THIS BOOK.**
2. **THE FREE SERVICES SHOULD BE AVAILED OF, AT THE FOLLOWING KM & TIME RANGE**

1st Free Service	At 1,000 - 1,500 km OR 1 month , whichever is earlier
2nd Free Service	At 5,000 - 5,500 km OR 12 months, whichever is earlier
3rd Free Service	At 15,000 - 15,500 km OR 24 months, whichever is earlier
4th Free Service	At 30,000 - 30,500 km OR 36 months, whichever is earlier
5th Free Service	At 45,000 -45,500 km OR 48 months, whichever is earlier
3. The respective service coupon should be detached and handed over to the concerned Servicing Agency for the service performed.

The selling dealer should fill up details of vehicle particulars on the inside cover page of the Owner's Manual.
4. These services can be satisfactorily performed only by one of our Authorised Dealers'/TASC's/TASP's Workshops in India, irrespective of the dealer who sold the vehicle, provided the vehicle is sent to them at the kilometerages specified and that this service book is produced before them.

The vehicle is entitled to pre-delivery service with free labour. After the delivery of the vehicle, in the subsequent '**5 free services' labour would be free but materials, if any would be charged for.**

All services, other than the above, must be paid for both for materials and labours; material at prevailing rates for the quantity consumed and labour at our scheduled rates available with our Authorised Dealers/TASCs/TASPs.
5. In the event of a schedule Service not performed within specified kilometers the respective coupons will be detached by the Authorised Dealer's Workshop when the vehicle is sent to them next. Should a major service have been missed, all the works listed for such service must be performed when the vehicle is taken next to one of our Authorised Dealer's/ TASC's/TASP's Workshop.
6. **It is an important condition of our sales policy that no warranty claims shall be entertained by us unless all services upto time of the claim arising have been performed on the vehicle by one of our Authorised Dealer's / TASC's/TASP's Workshops.**

SERVICE OPERATIONS TO BE PERFORMED BY CUSTOMER

Failure to carry out the services listed in this book can cause considerable damage to the vehicle and inconvenience to you. It is, therefore, in your own interest to take your vehicle to one of our Authorised Dealer's, TASC's, TASP's, Workshop for servicing.

7. All our Authorised Dealer's/TASC's Workshops have been equipped with special tools and are manned by technical personnel trained by us. Besides, they have adequate stocks of genuine spare parts for replacement purposes, should the need arise. Our Authorised Workshops are therefore in a position to render you any expert advice and service your vehicle may need. Please give them an opportunity to serve you, so that you may obtain economical and trouble free performance from your vehicle.
8. For any technical advice concerning your vehicle, please contact the nearest Authorised Dealer.

SERVICE OPERATIONS TO BE PERFORMED BY CUSTOMER

Sr. No.	OPERATION	FREQUENCY
1	Check engine oil level in sump, Top up, if necessary.	Daily
2	Check coolant level in auxiliary tank, top-up, if necessary with mixture of clean soft water and recommended anti-freeze additive in specified ratio.	Daily
3	Check and get rectified leakage of oil, fuel, brake/clutch fluid and coolant, if any.	Weekly
4	Check tyre pressure. Inflate tyres to specified pressure, if necessary.	Weekly
5	Check level of clutch & brake fluid in containers, top up, if necessary.	Monthly
6	Lubricate accelerator linkage with oil can.	Monthly
7	Grease with grease gun : (Where grease nipple is provided). Tie rod ball joints, Drag link ball joints, Idler arm ball joints and Centre link ball joints. Rear spring pins. Propeller shaft sliding yoke.	5000 km / Monthly
8	Check the performance of brakes by applying & releasing, when engine is running. Get it adjusted from Authorised Workshop if required.	Monthly
9	Check oil level in power steering tank & top up if necessary	Monthly
10	Check headlamps, gauges & instruments for proper functioning. Get it rectified if necessary	As and when required

Note : Do not wash DICOR system components with forced water

SERVICE OPERATIONS TO BE PERFORMED BY CUSTOMER

Sr. No.	OPERATION	FREQUENCY
11	Check exhaust system & Exhaust Gas Recirculation (EGR) system. Get it rectified, if necessary.	Monthly
12	Tyre rotation	15,000 km
13	Wash the vehicle & clean the condenser with compressed air.	As required
14	Check Air Filter service indicator. If RED BAND appears, clean the air filter. If 'RED BAND' reappears even after cleaning, get the air filter element replaced.	As and when red band appears.
15	Wheel balancing	Whenever a tyre is removed from wheel rim.
16	Check front tyre wear pattern. If there is an uneven tyre wear, get the front wheel alignment checked & adjusted. (If wear is uniform, do not disturb.)	As required
17	Check water level in windscreen washer container & top up if necessary	As and when required

Precaution to be taken while cleaning engine compartment :
It is recommended to use dry low pressure air. Do not use pressurised water.

SERVICE OPERATIONS TO BE PERFORMED AT WORKSHOP

	OPERATION	FREQUENCY	X 1000									
			1-1.5	5	15	30	45	60	75	90	105	
	GENERAL											
1	Wash the vehicle & Clean the condenser with compressed air	Every Service	x	x	x	x	x	x	x	x	x	x
2	Check & Top up Fluids if required: Coolant, Brake / Clutch Fluid, Battery Electrolyte, Power Steering Oil, Engine Oil, Gear Box Oil, Transfer Case & Front Axle (4X4) / Rear Axle Oil	Every Service	x	x	x	x	x	x	x	x	x	x
3	Drain water accumulated in Sedimenter (OR Whenever warning lampglows)	Every Service	x	x	x	x	x	x	x	x	x	x
4	Check fuel, brakes, power steering and clutch lines for leakages	Every Service	x	x	x	x	x	x	x	x	x	x
5	All standard checks as per job card	Every Service	x	x	x	x	x	x	x	x	x	x
6	Check & ensure normal working of engine using Diagnostic Equipment.	Every Service	x	x	x	x	x	x	x	x	x	x
	2.2L DICOR ENGINE											
1	*Clean air cleaner filter element, Change if red band appears on service indicator even after cleaning			x	x	x	x	x	x	x	x	x
2	*Change engine Oil and Oil filter.				x	x	x	x	x	x	x	x
3	Check All accessory Drive belts, adjust tension if required, change if damaged			x	x	x	x	x	x	x	x	x
4	Change fuel filter	30,000 km				x			x			x
5	*Replace air filter element (OR if RED band appears on Service Indicator)	45,000 km						x				x

Service Maintenance Schedule

SERVICE OPERATIONS TO BE PERFORMED AT WORKSHOP

	OPERATION	FREQUENCY	X 1000									
			1-1.5	5	15	30	45	60	75	90	105	
6	Change coolant in the cooling system	60,000 km						x				
OR 2 Years whichever is earlier												
7	Change Sedimenter / Water separator	1,05,000 km									x	
8	Change Timing Belt & Timing Belt Idler	1,05,000 km									x	
9	Change vacuum hoses for Vacuum Modulator, Turbocharger, EGR valve & throttle valve	60,000 km						x				
GEAR BOX												
1	*Change oil in gear box (First at 45,000 KM, there after every 90,000 KM)						x					
2	Change oil in transfer case (for 4X4)	45,000 KM					x			x		
3	Clean breather in gear box (also Transfer case in case of 4X4)	Every Oil Change					x			x		
PROPELLER SHAFT												
1	Grease propeller shaft with grease gun (at slip joint - splines end) & Check mounting bolts for looseness. Tighten if necessary Centre bracket	15,000 km			x	x	x	x	x	x	x	
FRONT AXLE (for 4x4) / REAR AXLE												
1	Change oil in axle (First at 15,000 KM, there after every 75,000 KM)				x						x	
2	Clean breather in Axle	15,000 km			x	x	x	x	x	x	x	

SERVICE OPERATIONS TO BE PERFORMED AT WORKSHOP

	OPERATION	FREQUENCY	X 1000								
			1-1.5	5	15	30	45	60	75	90	105
	SUSPENSION & STEERING										
1	Grease idler arm (seal type idler arm)& leaf springs shackle	15,000 km			x	x	x	x	x	x	x
2	Check wheel alignment & balancing, chassis height & adjust if necessary	15,000 km			x	x	x	x	x	x	x
3	Check condition of rubber bushes in the following & replace if necessary. 1) Top wishbone 2) Lower wishbone 3) Anti roll bar	30,000 km				x		x		x	
4	Check shock absorber, its bushes & replace if necessary	30,000 km				x		x		x	
5	Grease steering spindle and sleeve	30,000 km				x		x		x	
6	Check & adjust front wheel bearing play & Change grease in front hubs	45,000 km				x			x		
7	Change oil in power steering system & change filter element	75,000 km							x		
	CLUTCH & BRAKES										
1	Check parking brakes, adjust if necessary	15,000 km			x	x	x	x	x	x	x
2	Check front brake pads & rear brake linings. Replace if necessary	15,000 km			x	x	x	x	x	x	x
3	Change Clutch & Brake Fluid	30,000 km				x		x		x	
											(Or 2 years whichever is earlier)
	ELECTRICALS										
1	Check headlamp focusing & functioning of other electrical equipment			x	x	x	x	x	x	x	x
2	Check specific gravity of battery electrolyte	30,000 km				x		x		x	

Service Maintenance Schedule

SERVICE OPERATIONS TO BE PERFORMED AT WORKSHOP

	OPERATION	FREQUENCY	X 1000									
			1-1.5	5	15	30	45	60	75	90	105	
	HVAC											
1	Check the HVAC System for Satisfactory Performance & attend if required	Every Service	x	x	x	x	x	x	x	x	x	x
	WHEELS & TYRES											
1	Tyre rotation	15,000 km			x	x	x	x	x	x	x	x
	LOAD BODY											
1	Check and ensure proper tightening and alignment of load body fasteners. Check condition of rubber mounting.	15,000 km			x	x	x	x	x	x	x	x
2	Check and ensure proper locking of Tail gate. Adjust if necessary	Every service	x	x	x	x	x	x	x	x	x	x

* Under severe driving conditions, additional maintenance is required. Please Refer to “Additional Maintenance Schedule under severe driving conditions”:

Precautions to be taken while cleaning engine compartment : It is recommended to use dry low pressure air. Do not use pressurised water.

SERVICE OPERATIONS TO BE PERFORMED AT WORKSHOP

ADDITIONAL MAINTENANCE SCHEDULE UNDER SEVERE DRIVING CONDITIONS :

- A.. Driving in conditions such as Patrolling, Taxi, Pickup Van, Vehicle Towing, with Trailer Towing
- B. Driving on Dusty / Sandy roads
- C. More than 50% (in terms of kms) driving in heavy city traffic
- D. Frequently operating in mountainous area

	ITEM	INTERVAL	CONDITION			
			A	B	C	D
1	Engine Oil & Oil Filter	Change every 7500 kms.	x	x	x	x
2	Air Filter Element	Clean at every 7500 kms. & replace at 30,000 kms.		x		
3	Front (for 4X4) & Rear Axle Oil Change	Change First at 15000 kms & thereafter at 45,000 kms.	x	x	x	x

Record of Service Performed

Recommended Service	Date	Odometer Reading KMs.	Repair Order No.	Servicing Dealer's Signature & Stamp
At km				
PDI				
1500				
5500				
15,000				
30,000				
45,000				
60,000				
75,000				
90,000				
105,000				
120,000				

Recommended Service	Date	Odometer Reading KMs.	Repair Order No.	Servicing Dealer's Signature & Stamp
At km				
135,000				
150,000				
165,000				
180,000				
195,000				
210,000				
225,000				
240,000				
255,000				
270,000				
285,000				

Record of Service Performed

Recommended Service	Date	Odometer Reading KMs.	Repair Order No.	Servicing Dealer's Signature & Stamp
At km				
300,000				
315,000				
330,000				
345,000				
360,000				
375,000				
390,000				
405,000				
420,000				
435,000				
450,000				

Recommended Service	Date	Odometer Reading KMs.	Repair Order No.	Servicing Dealer's Signature & Stamp
At km				
465,000				
480,000				
495,000				
510,000				
525,000				
540,000				
555,000				
570,000				
585,000				
600,000				

Record of Repairs Carried Out

Chassis No. -

Date	Odometer Reading KMs	Repair Order No.	Particulars of Repair	Servicing Dealer's Signature & Stamp

Chassis No. - _____

Date	Odometer Reading KMs	Repair Order No.	Particulars of Repair	Servicing Dealer's Signature & Stamp

Record of Repairs Carried Out

Chassis No. - _____

Date	Odometer Reading KMs	Repair Order No.	Particulars of Repair	Servicing Dealer's Signature & Stamp

Chassis No.
Engine No.
Gear Box No.

2

At 5,000 - 5,500 km OR 12 months whichever earlier
please bring your vehicle for this service as per details
given in the Service Schedule.

**FREE
LABOUR**

L -

WORK DONE TO MY SATISFACTION

Sign. of Customer
Speedo Reading Km. seal O.K. / Broken
R.O. No. Date
Dealer's / Authorised Service Centre's
Stamp & Signature

At the time of delivery of vehicle please ensure
pre-delivery inspection has been carried out as per details
given in the Service Schedule.

PDI

Chassis No.
Engine No.
Gear Box No.

**FREE
LABOUR**

L -

WORK DONE TO MY SATISFACTION

Sign. of Customer
Speedo Reading Km. seal O.K. / Broken
R.O. No. Date
Dealer's / Authorised Service Centre's
Stamp & Signature

Chassis No.
Engine No.
Gear Box No.
Rear Axle No.

3

At 10,000 - 10,500 km OR 24 months whichever earlier
please bring your vehicle for this service as per details
given in the Service Schedule.

**FREE
LABOUR**

L -

WORK DONE TO MY SATISFACTION

Sign. of Customer
Speedo Reading Km. seal O.K. / Broken
R.O. No. Date
Dealer's / Authorised Service Centre's
Stamp & Signature

Chassis No.
Engine No.

1

At 1,000-1,500 km OR 1 month whichever earlier
please bring your vehicle for this service as per
details given in the Service Schedule.

**FREE
LABOUR**

L -

WORK DONE TO MY SATISFACTION

Sign. of Customer
Speedo Reading Km. seal O.K. / Broken
R.O. No. Date
Dealer's / Authorised Service Centre's
Stamp & Signature

Chassis No.

Engine No.

Gear Box No.

Rear Axle No.

At 20,000-20,500 km OR 24 months whichever earlier
please bring your vehicle for this service as per
details given in the Service Schedule.

4

**FREE
LABOUR**

L -

TATA MOTORS
WORK DONE TO MY SATISFACTION

Tata Sumo Grande

Sign. of Customer

Speedo Reading Km. seal O.K. / Broken

R.O. No. Date

Dealer's / Authorised Service Centre's

Stamp & Signature

Chassis No.

Engine No.

Gear Box No.

Rear Axle No.

At 30,000-30,500 km OR 36 months whichever earlier
please bring your vehicle for this service as per
details given in the Service Schedule.

5

**FREE
LABOUR**

L -

TATA MOTORS
WORK DONE TO MY SATISFACTION

Tata Sumo Grande

Sign. of Customer

Speedo Reading Km. seal O.K. / Broken

R.O. No. Date

Dealer's / Authorised Service Centre's

Stamp & Signature

