

YANMAR®



YANMAR
DIESEL TRACTOR

EF312T/EF352T

OPERATOR'S MANUAL

 **YANMAR AGRICULTURAL EQUIPMENT CO., LTD.**

TABLE OF CONTENTS

TO THE OWNER	2
SYMBOL INDICATION	3
SAFETY INSTRUCTIONS	4
AFTER SALES SERVICES	17
TRACTOR OUTLINE	18
PARTS NAMES	19
LABEL LOCATIONS	20
CONTROLS	21
OPERATIONS	29
1. Pre-operation checks	29
2. Brake-in (initial 50 hours)	33
3. Before starting	33
4. Start and stop	34
4-1. Start and stop engine	34
4-2. Start, gear shifting and stop tractor	35
5. Driving on a road	37
6. Driving on a slope	38
7. Driving in and out of fields	38
8. Setting adequate speed	38
9. Turning in a field	39
10. Differential gear lock	39
11. Loading and unloading	40
12. Adjusting wheel tread	41
13. Hydraulic power take off	41
14. Using 3-point hitch	42
15. Drawbar hitch	42
16. General precautions on attaching and detaching an implement	43
17. Power steering	44
18. Safety frame (ROPS) (optional equipment)	44
19. Tightening torque of bolts and nuts	44
OPENING BONNET AND SIDE COVER	45
AFTER OPERATION	46
PERIODICAL SERVICE	48
TROUBLESHOOTING	65
SPECIFICATIONS	68



TO THE OWNER

This new machine is carefully designed and manufactured to give years of dependable service. To do the better and safer job, read the instructions in this manual. Failure to do so could result in personal injury or machine damage.

Each section is clearly identified so you can easily find the information you need. Keep this manual next to your machine, after you have read through it. If you lose or damage this manual, ask a new manual to YANMAR dealer right away.

The parts used in this machine are subject to change to improve the quality and capacity of the machine, and for safety. Therefore, please understand that the contents, photos and illustrations in the manual may differ from your machine.

Please consult YANMAR dealer about any questions you may have and to receive updates to this manual.

Maintenance

When the machine is in abnormal condition, take the remedies. If the machine is still abnormal, ask YANMAR dealer and give the following information:

- Machine model
- Serial No.
- Hour meter reading
- Detailed description of abnormal condition

Supply Period For Maintenance Parts

The period that we supply maintenance parts for this machine is 9 years after we discontinue production of this machine.

The supply of maintenance parts will, in principle, terminate at the end of the supply period stated above. However, even after the supply period has terminated, we still consult with you about the delivery time and the prices for parts still in stock, if required.

Note:

1. All data are subject to alteration without notice. Some illustrations and photos may show optional accessories.
2. Right-hand (R.H.) and left-hand (L.H.) sides of this machine are determined by standing at the rear of this machine and facing the direction of forward travel.

● SYMBOL INDICATION

1.1 Safety-alert Symbol

- (1) This is the safety-alert symbol. When you see this symbol on your machine or in this manual, be alert to the possibility of personal injury and carefully read the messages that follow.
- (2) This stop symbol indicates important proper operation messages in this manual. When you see this symbol, carefully read the messages that follow.
- (3) This machine is of metric design. All hardware is therefore metric (ISO). Make sure you use the specified metric hardware when service becomes necessary.



1.2 Signal Words

The signal words "DANGER" "WARNING" "CAUTION" are used with the safety-alert symbol.

- (1) "DANGER" denotes the extreme hazard which would result in high probability of irreparable injury if proper precautions are not taken.
- (2) "WARNING" denotes the hazard which would result in injury if proper precautions are not taken.
- (3) "CAUTION" denotes the general precautions.



SAFETY INSTRUCTIONS

DANGER

Read these instructions carefully. Important instructions for safely operating and servicing the tractor are shown. Negligence of these instructions can result in an accident and serious injury.

LEARN TRACTOR AND IMPLEMENTS

Do not permit anyone unfamiliar with tractor and implement operations. An operator's manual should be considered a permanent part of your tractor and should remain with the tractor.

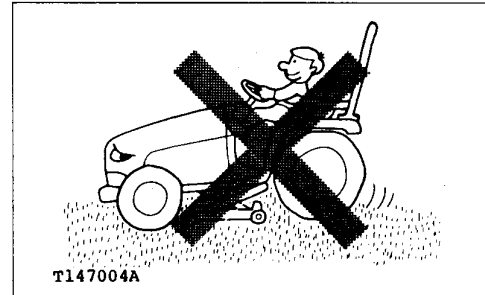

Know the positions and functions of all controls and meaning of any identification symbols on your controls, gauges, and indicators before attempting to operate the tractor.

Know how to stop the engine in an emergency.

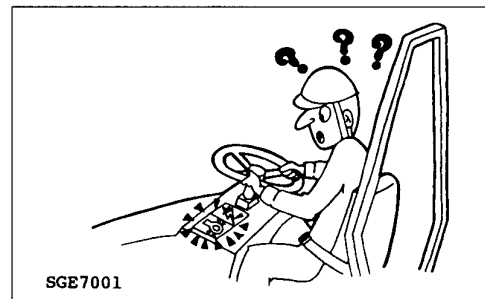

Know the capabilities, operating characteristics and limitations of the tractor and implement such as maximum ballast weights, hydraulic lifting capacity, speed, turning radius, operating clearances etc..

Do not add extra ballast weights to compensate for an overload.

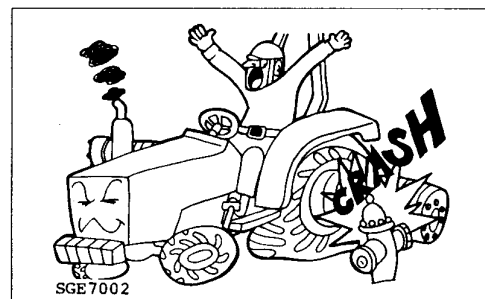

PROTECT OPERATOR SAFELY

Install approved rollover protective structure (ROPS) for safe operation. Overturning a tractor without ROPS can result in death or injury.

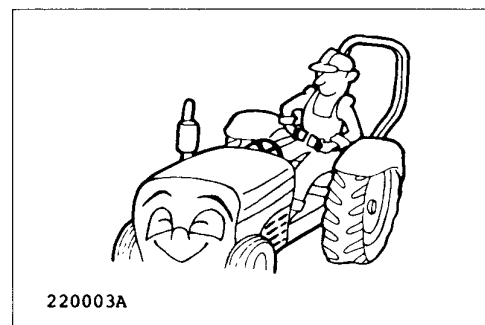

Extreme caution will be required when operating tractor around trees and other overhead obstructions such as guy wire or power lines. Interference between ROPS and these obstructions may cause tractor to tip over rearward.

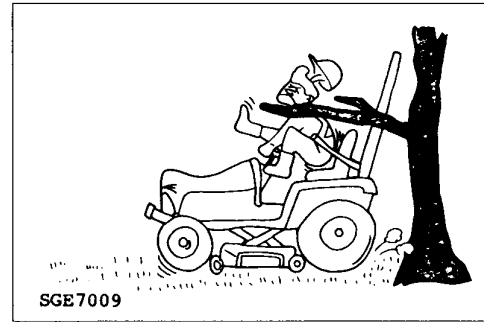

Do not modify structural members of ROPS by welding, bending, grinding or cutting. If any component of the ROPS is damaged or involved in an overturn incident, replace it with a complete new one and do not attempt to repair. Damaged or modified structural members impair the strength of the ROPS and may lead to injury.

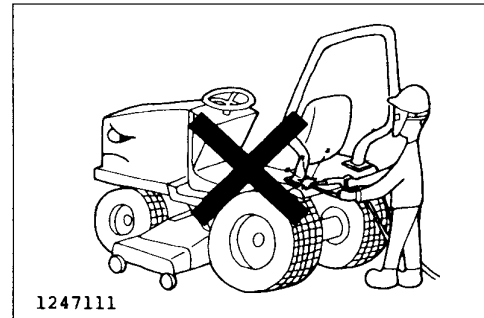

Avoid loose fitting or baggy clothing with tears, bulging pockets, frayed edges or heavy cuffs. Loose frayed and bulky clothing can easily become wrapped in revolving parts. Wear working clothing and working shoes or boots. Also you may need: **SAFETY HELMET, SAFETY SHOES, SAFETY EYE PROTECTION, HEAVY DUTY GLOVES, HEARING PROTECTION, REFLECTIVE CLOTHING, OR RESPIRATOR/FILTER MASK.**

Wear whatever safety gear and clothing is necessary for the job.

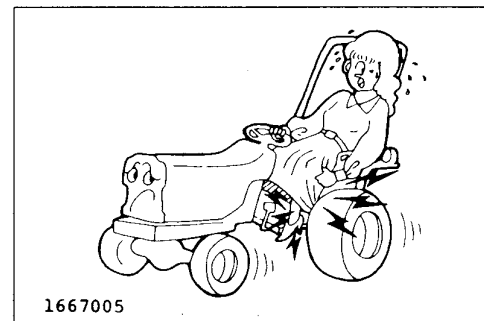

Prolonged exposure to loud noise can cause impairment or loss of hearing. Wear suitable hearing protective device such as earmuffs or earplugs to protect against objectionable and uncomfortable noises.

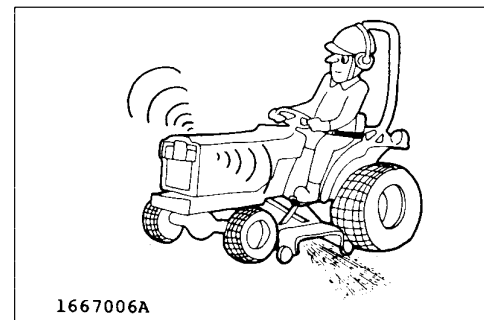

BEFORE OPERATING

Do not operate the tractor when tired, ill, sleepy, drunk, feeling overworked, taking medicines, pregnant, suffering mental disease or other improper conditions. These conditions impair a person's skill and judgment. When you begin feeling tired during operation, take a 10-minute break to stretch, walk about, lie down or snack. Do not continue if you still feel tired after taking a break.

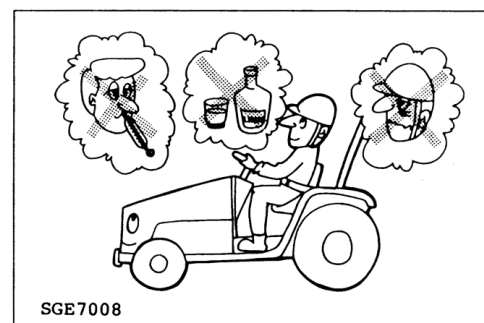

Remove oil, grease or mud from hand rails, steps, pedals, controls, and floor to avoid slippage.

In winter, scrape away ice and snow on above.

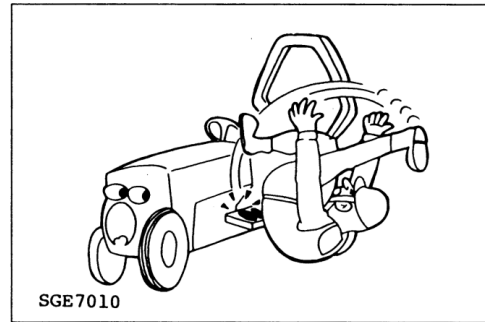

To attach or detach an implement, refer to the implement and tractor manufacturer's manuals for the proper procedures.

To unhitch an implement, move to a level area, lower the implement to the ground and then block the equipment in position before unhitching. If an implement has wheels, block them to prevent it from rolling.

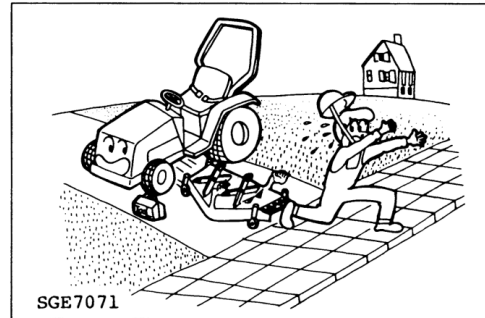

Make sure

- 1) The tractor and implements are in good condition and properly adjusted.
- 2) Check for bolts loosening, lubricants, damage or inflation pressure of tires, safety shields and devices, steering and braking linkages, hydraulic leaks, etc.. Refer to this manual for more detailed information.
- 3) Implements are properly attached and hooked up. Check that the PTO U-joint yoke and locking devices are securely latched on shafts.
- 4) Match implement PTO RPM rating to the tractor's.

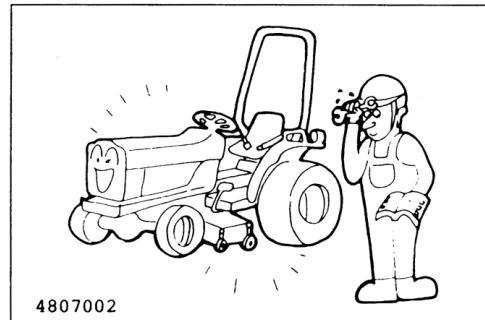

STARTING

START ENGINE SAFELY

If you operate the engine inside a closed building, be sure there is plenty of ventilation before starting the engine. Exhaust fumes are poisonous. Especially carbon monoxide which is odorless and colorless. You can easily be overcome without realizing it. While warming up the tractor, always attend the tractor and set the parking brake securely.

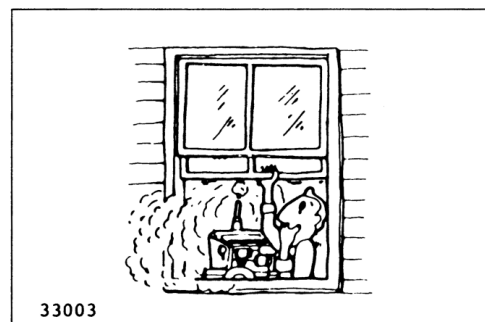

Start engine only from operator's seat. Do not start engine while standing on ground.

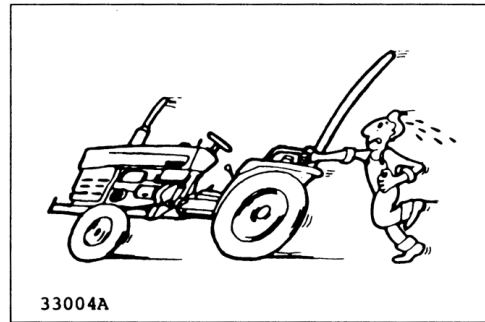

Before you start the engine:

- 1) Sit on the operator's seat and adjust seat positioning properly.
- 2) Check ROPS is in the working condition and fastened securely.
- 3) Lower an implement to ground.
- 4) Place speed shift lever and PTO switch in neutral.
- 5) Set parking brake.
- 6) Disengage PTO switch.
- 7) Check all instruments, gauges and indicator lights.
- 8) Be sure everyone is clear of the tractor and implement.

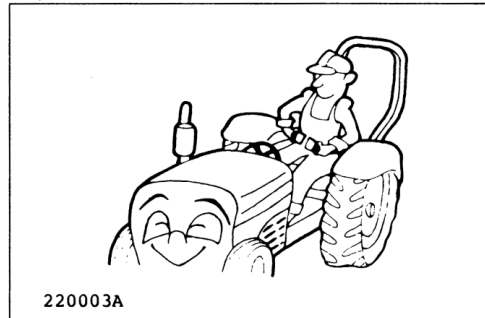

DURING OPERATION

OPERATE TRACTOR SAFELY

Keep people and pets a safe distance away when starting and operating the tractor and implement.

Do not permit any person other than an operator to ride or board on tractor or implements including wagons.

Do not play games with a tractor.
Never allow children to ride on your lap.

Do not touch muffler, radiator, engine or other high temperature parts before completely cooling down.

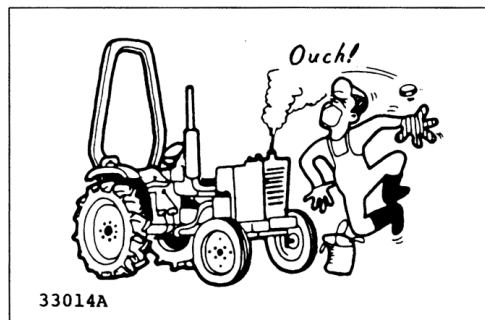
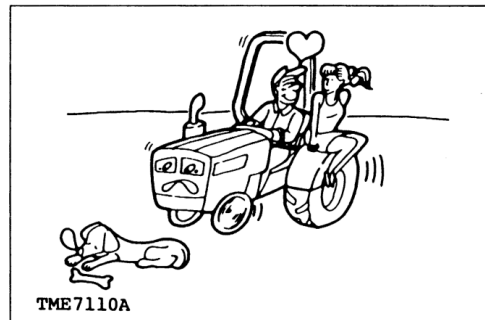

Do not try to get on or off a moving tractor or implements. Always use hand rails or steps and face tractor when getting on and off.
Never use control levers as a hand hold and never step on foot controls when getting on and off.
Do not get on tractor with wet or greasy hands or muddy shoes. Do not jump off tractor. Be aware of slippery conditions on the ground.

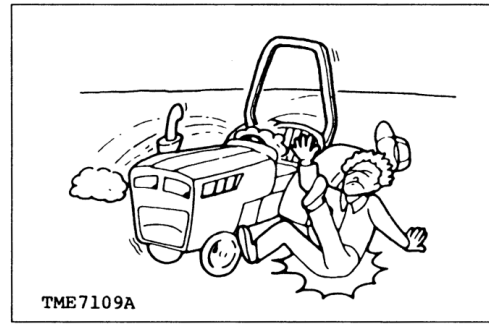

Keep hands, feet and clothing away from power-driven parts. Know the pinch and wrap points on your equipment. Keep others away from articulation joints, hitches, drawbar, lift arms, PTO drives, cylinders, etc..

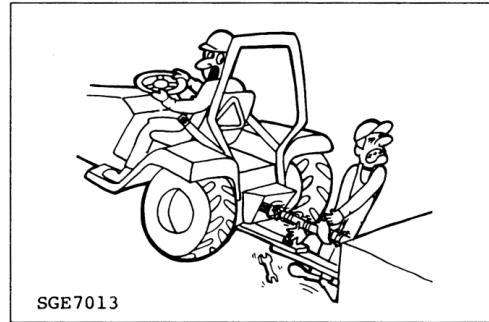

Never stand, or allow anyone else to stand, between the tractor and implement unless the engine is turned off and parking brake is engaged securely.

A too large implement is dangerous for tractor operation and for your safety refer to your implement operator's manual for minimum and maximum horsepower requirement and weight.
When using a heavy implement in front, always install rear ballast or rear implement for safe stability and steering control.

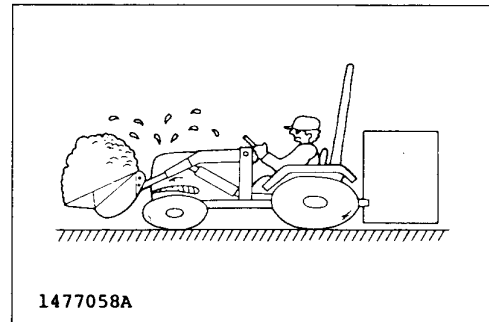

When using a heavy implement on rear 3-point hitch, always install front ballast or implement for safe stability and steering control.

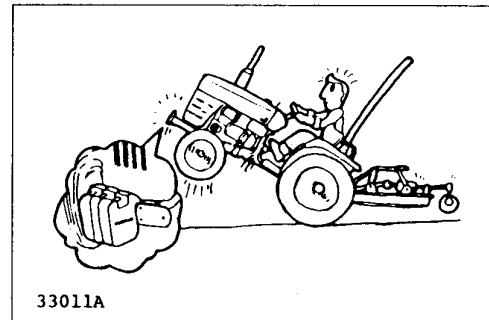

Slow down tractor over rough ground and in tall grass and weeds. Rocks, holes, stumps may be hidden in the brush.

Do not let your tractor bounce. You may lose steering control.

Never use the tractor to round up farm animals.



Do not allow the tractor to coast downhill with clutch disengaged, or with gear in neutral.

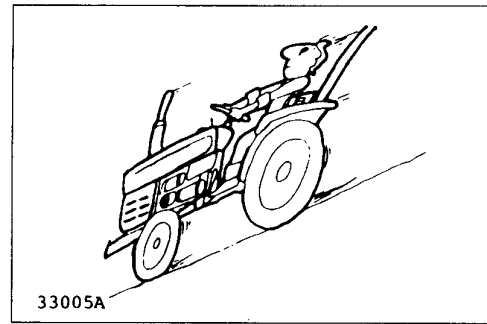

When operating the tractor on slopes, set wheel tread as wide as possible for maximum stability. Reduce engine speed and avoid hard application of brakes and sharp turns.

Stay off hills and slopes where are too steep.

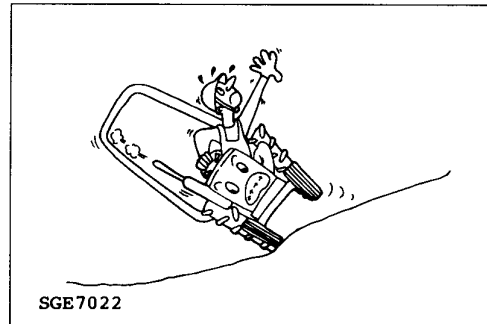

AVOID TIPPING

When starting tractor on uphill slopes, shift to as low as possible and reduce engine speed to avoid overturning rearward.

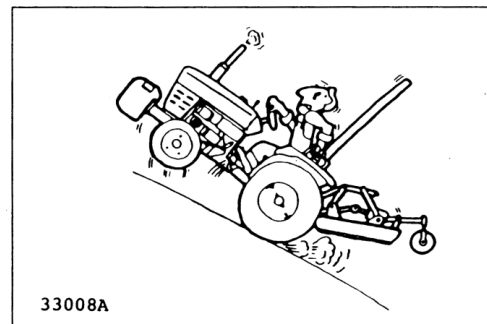

Do not drive near the edge of a gully or steep embankment. Avoid holes, ditches, etc. which may cause tractor to tip, especially on hillsides or steep slopes.

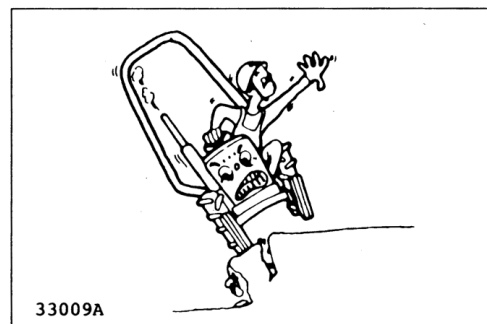

When operating on slopes or rough uneven ground, it is important to have as wide a distance between wheels as possible. Operate tractor carefully at the lowest speed.

Do not pull carts etc. from top link or top link hinge, rear axle, or any point above the drawbar. Doing so could cause tractor to tip over rearward. For pulling, attach to the drawbar only.

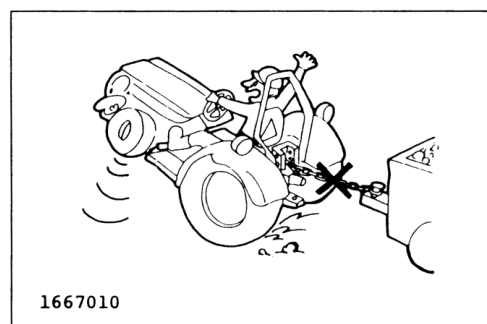

Use care when pulling loads or mounting heavy implement.

- 1) Use only approved hitch points.
- 2) Limit loads to that which you can safely control.
- 3) Limit travel speed to that you can safely control.
- 4) Do not turn too sharp.
- 5) Use care when backing.
- 6) Install proper ballast which is suggested in the operator's manual.

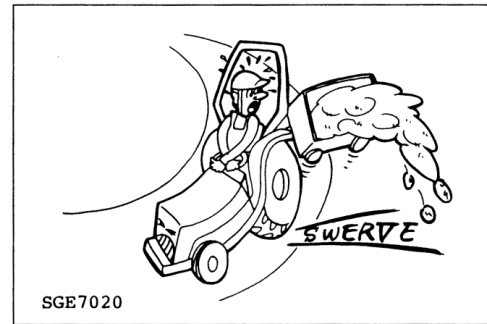

Driving forward out of ditch or mired conditions or up a steep slope could cause tractor to tip over rearward. If the mud is deep enough it keeps the wheels from turning, the tractor will rotate up and backwards around the axle very quickly. When caught in mired conditions, do not remove implement or ballast weight and always back out.

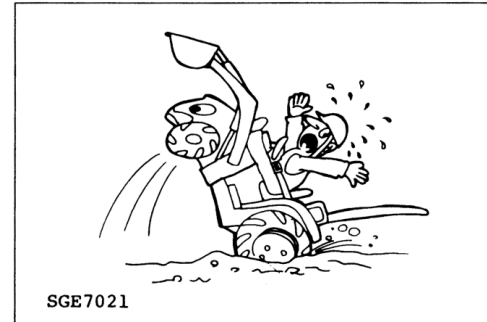

STAY CLEAR OF PTO

PTO master shield (A) should be in place at all times. PTO shaft safety guard (B) should be installed when PTO system is not in use.

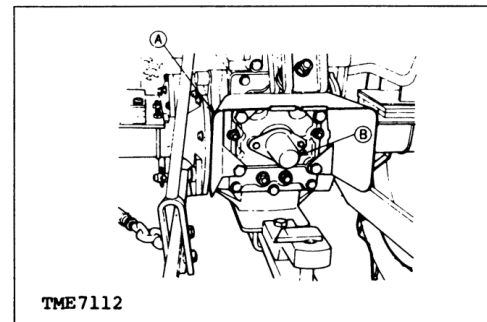

Make sure the tractor PTO speed is matched to the implement's required PTO speed.

Do not drive or operate implement beyond the tractor's PTO speed.

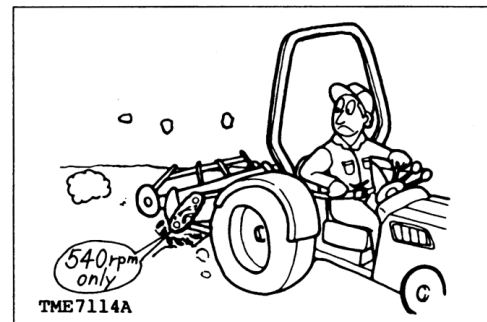

Stop engine and be sure PTO has stopped before:

- 1) Connecting or disconnecting PTO shaft.
- 2) Making any adjustment to PTO drive and 3-point hitch.
- 3) Adjusting, cleaning and servicing PTO driven implements.

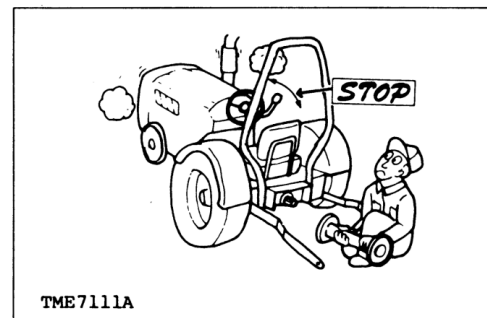

TRANSPORTING

Raise all implements and place in their locked-transport position.

Do not drive tractor on road with implements in motion.

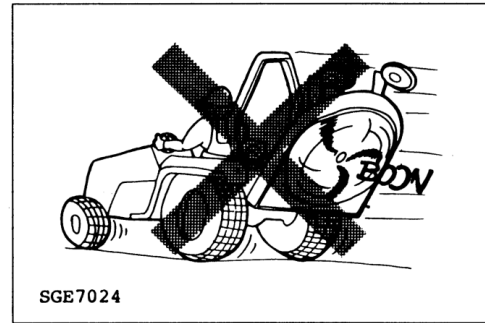

Couple brake pedals together at road speeds.
(only for two brake pedals type)

Do not make sharp turns at road speeds.

Always dim headlights before meeting another vehicle.
Keep light adjusted so they will not blind another vehicle.

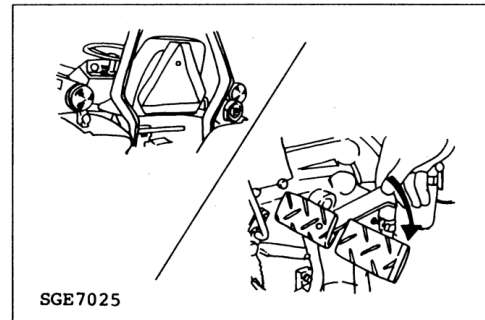

Before going down a steep hill, shift to the lowest speed to control tractor with a little braking. Do not coast downhill.

Do not stop or start suddenly when going uphill or downhill.

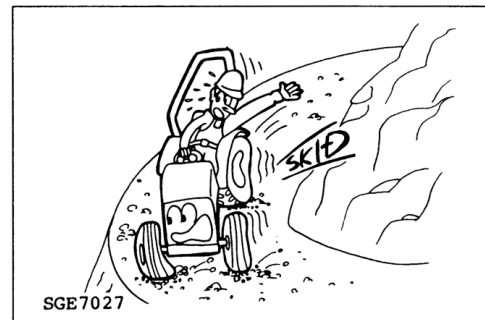

When loading (or unloading) tractor onto vehicle, use care as follows:

- 1) Use adequate loading ramp on loading dock.
- 2) Use lowest reverse speed when driving up loading ramp.
- 3) Set parking brake and wheel blocks firmly under vehicle wheels.
- 4) Do not try to drive onto trailer from ditch bank.

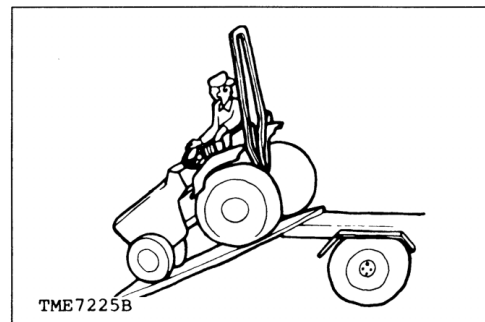

Secure load with chain binders and be sure they are tight.

If chain binders are not available, use rope, wire, blocks, or winch cable. Check load after traveling a few kilometers and every 100 km thereafter to make sure ties are not coming loose. Also, check after rough road bumps.

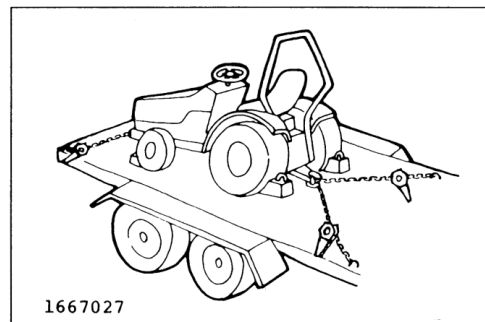

TOWING

A towed load of more than the weight of the tractor should have its own brakes. When towing, drive slowly and avoid hills and hard applications of brake.

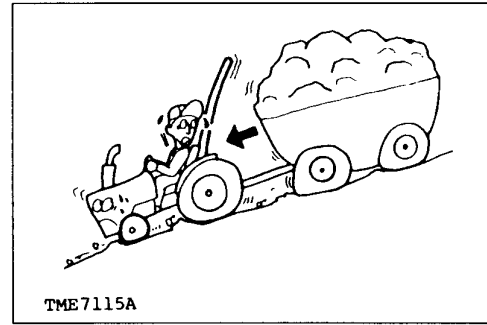

A safety chain will help control a drawn implement, should it accidentally separate from drawbar while transporting. Using appropriate adapter parts, attach chain to tractor drawbar support or other specified anchor location. Provide only enough slack in chain to permit turning.

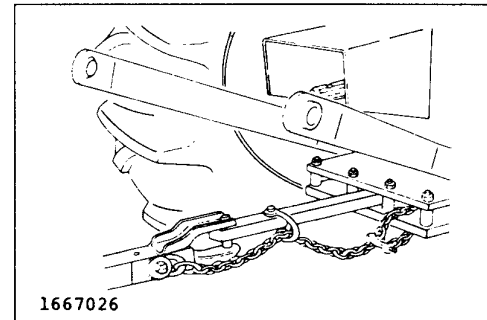

Do not tow tractor faster than its maximum travel speed in the highest gear and not more than 25 km/h (16 mph).

Check local regulations for towing. Towing is illegal in some countries.

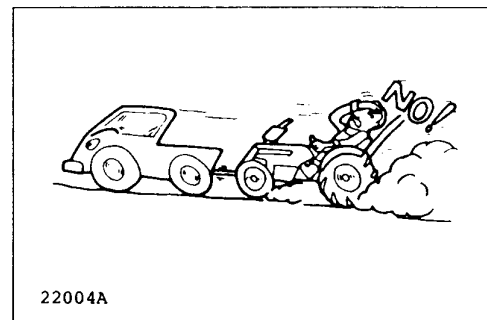

AFTER OPERATION

LEAVE TRACTOR SAFELY

Keep tractor on a firm level surface when parking. When parking the tractor, couple brake pedals together and set parking brake securely. When parking unavoidably on a slope, position it at right angles to the slope and set parking brake securely and block both front and rear wheels.

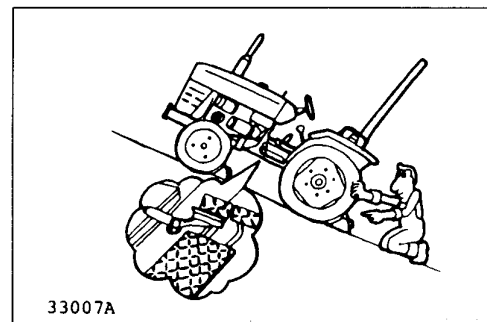

Take all possible precautions as follows when leaving tractor unattended:

- 1) Disengage PTO and lower implement to ground.
- 2) Shift all shift levers to neutral.
- 3) Couple brake pedals together and set parking brake lever.
- 4) Run engine to cool for 2 to 3 minutes at one-third throttle speed and no load.
- 5) Stop engine and remove key.
- 6) Cycle hydraulic controls to eliminate residual pressure.

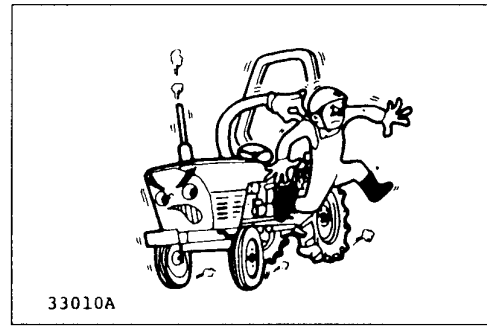

MAINTENANCE AND SERVICE

AVOID EXPLOSION OR FIRE

Refuel tractor when engine is cool and in well-ventilated area, preferably outside.

Never fill the fuel tank with the engine running.

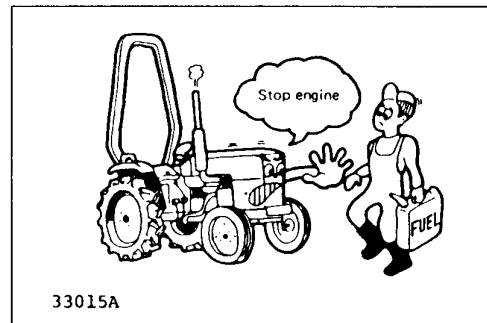

Be sure to use the correct type and grade of fuel.

Keep all sparks, flames and smoking materials away while handling fuel.

Ground the fuel funnel or nozzle against the filler neck to prevent sparks.

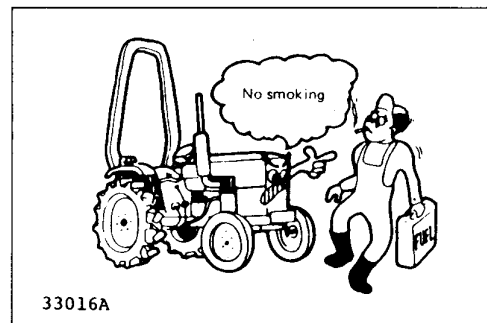

Do not overfill the tank or spill fuel. If fuel is spilled, wipe off immediately. Install fuel tank cap securely after refilling.

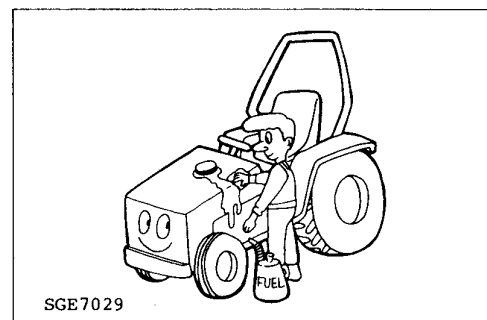

Be sure there is a plenty of ventilation before charging battery. Gas of battery is explosive.

Keep all sparks, flames, and smoking materials away from battery. Hydrogen gas from battery-concentration as low as 7 per cent-can explode in presence of spark or open flame and spatter acid. Use flashlight to check battery electrolyte level and never use open flame.

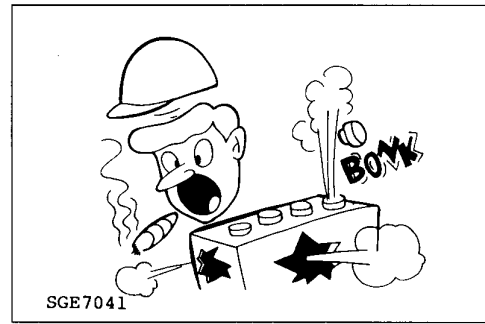

Keep engine free of grass, leaves, or excessive grease.

Let engine cool down before storing tractor in any enclosure or covering it with sheet.

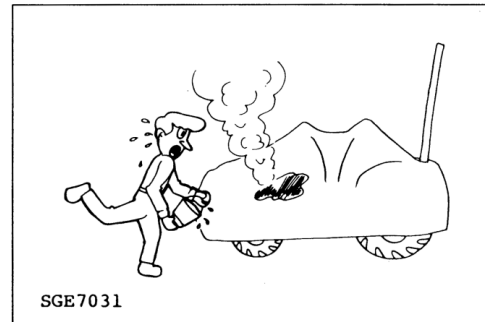

Do not service tractor while it is in motion or while engine is running.

When servicing tractor, always set parking brake, block wheels, lower implement, release all hydraulic pressure and place all controls in neutral.

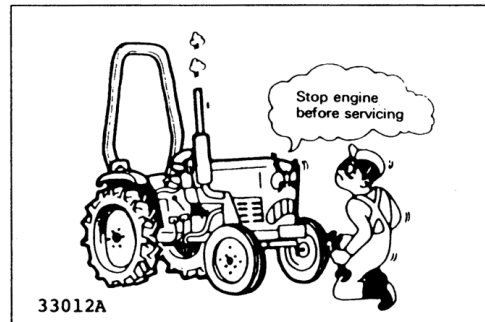

Use correct tools and equipments.

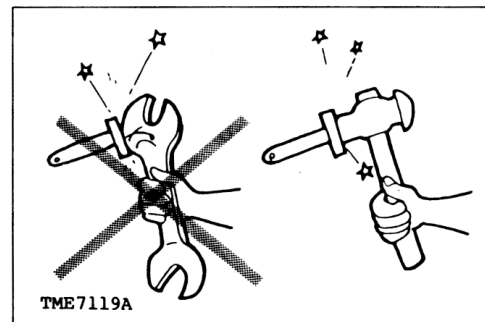

Unauthorized modification to tractor may impair function and/or safety, and effect tractor life.

Do not use substitute parts that may not meet strength and design requirements or may not fit correctly in original tractor.

Do not use repair parts not approved by YANMAR.

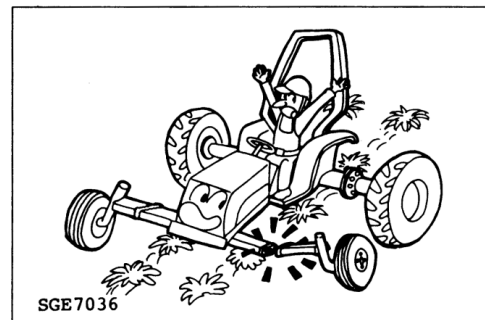

Remove radiator cap only when coolant temperature is cool. Wait at least one hour to allow coolant to cool down.

Cover radiator cap with a cloth before opening and gradually release pressure before completely removing cap.

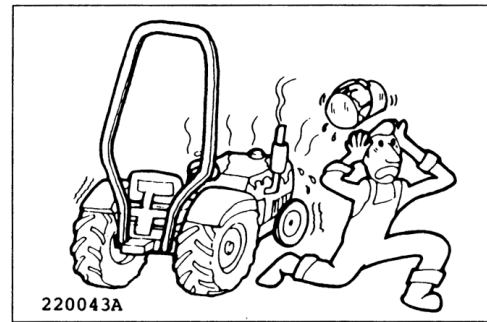

Do not service hydraulic system when hydraulic oil is hot.

Do not adjust relief valves to higher pressure than tractor or implement recommended specifications.

Do not close off overflow or bypass lines.

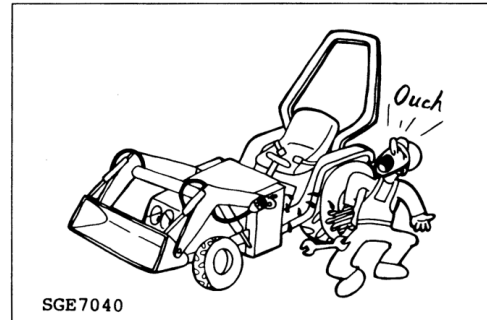

Hydraulic oil or diesel fuel escaping under pressure can penetrate the skin, causing serious injury. Before disconnecting lines, be sure to relieve all pressure. Before applying pressure, be sure all connections are tight and all components are in good condition.

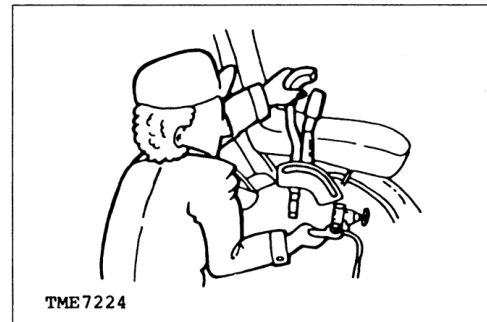

Fluid escaping from very small hole can be almost invisible. Wear safety goggles for eye protection and use a piece of cardboard to check for suspected leaks. Do not use your hands. If injured by escaping fluid, see a doctor at once. Serious infection or other problems can develop if proper medical treatment is not administered immediately.

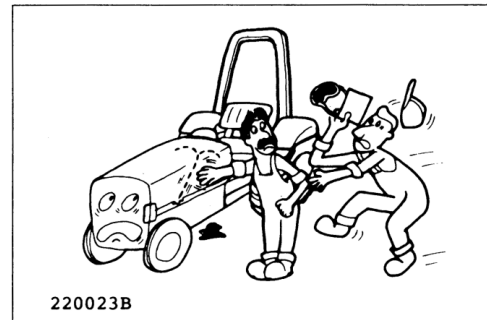

Disconnect battery ground cable before working on electrical system or working in any area where you might come in contact with electrical components. Disconnect ground cable first and replace at last.

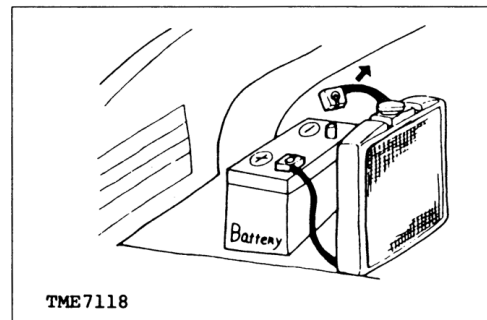

Sulfuric acid in battery electrolyte is poisonous. It can destroy clothing and burn the skin. Wear eye protection and rubber gloves when filling battery. If you spill acid on yourself, flush your skin with water and apply baking soda or lime to neutralize acid, then get medical attention immediately. If acid is swallowed, get medical attention immediately!

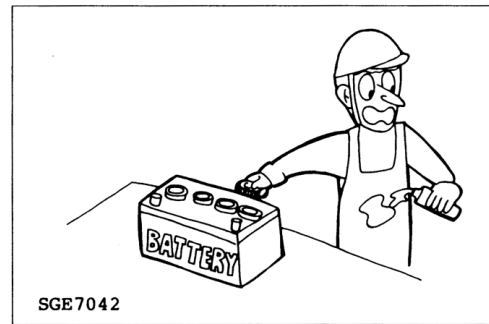

STORAGE

Whenever tractor will not be used for a few months, use following safety precautions:

- 1) Drain fuel tank.
- 2) Lower implement.
- 3) Set parking brake and block wheels.
- 4) Remove battery and store in cool, dry place, and keep out of reach of children.

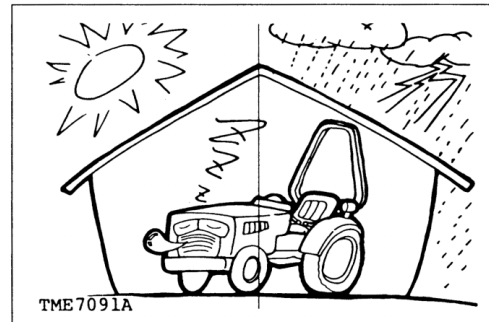

AFTER SALES SERVICES

After sales services

When your tractor is not working normally, check it referring to the troubleshooting section. You can of course consult with your service representative.

Whenever you ask service to your service representative, following information are very helpful to identify your tractor.

- 1) Tractor model name and serial number (A).
The serial number is stamped on right side of front frame (B).
- 2) Engine model name and serial number (C).
- 3) Hour-meter (D) reading or estimated hours of operation.
Turn on key switch to read hour-meter.

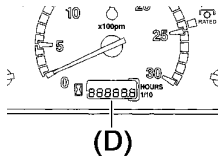

- 4) Operating conditions.
Kind of work and implement used when a problem is happened.
- 5) Any other information when a trouble is occurred.
Noise, vibration, function etc.

Availability of spare parts

Maintenance parts or spare parts are available for 10 years after the production of this tractor series has been discontinued. However, special parts will be subject to consultation. Yanmar may be able to supply a particular part after the normal supplying period.

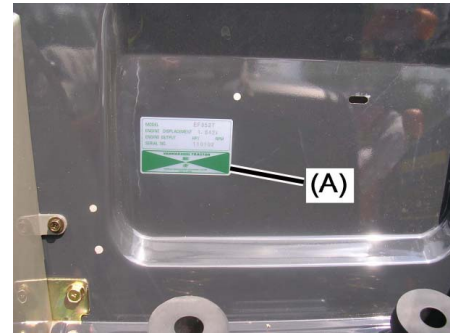

(A) Tractor model name & serial number

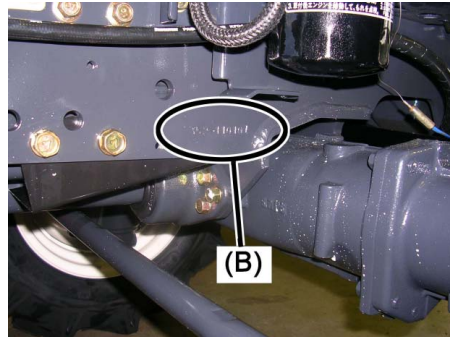

(B) Tractor serial number

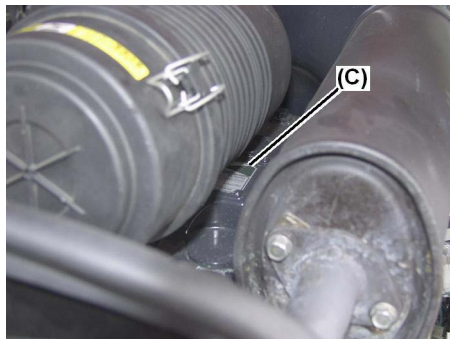

(C) Engine model name & serial number

TRACTOR OUTLINE

- | | | | |
|-----|-------------------|------|---|
| (1) | Head light | (8) | Bonnet |
| (2) | Side light | (9) | Side cover |
| (3) | Muffler tail pipe | (10) | Front tire |
| (4) | Fuel refill port | (11) | Rear tire |
| (5) | Operator's seat | (12) | Lower link (3-P) |
| (6) | Turn signal lamp | (13) | ROPS (Safety frame, optional equipment) |
| (7) | Sub-step | | |

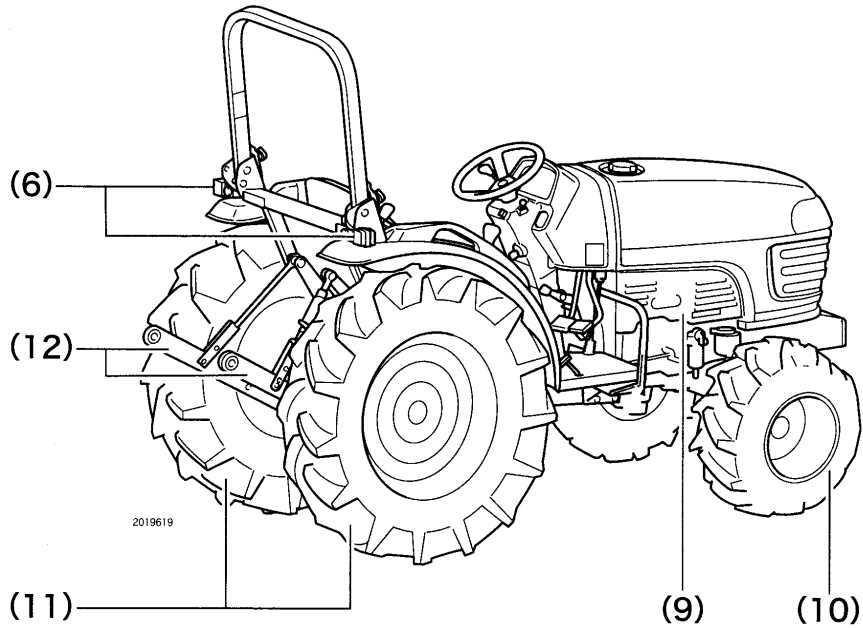
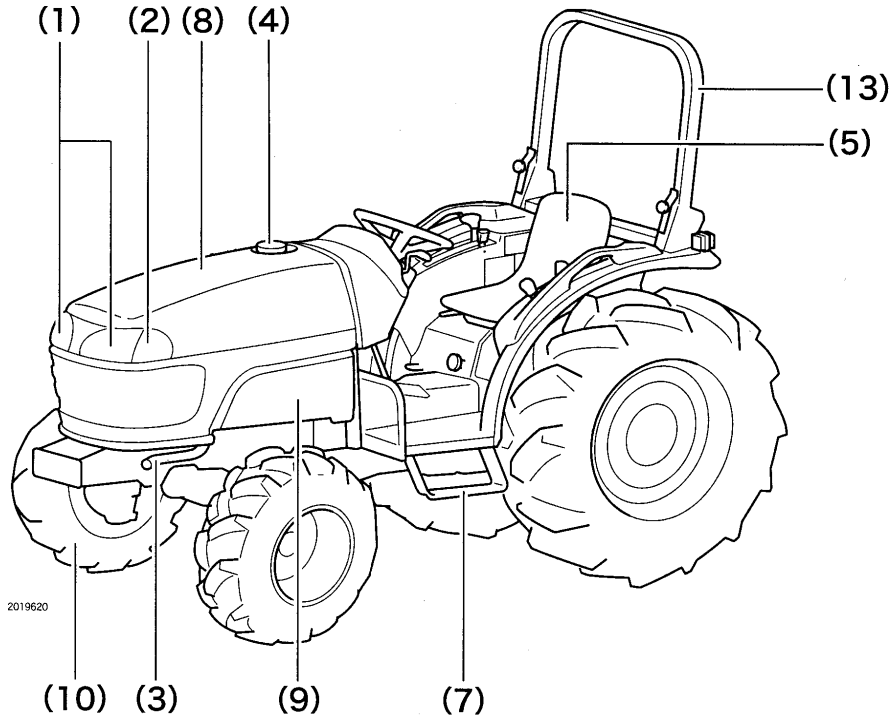

PARTS NAMES

- (1) Main switch
- (2) Accelerator lever
- (3) Accelerator pedal
- (4) Main shift lever
- (5) Range shift lever
- (6) Reverser lever
- (7) PTO shift lever

- (8) Brake pedal
- (9) Parking brake lever
- (10) Clutch pedal
- (11) Differential lock lever
- (12) Position control lever
- (13) Lever stopper
- (14) Stop & slow return valve

- (15) Head light switch
- (16) Horn button
- (17) Flasher switch
- (18) Side light switch
- (19) Seat adjust lever
- (20) Brake pedal connector
- (21) Front wheel drive lever
- (22) Seat belt (option)

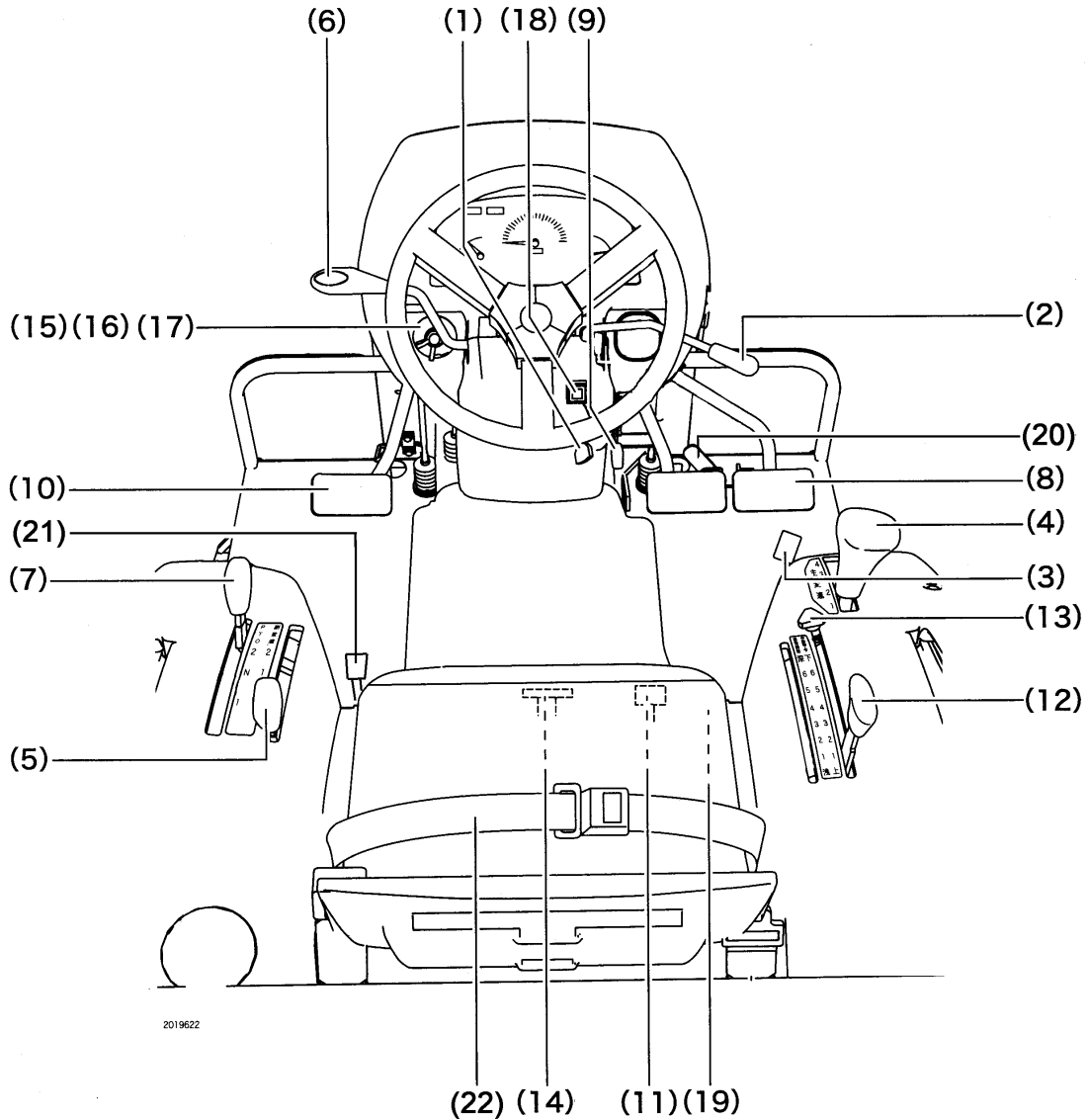

2019622

Lamps and Indicators

- | | |
|--------------------------------------|---------------------------------------|
| (1) Fuel gauge | (5) Battery charge pilot lamp |
| (2) Engine coolant temperature gauge | (6) Engine oil pressure pilot lamp |
| (3) Engine speed meter, RPM | (7) Reverser lever neutral pilot lamp |
| (4) Hour meter | |

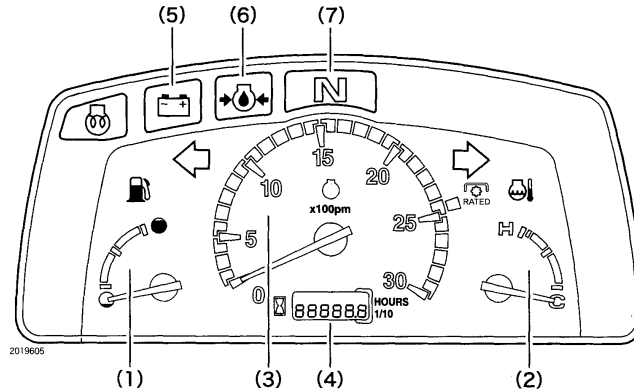

LABEL LOCATIONS

Keep the safety instructions labels clean and clearly visible for your safety. If any of them are damaged or missing, replace them with new ones.

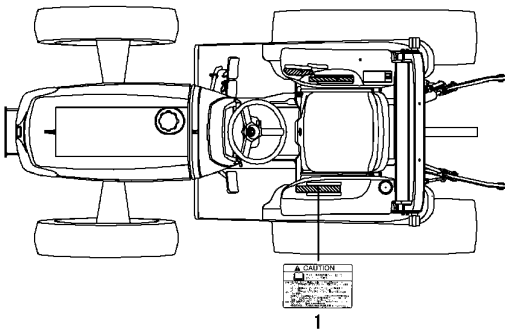

Label Model (not for sale)

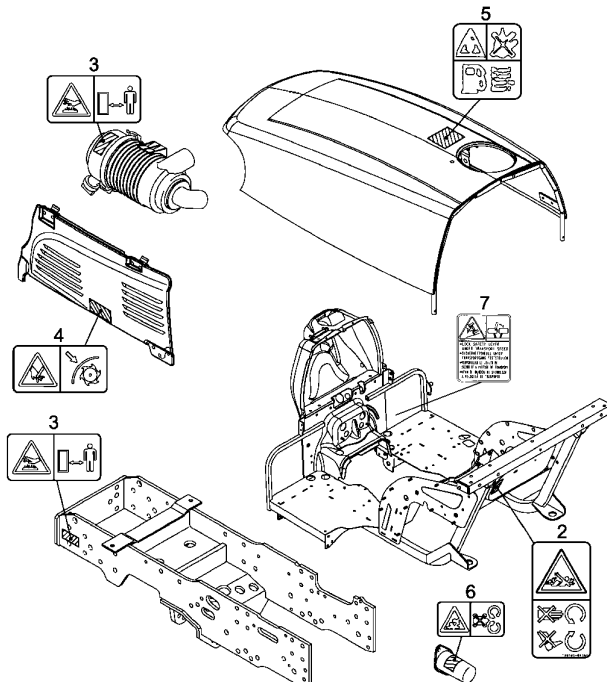
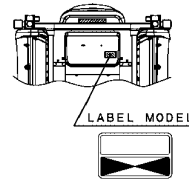

- | | |
|---------------------------------|--------|
| 1. 198122-65730 Caution label | 1 pc. |
| 2. 198163-65350 Danger label | 1 pc. |
| 3. 198163-65953 Caution label | 2 pcs. |
| 4. 198163-65940 Caution label | 2 pcs. |
| 5. 1A6150-91251 Fuel label | 1pc. |
| 6. 1A6150-93151 PTO cover label | 1 pc. |
| 7. 198163-65780 Brake label | 1 pc. |

CONTROLS

ENGINE

Main switch

The switch is used to turn on and off the engine

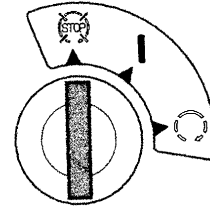

OFF



The electric current is shut off.
The engine stops. (The key can be removed.)

ON



The electric current is on. If the engine is stopped, the engine oil pressure lamp (6) and battery charge lamp (5) turn on.

START



Starter motor runs to start the engine, when range shift lever is at neutral.
Release the key when the engine starts, and the key returns to the "ON" position automatically.

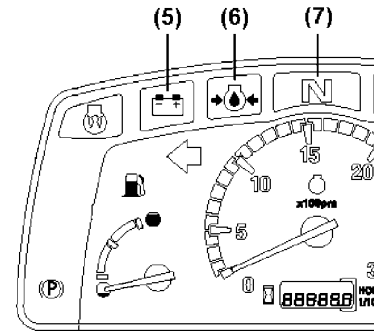

(6) Engine oil pressure lamp
(5) Battery charge lamp

Accelerator lever

The accelerator lever (A) is used to increase or decrease the engine speed or keep the engine at a constant speed.

- (A) Accelerator lever
- (SL) Slower engine speed
- (FA) Faster engine speed

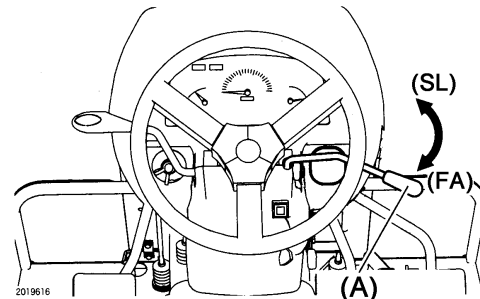

Accelerator pedal

The accelerator pedal (A) is used to increase or decrease the engine speed, mainly during travel on the road. To increase the engine speed, depress the pedal.

- (A) Accelerator pedal

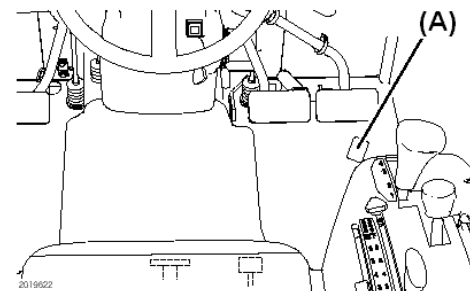

TRAVELLING, PTO RE RELATED FUNCTIONS

Main shift lever

The transmission has 4 main gear shifts.
Depress the clutch pedal fully, and move the lever to desired position.

(A) Main shift lever



IMPORTANT

Be sure the tractor stops whenever shifting. If not, it may cause damage to transmission gears.

Range shift lever

The transmission has 2 range gear shift aside from 4 main gear shifts.

(B) Range shift lever
2: High Speed range
1: Low speed range
N: Neutral



IMPORTANT

Be sure tractor stops when shifting. Do not change Range shift lever while moving.

Reverser lever

Reverser lever changes the direction of travel of the tractor, forward or reverse. Depress the clutch pedal and stop tractor whenever shift the lever.

Lift up the lever to put it in a required position.
Lever lamp lights in the N position.

(C) Reverser lever
F: Forward
N: Neutral
R: Reverse



IMPORTANT

Be sure tractor stops when shifting. Do not change Reverser lever while moving.

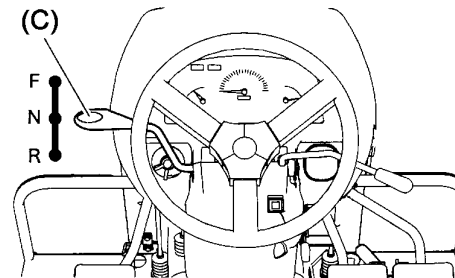
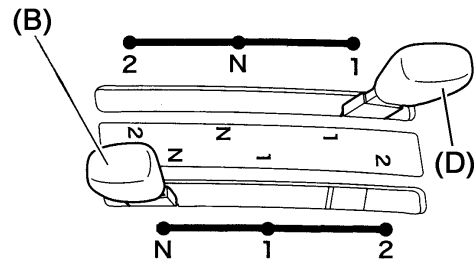
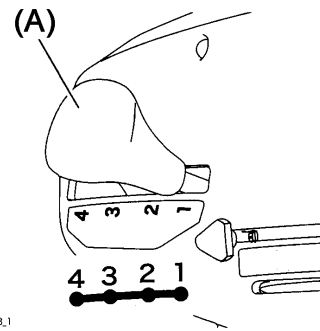

PTO shift lever

The transmission has 2 PTO speeds. To change the speed, depress the clutch pedal fully.

(D) PTO shift lever

PTO speed at engine 2,600 rpm

1 572 rpm

2 830 rpm



CAUTION

Strictly maintain the PTO speed as specified by the implement. Otherwise, the implement or transmission can be damaged and may cause an injury.

Brake pedal

Tractor has brake pedals for right and left turn independently and they can be applied separately. For a sharp turn in the field, depress the brake in which direction you want to turn. For driving on a road, never fail to connect both pedals with the connector.

To avoid unnecessary wear of brake discs, do not rest foot on the brake pedal during operation.

(A) Brake pedals

(B) Brake pedal connector



WARNING

Be sure connect the both brake pedals with the connector when driving on a load. Tractor may turn over by one-sided braking in high speed.

Parking brake lever

To apply parking brake;
Connect brake pedals, depress brake pedals and raise parking brake lever.

To release parking brake;
Depress brake pedals slightly and down parking brake lever.

(A) Parking brake lever

(B) Brake pedals

(C) Brake connector

(LK) Apply parking brake

(RS) Release parking brake



CAUTION

Be sure connect the both brake pedals with the connector when applying parking brake. If not, only left tire is locked and it may not brake tractor sufficiently.

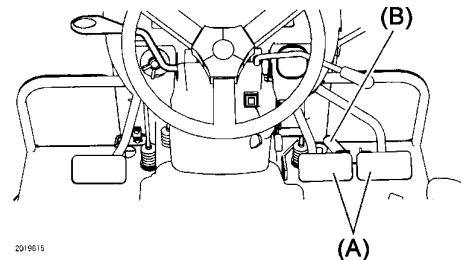
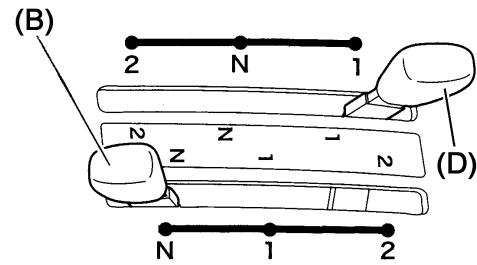

2019015

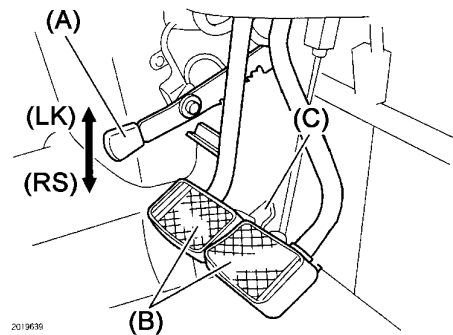

2019036

Clutch pedal

The clutch pedal transmits or cuts engine power to transmission.

To disengage the clutch, depress clutch pedal and engine power is disconnected.

To engage the clutch after depressing clutch pedal, release the pedal slowly and engine power transmits to transmission.

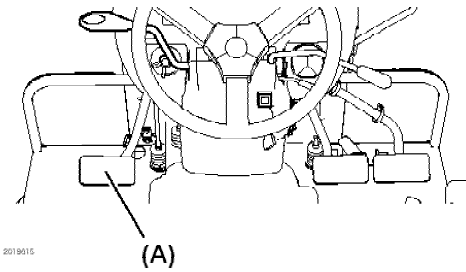

(A) Clutch pedal



IMPORTANT

Do not rest your foot on the clutch pedal while operating. It may cause premature wearing of clutch disc.

Differential gear lock pedal

A differential gear system is equipped on front and rear axles of this tractor for smooth turning.

Depressing this pedal locks rear axle differential gear box and rear wheels rotate as if right and left axles are connected. When one side rear wheel spins and the other does not rotate, depress the pedal to lock the differential gear for escaping.

To unlock differential, release the depressed pedal.

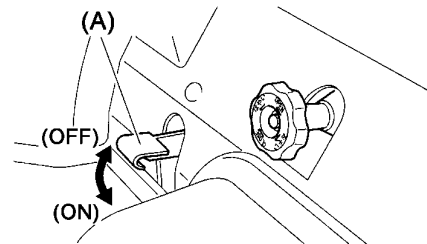

(A) Differential lock pedal
(ON) Lock differential gear
(keep depressing pedal)
(OFF) Release lock (release pedal)



IMPORTANT

When differential gear is locked, drive tractor slow speed and keep going straight. Never steer tractor while depressing the pedal.



WARNING

Never fail to unlock the differential gear after escaping from the place. Otherwise, you can not make an intended turn and an accident may result.

Front wheel drive lever

The lever engages or disengages front wheel drive. Depress clutch pedal and move the lever when tractor stops.

- (A) Front wheel drive lever
(4WD) ON: Four-wheel drive
(2WD) OFF: Two-wheel drive

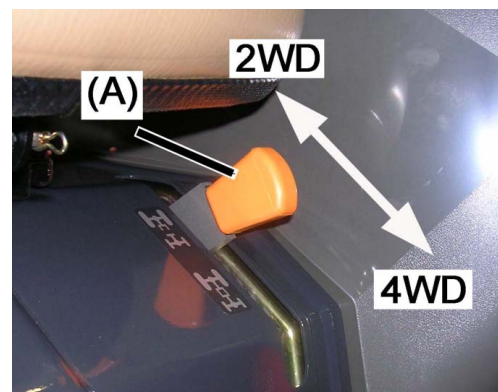

IMPORTANT

Be sure tractor stops whenever move the lever. Disengage front wheel drive when drive with high gear on a road, hard surface place or towing trailer.

HYDRAULIC SYSTEM

Position control lever

Position control lever controls height of rear hitched implement in a desired position.

Lever stopper (B) limits lowering an implement to limit the working range of the lever, or when traveling on road.

- (A) Position control lever
- (B) Lever stopper
- (UP) Raise
- (DW) Lower

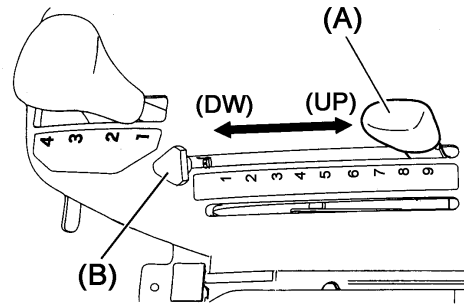

Hydraulic stop and slow return valve

Used to control the lowering speed of implement.

- (A) Hydraulic stop and slow return valve
- (OP) Open the valve and fast lowering of implement
- (CL) Slow lowering of implement and it stops hydraulic flow when turned fully.

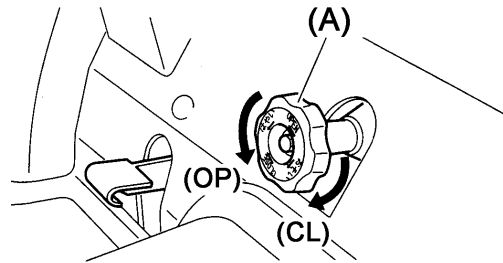

IMPORTANT

When driving on a road with rear hitched implement, open the hydraulic stop and slow return valve and fix the hydraulic control lever in raise position with stopper.

Do not operate the hydraulic control lever when the valve is fully closed. Otherwise, it may damage hydraulic parts.

ELECTRIC SYSTEM

Turn signal switch

Turn signal functions when key switch turns on.
Turn the turn signal switch anticlockwise to blink right side turn signal lamp and turn clockwise to blink left side lamp.

- (A) Turn signal switch
- (R) Right lamp blinks.
- (L) Left lamp blinks.

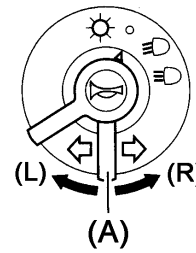

Head light switch

Headlights turn on when key switch turns on.
Turn head light switch clockwise to turn on head lights.

- (B) Light switch
- (OFF) Headlights turn off.
- (LB) Headlights turn on with low beam.
- (HB) Headlights turn on with high beam.

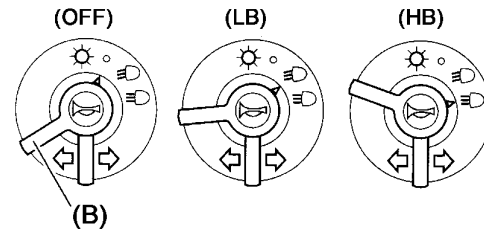

CAUTION

When there is an oncoming vehicle in night time, be sure to switch to low beam position. If keep on high beam, it may cause traffic accident.

Horn button

Horn functions when key switch turns on.
Push horn button to blow horn.

- (C) Horn button

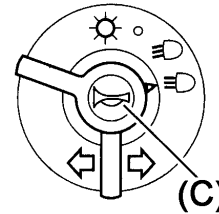

Side light switch

Side lights turn on when key switch turns on.
Push side light switch to turn on side lights and push the switch again to turn off.

- (D) Side light switch

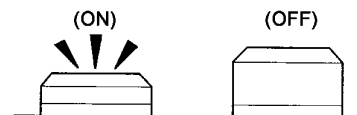
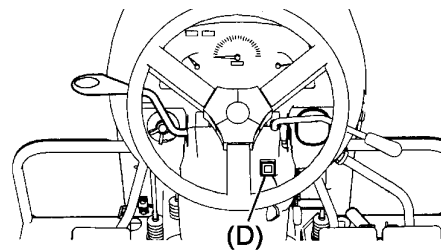

INSTRUMENT PANEL

- (1) Fuel gauge
- (2) Engine coolant temperature gauge
- (3) Tachometer
- (4) Hour meter
- (5) Battery charge pilot lamp
- (6) Engine oil pressure pilot lamp
- (7) Reverser lever neutral pilot lamp

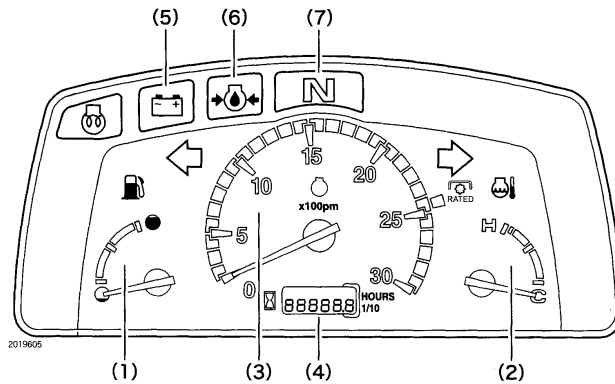

(1) Fuel gauge

It indicates fuel level remained in fuel tank when key switch turns on.

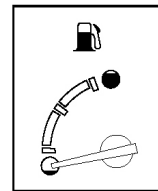

(2) Engine coolant temperature gauge

It indicates engine coolant temperature. If this pointer comes to the red zone, reduce engine speed to idling and wait for cooling down. Find out the cause and call your dealer if necessary.

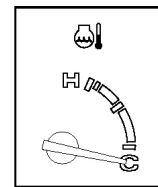

(3) Tachometer

Indicates engine speed in revolution per minute (RPM). It also indicates PTO speed 540rpm.

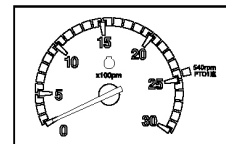

(4) Hour meter

It shows operating hour of the engine. It shows when key switch is in "ON" position. Actual working hour may be different from the meter amount due to engine speed at working.

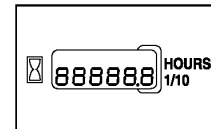

(5) Battery charge pilot lamp

This lamp lights when the key switch is in "ON" position. The charge lamp turns off when engine starts. If the lamp does not turn off at 1500rpm engine speed or higher, see your dealer.

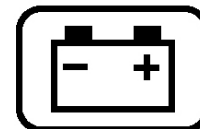

(6) Engine oil pressure pilot lamp

This lamp lights when the key switch is in "ON" position and goes off when the engine starts. If the lamp does not turn off after engine starts, stop the engine immediately and check oil level. If oil level is sufficient, see your dealer.

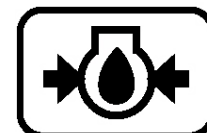

(7) Reverser lever neutral pilot lamp

The lamp lights when the reverser lever is in "N" position.



OTHERS

Seat adjust lever

It adjusts the operator's seat position in 5 steps to-and-fro.
Raise the lever and slide the seat forward or backward to desired position. Lower the lever to latch the seat.

(A) Seat adjust lever

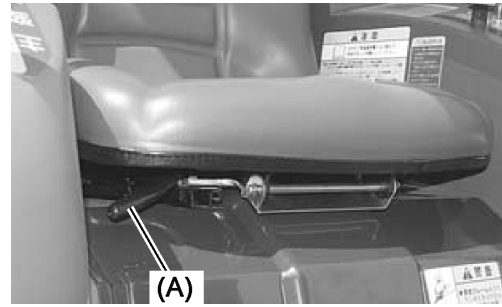

Opening bonnet

(1) Raise the lever to open bonnet.

(B) Bonnet open lever

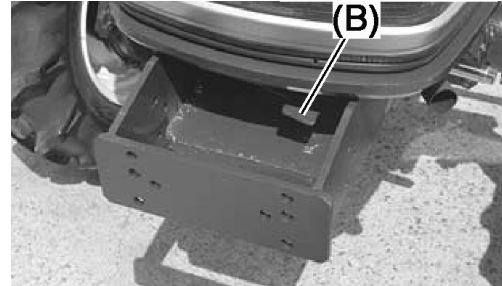

(2) Raise the bonnet and hold it with bonnet stay

(C) Bonnet stay

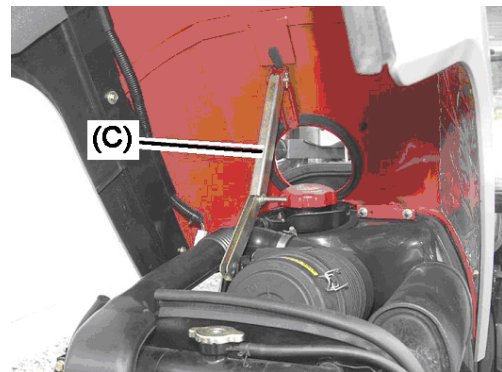

OPERATIONS

1. Pre-operation checks



DANGER

- 1) Never smoke or use bare lamps/lights during oil replenishing.
- 2) Never fill fuel oil while the engine is running or hot.
- 3) After filling fuel, be sure to cover the fuel tank with screw-top and wipe off spilled fuel. If not, a fire may be caused.
- 4) Check the fuel lines daily. Fuel leaks on a damaged fuel line.



WARNING

- 1) Whenever servicing the tractor, place it on a flat and leveled area. Be sure no traffic neither people around the tractor. Otherwise, the tractor can cause an unexpected accident.
- 2) Whenever servicing under rear hitched implement, close hydraulic stop and slow return valve (A) and place lock device or support to the implement. Otherwise the implement may fall down incidentally and it can cause injuries.

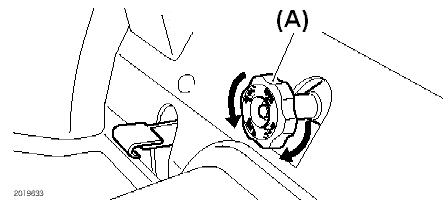

CAUTION

- 1) Never fail to stop the engine before checks or maintenance. If not, you may be trapped in a rotating part and heavily injured.
- 2) To check or service the tractor, wait until the engine and muffler are cooled down. If not, you may get burned and be injured.
- 3) Never fail to reinstall covers and parts detached for service. Otherwise, you may be trapped in the tractor and heavily injured.

For safety reasons, always check the tractor before day's work. Remove any abnormalities.

At least check the followings in order:

(1) Abnormalities in previous day

(2) Walk around the tractor to look into:

- Deformed, damaged, worn or lost exposed parts
- Air inflation pressure and wear of tires
- Loosened or lost bolts and nuts of the tire rims and disks

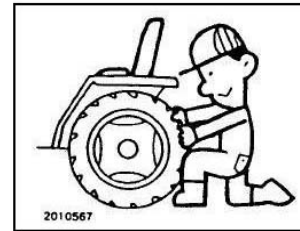

(3) Check inside the bonnet

- Engine oil level and leaks.



- Fuel oil amount, leak and damages on fuel lines.

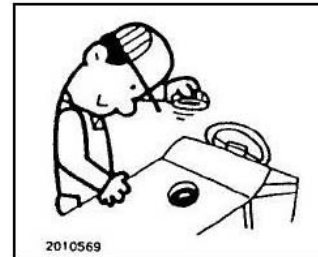

- Engine coolant level, leaks and damage on lines.

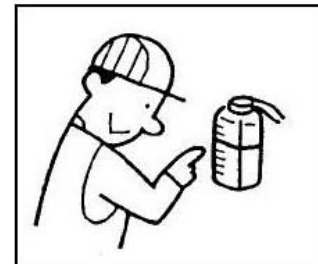

- Level of battery liquid.

This battery does not need additional replenishment of battery solution.

It is normal when the color indicated by the hydrometer on the battery is green. When it is black, charge the battery again.

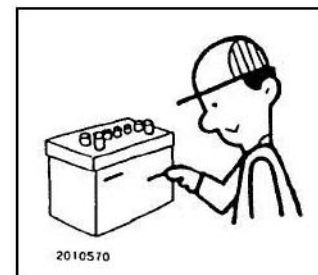

- Clogging or dirt in air filter.

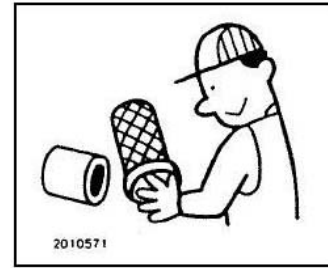

- Tension or damage of cooling fan belt.

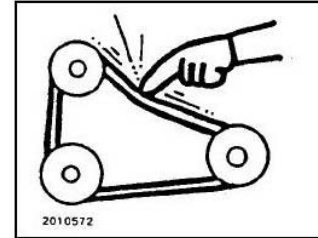

- Radiator screen, grille and engine room for dust.



- Hydraulic joint and lines for damages and loose connection.

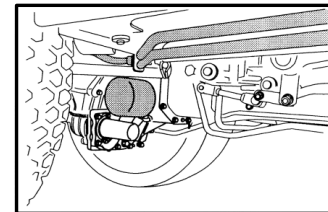

- Check electrical wirings for wear or damages of lead sheaths and loose connections.

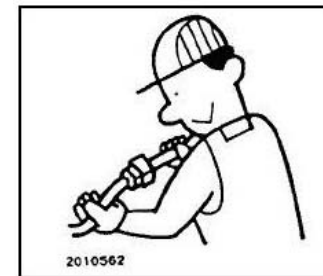

(4) Check operating system

- Play of brake pedals.

Brake pedals must have reasonable play (A) and plays of both right and left brake pedals must be equal. (30-40mm)

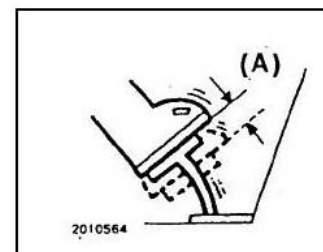

- Play of clutch pedal.

Clutch pedal must have reasonable play (A).
(15-25mm)

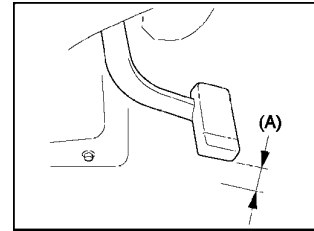

- Play of steering wheel.

Steering wheel must have reasonable play (A).
(20-50mm)

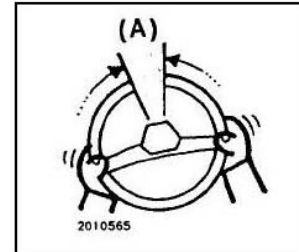

(5) Check hitched implement

- PTO Drive shaft lock pin must be in groove of PTO output and input shafts.
- Pins must be inserted in proper positions.
- Loosened bolts and nuts.
- Damaged or worn parts.
- Connection of 3-point linkage.

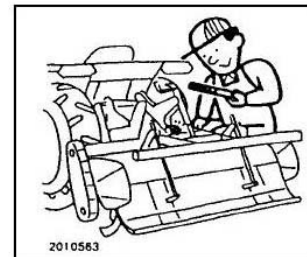

(6) Start the engine and check:

- Abnormal sound or noise.

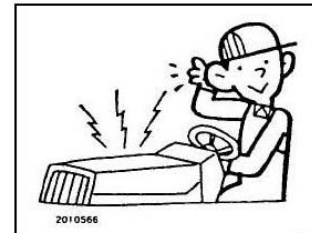

- Color and smell of exhaust gas.

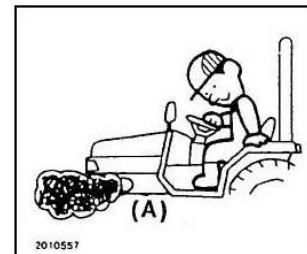

- Function of each lamp, gauge and meter



2. Brake-in (initial 50 hours)

The new tractor should be carefully operated for the first 50 hours. It will surely have an effect on the lifetime and performance of the tractor throughout the life. Pay attention to the following points in particular:

- (1) Refrain from abrupt start or brake.
- (2) Do not operate in higher speed or heavier load more than necessary. Do not operate with full load. Avoid from operation such engine speed comes down by a load or smoke while working.
- (3) Start operation after the engine is sufficiently warmed up.
- (4) Slow down on the rough road or slope.
- (5) Check the tractor after 50 hours of break-in period.

3. Before starting



WARNING

- 1) Before starting the engine, sit on the operator's seat and make sure all levers and controls are within the reach for safe operation. Negligence will cause a serious injury.
- 2) Do not run engine in a closed room. Run the engine in well-ventilated area. If you are forced to start the engine in a confined room, make sure the ventilation is proper. Exhaust gas is poisonous and it can lead to death.



CAUTION

- 1) Before and after operation, never fail to check and service the tractor. Particular check will be required at brake pedals, controls, steering devices and tire rim fitting bolts. Negligence can cause a heavy injury or accident to the tractor and the human.
- 2) Set the parking brake during the warm-up operation. Otherwise the tractor may abruptly start to run.

4. Start and stop

4-1. Start and stop engine

Start engine



IMPORTANT

- 1) Do not keep the engine starter motor running for more than 10 seconds. If the engine does not start, keep it cool for one minute before retry. Then, execute steps (3) - (4).
- 2) Never turn the main switch to start position while engine is running.

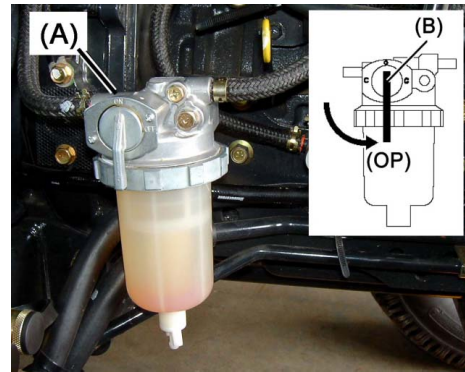

(A) Water separator

(B) Fuel cock

(OP) Open

- (1) Open the fuel cock (A).
- (2) Put the reversser lever and PTO shift lever in the "N" position.
- (3) Set position control lever in the LOW position. Make sure that the implement is lowered.
- (4) Pull accelerator lever to higher speed position (FA).
- (5) Insert key and turn it to "ON" position.

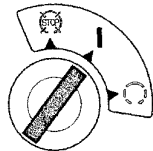

Check pilot lamps on meter panel;

- (5) Battery charge pilot lamp is on.
- (6) Engine oil pressure pilot lamp is on.
- (7) Reverser lever neutral lamp is on.

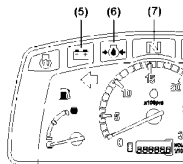

- (6) Turn key switch to "START" position.
- (7) As engine starts, immediately release key switch and it goes back to "ON" position automatically.

When engine starts, battery charge and engine pressure pilot lamps turn off.

- (8) Warm up the engine by running under no-load at 1500 rpm for 5 minutes approximately. Especially if the temperature is below 0°C, a warm up of at least 10 minutes is required.

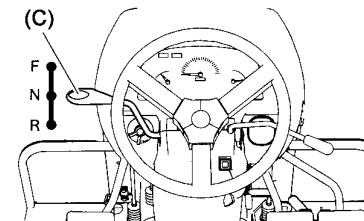

(C) Reverser lever

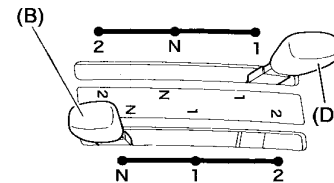

(D) PTO shift lever

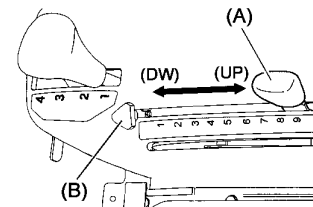

(A) Position control lever

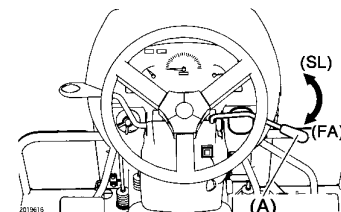

(A) Accelerator lever

Stop engine

- (1) Push accelerator lever (A) toward (a) to decrease engine speeds.
- (2) Turn key switch to "OFF" position.
- (3) See main shift lever, range shift lever, reverser lever and PTO shift lever are in neutral positions.

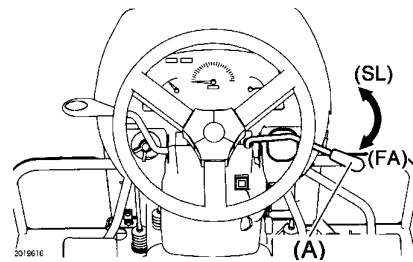

(A) Accelerator lever (SL) Slow speed



IMPORTANT

Sudden stop of hot engine may cause engine overheating. Prior to stop engine, keep engine running at 1200 - 1500 rpm for about 2 minutes to cool down.

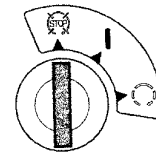

4-2. Start, gear shifting and stop tractor

Start tractor

- (1) Be sure right and left brake pedals are connected by connector.
- (2) Set engine speed about 1500 rpm.

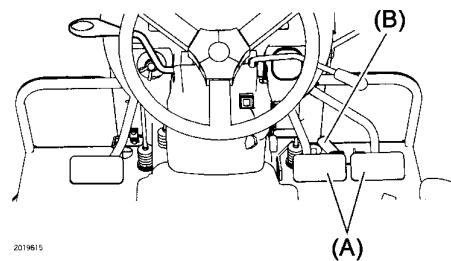

(A) Brake pedals (B) Connector

- (3) Move position control lever backward and raise rear hitch implement.

- (A) Position control lever
- (UP) Raise rear hitch implement

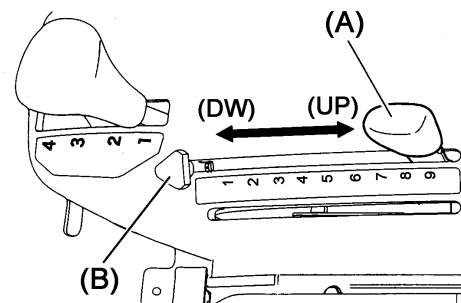

- (4) Depress clutch pedal fully and shift main shift lever and range shift lever to desired speed.

- (A) Main shift lever
- (B) Range shift lever

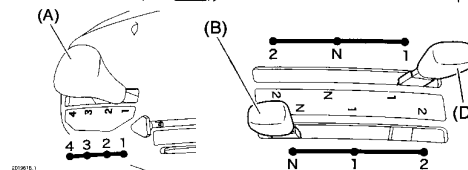

- (5) Shift reverser lever to forward or reverse.
- (6) Release clutch pedal gradually and tractor starts.



IMPORTANT

- 1) Never rest your foot on clutch pedal while operating. It will cause pre-mature wearing of clutch disc.
- 2) Never fail to lock the parking brake when you leave the tractor.
- 3) Look around the tractor to start.

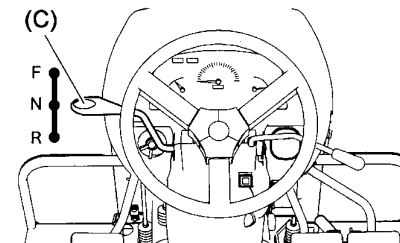

(C) Reverser lever (N) Neutral (F) Forward (R) Reverse

Gear shifting

- (1) Main shift lever
Depress clutch pedal fully and shift lever to desired speed after tractor stops.
- (2) Range shift lever
Depress clutch pedal fully and shift reverser lever to "N" after tractor stops.
Keep depressing clutch pedal and shift range shift lever to desired speed.
- (3) Reverser lever
Depress clutch pedal fully and shift reverser lever to (F) or (R) after tractor stops.



IMPORTANT

Never shift main, range and reverser lever while tractor is moving. If not, it may cause breakage of transmission inner gear.

Stop tractor

- (1) Push accelerator lever forward to reduce speed.
- (2) Depress clutch pedal and brake pedals at the same time.
- (3) Shift range shift, reverser and PTO shift levers to "N" position.
- (4) Make sure brake pedals are connected with connector and apply parking brake (lock brake pedal with parking brake lever).
- (5) Lower rear hitch implement if it is attached.
- (6) Turn key switch to "OFF" position and remove the key.

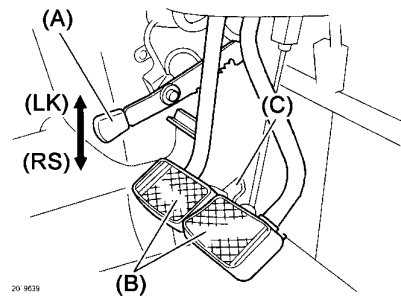

(A) Parking brake lever (B) Brake pedals
(C) Connector
(LK) Lock (RS) Release

5. Driving on a road



WARNING

- 1) Make sure that left and right brake pedals are connected whenever traveling on a road or cross a farm ridge. One-sided braking effect will roll over the tractor or result in a sharp turn.
- 2) Follow the traffic regulations and rules in your place when running on a road. Strictly one operator only on tractor.



CAUTION

Remove an implement when traveling on a road. If not, an accident may result in. Put the PTO shift lever in "N".

- (1) Connect right and left brake.
- (2) Shift PTO shift lever to "N" position.
- (3) Open hydraulic stop and slow return valve fully.

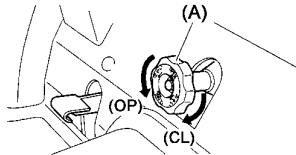

(A) Hydraulic stop and slow return valve
(OP) Open valve

- (4) Move position control lever up and lock it with stopper.



CAUTION

Make sure that position control lever is held when traveling on a road. If not, hand may touch position control lever incidentally and implement would go down. It may cause an accident and injury.



IMPORTANT

- 1) Adjust the traveling speed with the foot accelerator pedal.
- 2) When you turn tractor or change traveling course, notify others by turning signal lamp.
- 3) When there is on-coming vehicle in night time, make headlight be low beam.
- 4) Disengage front wheel drive except in special case.

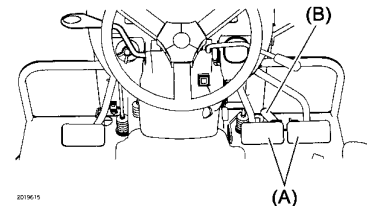

(A) Brake pedals (B) Connector

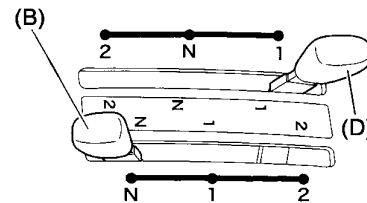

(D) PTO shift lever

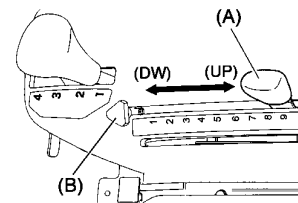

(A) Position control lever (B) Stopper
(UP) Raise rear hitched implement

6. Driving on a slope



WARNING

- 1) Select a correct speed before approaching a slope. Never change shift levers on a slope. Tractor may coast down unintentionally.
- 2) Never travel on the slope with reverser lever, main shift lever or range shift lever set in "N" position.
- 3) Never depress the clutch pedal on a slope. Tractor may coast down unintentionally and it may cause an accident.
- 4) To start on an up-slope, shift gears to low speed and engage clutch slowly and carefully. Abrupt start will jump up the front wheel.
- 5) Do not park tractor on a slope as much as possible. If it is required, apply parking brake and put wheel block to avoid from coasting down.

(1) Select slow speed before going into a slope.

(2) Travel slowly on a slope.

(3) Apply engine brake on a down-slope.

7. Driving in and out of a field



WARNING

- 1) Be sure to connect left and right brake pedals with connector. One-sided brake results in causing a roll over.
- 2) In case field ridge is high, use a gangplank with sufficient strength. Lower an implement and go through ridge in slow speed.
- 3) If a way to field is steep slope, go up with a reverse gear.

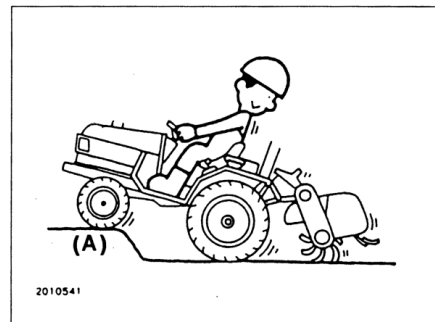

(A) Ridge

8. Setting adequate speed

8 forward speeds and 8 reverse speeds are available by the combination of main, range and reverser shift levers. Select adequate speed for works.

Suggested operation by working speed.

Shift	Main shift	Range shift	Speed (km/hr)		Operation
			EF312T	EF352T	
F1	1	1	1.26	1.32	Rotary
F2	2		1.83	1.90	
F3	3		2.61	2.72	
F4	4		3.94	4.09	Spreader
F5	1	2	6.58	6.85	Plow
F6	2		9.5	9.88	
F7	3		13.60	14.14	Traveling with the trailer
F8	4		20.49	21.31	

(At engine speed: 2500rpm/EF312T, 2600rpm/EF352T)

9. Turning in a field



WARNING

Release foot from differential lock pedal to release differential gear before turning. Otherwise, tractor cannot turn when it is required and an accident may result.

Unlatch brake pedal connector in a field.

- (1) Reduce the engine speed.
- (2) Move position control lever rearward to raise the implement
- (3) Turn steering wheel to desired direction and depress brake pedal in the same direction of steering wheel turn at the same time.

ex:

When you turn steering wheel clockwise to turn right, depress right side brake at the same time.

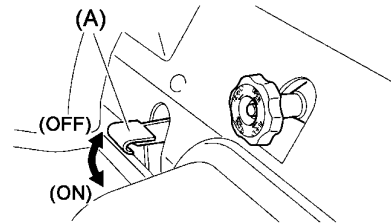

(A) Differential lock pedal (OFF) Release

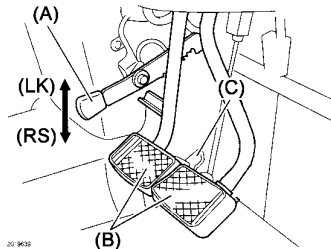

(B) Brake pedal
(C) Brake pedal connector

10. Differential gear lock



WARNING

- 1) Release differential gear lock before making a turn. Otherwise, tractor can not turn and an accident will result.
- 2) Never depress differential lock pedal while traveling on a road. If you depress the pedal, you could not steer and may cause an accident and injury.

Differential gear lock system is effective when one side rear wheel is locked and the other tire slips. When differential gear is locked, right and left rear axle rotate as if both axles are connected. It is easier to go out from muddy and slippery place.

Operation

- (1) Lower engine speed.
- (2) Depress differential lock pedal.
- (3) Release the pedal to unlock differential gear lock.
If it is difficult to unlock the differential system, depress clutch pedal or step on right and left brake pedal alternately.

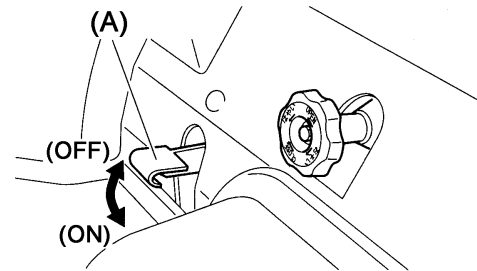

(A) Differential lock pedal
(OFF) Release lock (Release pedal)
(ON) Apply differential lock (Depress pedal)



IMPORTANT

- 1) Never turn steering wheel while differential lock pedal is depressed.
- 2) Do not use lowest speed shift gear.

11. Loading and unloading



DANGER

- 1) Never steer tractor on loading bridge while loading into or unloading from cargo truck. Drive tractor in slowest speed. If not, loss of control can result in injure or damage the tractor.
- 2) Never depress clutch pedal on loading bridge. Tractor may coast down and cause injury.
- 3) Latch brake pedals. If not, tractor may steer unintentionally when depress one side brake pedal only. Tractor may fall down from loading bridge and may cause injury.
- 4) Never stand against loading bridge. Be away from loading work.

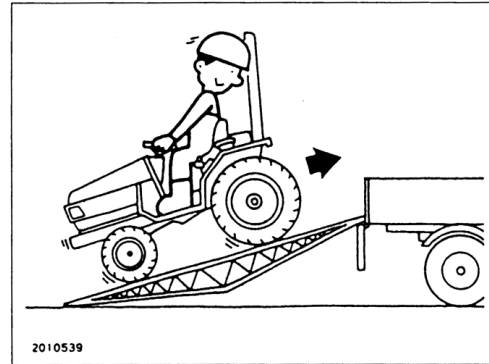

WARNING

- 1) Loading bridge must be of sufficient size, strength and with anti-slip surface. Length of the loading bridge must be longer than 4-time of floor deck height. Fix loading bridge with floor deck of truck.
- 2) Reverse tractor for loading into truck, go forward for unloading. Shift gear to slow speed.
- 3) Tie tractor firmly to truck with a rope of sufficient strength.

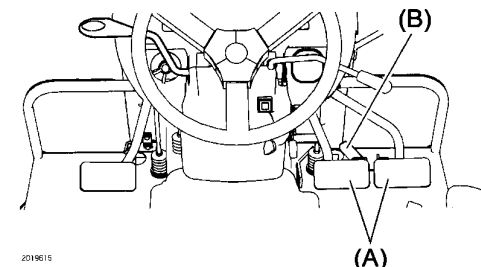

(A) Brake pedal

(B) Connector

(1) Loading truck preparation

Park the truck on a flat and leveled place where is wide enough and no traffic expected.
Stop truck engine and apply the parking brake.
Block wheels of the truck.

(2) Loading

Latch right and left brake pedals with connector.
Shift gear levers to slow speed.
Slow down engine speed and reverse tractor to load.
Make sure tractor is aligned with loading bridge.

[If engine stops on loading bridge]
Depress brake pedal immediately and gradually release brake pedal to go down slowly.
Start engine and load again.

(3) On the floor deck

Apply parking brake of tractor.
Stop tractor engine.
Lower rear hitched implement if any.
Tie tractor with truck

(4) Unloading

Untie tractor.
Start engine and shift gears to low speed.
Raise rear hitched implement if any.
Start tractor forward in slow speed. Do not steer.

12. Adjusting wheel tread

Adjust the tractor rear wheel tread according to the type of crops and field preparation.
Apply a wide wheel tread for works on a slope or for a traction work.

- (1) Apply parking brake and put tire stoppers to front wheels and jack up tractor body to raise rear wheels.
- (2) To adjust the wheel tread, exchange left and right tires.



IMPORTANT

Front tire tread is not adjustable.

Tire tread

Tire	Size (ply rate)	Standard tread (mm)	Wide tread (mm)
Front	7-14 (4)	1000	N.A.
Rear	11.2-24 (4)	1025	1105

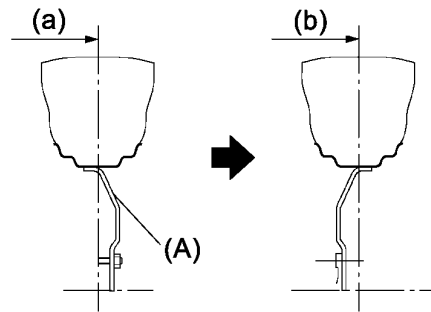

- (A) Wheel disc
(a) Standard tread
(b) Max. tread

13. Hydraulic power take off

Single action cylinder

In case of single action cylinder, remove the hydraulic outlet plug (A) on right side of control valve, and connect hydraulic hose from cylinder of implement.

<Operation>

- (1) Set the position control lever in the lower position.
- (2) Fasten the hydraulic stop/slow return valve (B) at fully clockwise position.
- (3) Operate the position control lever to move the implement.

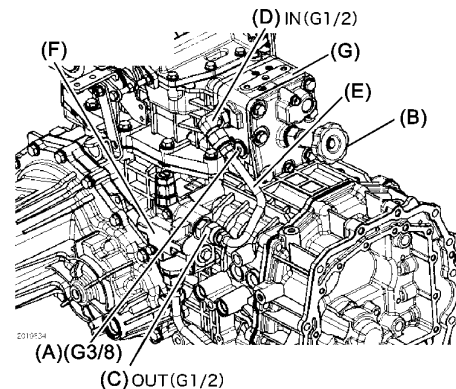

- (A) Hydraulic outlet (single action)
(B) Hydraulic stop/slow return valve
(C) Hydraulic outlet (double action, out)
(D) Hydraulic outlet (double action, in)
(E) High pressure pipe
(F) Relief valve
(G) Hydraulic control valve

Double action cylinder

<Connection>

- (1) Remove operator's seat.
- (2) Remove the dust cover under the seat.
- (3) Remove the high pressure pipe (E).
- (4) Connect hydraulic hose to port (C) that the oil goes to SCV and connect hose to port (D) that oil comes back from SCV.
- (5) Install the dust cover and the seat.

Keep the high pressure pipe for the time when removing SCV.

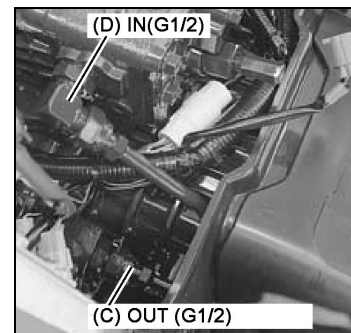

14. Using 3-point hitch

3-point rear hitch type is Category 1.

Top link

Adjust length of top link (A) to implement. Loosen lock nut turn turnbuckle on top link and adjust the length.

Follow instructions of implements.

Lift link and lower link

Set lower link hole and lift link hole according to implement and work.

Lower link hole	Lift link hole	Remarks
(1)	Refer to the instruction of implement	Standard 3-P
(2)	(5)	Special 3-P

Never use the combination of hole (2) and hole (3).

Check chain

Check chain adjustment.

- (1) For implements such as a plough, harrow and subsoil plow, adjust check chains so as an implement could be swung about 5 cm. Make sure that lower link does not hit tire.
- (2) For implements such as a rotary tiller and mower, adjust check chains so as implement does not swing, but not too tight.



IMPORTANT

When an implement is not attached to tractor, tie lower links to avoid from hitting rear tire while driving.

15. Drawbar hitch

Use Drawbar when towing a trailer.

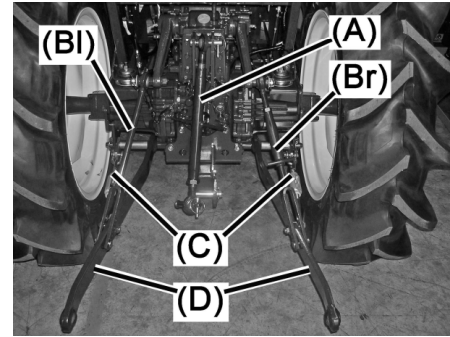

(A) Top link (C) Lower link
(B) Lift link (D) Check chain

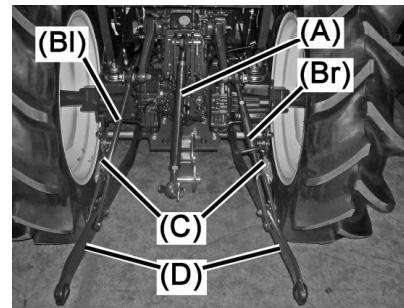
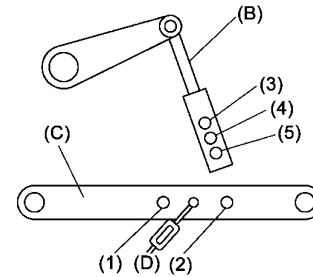

(C) Check chain

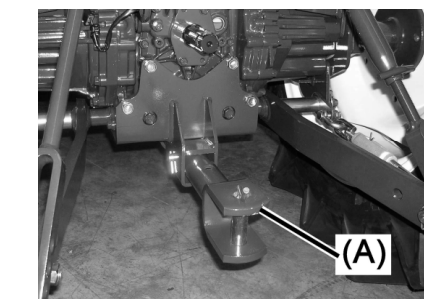
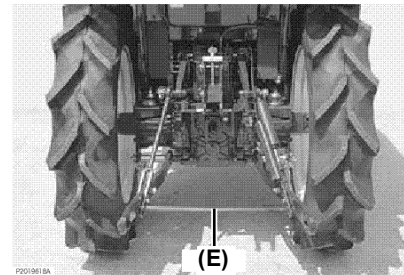

(A) Drawbar

16. General precautions on attaching and detaching an implement



WARNING

- 1) When moving the tractor to attach an implement, never allow a person between the tractor and the implement. Always keep the moving speed in the lowest.
- 2) Attach or detach an implement on a flat and leveled ground in a safe way. Use lights during nighttime work.
- 3) When leaving the tractor for attaching or detaching an implement, never fail to set the parking brake and stop the engine.
- 4) Be sure to use the tractor's original drawbar hitch for towing work.
- 5) Attaching an implement results in a considerable longer overall length. Pay attention to bystanders or constructions nearby when driving tractor.
- 6) Never place objects on the tractor or try to use your own body as counterbalance the tractor. Use only authorized genuine balance weight or implement.
- 7) Maximum counter weight on front bracket and rear wheel is;
Front bracket: 150 kgs
Rear wheel weight: 100kgs for each wheel
- 8) Add the front weight so that the weight of the front axle may always become 20% or more of the total weight.
- 9) Install a cover on PTO shaft when it is not used. Otherwise, it may cause injury.
- 10) For safe and correct operations, read the instruction manual for an implement.

Negligence of safety precautions causes a serious injury or death.

17. Power steering

This tractor is equipped with hydrostatic powered steering system.

The hydraulic power assists steering works only when the engine is running. The steering wheel may become a little heavier at low engine speeds



WARNING

Whenever the engine is running, steering wheel turns with very light force. Avoid from abrupt steering or it may cause uncontrollable steering and may cause accident or injury.



IMPORTANT

- 1) When the steering wheel is turned to its end, the relief valve works and chirp sound comes out. If relief valve works in a short time, it is not a problem but long time work of valve may cause trouble in the hydraulic system.
- 2) When tractor dose not run, do not turn steering wheel as much as possible. It may cause damage on tires or rims.

18. Safety frame (ROPS) (Optional equipment)

The safety frame (ROPS, Roll Over Protect Structure) is designed to protect operator from an accident such overturn. It is suggested to install safety frame for safety operation. Please contact Yanmar tractor dealer nearby.

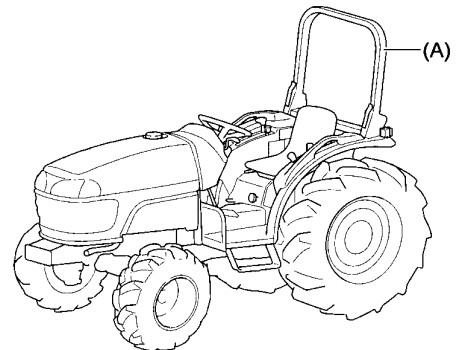

(A) Safety frame (Optional equipment)



WARNING

- 1) Do not modify the safety frame. Safety factor can be lost.
- 2) Be sure the safety frame is installed and tightened firmly. Check loosened bolt and nut and tightened if loosened.
- 3) Damaged frame should be replaced as a complete set. Partial repair may lead loss of safety level and it may cause serious injury or death.

19. Tightening torque of bolts and nuts

Bolts and nuts being used on this tractor are of grade "7T" unless otherwise grade is not specified in this manual.

Tighten torques show on right table.

Bolt size (mm)	Grade 7T	
	(N·m)	(kgf-m)
M6	8 - 12	0.8 - 1.2
M8	23 - 30	2.3 - 3.0
M10	44 - 59	4.5 - 6.0
M12	78 - 98	8.0 - 10.0
M14	118 - 147	12.0 - 15.0
M16	167 - 206	17.0 - 21.0
M18	235 - 284	24.0 - 29.0
M20	323 - 402	33.0 - 41.0

OPENING BONNET AND SIDE COVER

Bonnet

Opening

- (1) Pull up the bonnet lever (A) to release the bonnet lock.
- (2) Lift the bonnet until the bonnet stand (B) is locked. Make sure the bonnet stand works properly.

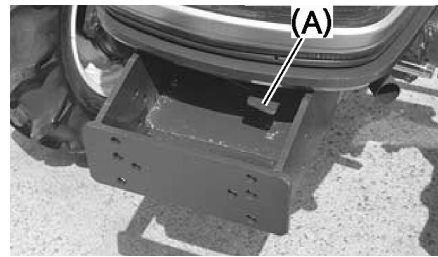

(A) Bonnet lever

Closing

- (1) Lift the bonnet a little and pull bonnet stand forward. Lower bonnet a click sound comes.
- (2) Make sure the bonnet is locked securely after closing the bonnet.

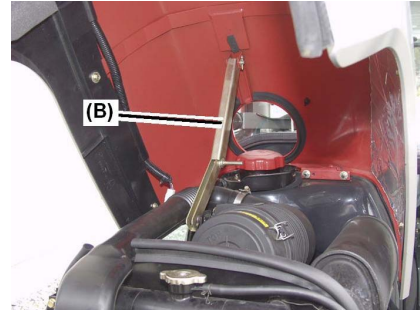

(B) Bonnet stand

Side covers

Opening

- (1) Open the bonnet.
- (2) Pull upper part of side cover sideway and pull up side cover.

Closing

Follow reverse sequence of opening procedure.

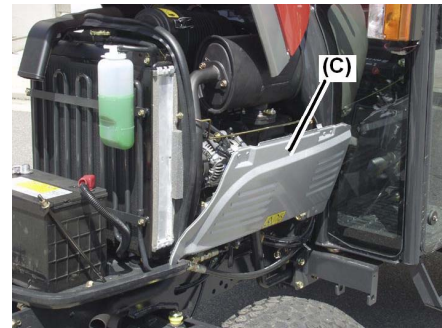

(C) Side cover

AFTER OPERATION

1. After operation

Clean thoroughly the tractor after daily operation to keep it in good condition for a long time. In particular, clean lower and front areas before storing it.

Wash the tractor with water and wipe off. Lubricate moving parts and sliding parts. Apply grease to all grease nipples especially after working in wet field.



IMPORTANT

Do not splash or spray water on electrical parts. Water can cause a trouble in the electrical system.

2. Care for long period of storage



WARNING

When tractor is stored for a long time, remove the battery and main key. Deterioration of electric wire or rat biting may cause electric leakage and may start a fire.

When storing for a long time, take following procedures.

- (1) Turn off all switches and remove the main switch key.
- (2) Place the tractor in a well ventilated place and remove counterbalance weights or other implements.
- (3) Coat exposed metallic parts with anti-rusting oils, engine oils or greases.
- (4) Fill up the fuel tank with fuel. Otherwise, moisture will develop in the tank and cause rust. Close cock of water separator and fuel filter.
- (5) Charge the battery fully. Remove the battery from the tractor and keep it in a dark and cool place. If the battery is kept on the tractor, be sure to disconnect the ground line (negative lead).
- (6) Drain coolant from the engine.



IMPORTANT

The battery is subject to self-discharge. Charge it fully at least once a month.

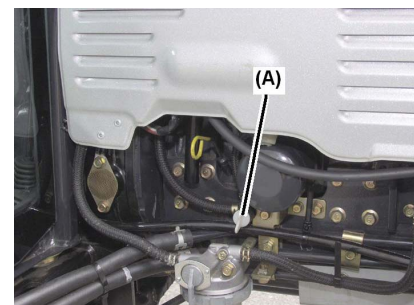
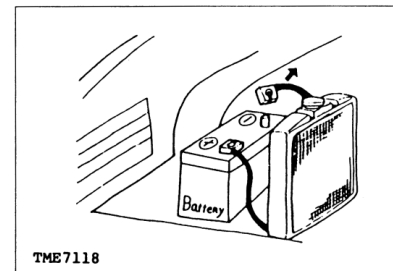
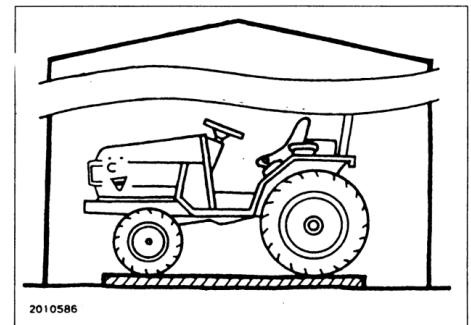
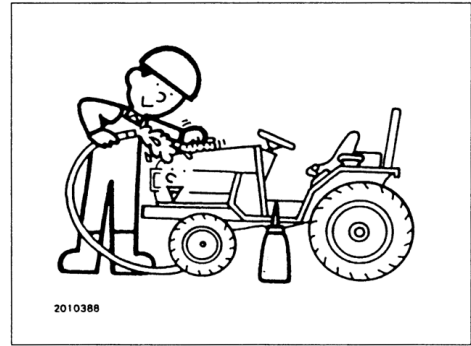

(A) Coolant drain plug

(7) Depress clutch pedal and latch pedal lock.



CAUTION

If clutch pedal is not locked for storage, clutch disc may rust and stick to engine flywheel. Tractor may start unintentionally when start engine and may cause injury.

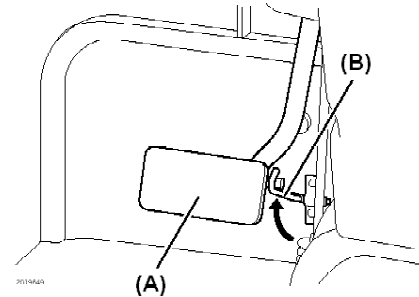

(A) Clutch pedal
(B) Clutch pedal lock

(8) Put blocks or stands under tractor to take weight off tires. Protect tires from heat and sunlight.

(9) Inflate the front and rear tires with air to the normal pressure.

	Size, (ply number)	kg/cm ² (kPa)
Front tire	7-14, (4)	1.8 (180)
Rear tire	11.2-24, (4)	1.2 (120)



PERIODICAL SERVICE



WARNING

- 1) Stop the engine before servicing.
- 2) Service tractor on a flat and leveled place, free from normal traffic and bystanders.
- 3) Fix the tractor wheels not to move.



CAUTION

Check periodically fuel lines and power steering hoses for damages, wearing and loose connections. If there is damage, wearing or loose, be sure to see your dealer. Otherwise an accident or injury can result.

Periodic inspection and maintenance in off-season will ensure the preferable conditions of your tractor. To keep your tractor working in good conditions, ask your service dealer for a regular inspection.

It is recommended to replace fuel pipes, rubber hoses, and electrical wires every two years at least.

1. Check intervals

x: Check required

CHECK ITEMS	50 h	100h	150h	200h	250h	300h	350h	400h	450h	500h	550h	600h
Engine lubrication oil	Replace	Replace		Replace		Replace		Replace		Replace		Replace
Engine oil element	Replace					Replace						Replace
Transmission oil	Replace	X	X	X	X	Replace	X	X	X	X	X	Replace
Transmission oil filter	Replace					Replace						Replace
Fuel filter						Replace						Replace
Water separator strainer	Drain	Drain	Drain	Drain	Drain	Clean	Drain	Drain	Drain	Drain	Drain	Clean
Radiator fin	Clean	Clean	Clean	Clean	Clean	Clean	Clean	Clean	Clean	Clean	Clean	Clean
Cooling water (Replace)	Check before every work (Replacing every year)											
Front axle oil	Replace	X	X	X	X	Replace	X	X	X	X	X	Replace
Air cleaner element	X	X	X	X	X	X	X	Replace	X	X	X	X
Radiator screen	Clean before every work											
Battery hydrometer	X	X	X	X	X	X	X	X	X	X	X	X
Fuel piping, connections	X	X	X	X	X	X	X	X	X	X	X	X
Rubber hoses (Power steering)	X	X	X	X	X	X	X	X	X	X	X	X
Radiator hoses	Replace hoses every two years											
Hydraulic rubber hoses	Replace hoses every two years											
Fuel pipe, electric wires	Replace pipes and wires every two years											
Electric wiring, connections	X	X	X	X	X	X	X	X	X	X	X	X
Grease-up	X	X	X	X	X	X	X	X	X	X	X	X
Fastening of steering wheel fix nut		X		X		X		X		X		X
Important nuts and bolts	X	X		X		X		X		X		X
Cooling fan belt	X	X		X		X		X		X		X
Engine breather pipe	X	X	X	X	X	X	X	X	X	X	X	X
Engine crank case												X
Clearance of exhaust valve												X
Fuel injection valve												X
Generator, start motor	X	X				X				X		
Hydraulic system	X	X				X				X		

Check at the first 50 operating hours or after first one-year operation.

2. Oil and grease

Oil, Grease	Type
Fuel oil	Diesel fuels; grade 1-D or 2-D defined by ASTM Designation D975 (see the next chart)
Engine oil	API grade CD or better grade, SAE #30 or #40
Transmission and Hydraulic system oil	Yanmar TF-500A Transmission fluid or equivalent
Front axle	Gear oil SAE #90
Grease	Multipurpose type (suggested with 3-5% molybdenum disulfide)

3. Capacity of oils and water

(Unit: liters)

		EF312T	EF352T
Fuel oil		28	28
Cooling water	Radiator	3.7	3.7
	Sub-tank	0.4	0.4
Engine oil		4.7	4.7
Transmission and hydraulic system oil		25	25
Front axle oil		5.7	5.7
Power steering oil		Common uses of transmission oil	

All capacities are approximate.

4. Equivalent oil to transmission fluid TF500A

Supplier	Brand name
Mobil	Mobil Fluid 425
Castrol	Agricastrol MP
John Deere	J14A, J20B
ESSO	Torque Fluid 56
Shell	Shell Tellus Oil 32 or 37

*Oil must not be mixed with other brand.

5. Fuel system

5-1. Fuel



WARNING

- 1) Use diesel fuel only.
 - 2) Do not refill when engine is hot.
 - 3) Keep away sparks, flames and cigarettes while handling fuel.
 - 4) Wipe off spilled fuel.
-
- (1) Choose the correct diesel fuel. Use either Grade No. 1-D or Grade No. 2-D fuels, as defined by ASTM Designation D975 for diesel fuels, or its equivalent in materials and quality.
 - (2) Fill fuel tank at end of each day's operation. This reduces deposit of water in fuel tank.
 - (3) Proper fuel storage is important. Keep all dirt, water, and other contaminants out of fuel. Avoid from storing fuel for long time.

5-2. Refill fuel



DANGER

- 1) Never smoke or use a bare lamp/light during filling fuel.
- 2) After filling fuel, be sure to put the fuel tank cap back firmly and clean off spilled fuel.
- 3) Fill fuel after the engine stops and becomes cool. A fire can result.

Turn key switch to ON position to check fuel amount in the tank. Fuel gauge shows amount that fuel remained in the tank. Refill fuel as required.

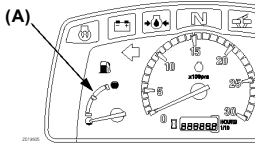

(A) Fuel gauge

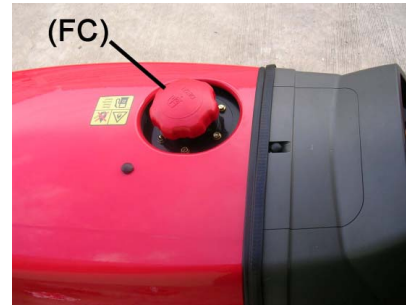
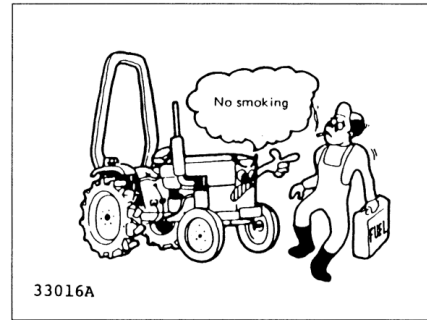

(FC) Fuel tank cap

5-3. Drain and cleaning of water separator

Water separator removes water in fuel. When water is deposited in the bowl of the separator, drain it.

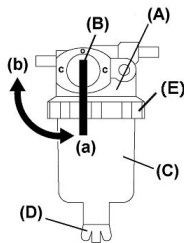

- (A) Water separator
- (B) Fuel cock
- (C) Strainer
- (D) Drain cock
- (E) Retaining ring
- (a) Open (b) Close

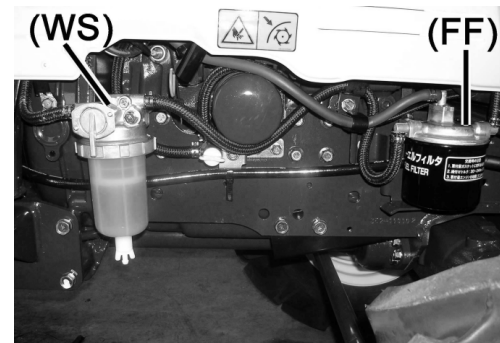

(WS) Water separator

- (1) Turn the fuel cock to close position.
- (2) Loosen the drain cock on the bottom of the water separator and drain water. Do not remove drain cock.
- (3) If water is dirty, loosen retaining ring and remove the bawl. Clean inside of bawl and strainer.
- (4) Tighten drain cock or reinstall the removed bawl, strainer to the original position.
- (5) Open fuel cock and see water separator is filled up with fuel. Crank engine for about 5 – 10 seconds to bleed the air from the fuel and start engine.

5-4. Replacing fuel filter (Cartridge type)

Replace
Every 300 hours

- (1) Apply lubricating oil to the rubber ring of fuel filter.
- (2) Install it surely.



IMPORTANT

Use a genuine filter. Engine fuel injector has very fine hole. If the filtering efficiency is low, it may cause a trouble in engine.

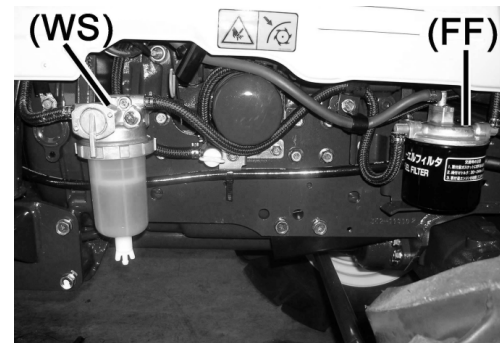

(FF) Fuel filter

6. Oil and filter

6-1. Engine oil and filter



DANGER

Never refill or add oil while the engine is hot or running. A fire may occur or you may be burnt.

Check oil level

Pull out the oil gauge (A) and wipe off oil with a clean cloth. Reinsert and remove it again to see if the oil level is within the upper and lower marks.

If insufficient, add oil to reach to specified level zone (c). Never add oil more than upper limit. It may cause more oil consumption and carbon deposit in combustion system.



IMPORTANT

- 1) Park the tractor on a level place, apply parking brake and stop engine to check oil level. If the tractor is on an inclined place, oil level is not correct.
- 2) Check the oil level before engine starts or engine is cool. Never check oil level immediately after engine stops. Wait for at least 20 minutes.
- 3) Never dispose of oil in rivers, field or place that contaminate nature. Have the oil handled by professionals.

Replacing oil

Remove drain plug on the bottom of engine crankcase. Refill new oil through the oil supply port. Select a proper type of engine oil and replace it periodically.

Model	Capacity	Type
EF312T	4.7 lit.	CD or better grade
EF352T	4.7 lit.	SAE #30, #40

Replace
First 50hrs and every 100 hrs.

Engine oil filter

Replace
First 50hrs and every 300 hrs or every 2-3 times of replacing engine oil, which comes earlier.

Replacing engine oil filter

- (1) Drain engine oil.
- (2) Turn engine oil filter anticlockwise with a filter wrench.
- (3) Apply a little engine oil on the rubber ring on the bottom of the new filter and install it.
- (4) Refill engine oil and run the engine until engine oil pressure indicator lamp turns off.
- (5) Stop engine and wait for about 20 minutes or more to check the oil level. Add oil if necessary.

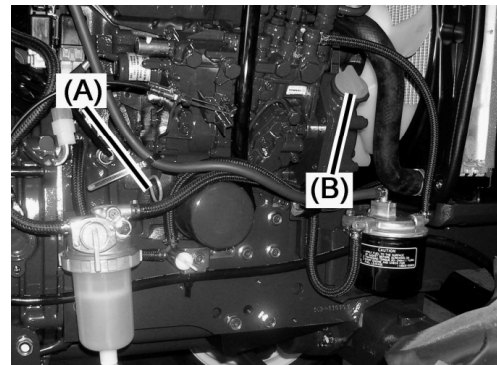

(A) Dipstick (B) Oil supply port

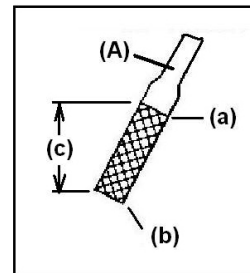

(A) Dipstick
(a) Upper limit (b) Lower limit
(c) Specified level zone

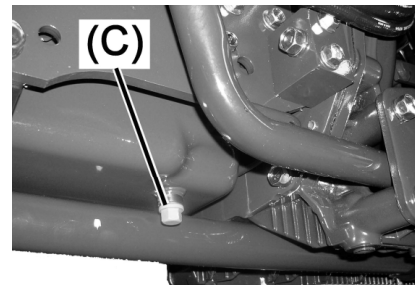

(C) Drain plug

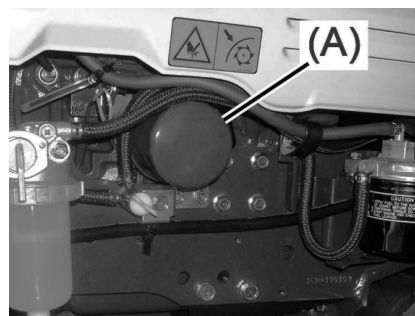

(A) Engine oil filter

6-2. Transmission-hydraulic oil and filter

The transmission oil functions as lubricant of transmission gears, brake discs and hydraulic system oil as well. The transmission oil quality and filter is very important to keep good condition of transmission and hydraulic system.

Check oil level

- (1) Check oil level at oil level window on backside of transmission. Adequate oil level is between a half of window and the lowest (L).
- (2) If the oil is no seen in oil level window, replenish oil.

Replacing oil

Remove drain plug and drain oil. When transmission is warm, draining oil is easier.

Oil Capacity

Model	Capacity	Replace
EF312T	25 lit.	First 50hrs and every 300 hrs.
EF352T	25 lit.	

Use Yanmar hydraulic-transmission fluid TF-500A or equivalent. Do not mix oil with other brand.

Equivalent oil

Supplier	Brand name
Mobil	Mobil Fluid 425
Castrol	Agricastrol MP
John Deere	J14A, J20B
ESSO	Torque Fluid 56
Shell	Shell Tellus Oil 32 or 37

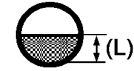
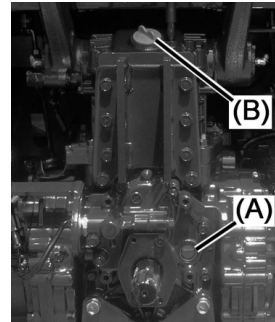

(A) Oil level window (B) Oil supply port
(L) Adequate oil level

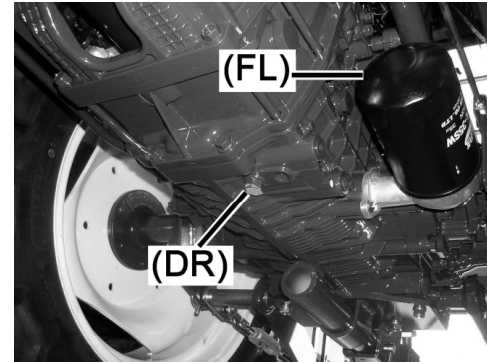

(DR) Transmission oil drain plug



IMPORTANT

When you install drain plug, pay attention not to break screw tread of transmission case. Transmission case is made of aluminum. Case itself has enough strength for normal works, but if you put a bolt improperly, screw tread is sometime broken easily. To install drain plug, screw the drain plug by hand first and when most of tread get in, tighten it by a wrench finally.

Transmission oil filter (Line filter)

Replace
First 50 hours and every 300 hours.

Replacement

- (1) Remove drain plug to drain oil.
- (2) Turn transmission oil filter anticlockwise with a filter wrench.
- (3) Apply a little transmission oil on the rubber ring on the bottom of the new filter and install it.
- (4) Refill transmission oil and run the engine for a few minutes
- (5) Stop engine and wait for about 20 minutes or more to check the oil level. Add oil if necessary.

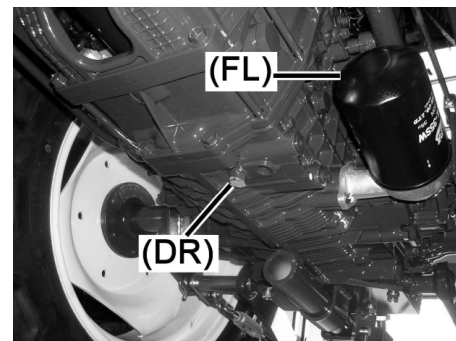

(FL) Transmission oil filter

6-3. Front axle oil

Check

Park the tractor on a level place.
 Hold yellow part of dipstick and turn it anti-clockwise to loosen screw. Pull out dipstick and wipe off oil. Insert dipstick without screwing, pull it out and check oil level. Oil level must be between upper and lower limit.



IMPORTANT

- 1) Park the tractor on a level place, apply parking brake and stop engine to check oil level. If the tractor is on an inclined place, oil level is not correct.
- 2) Never grip and remove metal part on the top of dipstick. The metal part is a breather and could be removed if you pull it up. If you lost the metal part, water gets into front axle case and it damages inner parts.

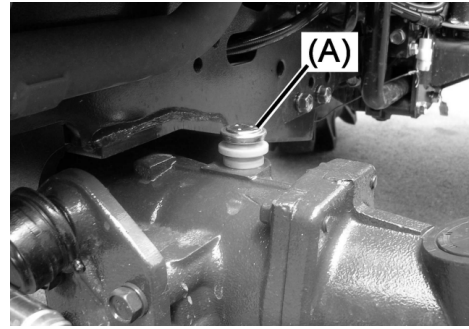

(A) Dipstick

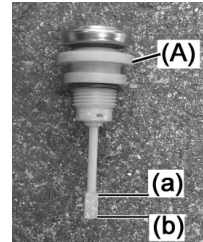

(A) Dipstick
 (a) Upper limit
 (b) Lower limit

Replacing oil

Drain plugs of front axle case are located on lower part of front axle gear case, both right and left individually. Remove both drain plugs to drain oil.

Model	Capacity	Oil type	Replace
EF312T	5.0 lit.	Gear oil SAE #90	First 50hrs and every 300 hrs.
EF352T	5.0 lit.		

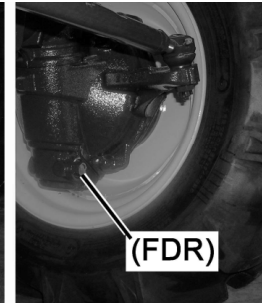
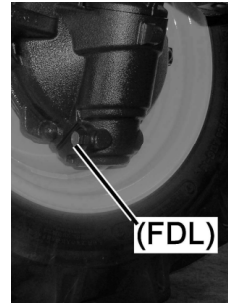

(FDL) Drain plug, left side
 (FDR) Drain plug, right side

7. Engine coolant



DANGER

Never open the radiator cap when the engine is hot. Hot steam and boiled water may blow out and you may suffer severe burns.

Check

Open the bonnet and check water level in the sub tank water is between "FULL" and "LOW" marks. If water is insufficient, add clean water.

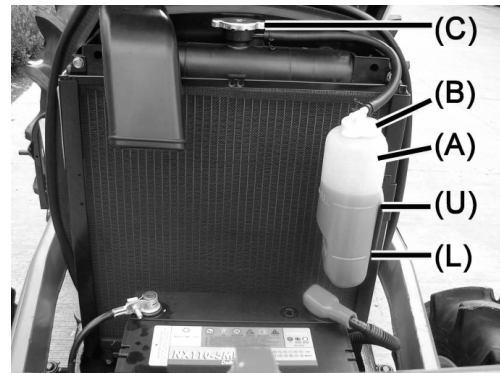

(A) Sub-tank (cooling water)
(B) Cooling water supply port
(C) Radiator cap
(U) Upper limit (FULL)
(L) Lower limit (LOW)

Replacing coolant

- (1) Remove the coolant drain plug and drain cooling water. It is easier for draining to open radiator cap.
- (2) Clean the inside of radiator with tap water until dust or rust does not come out. It is suggested to use radiator detergent. Fill radiator with water and detergent and run the engine in idle speed for more than 15 minutes. Drain the water.
- (3) Fill radiator with clean water. It is recommended to mix anticorrosive. Run the engine for about 5 minutes in idle speed to mix water and anticorrosive.

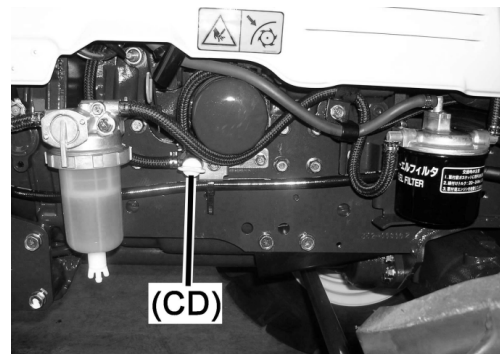

(CD) Coolant drain plug



IMPORTANT

The mixing ratio of anticorrosive varies depend on manufacturer. Follow the instruction of its manufacturer.

8. Bleeding fuel lines of air

If the engine stops due to lack of fuel or if the fuel strainer element or fuel piping has ever been detached for maintenance purpose, bleed air by the following procedure:

- (1) Fill up fuel tank if engine stop by short of fuel.
- (2) See the bowl of water separator is filled with fuel and fuel cock is open.
- (3) Pull accelerator lever backward to the maximum speed position.
- (4) Turn the main switch in the start position and run the starter motor for 5 - 10 seconds.

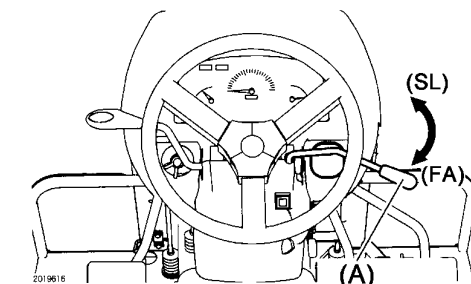

(A) Accelerator lever
(FA) Increase speed (higher speed)



IMPORTANT

Never run starter motor more than 10 seconds. It may cause breakage of starter motor. If you cannot start engine within 10 seconds, restart engine after 2-5 minutes.

9. Radiator screen

Radiator screen catches dust getting into radiator fins. If the screen is covered by dust, it causes engine over heat.

Check the screen before every work.

Open the bonnet and check radiator screen.

Pull up sub-tank and air intake pipe. Pull up radiator screen and clean it.

Be sure sub-tank and air intake pipe are returned to the positions properly.

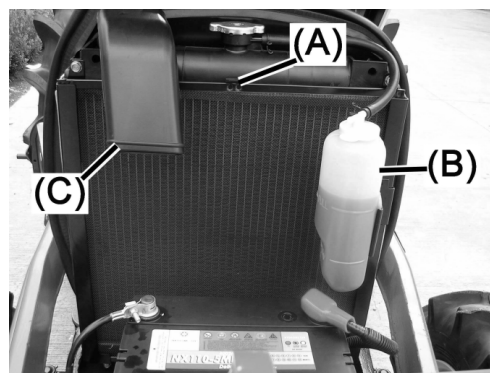

(A) Radiator screen
(B) Sub-tank
(D) Air intake pipe

10. Cleaning air cleaner elements (dual element)

The air cleaner serves to keep the engine in favorable conditions by removing dust in air and preventing the cylinder liner and piston ring from premature wearing.

For operation in a dusty environment, clean the air cleaner element every 50 hours or earlier and replace it every 400 hours or earlier.

For operation in a normal condition, clean it every 100 hours and replace it every 1000 hours or every year.

-) Lift the front end part of air cleaner.
- (2) Open the cap and take out the outer element. Tap dust out of the outer element. If much dust on the element, blow air from inside of the element. Be careful not to damage the fins.
- (3) Return the outer element, close the cap as "TOP" mark upward and clip firmly.
- (4) Push down the front end part of the air cleaner to the original position.

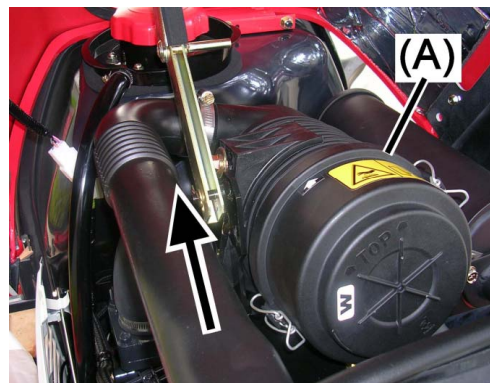

(A) Air cleaner



IMPORTANT

- 1) Do not take out the inner element. It avoid from getting dust into the engine air intake part. It is not necessary to replace inner element as long as no damage on it or too much dirty.
- 2) Never operate engine with inner element only. Inner element can not work as outer element.

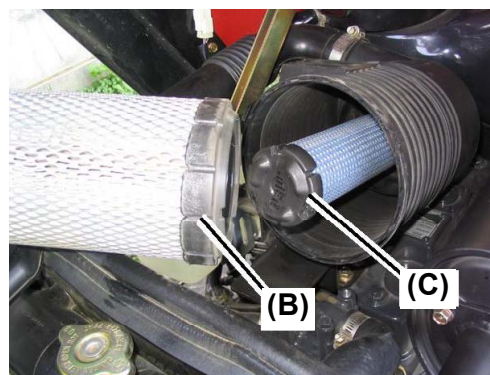

(B) Outer element
(C) Inner element

11. Checking battery



CAUTION

- 1) Battery electrolyte evaporates and hydrogen gas comes out. Hydrogen gas is flammable. Never smoke while handling battery. Keep all sparks and open flames away from battery. If hydrogen gas catches fire, battery will explode and cause serious injury.
- 2) Use flashlight to check battery electrolyte level. Never use open flame.
- 3) Make sure to disconnect battery ground cable before servicing any part of electrical system.
- 4) To remove battery, disconnect the ground (negative) cable first and disconnect positive cable. To install battery, connect the positive cable first and connect ground (negative) cable.



WARNING

Sulfuric acid in battery electrolyte is injurious and poisonous. It is strong enough to burn skin, eat holes in clothing, and cause blindness if it is splashed into eyes.

To avoid the hazards:

- (1) Filling battery in a well-ventilated area.
- (2) Wearing eye protection and rubber gloves.
- (3) Avoiding breathing fumes when electrolyte is added.
- (4) Avoiding spilling or dripping electrolyte.

If you spill acid on yourself:

- (1) Flush your skin with water.
- (2) Apply baking soda or lime to help neutralize the acid.
- (3) Flush your eyes with clean water for 10 - 15 minutes and get medical attention immediately.
- (4) If acid is swallowed, get medical attention immediately.

Battery of EF312T/EF352T

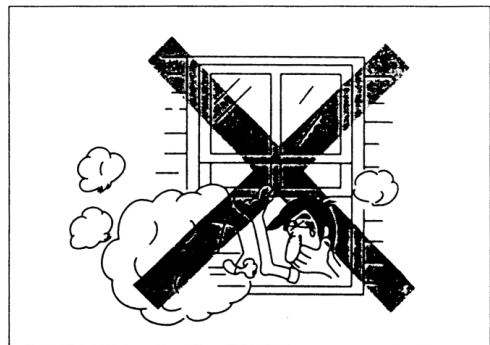
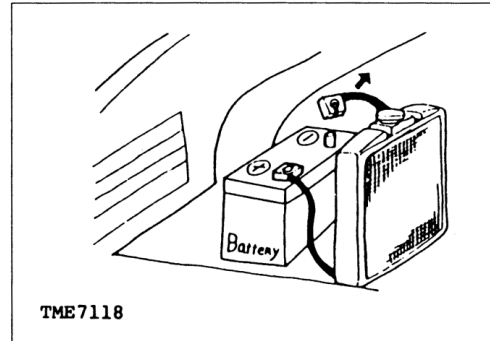
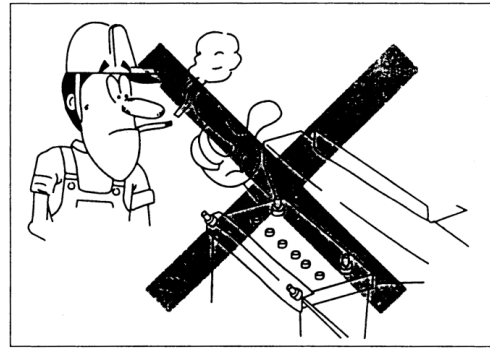

11-1. Check battery

This tractor is equipped with a calcium battery, sealed type at the factory. It is not required to refill battery electrolyte.

- (A) Negative (ground) terminal
- (B) Positive terminal
- (C) Hydrometer
- (D) Breather
- (E) Fixing nuts

Check battery charge conditions with hydrometer. Color in the hydrometer shows conditions.

Color	Charge status	Actions required
Green	Normal	Usable
Black	Discharged	Recharge.
Transparent	Low electrolyte level	End of service life. Replace the battery.

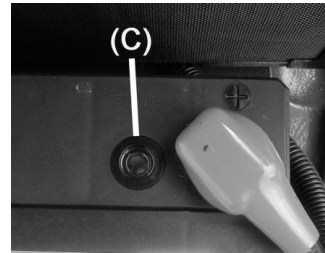
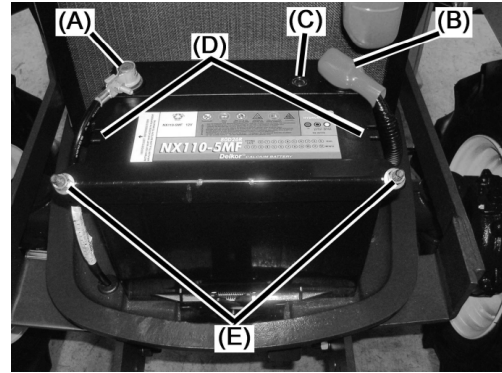

IMPORTANT

- 1) Make sure the tractor is level and check the hydrometer.
- 2) Check color right down on the hydrometer.
- 3) If the indicated color is transparent or pale green, lightly tap the battery to make sure of no bubbles and check it again.

11-2. Removing and installing battery

Remove

- (1) Open the bonnet.
- (2) Disconnect the negative (ground) cable from the battery and disconnect the positive cable.
- (3) Loosen fixing nuts and remove the battery.

Installation

- (1) Connect positive cable and negative cable.
- (2) Tighten fixing nut.

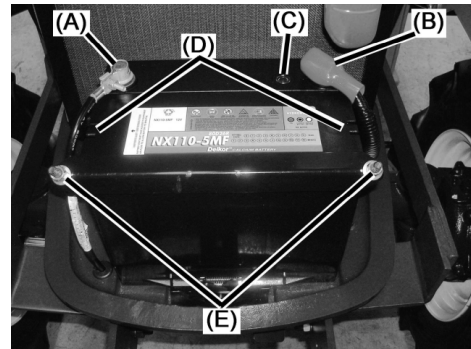

- (A) Negative (ground) cable
- (B) Positive cable
- (E) Fixing nuts



IMPORTANT

- 1) When connecting the battery cables, wipe oil away from the terminal contacts. After connecting cables, apply grease to the terminals.
- 2) Be sure to attach the rubber boots for the positive terminal of the battery.
- 3) When replacing the battery, be sure to use the genuine battery or equivalent specified in the right table
- 4) For environmental protection and recycle of resources, return the old battery following the regulation of your place.

Battery type of EF312T/EF352T

Model	Specified battery	Parts code No.
EF312T	80D26R or	1A7000-51540
EF352T	NX110-5MF	

Voltage	12 Volts
Capacity 5HR	55 AH
Charging rate	11 Amperes

11-3. Charging battery



DANGER

Never charge the battery with quick charger or fast charger. Internal pressure of the battery increases and the battery may explode. It may cause serious injury.



IMPORTANT

Charge the battery only when the color of hydrometer is black.

Charge the battery as following procedures.

- (1) Remove the battery.
- (2) Connect the battery positive cable to the positive side of the charger, the battery negative cable to the negative side of the charger.
- (3) Charge the battery at approximately 3 amperes for 8 to 10 hours. When the hydrometer color becomes green, charge is completed.
- (4) Install the battery to the tractor.

12. Checking pipes and hoses

Check fuel pipes, hydraulic power steering pipes and radiator hoses for leak and loose connections. It is recommended to replace such parts every two years.



DANGER

Aged or damaged pipes leak fuel or hydraulic oil and it may cause a fire. If a leak is found, replace the pipe with new one.

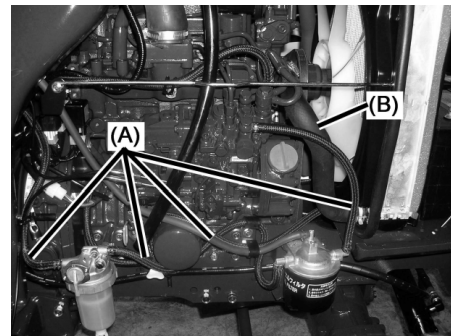

(A) Fuel pipe
(B) Radiator hose



(C) Radiator hose

13. Checking electrical wires

Open the bonnet and take off side covers. Check damage, loose connection. Check them every 50 hours or have them periodically checked every year.



WARNING

- 1) A damaged electric wire causes short circuit and it may cause a fire. Check before starting day's work.
- 2) Clear dust, weeds or rice straws away wires and connections before starting works. Those objects cause a short circuit and it may cause a fire.

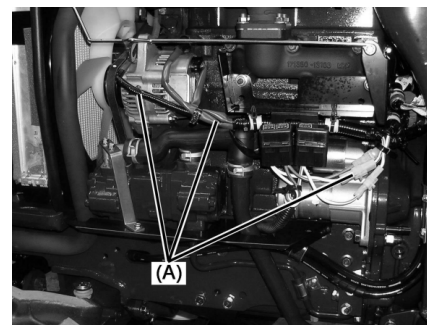

(A) Electric wires

14. Greasing

Before starting day's work, check the greasing condition at each point.
Apply grease normally every 50 hours.

Apply grease after every day's work when you work in wet paddy field.

(1) Tie rod end

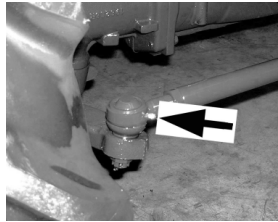

Tie rod end Left

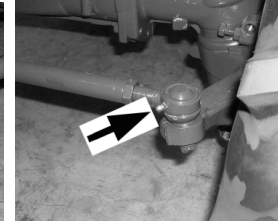

Right

(2) Power steering rod

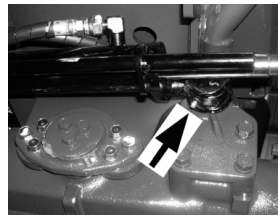

Power steering rod Left

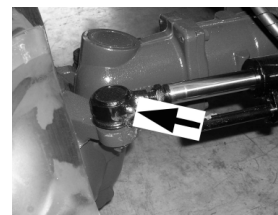

Right

(3) Center pin support

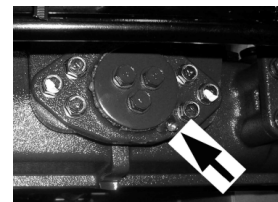

Center pin support Front

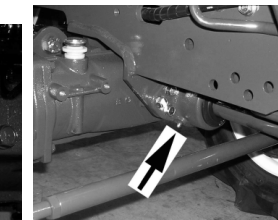

Rear

(4) Brake pedal shaft

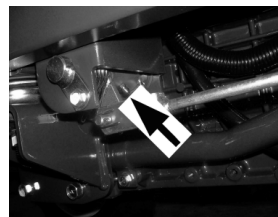

Brake pedal shaft Left

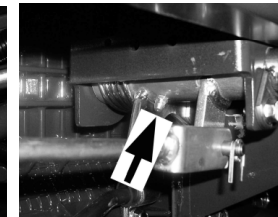

Right

(5) Lift arm shaft

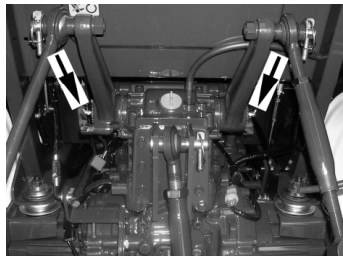

Lift arm shaft Left & Right

15. Adjusting brake



WARNING

- 1) Check free play of brake pedal before every work. If brake is not work properly, accident may occur.
- 2) Unequal free play of left and right brake can cause abrupt turn and it may cause injury. Keep the same amount of play. Otherwise, an accident can result.

Disconnect brake pedals if latched.

Push down right and left brake pedals one by one and check free play of each pedal to be 30-40mm. Both pedals must have the same free play.

Adjustment

- (1) Loosen lock nut of brake rod. Turn brake rod to adjust pedal free play to 30-40 mm. The free play of one pedal must equal to the other.
- (2) Make sure to tighten lock nut.



IMPORTANT

Make sure parking brake can be applied firmly.

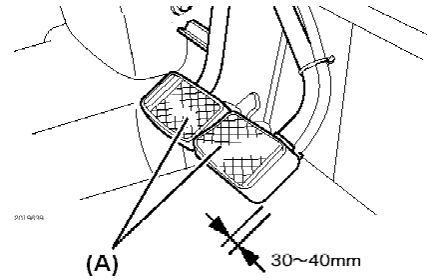

(A) Brake pedal

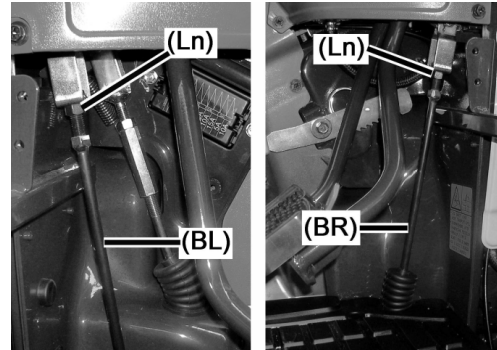

(BL) Brake rod, left (BR) Brake rod, right
(Ln) Lock nut

16. Adjusting clutch pedal

Push down the clutch pedal and check the free play. The specified free play of clutch pedal is 15-25 mm.



IMPORTANT

Do not rest foot on clutch pedal while operating. It may cause premature wearing of clutch disc.

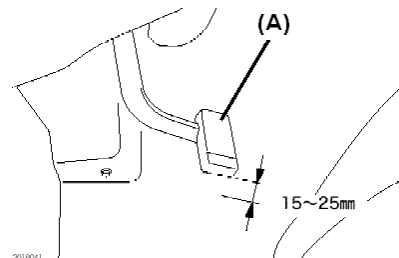

(A) Clutch pedal

Adjustment

- (1) Loosen lock nut. Turn the turnbuckle to adjust free play to 15-25 mm.
- (2) Tighten lock nut firmly.



IMPORTANT

- 1) When free play is less than 15 mm; Engagement of engine flywheel and clutch disc is not enough and it will cause premature wearing of clutch disc.
- 2) When free play is more than 25 mm; Disengagement of engine flywheel and clutch disc is not enough and it will cause noise when shifting gears. It also may cause damage on gears.

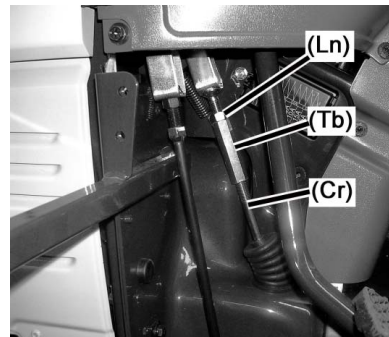

(Cr) Clutch rod
(Ln) Lock nut (Tb) Turnbuckle

17. Checking steering wheel



WARNING

Check free play of steering wheel. The normal free play is 20-50 mm.

This tractor is equipped with hydrostatic power steering and it causes less wearing of steering system. When free play is more than normal, check wearing of tie rod ends. The wearing of tie rod end causes more free play on steering wheel.

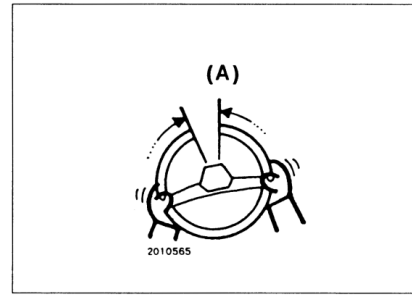

(A) Steering wheel free play. Measure the free play on wheel circle.

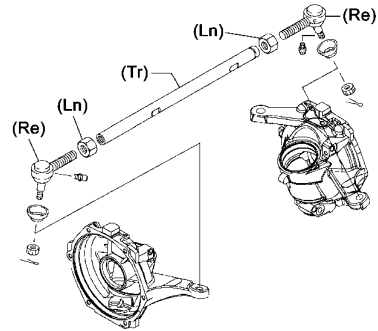

(Tr) Tie rod (Re) Tie rod end

18. Adjusting fan belt



CAUTION

Stop the engine and wait until the engine is sufficiently cooled down. Otherwise, you may be burned.

Check

Press the fan belt with a finger at the midpoint and see the belt deflections.

The specified deflection is 10 - 15 mm.

Adjustment

- (1) Open the bonnet and pull upper part of the left side cover and remove it.
- (2) Loosen generator bolt, belt adjuster bolt, and generator nut.
- (3) Move generator to stretch the belt tight. Tighten generator bolt and see deflection. If the deflection is 10 - 15 mm, tighten generator bolt, generator nut and belt adjuster bolt.



IMPORTANT

When tractor is new, fan belt stretched in a short time. Check belt deflection frequently.

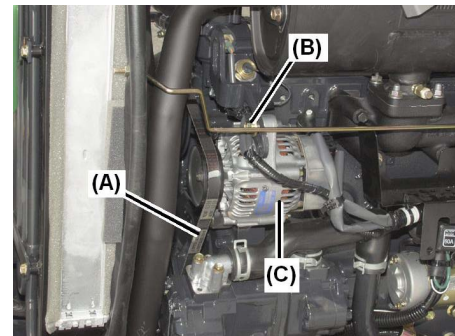

(A) Fan belt (B) Generator bolt.
(C) Generator

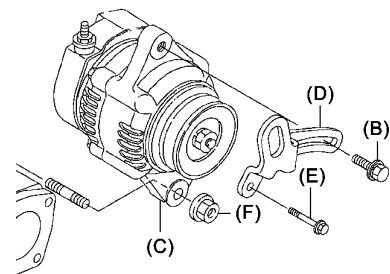

(B) Generator bolt (C) Generator
(D) Belt adjuster (E) Belt adjuster bolt
(F) Generator nut

19. Checking and adjusting toe-in

When a tractor runs, front wheels intend to go outward due to camber angle. The toe-in gives a counter force against outward force to run straight. If the toe-in is not adjusted appropriately, steering may not be stable.

Check

- (1) Put front wheel to be straight.
- (2) Measure the distance between the center of right tire and left tire in front side (b).
- (3) Measure the distance between the center of right tire and left tire in rear side (a).
- (4) See the difference.

The amount of (a) must be bigger than (b).

Specified toe-in: $a - b = 4 - 8 \text{ mm}$

Adjustment

- (1) Lift up front wheel slightly. It is not necessary that front tires are floating.
- (2) Loosen the lock nuts, left and right.
- (3) Turn tie rod to adjust the front wheel tread and measure front side and rear side of wheel tread.
- (4) When the toe-in is specified amount, tighten the lock nuts.

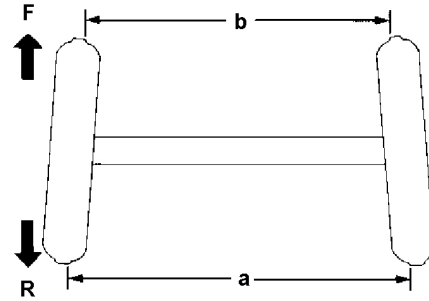

F: Forward

R: Rearward

a: distance between the center of tires, rear

b: distance between the center of tires, front

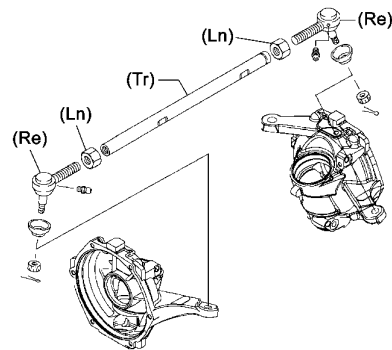

(Tr) Tie rod (Ln) Lock nut, right and left

20. Replacing fuse

20-1. Fuse box

The fuse box is located at left side of dashboard nearby clutch rod.

Remove fuse box caps and check fuses. Replace the blown fuse with new one.



CAUTION

Be sure to use a fuse of specified capacity. If a bigger capacity fuse is replaced, it may burn electric wire and cause a fire. Never use electric wire or iron wire etc. as a fuse.

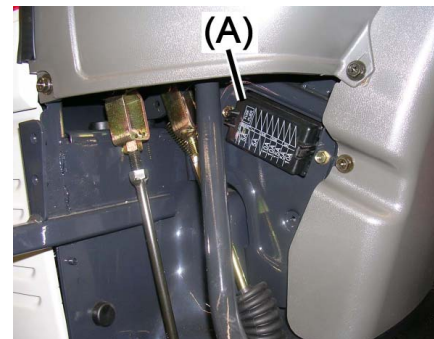

(A) Fuse box

(1)	5 A	Combination meter
(2)	5 A	Turn signal
(3)	10 A	Tail lamp
(4)	10 A	Meter lamps, gauges
(5)	15 A	Head light, horn, side lamp
(6)	5 A	Reverser neutral switch
(7)	10 A	Fuel stop start solenoid

Spare: 15 A, 10 A, 5 A

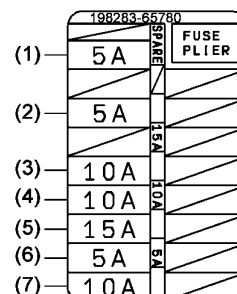

20-2. Slow blow fuse

Slow blow fuses are located on left side of the engine. The slow blow fuse protects main electric circuit that requires heavy current.



CAUTION

Be sure to use a genuine slow blow fuse. Never use electric wire or iron wire etc. as a fuse. It may cause a fire.

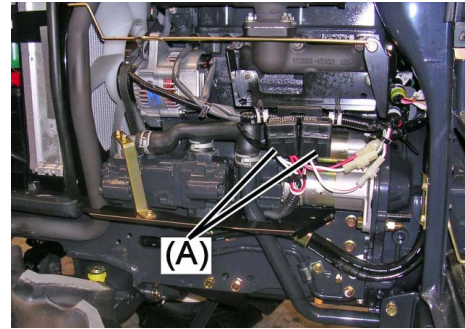

(A) Slow blow fuse

There are 3 slow blow fuses.

- 1) Alternator circuit
- 2) Main circuit
- 3) Start circuit

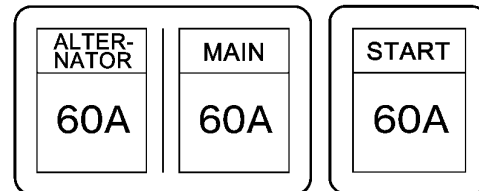

21. Checking tire and wheel

Check dairy damages, wear and air inflation of tires. Check dairy looseness of tire hub bolts and nuts. Check dairy crack and bent of wheel and rim.



WARNING

Never operate the tractor when a tire hub bolt or nut is loosened. It may cause injury if a tire is taken off while operating.

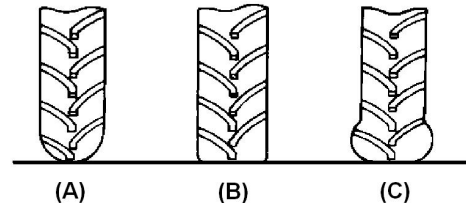

- (A): Excessive
(B): Standard
(C): Insufficient

Checking tires

Adjust the inflation pressures of the front and rear tires to the standard pressure. Also check for any crack or faults on the tires.

Standard inflation pressure of tire

	Tire size (ply)	Pressure Kpa (kgf/cm ²)
Front	7-14 (4)	180 (1.8)
Rear	11.2-24 (4)	120 (1.2)

EF312T, EF352T

Hub bolt and nut tightening torque

Tighten hub bolts and nuts with specified tightening torque. A rear wheel is fixed with 4 bolts and 2 nuts.

Tightening torque	Front wheel	118 to 147Nm (12 to 15kgf-m)
	Rear wheel	177 to 196Nm (18 to 20kgf-m)

EF312T, EF352T



IMPORTANT

Do not tighten more than specified torque. It may break screw tread and fixing would be insufficient. When a hub bolt or nut loosen frequently, check screw tread and replace if necessary.

22. Color of exhaust gas

The color of exhaust gas is black just after engine starts and it is gray or no color during operation.

Black: Incomplete combustion due to dense fuel.

White: Engine oil is burning.
Normal exhaust may look white at extremely low temperature.

If exhaust gas is black or white without a load on the tractor, consult with your service dealer.

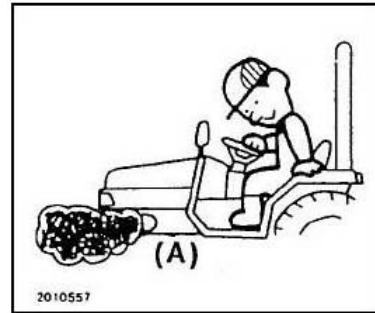

TROUBLESHOOTING

If abnormal operations are found, stop the engine and found a problem by referring to the following table.

1. Engine

PROBLEM		CAUSE	REMEDY
Engine hard to start or not start	Starter motor runs.	No fuel or improper fuel	Fill fuel. Drain wrong fuel and fill proper fuel.
		Water, dirt, or air in fuel system	Drain, flush & bleed fuel system.
		Clogged fuel filter	Clean or replace fuel filter.
		Fuel shut-off valve closed	Open fuel shut-off valve.
		Accelerator lever not pulled	Pull throttle lever.
		Engine oil too heavy	Use oil of proper viscosity.
	Starter motor doesn't run.	Reverser lever is not set to "N".	Set the lever to neutral.
		PTO shift lever is not set to "N".	Set the lever to neutral.
		Low voltage	Charge battery.
		Slow blow fuse blown	Replace slow blow fuse.
Engine runs irregularly or stalls frequently	Vent in fuel tank cap clogged	Clean cap in solvent and blow dry.	
	Fuel filter clogged	Clean or replace fuel filter.	
	Water, dirt, or air in fuel system	Drain, flush & bleed fuel system.	
	Dirty or faulty injection nozzles	See your YANMAR dealer.	
	Improper type of fuel	Use proper fuel.	
	Engine solenoid linkage out of adjustment	See your YANMAR dealer.	
	Insufficient oil	Add oil	
Engine knocks	Low coolant temperature	Remove and check glow plug.	
	Engine overheating	See "Engine overheats".	
	Idle speed too slow	Check idle speed.	
	Improper type of fuel	Use proper fuel.	
Lack of engine power	Engine overloaded	Reduce load or shift to lower gear.	
	Air cleaner element clogged	Clean air cleaner element.	
	Clogged fuel filter	Clean or replace fuel filter.	
	Improper type of fuel	Use proper fuel.	
	Engine overheating	See "Engine overheats".	
	Improper ballast	Adjust ballast to load.	
	Hydraulic stop valve closed	Open stop valve.	
	Improper implement mounted	Check required horsepower for implement.	

1. Engine (continued)

PROBLEM	CAUSE	REMEDY
Engine overheats	Engine overloaded	Reduce load or shift to lower gear.
	Low coolant level	Fill coolant and check cooling system for loose connections or leak.
	Loose or defective fan belt	Adjust fan belt and replace if needed
	Radiator screen or fins clogged	Clean radiator screen or fins.
	Cooling system needs flushing	Flush cooling system.
	Defective thermostat	Remove and check thermostat.
	Defective temperature gauge or sender	See your YANMAR dealer.
High oil consumption	Oil viscosity is too light	Use proper viscosity oil.
	Oil leaks	Check for leaks in lines, seals, drain plug and around gaskets.
Engine emits white smoke	Improper type of fuel	Use proper fuel.
	Low engine temperature	Warm up engine to normal operating temperature.
Engine emits black or gray smoke	Improper type of fuel	Use proper fuel.
	Engine overloaded	Reduce load or shift to lower gear.
	Air cleaner clogged	Clean or replace air cleaner element.
High fuel consumption	Improper type of fuel	Use proper fuel.
	Engine overloaded	Reduce load or shift to lower gear.
	Air cleaner clogged	Clean or replace air cleaner and element.
	Crankcase breather clogged	Clean breather pipe.
	Radiator screen or fins clogged	Clean radiator screen or fins.
	Improper implement mounted	Check required horsepower for implement.
	Tire pressure too low.	Inflate tires to proper pressure.
Clutch slipping.	Adjust clutch free travel or replace disk.	
Unusual noise	Defective component parts	See your YANMAR dealer.

2. Electrical system

PROBLEM	CAUSE	REMEDY
Battery not charged	Loose or corroded connections	Clean and tighten connections.
	Battery service life is ending	Check electrolyte level and specific gravity and replace if necessary.
	Loose or defective fan belt	Adjust belt tension or replace belt.
	Excessive engine idling	Allow engine to idle when necessary.
Charging indicator lamp lights during operation	Low engine speed	Increase speed.
	Defective battery	Check electrolyte level and specific gravity and replace if necessary.
	Loose or defective fan belt	Adjust belt tension or replace belt.
Engine oil pressure indicator lamp lights	Low oil	Add oil.

3. Hydraulic system

PROBLEM	CAUSE	REMEDY
Implement not raises	Low oil level	Fill system with proper oil.
	Hydraulic stop valve closed	Open stop valve.
	Excessive load on hitch	Reduce load.
	Hydraulic oil too cold	Allow oil to warm up.
	Hydraulic oil filter clogged	Replace filter.
	Defective hydraulic pump or control valve	See your YANMAR dealer.
	Oil leaks	Check oil leaks.
Hitch drops slowly or does not drop	Hydraulic stop valve closed	Open stop valve.
	Slow return valve set slow	Open valve and adjust drop speed.
System drops too fast	Slow return valve set fast	Close valve and adjust drop speed.
	Improper oil	Use oil with proper viscosity.
System overheating	Incorrect oil viscosity	Drain and fill oil with proper viscosity.
	Low oil level	Fill to proper oil level.
	Dirty oil	Drain and fill clean oil.
	Keeping steering wheel at the end	Release steering wheel.
	Control lever not returned to neutral position when using implement	Return lever to neutral position.

4. Power train

PROBLEM	CAUSE	REMEDY
Abnormal noise	Transmission oil level low	Add proper type of oil.
	Worn or broken gears/bearings	See your YANMAR dealer.
Tractor is pulled to one side	Brakes adjusted unevenly	Adjust brake pedal free travel.
	Right and left tires inflated unevenly	Inflate tires to proper pressure.
	Implement improperly adjusted	See implement operator's manual

SPECIFICATIONS

Model		EF312T(4WD)	EF352T(4WD)	
Engine	Make	Yanmar		
	Model	3TNV84	3TNV88	
	Type	Direct injection, Water cooled, diesel		
	Output	SAE Gross (hp)	30.1	34.5
		SAE Gross (ps)	30.5	35.0
	Rated RPM (rpm)	2500	2600	
	No. of cylinders	3		
	Displacement (cc)	1,496 cc	1,642 cc	
Fuel tank (lit.)	28			
Dimension	Overall length (mm)	2850		
	Overall width (mm)	1325		
	Overall height (steering wheel) (mm)	1365		
	Tread	Front (mm)	1000	
		Rear (mm)	1025, 1105	
	Wheelbase (mm)	1600		
Ground clearance (mm)	350			
Weight (kg)	920	920		
Tire size	Front	7 - 14	7 - 14	
	Rear	11.2 - 24	11.2 - 24	
Steering	Hydrostatic power steering			
Brake	Wet multi-disc type			
Clutch	Dry single			
Transmission	No. of shifting gears	8 forward and 8 reverse (constant & sliding mesh)		
	Reverser	Synchro-mesh		
	Travel speed	Forward (km/hr)	1.29 – 22.5	1.34 – 23.4
		Reverse (km/hr)	1.26 - 22.1	1.31 – 23.0
Turning radius (m)	2.2			
PTO	Gear 1	540 rpm	560 rpm	
	Gear 2	785 rpm	815 rpm	
Hydraulic system	Type	Position control		
	Hitch	3-point hitch		
	Category	Category 1		
	Max. lifting capacity (at lower link end) (kg)	1000		
	Hydraulic pump capacity (lit./min)	22	23	

Note:

All technical data, measurement and weight are approximate, and the manufacturer has the right to make alteration without prior notice.



YANMAR AGRICULTURAL EQUIPMENT CO., LTD.

1-32, Chayamachi, Kita-ku, OSAKA 530-8321, JAPAN
Tel : 06-6376-6336~8 Fax : 06-6373-9474

Revised April 2007
PRINTED IN JAPAN

OPE_EF312T&352T_en.doc